

Data sheet | Item number: 2001-1408

4-conductor shield terminal block; 1.5 mm²; side and center marking; for DIN-rail 35 x 15 and 35 x 7.5; Push-in CAGE CLAMP®; 1,50 mm²; white

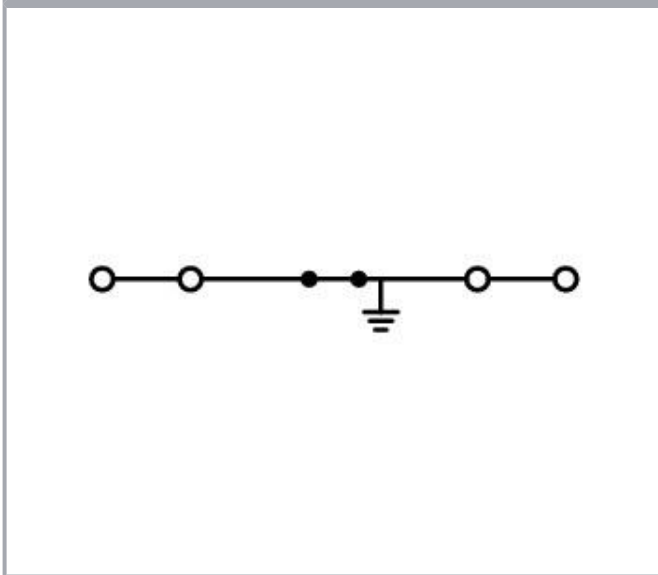

www.wago.com/2001-1408

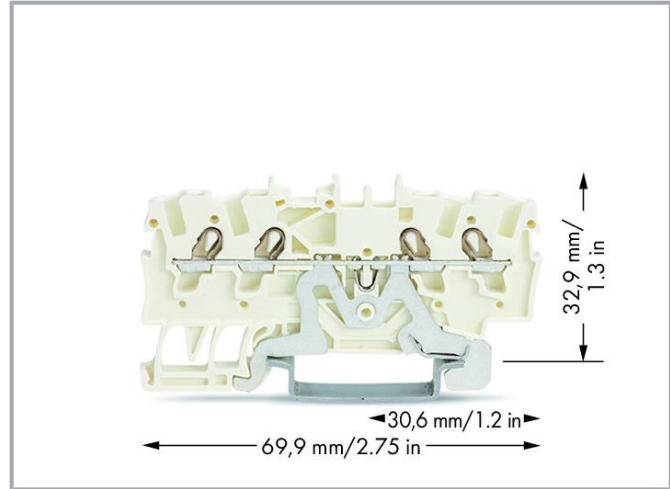

Data

Electrical data

Ratings per IEC/EN

Ratings per

IEC/EN 60947-7-2

Subject to changes. Please also observe the further product documentation!

WAGO GmbH & Co. KG
Hansastr. 27
32423 Minden
Phone: +49571 887-0 | Fax: +49571 887-169
Email: info.de@wago.com | Web: www.wago.com

Do you have any questions about our products?
We are always happy to take your call at +49 (571) 887-44222.



Connection data

Connection points	4
Total number of potentials	1
Number of levels	1
Number of jumper slots	2

Connection 1

Connection technology	Push-in CAGE CLAMP®
Actuation type	Operating tool
Connectable conductor materials	Copper
Nominal cross-section	1.5 mm ²
Solid conductor	0.25 ... 2.5 mm ² / 22 ... 14 AWG
Solid conductor; push-in termination	0.75 ... 2.5 mm ² / 18 ... 14 AWG
Fine-stranded conductor	0.25 ... 2.5 mm ² / 22 ... 14 AWG
Fine-stranded conductor; with insulated ferrule	0.25 ... 1.5 mm ² / 22 ... 16 AWG
Fine-stranded conductor; with ferrule; push-in termination	0.75 ... 1.5 mm ² / 18 ... 16 AWG
Note (conductor cross-section)	Depending on the conductor characteristic, a conductor with a smaller cross-section can also be inserted via push-in termination.
Strip length	9 ... 11 mm / 0.35 ... 0.43 inches
Wiring direction	Front-entry wiring

Physical data

Width	4.2 mm / 0.165 inches
Height	69.9 mm / 2.752 inches
Depth from upper-edge of DIN-rail	32.9 mm / 1.295 inches

Mechanical Data

Mounting type	DIN-35 rail
Marking level	Center/side marking

Material Data

Note (material data)	Information on material specifications can be found here
Color	white
Material group	I

Subject to changes. Please also observe the further product documentation!



Insulation material	Polyamide (PA66)
Flammability class per UL94	V0
Fire load	0.102 MJ
Weight	8.3 g

Environmental requirements

Processing temperature	-35 ... +85 °C
Continuous operating temperature	-60 ... +105 °C

Commercial data



Product Group	22 (TOPJOB S)
eCl@ss 10.0	27-14-11-41
eCl@ss 9.0	27-14-11-41
ETIM 8.0	EC000901
ETIM 7.0	EC000901
PU (SPU)	100 pcs
Packaging type	box
Country of origin	DE
GTIN	4045454719487
Customs tariff number	85369010000

Environmental Product Compliance

RoHS Compliance Status	Compliant, No Exemption
------------------------	-------------------------

Approvals / Certificates

General approvals



Logo	Approval	Additional Approval Text	Certificate name
	CCA DEKRA Certification B.V.	EN 60947	NTR NL-7963
	CSA DEKRA Certification B.V.	C22.2 No. 158	1645434
	KEMA/KEUR DEKRA Certification B.V.	EN 60947	71-125954

Subject to changes. Please also observe the further product documentation!





	UL UL International Germany GmbH	UL 1059	E45172
--	-------------------------------------	---------	--------

Declarations of conformity and manufacturer's declarations

Logo	Approval	Additional Approval Text	Certificate name
	EU-Declaration of Conformity WAGO GmbH & Co. KG	-	-
	Railway WAGO GmbH & Co. KG	-	Railway Ready
	UK-Declaration of Conformity WAGO GmbH & Co. KG	-	-

Approvals for marine applications

Logo	Approval	Additional Approval Text	Certificate name
	ABS American Bureau of Shipping	EN 60947	20-HG1941090-PDA
	BV Bureau Veritas S.A.	EN 60947	38586/B0 BV
	DNV GL Det Norske Veritas, Germanischer Lloyd	-	TAE00001V2

Required accessories

End plate

Subject to changes. Please also observe the further product documentation!

WAGO GmbH & Co. KG
Hansastr. 27
32423 Minden
Phone: +49571 887-0 | Fax: +49571 887-169
Email: info.de@wago.com | Web: www.wago.com

Do you have any questions about our products?
We are always happy to take your call at +49 (571) 887-44222.

End plate

**Item no.: 2002-1492**

End and intermediate plate; 0.8 mm thick; orange

www.wago.com/2002-1492**Item no.: 2002-1491**

End and intermediate plate; 0.8 mm thick; gray

www.wago.com/2002-1491

Optional accessories

Carrier rail

Mounting accessories

**Item no.: 210-197**

Steel carrier rail; 35 x 15 mm; 1.5 mm thick; 2 m long; slotted; similar to EN 60715; silver-colored

www.wago.com/210-197**Item no.: 210-198**

Copper carrier rail; 35 x 15 mm; 2.3 mm thick; 2 m long; unslotted; according to EN 60715; copper-colored

www.wago.com/210-198**Item no.: 210-113**

Steel carrier rail; 35 x 7.5 mm; 1 mm thick; 2 m long; unslotted; according to EN 60715; silver-colored

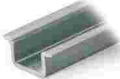
www.wago.com/210-113**Item no.: 210-118**

Steel carrier rail; 35 x 15 mm; 2.3 mm thick; 2 m long; unslotted; according to EN 60715; silver-colored

www.wago.com/210-118**Item no.: 210-112**

Steel carrier rail; 35 x 7.5 mm; 1 mm thick; 2 m long; slotted; according to EN 60715; "Hole width 25 mm; silver-colored

www.wago.com/210-112**Item no.: 210-114**

Steel carrier rail; 35 x 15 mm; 1.5 mm thick; 2 m long; unslotted; similar to EN 60715; silver-colored

www.wago.com/210-114**Item no.: 210-115**

Steel carrier rail; 35 x 7.5 mm; 1 mm thick; 2 m long; slotted; according to EN 60715; "Hole width 18 mm; silver-colored

www.wago.com/210-115**Item no.: 210-196**

Aluminum carrier rail; 35 x 8.2 mm; 1.6 mm thick; 2 m long; unslotted; similar to EN 60715; silver-colored

www.wago.com/210-196

Protective warning marker

Cover

**Item no.: 2001-115**

Protective warning marker; for 5 terminal blocks; with high-voltage symbol, black; yellow

www.wago.com/2001-115

Marking accessories

Marking strip

**Item no.: 2009-110**

Marking strips; for Smart Printer; on reel; not stretchable; plain; snap-on type; white

www.wago.com/2009-110

Marker

Subject to changes. Please also observe the further product documentation!

WAGO GmbH & Co. KG

Hansastr. 27













32423 Minden

Phone: +49571 887-0 | Fax: +49571 887-169

Email: info.de@wago.com | Web: www.wago.com

Do you have any questions about our products?

We are always happy to take your call at +49 (571) 887-44222.

	<p>Item no.: 2009-114/000-002 WMB-Inline; for Smart Printer; 2000 pieces on roll; stretchable 4 - 4.2 mm; plain; snap-on type; yellow</p>	<p>www.wago.com/2009-114/000-002</p>
	<p>Item no.: 2009-114/000-005 WMB-Inline; for Smart Printer; 2000 pieces on roll; stretchable 4 - 4.2 mm; plain; snap-on type; red</p>	<p>www.wago.com/2009-114/000-005</p>
	<p>Item no.: 2009-114/000-007 WMB-Inline; for Smart Printer; 2000 pieces on roll; stretchable 4 - 4.2 mm; plain; snap-on type; gray</p>	<p>www.wago.com/2009-114/000-007</p>
	<p>Item no.: 2009-114/000-023 WMB-Inline; for Smart Printer; 2000 pieces on roll; stretchable 4 - 4.2 mm; plain; snap-on type; green</p>	<p>www.wago.com/2009-114/000-023</p>
	<p>Item no.: 2009-114/000-006 WMB-Inline; for Smart Printer; 2000 pieces on roll; stretchable 4 - 4.2 mm; plain; snap-on type; blue</p>	<p>www.wago.com/2009-114/000-006</p>
	<p>Item no.: 2009-114/000-024 WMB-Inline; for Smart Printer; 2000 pieces on roll; stretchable 4 - 4.2 mm; plain; snap-on type; violet</p>	<p>www.wago.com/2009-114/000-024</p>
	<p>Item no.: 2009-114/000-012 WMB-Inline; for Smart Printer; 2000 pieces on roll; stretchable 4 - 4.2 mm; plain; snap-on type; orange</p>	<p>www.wago.com/2009-114/000-012</p>
	<p>Item no.: 2009-114 WMB-Inline; for Smart Printer; 2000 pieces on roll; stretchable 4 - 4.2 mm; plain; snap-on type; white</p>	<p>www.wago.com/2009-114</p>
	<p>Item no.: 793-4501/000-002 WMB marking card; as card; stretchable 4 - 4.2 mm; plain; snap-on type; yellow</p>	<p>www.wago.com/793-4501/000-002</p>
	<p>Item no.: 793-4501/000-006 WMB marking card; as card; stretchable 4 - 4.2 mm; plain; snap-on type; blue</p>	<p>www.wago.com/793-4501/000-006</p>
	<p>Item no.: 793-4501 WMB marking card; as card; stretchable 4 - 4.2 mm; plain; snap-on type; white</p>	<p>www.wago.com/793-4501</p>
	<p>Item no.: 793-4501/000-023 WMB marking card; as card; stretchable 4 - 4.2 mm; plain; snap-on type; green</p>	<p>www.wago.com/793-4501/000-023</p>

Subject to changes. Please also observe the further product documentation!



Item no.: 793-4501/000-024
WMB marking card; as card; stretchable 4 - 4.2 mm; plain; snap-on type; violet

www.wago.com/793-4501/000-024



Item no.: 793-4501/000-005
WMB marking card; as card; stretchable 4 - 4.2 mm; plain; snap-on type; red

www.wago.com/793-4501/000-005



Item no.: 793-4501/000-007
WMB marking card; as card; stretchable 4 - 4.2 mm; plain; snap-on type; gray

www.wago.com/793-4501/000-007



Item no.: 793-4501/000-012
WMB marking card; as card; stretchable 4 - 4.2 mm; plain; snap-on type; orange

www.wago.com/793-4501/000-012



Item no.: 793-4501/000-017
WMB marking card; as card; stretchable 4 - 4.2 mm; plain; snap-on type; light green

www.wago.com/793-4501/000-017

Testing and measuring

Testing accessories



Item no.: 2009-174
Test plug adapter; for 4 mm Ø test plugs; for testing TOPJOB®S rail-mounted terminal blocks; gray

www.wago.com/2009-174



Item no.: 2009-182
Testing tap; for max. 2.5 mm²; tool-free connection for individual test wires 0.08 - 2.5 mm; gray

www.wago.com/2009-182



Item no.: 2001-511
Modular TOPJOB®S connector; modular; for jumper contact slot; 1-pole; 1,50 mm²; gray

www.wago.com/2001-511



Item no.: 2001-554
Modular TOPJOB®S connector; modular; for jumper contact slot; 4-pole; 1,50 mm²; gray

www.wago.com/2001-554



Item no.: 2001-549
Spacer module; modular; e.g., for bridging commoned terminal blocks; gray

www.wago.com/2001-549



Item no.: 2001-556
Modular TOPJOB®S connector; modular; for jumper contact slot; 6-pole; 1,50 mm²; gray

www.wago.com/2001-556



Item no.: 2001-557
Modular TOPJOB®S connector; modular; for jumper contact slot; 7-pole; 1,50 mm²; gray





www.wago.com/2001-557







Item no.: 2001-553
Modular TOPJOB®S connector; modular; for jumper contact slot; 3-pole; 1,50 mm²; gray

www.wago.com/2001-553



Subject to changes. Please also observe the further product documentation!

	Item no.: 2001-552 Modular TOPJOB®S connector; modular; for jumper contact slot; 2-pole; 1,50 mm ² ; gray	www.wago.com/2001-552
	Item no.: 2001-558 Modular TOPJOB®S connector; modular; for jumper contact slot; 8-pole; 1,50 mm ² ; gray	www.wago.com/2001-558
	Item no.: 2001-560 Modular TOPJOB®S connector; modular; for jumper contact slot; 10-pole; 1,50 mm ² ; gray	www.wago.com/2001-560
	Item no.: 2001-555 Modular TOPJOB®S connector; modular; for jumper contact slot; 5-pole; 1,50 mm ² ; gray	www.wago.com/2001-555
	Item no.: 2001-559 Modular TOPJOB®S connector; modular; for jumper contact slot; 9-pole; 1,50 mm ² ; gray	www.wago.com/2001-559

Ferrule

Ferrule		
	Item no.: 216-241 Ferrule; Sleeve for 0.5 mm ² / 20 AWG; insulated; electro-tin plated; electrolytic copper; gastight crimped; acc. to DIN 46228, Part 4/09.90; white	www.wago.com/216-241
	Item no.: 216-242 Ferrule; Sleeve for 0.75 mm ² / 18 AWG; insulated; electro-tin plated; electrolytic copper; gastight crimped; acc. to DIN 46228, Part 4/09.90; gray	www.wago.com/216-242
	Item no.: 216-243 Ferrule; Sleeve for 1 mm ² / AWG 18; insulated; electro-tin plated; electrolytic copper; gastight crimped; acc. to DIN 46228, Part 4/09.90; red	www.wago.com/216-243
	Item no.: 216-244 Ferrule; Sleeve for 1.5 mm ² / AWG 16; insulated; electro-tin plated; electrolytic copper; gastight crimped; acc. to DIN 46228, Part 4/09.90; black	www.wago.com/216-244

Tool

Operating tool		
	Item no.: 210-648 Operating tool; Blade: 2.5 x 0.4 mm; with a partially insulated shaft; angled; short	www.wago.com/210-648
	Item no.: 210-647 Operating tool; Blade: 2.5 x 0.4 mm; with a partially insulated shaft; multicoloured	www.wago.com/210-647
	Item no.: 210-719 Operating tool; Blade: 2.5 x 0.4 mm; with a partially insulated shaft	www.wago.com/210-719







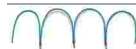

Insulation stop

Insulation stop		
	Item no.: 2001-171 Insulation stop; 0.25 - 0.5 mm ² ; 5 pieces/strip; light gray	www.wago.com/2001-171





Jumpers

Subject to changes. Please also observe the further product documentation!

Jumper

	Item no.: 210-123 Wire commoning chain; insulated; blue	www.wago.com/210-123
	Item no.: 2001-402 Jumper; 2-way; insulated; light gray	www.wago.com/2001-402
	Item no.: 2001-403 Jumper; 3-way; insulated; light gray	www.wago.com/2001-403
	Item no.: 2001-405 Jumper; 5-way; insulated; light gray	www.wago.com/2001-405
	Item no.: 2001-406/020-000 Delta jumper; insulated; light gray	www.wago.com/2001-406/020-000
	Item no.: 2001-405/011-000 Star point jumper; 3-way; insulated; light gray	www.wago.com/2001-405/011-000
	Item no.: 2001-407 Jumper; 7-way; insulated; light gray	www.wago.com/2001-407
	Item no.: 2001-409 Jumper; 9-way; insulated; light gray	www.wago.com/2001-409
	Item no.: 2001-406 Jumper; 6-way; insulated; light gray	www.wago.com/2001-406
	Item no.: 2001-404 Jumper; 4-way; insulated; light gray	www.wago.com/2001-404
	Item no.: 2001-410 Jumper; 10-way; insulated; light gray	www.wago.com/2001-410
	Item no.: 2001-433 Jumper; from 1 to 3; insulated; light gray	www.wago.com/2001-433
	Item no.: 2001-435 Jumper; from 1 to 5; insulated; light gray	www.wago.com/2001-435
	Item no.: 2001-408 Jumper; 8-way; insulated; light gray	www.wago.com/2001-408
	Item no.: 2001-437 Jumper; from 1 to 7; insulated; light gray	www.wago.com/2001-437
	Item no.: 2001-436 Jumper; from 1 to 6; insulated; light gray	www.wago.com/2001-436
	Item no.: 2001-440 Jumper; from 1 to 10; insulated; light gray	www.wago.com/2001-440

Subject to changes. Please also observe the further product documentation!

	Item no.: 2001-438 Jumper; from 1 to 8; insulated; light gray	www.wago.com/2001-438
	Item no.: 2001-434 Jumper; from 1 to 4; insulated; light gray	www.wago.com/2001-434
	Item no.: 2001-439 Jumper; from 1 to 9; insulated; light gray	www.wago.com/2001-439
	Item no.: 210-103 Wire commoning chain; insulated; black	www.wago.com/210-103

Mounting

Cover carrier





	Item no.: 709-169 Cover carrier; Type 3; gray	www.wago.com/709-169
--	---	--

Cover

	Item no.: 709-156 Cover; Type 3; suitable for cover carrier, type 3; 1 m long; transparent	www.wago.com/709-156
--	--	--

Push-in type wire jumper

Jumper

	Item no.: 2009-412 Push-in type wire jumper; insulated; 60 mm long; black	www.wago.com/2009-412
	Item no.: 2009-414 Push-in type wire jumper; 1.5 mm ² ; insulated; 110 mm long; black	www.wago.com/2009-414
	Item no.: 2009-416 Push-in type wire jumper; 1.5 mm ² ; insulated; 250 mm long; black	www.wago.com/2009-416
	Item no.: 2009-414/000-005 Push-in type wire jumper; 1.5 mm ² ; insulated; 110 mm long; black	www.wago.com/2009-414/000-005
	Item no.: 2009-414/000-006 Push-in type wire jumper; insulated; 110 mm long; black	www.wago.com/2009-414/000-006

Downloads

Documentation

Bid Text

2001-1408	2019 Feb 19	xml	Download
X81 - Datei		3.6 kB	

2001-1408

Subject to changes. Please also observe the further product documentation!

WAGO GmbH & Co. KG
 Hansastr. 27
 32423 Minden
 Phone: +49571 887-0 | Fax: +49571 887-169
 Email: info.de@wago.com | Web: www.wago.com

Do you have any questions about our products?
 We are always happy to take your call at +49 (571) 887-44222.



docx - Datei	2018 Aug 2	docx 14.7 kB	Download
--------------	------------	-----------------	----------

Additional Information

Technical Section Technical explanations		pdf 2.2 MB	Download
---	--	---------------	----------

CAD/CAE-Data

CAD data

2D/3D Models 2001-1408		URL	Download
------------------------	--	-----	----------

CAE data

EPLAN Data Portal 2001-1408		URL	Download
-----------------------------	--	-----	----------

WSCAD Universe 2001-1408		URL	Download
--------------------------	--	-----	----------

ZUKEN Portal 2001-1408		URL	Download
------------------------	--	-----	----------

Environmental Product Compliance

Compliance Search

Environmental Product Compliance 2001-1408		URL	Download
--	--	-----	----------

4-conductor shield terminal block; 1.5 mm²; side and center marking; for DIN-rail 35 x 15 and 35 x 7.5; Push-in CAGE CLAMP®; 1,50 mm²; white

Installation Notes

Conductor termination

Subject to changes. Please also observe the further product documentation!

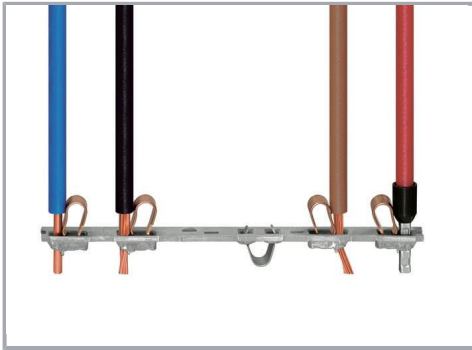

All conductor types at a glance

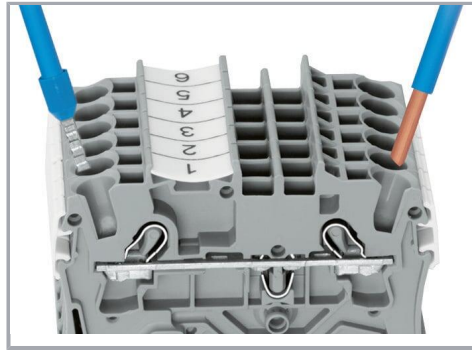

Push-in termination of solid and ferruled conductors

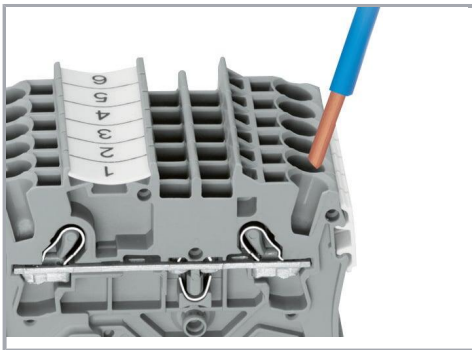

Inserting a conductor via push-in termination:

Solid conductors with cross-sections from either one size above, or up to two sizes below, the rated cross-section can be simply pushed in – no tools needed.

Subject to changes. Please also observe the further product documentation!

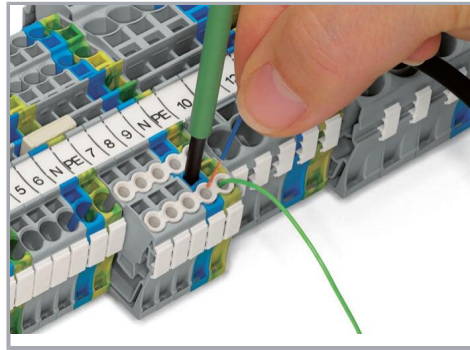
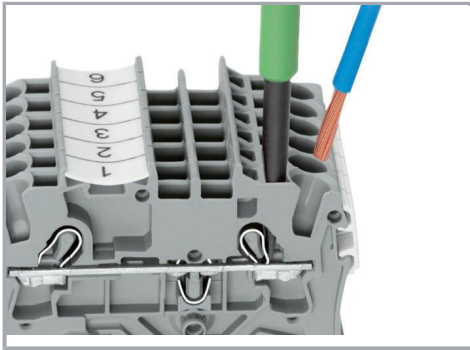

Inserting a conductor via operating tool:

Conductor termination – insulation stop

Connecting fine-stranded conductors without ferrules, or small cross-sectional conductors that cannot be pushed in, is performed similarly to the original CAGE CLAMP® – just use an operating tool.

Advantage:

To open the clamp, the operating tool is inserted vertically. The conductor entry is less than 15 degrees for easier wiring.

Commoning

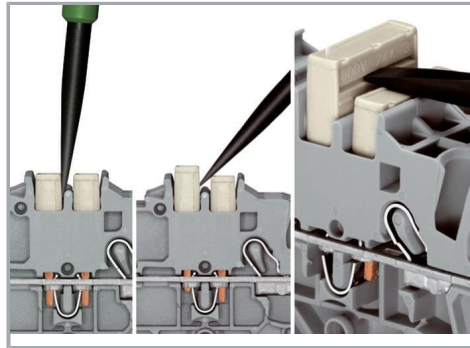
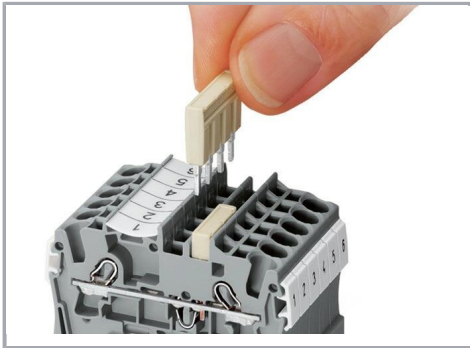

Insert push-in type jumper bar and push down until it hits backstop.

Removing a push-in type jumper bar:

Insert the operating tool between the jumper and partition wall of the dual jumper slots, then lift up the jumper.

Place the operating tool in the center of jumpers for up to five contacts (see above), or alternately on both sides for jumpers with more than five contacts.

Subject to changes. Please also observe the further product documentation!

Commoning

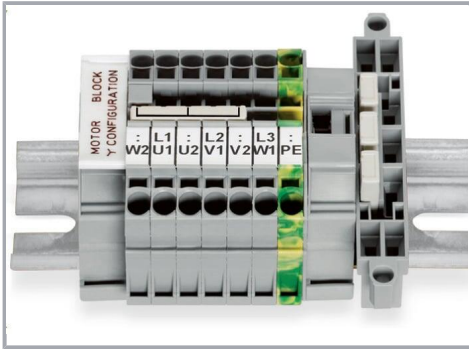

This star point jumper has been specially developed to create a "star point" and is used on motor terminal boards equipped with Rail-Mount Terminal Blocks TOPJOB® S.

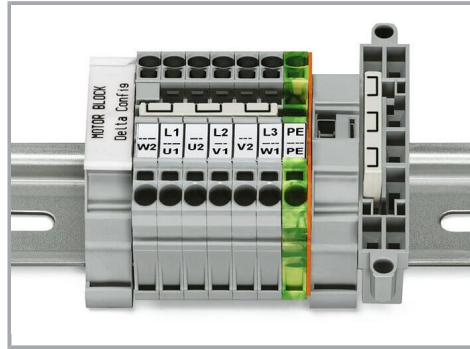

This delta jumper has been specially developed to create a delta configuration and is used on motor terminal boards equipped with rail-mount terminal blocks TOPJOB® S.

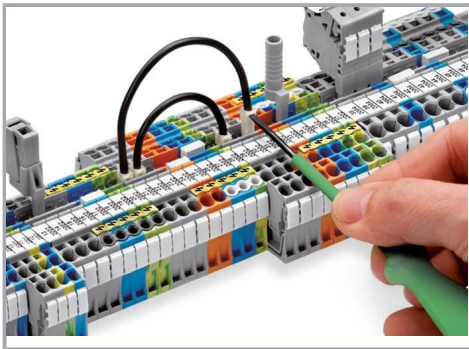

Push down the wire jumper until fully inserted.
Lift the jumper with an operating tool for rewiring.

Testing

Subject to changes. Please also observe the further product documentation!

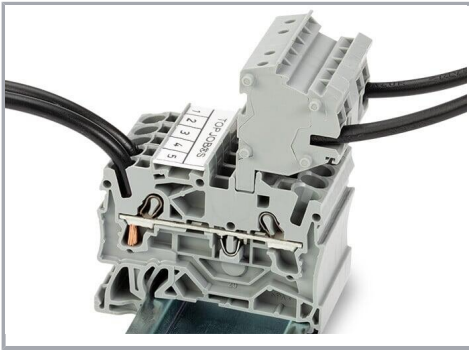

The modular TOPJOB® S connectors also connect conductors of the same size as the terminal blocks being used.



TOPJOB® S Connectors with a 2 mm Ø test socket for testing voltage via 2-pole voltage tester

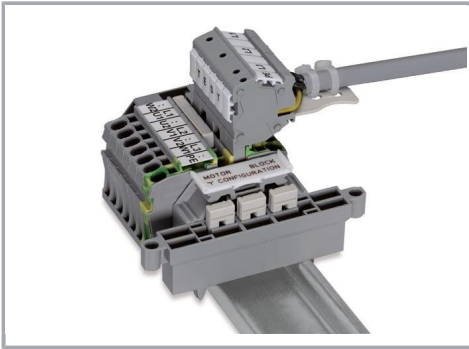

Rail-mount terminal block assembly for electric motor wiring



Test plug adapter (2009-174, CAT I) for 4 mm Ø plugs – compatible with 2000 to 2016 Series

Subject to changes. Please also observe the further product documentation!

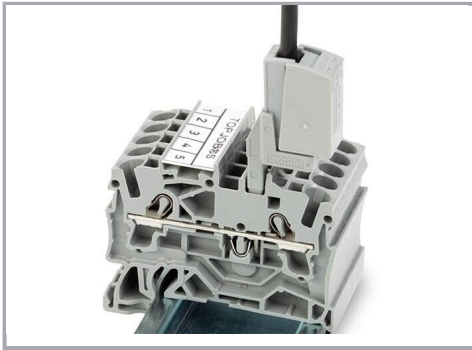

Testing tap (2009-182) for tool-free connection of test cables up to 2.5 mm² (12 AWG) – compatible with 2000 to 2016 Series

Marking

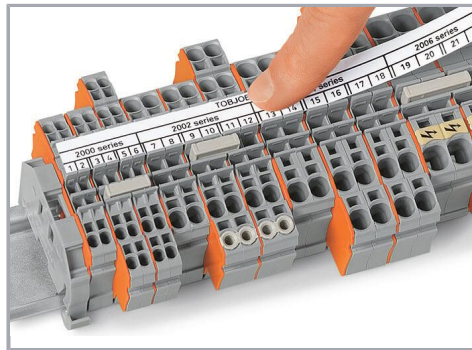
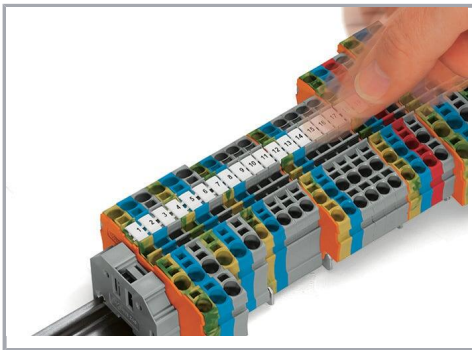

Snapping WMB Inline markers into marker slots.

Subject to changes. Please also observe the further product documentation!

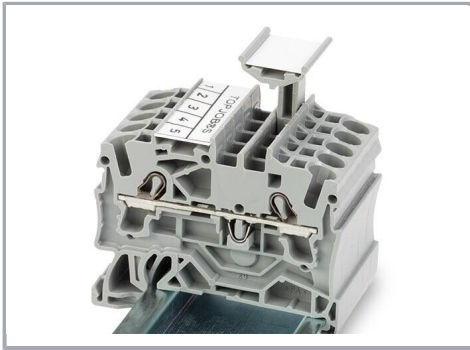

TOPJOB® S 2009-193 Group Marker Carrier (equipped with a marking strip) for all 2001 to 2016 Series TOPJOB® S Rail-Mount Terminal Blocks

Do not use on an end plate!

Product family

TOPJOB® S

TOPJOB® S: In various industrial applications and modern building installations, WAGO's wide and versatile range of rail-mount terminal blocks provides more than just reliable electrical connections.

[Show all products from the family](#)

Subject to changes. Please also observe the further product documentation!