

## 3A, 600V Ultra Fast Surface Mount Rectifier

### FEATURES

- Planar technology
- Low power loss, high efficiency
- Ideal for automated placement
- Moisture sensitivity level: level 1, per J-STD-020
- RoHS Compliant
- Halogen-free according to IEC 61249-2-21

### APPLICATIONS

- DC to DC converter
- Switching mode converters and inverters
- Lighting application
- Snubber
- Freewheeling application

### MECHANICAL DATA

- Case: SOD-128
- Molding compound meets UL 94V-0 flammability rating
- Terminal: Matte tin plated leads, solderable per J-STD-002
- Meet JESD 201 class 2 whisker test
- Polarity: Indicated by cathode band
- Weight: 0.028g (approximately)

KEY PARAMETERS		
PARAMETER	VALUE	UNIT
$I_F$	3	A
$V_{RRM}$	600	V
$I_{FSM}$	45	A
$T_{JMAX}$	150	°C
Package	SOD-128	
Configuration	Single die	



**SOD-128**



ABSOLUTE MAXIMUM RATINGS ( $T_A = 25^\circ\text{C}$ unless otherwise noted)			
PARAMETER	SYMBOL	PU3JFS	UNIT
Marking code on the device		PU3JFS	
Repetitive peak reverse voltage	$V_{RRM}$	600	V
Reverse voltage, total rms value	$V_{R(RMS)}$	420	V
Forward current	$I_F$	3	A
Surge peak forward current single half sine-wave superimposed on rated load	$t = 8.3\text{ms}$	45	A
	$t = 1.0\text{ms}$	100	
Junction temperature	$T_J$	-55 to +150	°C
Storage temperature	$T_{STG}$	-55 to +150	°C

<b>THERMAL PERFORMANCE</b>			
<b>PARAMETER</b>	<b>SYMBOL</b>	<b>TYP</b>	<b>UNIT</b>
Junction-to-lead thermal resistance	$R_{\theta JL}$	15	°C/W
Junction-to-ambient thermal resistance	$R_{\theta JA}$	74	°C/W
Junction-to-case thermal resistance	$R_{\theta JC}$	15	°C/W

**Thermal Performance Note:** Units mounted on PCB (5mm x 5mm Cu pad test board)

<b>ELECTRICAL SPECIFICATIONS</b> ( $T_A = 25^\circ\text{C}$ unless otherwise noted)					
<b>PARAMETER</b>	<b>CONDITIONS</b>	<b>SYMBOL</b>	<b>TYP</b>	<b>MAX</b>	<b>UNIT</b>
Forward voltage <sup>(1)</sup>	$I_F = 1.5\text{A}, T_J = 25^\circ\text{C}$	$V_F$	1.27	-	V
	$I_F = 3.0\text{A}, T_J = 25^\circ\text{C}$		1.43	1.7	V
	$I_F = 1.5\text{A}, T_J = 125^\circ\text{C}$		0.99	-	V
	$I_F = 3.0\text{A}, T_J = 125^\circ\text{C}$		1.16	-	V
Reverse current @ rated $V_R$ <sup>(2)</sup>	$T_J = 25^\circ\text{C}$	$I_R$	-	2	$\mu\text{A}$
	$T_J = 125^\circ\text{C}$		5	-	$\mu\text{A}$
Junction capacitance	1MHz, $V_R = 4.0\text{V}$	$C_J$	31	-	pF
Reverse recovery time	$I_F = 0.5\text{A}, I_R = 1.0\text{A}, I_{rr} = 0.25\text{A}$	$t_{rr}$	-	25	ns
	$I_F = 1.0\text{A}, di/dt = 50\text{A}/\mu\text{s}, V_R = 30\text{V}$		26	-	
Reverse recovery current	$I_F = 3.0\text{A}, di/dt = 200\text{A}/\mu\text{s}, V_R = 400\text{V}$	$I_{RM}$	2.9	-	A
Reverse recovery charge		$Q_{rr}$	62	-	nC
Reverse recovery time		$t_{rr}$	43	-	ns

**Notes:**

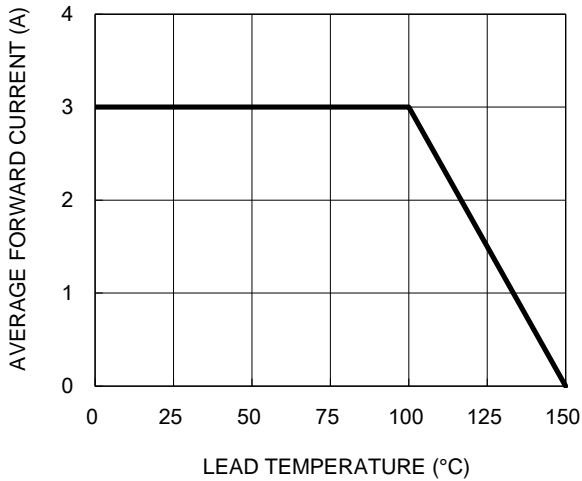
1. Pulse test with PW = 0.3ms
2. Pulse test with PW = 30ms

<b>ORDERING INFORMATION</b>		
<b>ORDERING CODE</b>	<b>PACKAGE</b>	<b>PACKING</b>
PU3JFS	SOD-128	14,000/ Tape & Reel

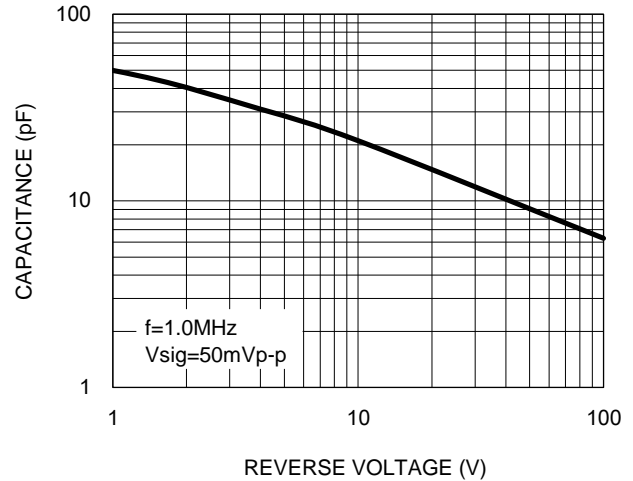
**CHARACTERISTICS CURVES**

( $T_A = 25^\circ\text{C}$  unless otherwise noted)

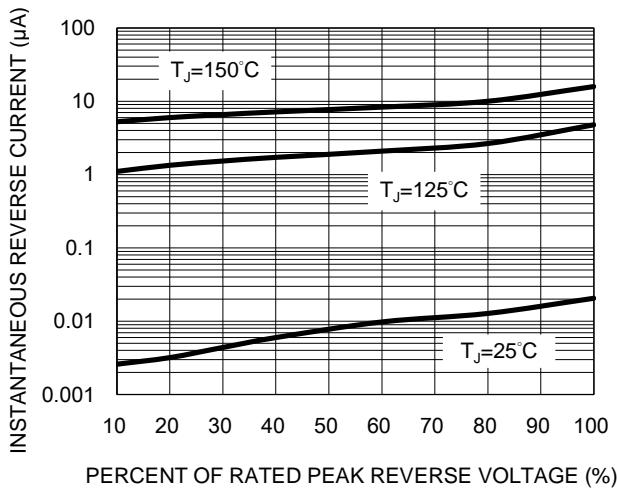
**Fig.1 Forward Current Derating Curve**



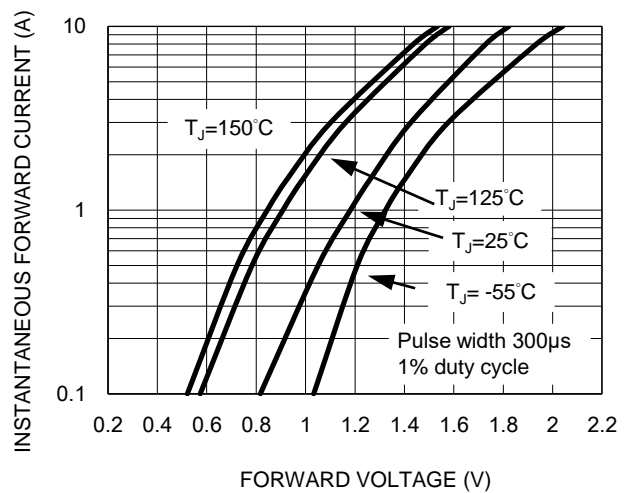
**Fig.2 Typical Junction Capacitance**



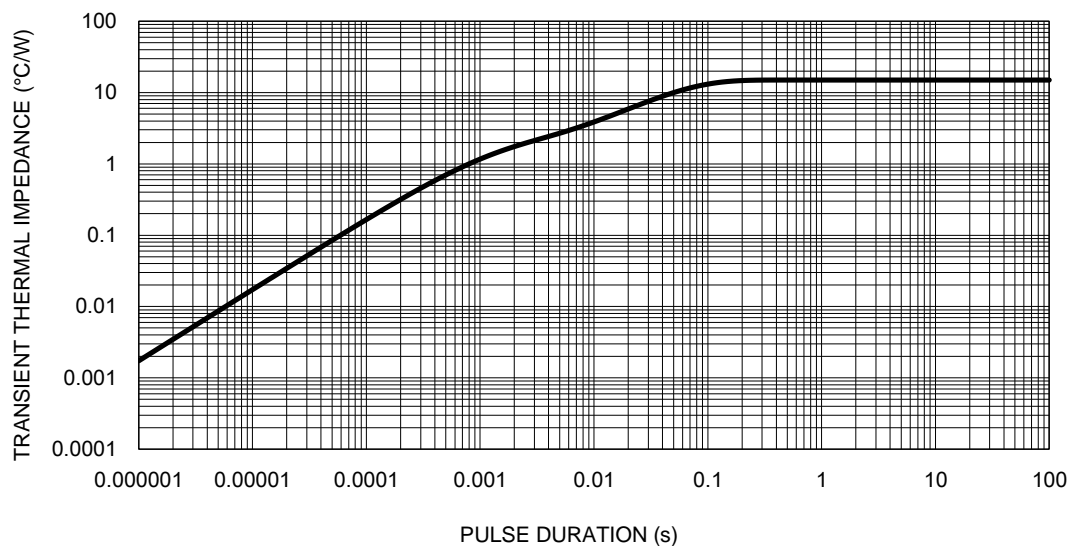
**Fig.3 Typical Reverse Characteristics**



**Fig.4 Typical Forward Characteristics**

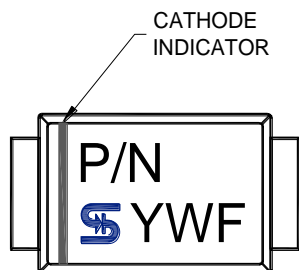
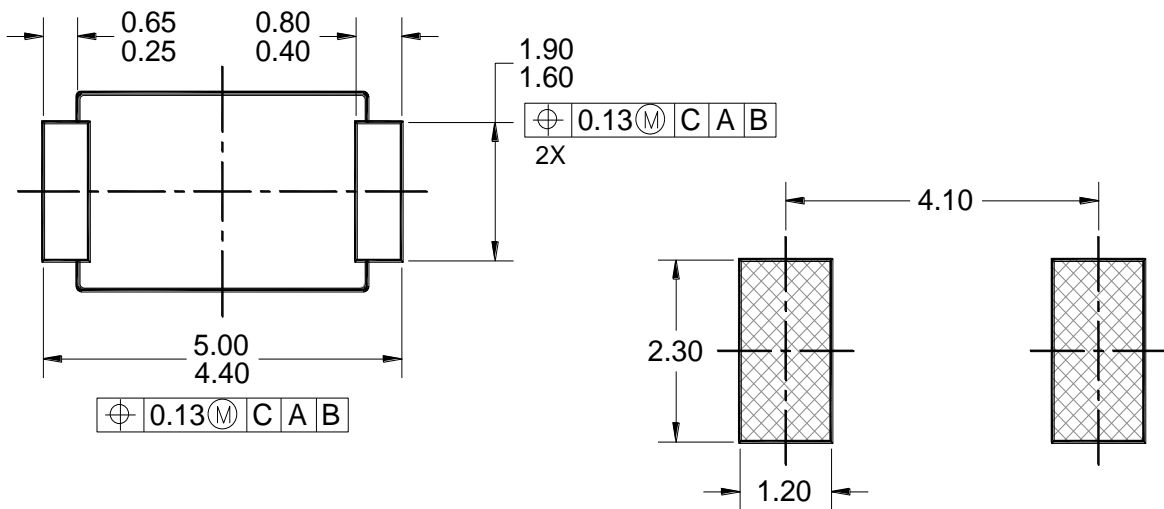
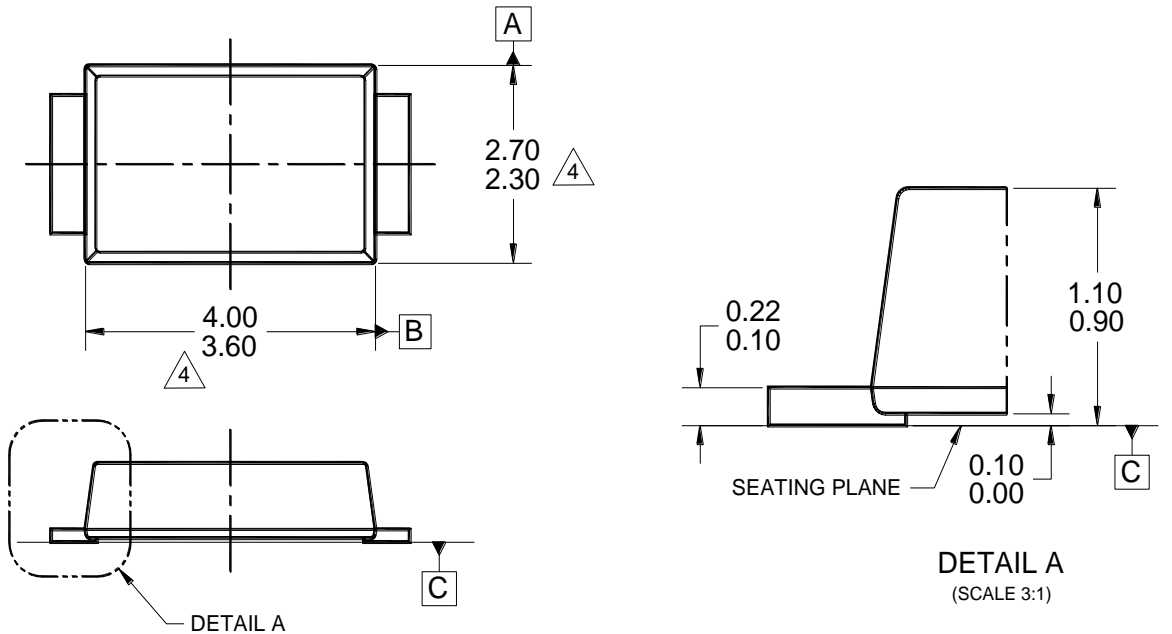


**Fig.5 Typical Transient Thermal Impedance**



**PACKAGE OUTLINE DIMENSIONS**

**SOD-128**



**MARKING DIAGRAM**

P/N = MARKING CODE  
YW = DATE CODE  
F = FACTORY CODE

**NOTES: UNLESS OTHERWISE SPECIFIED**

- ALL DIMENSIONS ARE IN MILLIMETERS.
- DIMENSIONING AND TOLERANCING PER ASME Y14.5M-2009.
- PACKAGE OUTLINE REFERENCE: JEDEC DO-221, VARIATION AD, ISSUE B.
- MODED PLASTIC BODY DIMENSIONS DO NOT INCLUDE MOLD FLASH.
- DWG NO. REF: HQ2SD07-SOD128-039 REV A.

## Notice

Specifications of the products displayed herein are subject to change without notice. TSC or anyone on its behalf, assumes no responsibility or liability for any errors or inaccuracies.

Purchasers are solely responsible for the choice, selection, and use of TSC products and TSC assumes no liability for application assistance or the design of Purchasers' products.

Information contained herein is intended to provide a product description only. No license, express or implied, to any intellectual property rights is granted by this document. Except as provided in TSC's terms and conditions of sale for such products, TSC assumes no liability whatsoever, and disclaims any express or implied warranty, relating to sale and/or use of TSC products including liability or warranties relating to fitness for a particular purpose, merchantability, or infringement of any patent, copyright, or other intellectual property right.

The products shown herein are not designed for use in medical, life-saving, or life-sustaining applications. Customers using or selling these products for use in such applications do so at their own risk and agree to fully indemnify TSC for any damages resulting from such improper use or sale.