

Click [here](#) to ask about the production status of specific part numbers.

MAX22005 Evaluation Kit

Evaluates: MAX22005

General Description

The MAX22005 evaluation kit (EV kit) provides a proven design to evaluate the MAX22005, 12-Channel factory-calibrated configurable industrial-analog input. The MAX22005 EV kit includes the MAX22005 evaluation board and a graphical user interface (GUI) that provides communication from a PC to the target device through a USB port.

The GUI is compatible with Windows® 10 for exercising the features of the MAX22005 IC. The EV kit GUI allows the user to read the 24-bit ADC conversion result for any of the input channels through the high-speed SPI interface in single-ended, differential, or multifunctional configurations. The SPI interface is galvanically isolated from the USB port.

The MAX22005 EV kit must be powered from an external +24V power supply through the power jack (J100). The on-board DC-DC converters provide $\pm 15V$ HVDD/HVSS and +3.3V AVDD/DVDD power rails for the entire board.

The MAX22005 EV kit board comes with a MAX22005ALM+ installed in a 48-pin, 7.5mm x 7.0mm LGA package.

Ordering Information appears at end of data sheet.

Features

- Easy Selection and Configuration of Input Channels
- On-the-Fly Configuration as Analog Input-Voltage Mode or Analog Input-Current Mode
 - $\pm 12.5V$ and 0V to +12.5V Ranges in Analog Input-Voltage Mode
 - $\pm 25mA$ and 0V to 25mA Ranges in Analog Input-Current Mode
- MAX22005 is Factory Calibrated
 - EV Kit Does Not Require System Calibration for AIVM
- CRC Detection for Robust Communication
- Watchdog Timer for SPI Activity
- Access to Eight GPIO Channels
- Ability to Synchronize Multiple EV kits for Simultaneous ADC Conversion
- $-40^{\circ}C$ to $+125^{\circ}C$ Temperature Range
- Proven PCB Layout
- Fully Assembled and Tested
- Windows 10 Compatible Software

MAX22005 EV Kit

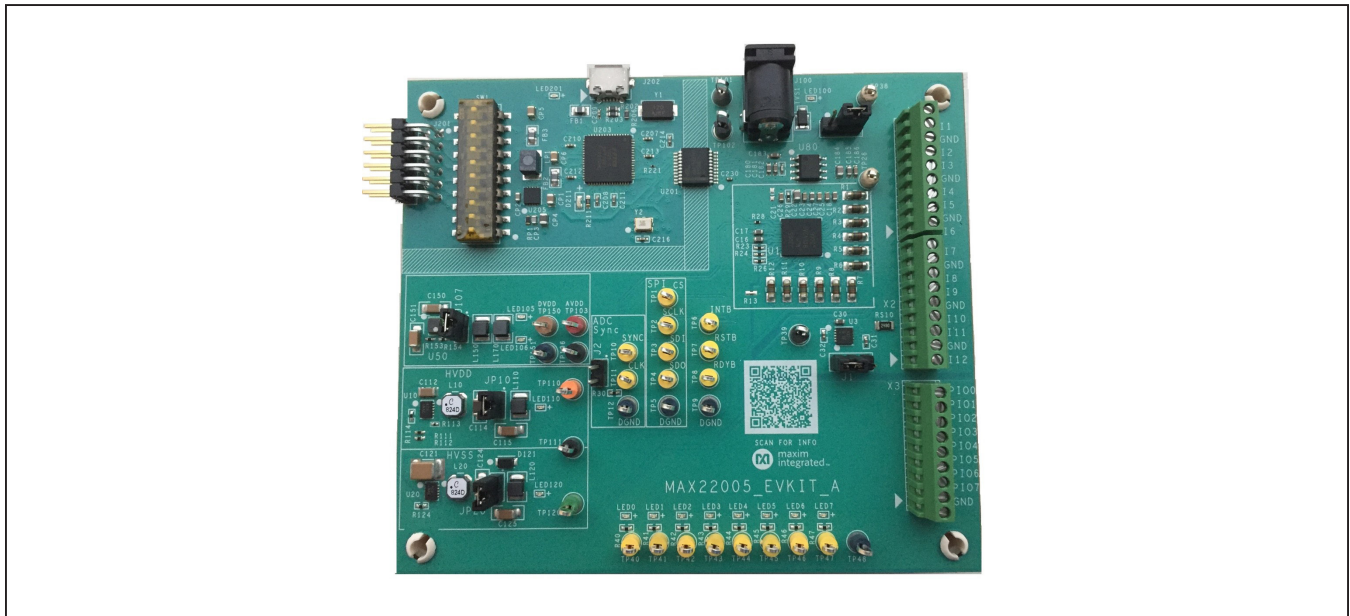

Windows is a registered trademark of Microsoft Corporation.



MAX22005 EV Kit Block Diagram

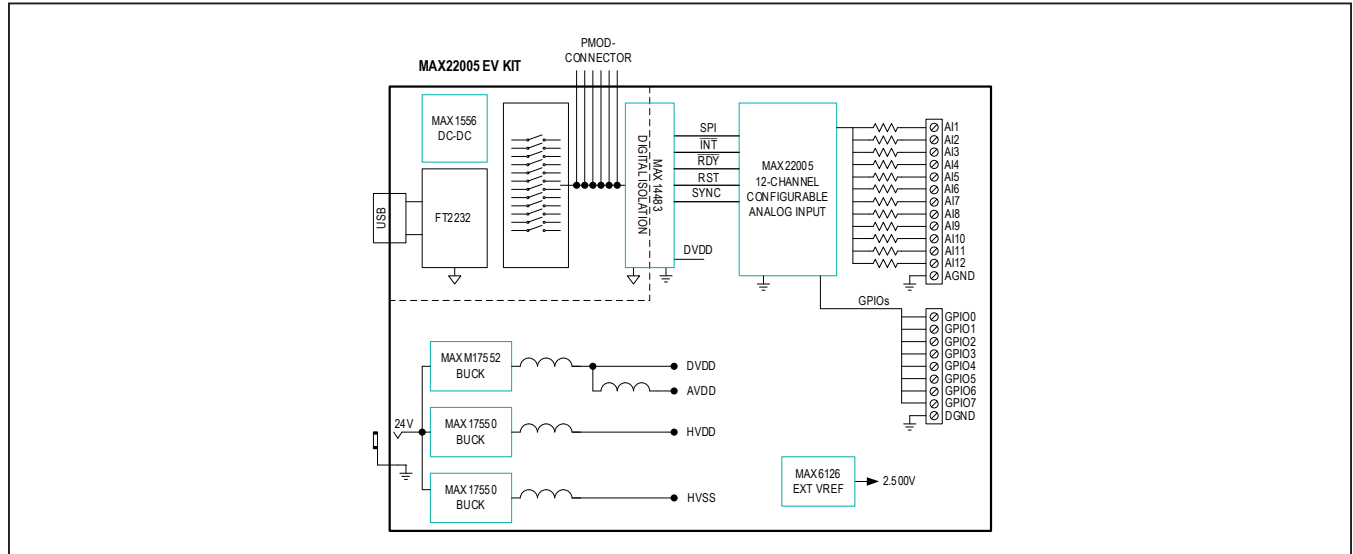

MAX22005 EV Kit Files

FILE	DESCRIPTION
MAX22005EVKITSetupV1.0.exe	Application Program (GUI)

Quick Start

Required Equipment

- MAX22005EVKIT#
- +24V DC power supply
- PC with installed Windows 10 and a USB port
- USB-A to micro-USB cable

Note: In the following section(s), software-related items are identified by bolding. Text in **bold** refers to items directly from the EV system software. Text in **bold and underline** refers to items from the Windows operating system.

Procedure

The EV kit is fully assembled and tested. Follow the steps below to verify board operation:

- 1) Visit <https://www.maximintegrated.com/en/design/tools/applications/evkit-software/index.mvp> to download the latest version of the EV kit software, MAX22005EVKITSetupV1.0.exe or latest.
- 2) Install the EV kit software and USB driver on your computer by running the MAX22005EVKITSetupV1.0.exe program inside the temporary folder. The program files are copied to your PC and icons are created in the

- Windows **Start | Programs** menu. During software installation, some version of Windows might show a warning message indicating that the software is from unknown publisher. This is not an error condition and it is safe to proceed with installation. Administrator privileges require to install the USB device driver.
- 3) Verify that all jumpers are in their default positions, as shown in [Table 1](#).
- 4) Power up the EV kit with +24V from an external power supply through the J100 power jack or using TP101 (24V) and TP102 (GND) test points. Green LEDs are used to indicate valid power supplies. The 24V supply is indicated by LED100, and DVDD and AVDD supplies are indicated by LED105 and LED 106, respectively. The +15V HVDD and -15V HVSS supplies can be monitored by a multimeter on TP110 and TP120 referenced to TP111 (AGND). Note, the DGND and AGND are shorted together.
- 5) Connect the USB cable from the PC to the EV kit. A Windows message appears when connecting the EV kit board to the PC for the first time. Each version of Windows has a slightly different message. If you see a Windows message starting **ready to use**, then proceed to the next step.

- 6) Start the EV kit software by opening the icon in the **Start | Programs | Maxim Integrated** menu. The EV kit software **Analog Input** tab appears as shown in [Figure 1](#).
- 7) Verify that the lower-right status bar indicates the EV kit hardware is **Connected**.
The GUI automatically detects if the EV kit is connected to the PC and enables serial communication.
- 8) Jump the wire from the X1.9 connector (AI1 input) to the TP26 (REF_ADC) to verify the IC functionality.
- 9) In the **Analog Input** tab select **Single Ended ±12.5V Mode** from the Mode dropdown menu (default), uncheck all other selected channels and hit the **Read All** button. The ADC read value in both volt and hex format appears in the respective AI_ read boxes. The voltage value should be close to 2.5V.
- 10) Select the **Register** tab, shown in [Figure 2](#), and click **Read All** button to read all the registers in the device. Inspect all the registers settings for the previous setup of AI1 single-ended reading.

The following steps are used to verify functionality of the MAX22005.

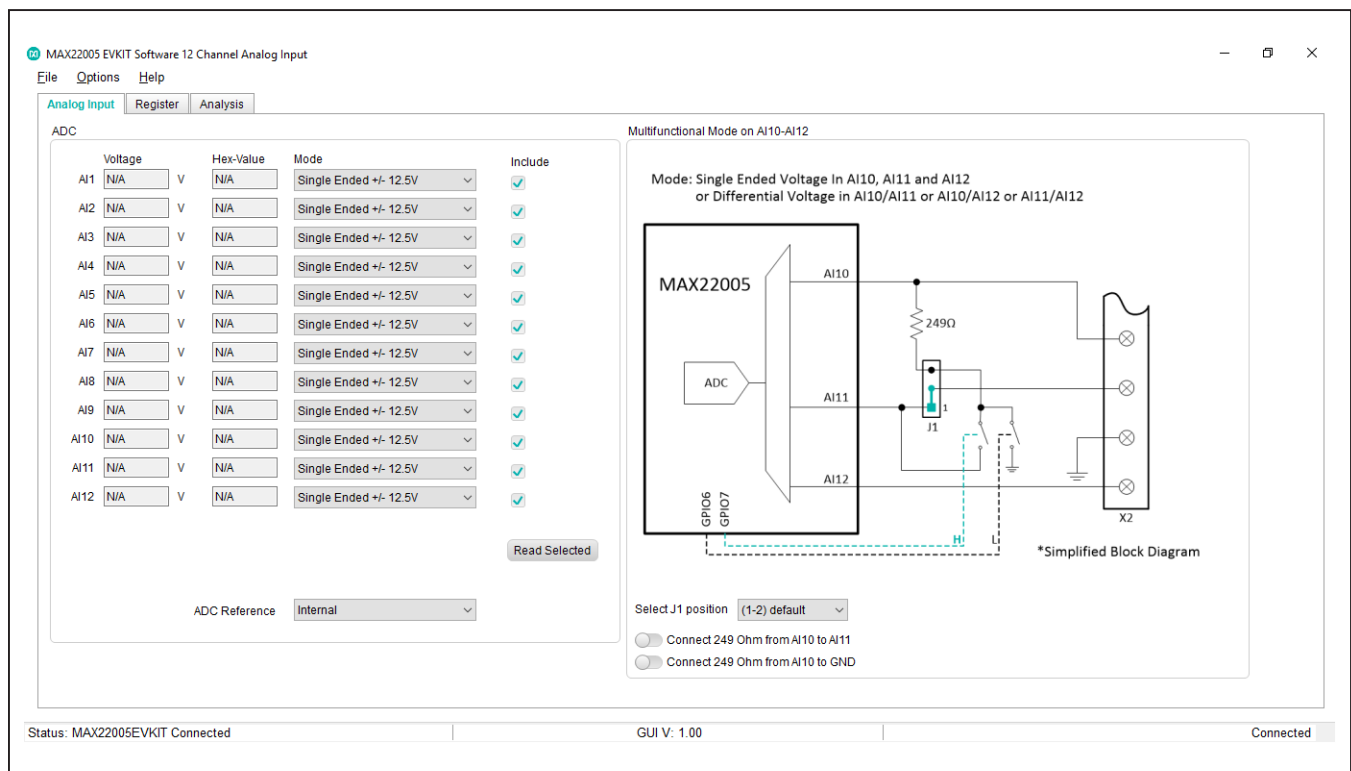

Figure 1. MAX22005 EV Kit GUI Analog Input Tab

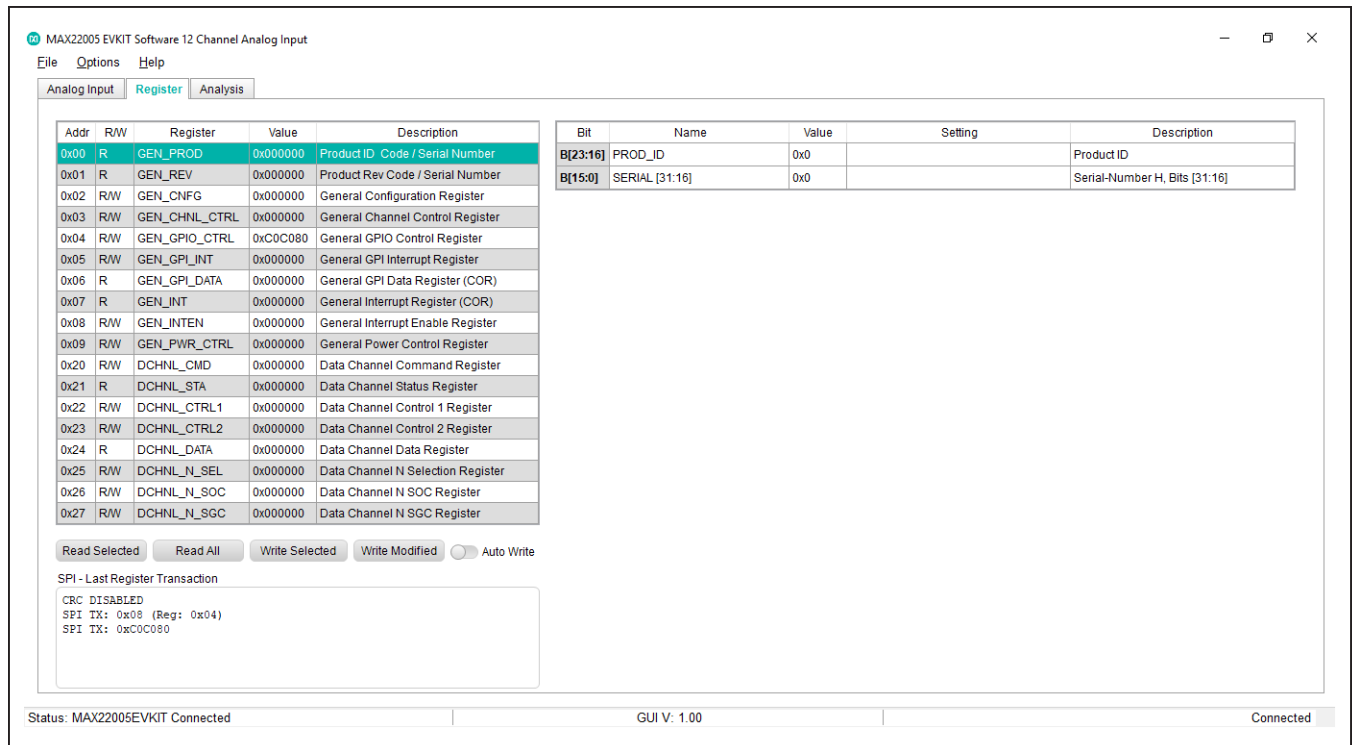

Figure 2. MAX22005 EV Kit GUI Register Tab

Detailed Description of Hardware

The MAX22005EVKIT# provides an easy-to-use and flexible solution for evaluating the MAX22005, 12-channel factory-calibrated configurable analog-input IC for industrial applications. The MAX22005 EV kit communicates to a PC through a commonly available A-to-micro-B USB cable. Since there is no on-board microprocessor, all coordination and low-level SPI transactions are managed by code on the PC, as part of the GUI.

For users who prefer more direct control through their own hardware, important signals are made available through

J201, which offers a 6x2 header with 0.1” spacing that is sometimes called a Pmod™ header, making it compatible with many FPGA and microcontrollers systems (refer to the [MAX22005 EV Kit Schematic](#)). As well as independent dedicated connection, J201 can also be paired with the Maxim’s [USB2GPIO#](#) control card. If J201 is used, disconnect the PC interface from the MAX22005 EV kit by opening all switches on SW1.

For a list of configuration options refer to [Table 1](#).

Pmod is a trademark of Digilent, Inc.

Table 1. MAX22005 Kit Shunt Positions & Settings

HEADER	SHUNT POSITION	DESCRIPTION
J1	1–2*	AI11 input of U1 is connected to the X2 terminal block for single-ended voltage input mode, or differential AI10–AI11, or AI10–AI12 voltage input mode. The analog switch (U3) should be disabled (default state). For AICM mode configuration refer to Table 2.
	2–3	AI11 is disconnected from X2 for multifunctional configuration. U3 and GPIO[7:6] are used for various configuration options, refer to Table 2.
	Open	U3 and GPIO[7:6] are used for various configuration options, refer to Table 2.
J7	1–2*	REF_ADC_EXT supplied from an external 2.5V voltage reference (U80).
	2–3	RED_ADC_EXT is grounded. ADC is using an internal 2.5V voltage reference.
	Open	Off-board 2.5V Voltage Reference can be applied to J7.2.
JP10	1–2*	Fixed +15V to HVDD is supplied from the DC-DC converter (U10).
	Open	Apply +5V to +24V from an external voltage source between TP110 (HVDD) and TP111 (AGND).
JP20	1–2*	Fixed -15V to HVSS is supplied from the DC-DC converter (U20).
	Open	Apply -5V to -24V from an external voltage source between TP120 (HVSS) and TP111 (AGND).
J107	1–2*	Fixed +3.3V to DVDD and AVDD is supplied from the integrated step-down power module (U50).
	Open	Apply +2.7V to +3.6V from an external voltage source between TP150 (DVDD) and TP151 (DGND).

*Default configuration

The Analog Input channels AI1 through AI12 can accept the voltages from the external source(s), such as two-wire voltage sensors, in range of $\pm 12.5V$ for single-ended configuration and $\pm 25V$ for differential configuration. All input channels are tolerant up to $\pm 36V$. The on-board 4.75k Ω input resistors protect the inputs up to $\pm 2kV$ Surge pulses. The input signals should be applied through X1 and X2 screw terminals. The terminals allow either single-ended, differential, or multifunctional inputs. For example, the AI1 single-ended input should be applied between X1.9 (AI1) and X1.8 (AGND), while the AI1–AI2 differential input should be applied between X1.9 (AI1) and X1.7 (AI2) terminals.

All input channels also can be used for measuring input current. In this case, current-to-voltage conversion is performed using the external 249 Ω resistor(s). Usually, analog input-current mode (AICM) is used for measuring a 4mA–20mA loop current. The value and accuracy of the sense resistor is selected to comply with the analog input-voltage mode (AIVM) ranges. For more information refer to the MAX22005 data sheet. All twelve input channels are factory calibrated for AIVM and need to be recalibrated for the AICM to include sense resistor value and accuracy. An example of the AICM is implemented for AI10 (single-ended) and AI10–AI11 (differential) inputs, and RS10 sense resistor and the MAX14761 analog switch (U3). Refer to the multifunctional configuration (Table 2) for details.

An example of a multifunctional configuration is implemented on AI10, AI11 and AI12 input triplet, J1 jumper, RS10, and U3 switch. GPIO6 and GPIO7 are used to control the AI10, AI11, and AI12 configuration for on-the-fly change for either AIVM or AICM mode. When J1 is in the 1–2 position, GPIO6 is high and GPIO7 is low, both U3 analog switches are open, and the AI10–AI11 pair is in AICM differential mode, while the AI10–AI12 pair is in AIVM differential mode. In this case, both the current and voltage information are available for that channels.

All possible combinations of multifunctional configurations of AI10, AI11, and AI12 are shown in Table 2. The J1 shunt position and GPIO[7:6] settings allow for switching between different modes in a multifunctional configuration. The GUI conveniently provides different block diagrams for proper connection to the AI10, AI11, and AI12 inputs for the selected combinations.

For users who wish to perform their own calibration, refer to AN7449 and the MAX22005 data sheet for a two-point user calibration technique.

The current reading for AICM mode is provided in volts as measured by the voltage drop on the sense resistor RS10. The user must divide the reported voltage by 249 to get the current value in amperes.

Table 2. AI10, AI11 and AI12 Multifunctional Configurations

J1 SHUNT	GPIO[6]	GPIO[7]	AI_DCHNL_SEL[4:0]	CONFIGURATION DESCRIPTION
1–2*	Low*	High*	01001	AI10 in AIVM single-ended mode
1–2	High	High	01001	AI10 in AICM single-ended mode
1–2	Low	High	01010	AI11 in AIVM single-ended mode
X	X	X	01011	AI12 in AIVM single-ended mode
1–2	Low	High	10001	AI11–AI12 in AIVM differential mode
1–2	Low	Low	11000	AI10–AI11 in AICM multifunctional differential mode
1–2	High	Low	11000	AI10–AI11 in AICM multifunctional differential mode
1–2	X	X	11001	AI10–AI12 in AIVM multifunctional differential mode
2–3	Low	High	01001	AI10 in AIVM single-ended mode
2–3	Low	High	11001	AI10–AI12 in AIVM multifunctional differential mode
2–3	Low	Low	11000	AI10–AI11 in AICM multifunctional differential mode
2–3	High	High	01001	AI10 in AICM multifunctional single-ended mode
2–3	High	High	11001	AI10–AI12 in AIVM multifunctional differential mode
2–3	High	Low	11000	AI10–AI11 in AICM multifunctional differential mode
2–3	High	Low	11001	AI10–AI12 in AIVM multifunctional differential mode
Open	Low	Low	11000	AI10–AI11 in AICM multifunctional differential mode
Open	High	High	11000	AI10–AI11 in AICM multifunctional single-ended mode
Open	High	Low	11000	AI10–AI11 in AICM multifunctional differential mode

*Default configuration

Detailed Description of Software

The MAX22005 GUI provides full control of the MAX22005. There are three tabs available to operate and control the EV kit. The **Analog Input** tab provides a quick reading of the conversion results of the selected channels. The **Register** tab provides full access to the internal registers including access to configurations, data rate control, interrupts, etc.

The **Analysis** tab allow to see the captured input signal either in **Scope** mode or as **FFT** in frequency domain.

Analog Input Tab

The GUI sets all the channels into single-ended AIVM single-cycle mode with the conversion rate of 1sps by default as shown in [Figure 1](#). The GUI is reading all selected input channels one-by-one when the user presses the **Read All** button.

Register Tab

The **Register** tab allows control of the MAX22005 through the register setting (refer to [Figure 2](#)). The detailed description of each bit of the selected register is shown on the right table, as shown in [Figure 3](#). The register setting can be changed directly in the register map table by

double clicking on the **Value** cell or from the pull-down menu in the **Setting** cell on the right table. Each data entry should follow by the “Enter/Return” button on the keyboard. The **Value** cell accepts binary (0b), decimal or hex (0x) numbers. The modified register changes its color from black to red until the data is written to the register. The data in the right table can be changed using the drop-down menus in the **Setting** cell for each bit individually. Both tables are synchronized so that changes made in one table appear in both tables. There are several write and read options available through the corresponding control buttons located below the register bit-by-bit description table.

When the **Auto Write** switch is in the ON position, any data typed in, or selected through the **Setting** pull-down menu is automatically written into the corresponding writable register.

The **Write Selected** button allows to write to the selected (highlighted) register only.

The cyclic redundancy check (CRC) is automatically supported by the GUI when the **CRC_EN** bit is set in the **GEN_CONFIG** register **0x02**. The **CRC Calculator** is provided for user convenience under the **Help** menu.

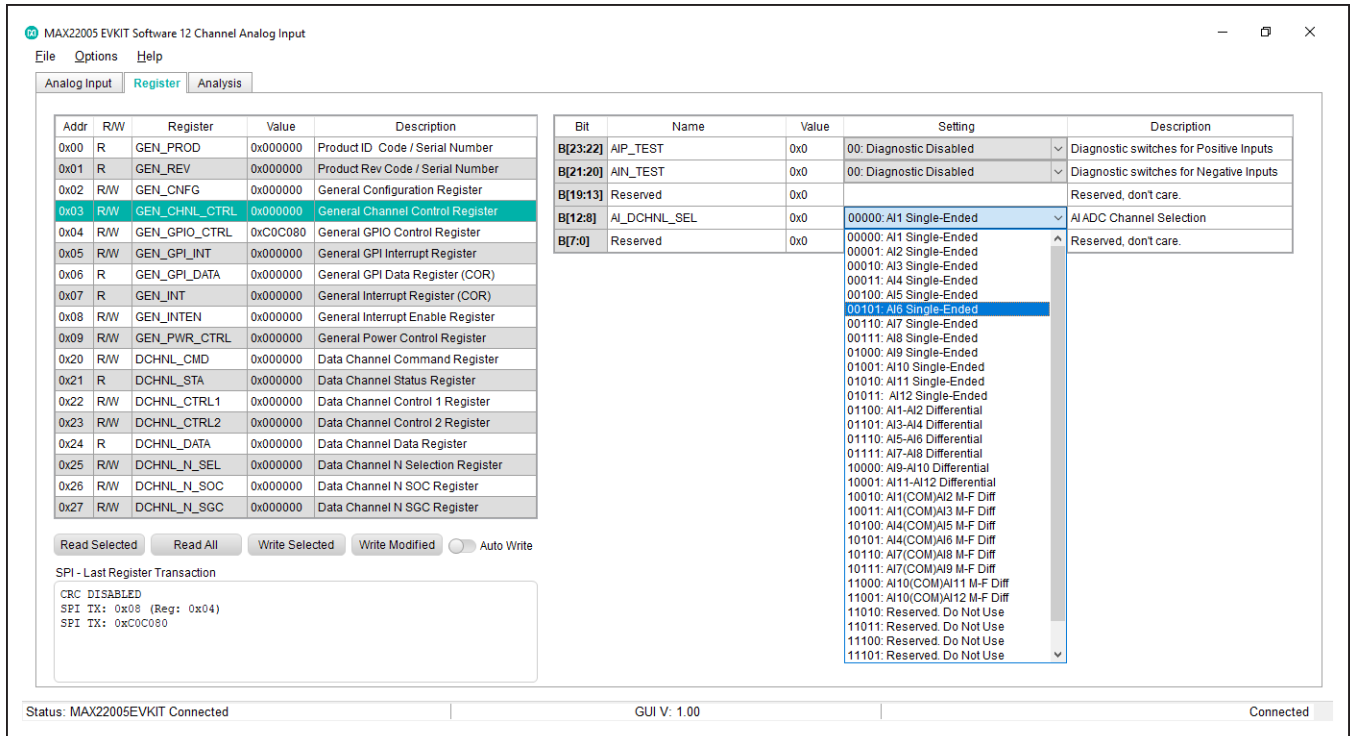

Figure 3. MAX22005 EV Kit GUI, Register Tab Settling

The SPI transmitted, TX, and received, RX, data is reflected in the **Register** tab lower left corner as shown in [Figure 4](#), [Figure 5](#), and [Figure 6](#).

[Figure 4](#) shows the data read from register 0x00, 0x18B0BA while CRC is disabled.

[Figure 5](#) shows the data read from register 0x00 while CRC is enabled. The CRC byte is 0xAE (received) and confirmed by the host.

[Figure 5](#) also shows the SPI data sent by the host to the MAX22005 with the CRC byte 0xCD.

The command (select an AI2 input channel in register 0x03) is executed if the CRC byte is matched with the CRC calculated by the MAX22005.



Figure 4. SPI Read Transaction with CRC Disabled

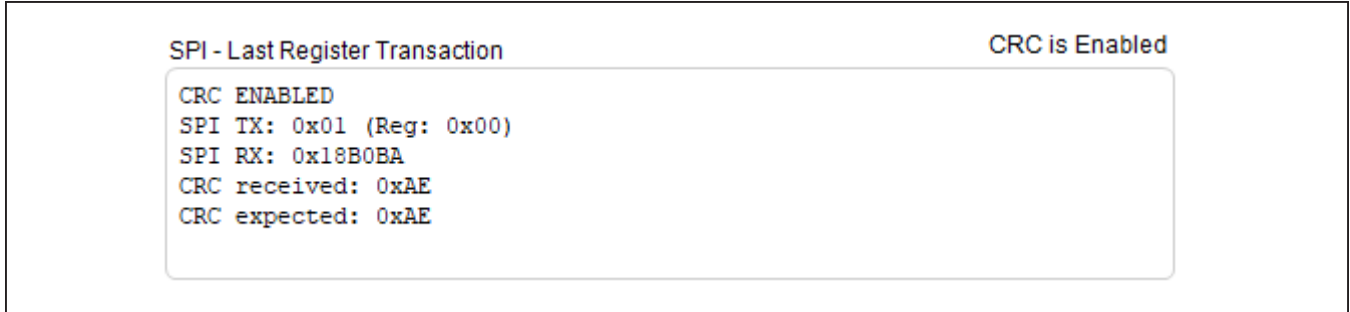

Figure 5. SPI Read Transaction with CRC Enabled



Figure 6. SPI Write Transaction with CRC Enabled

Analysis Tab

The **Analysis** tab shown in [Figure 7](#) permits capture and visual display of any analog input channels as an oscilloscope format in the time domain, or as a FFT format in the frequency domain. In **Scope** mode, the x-axis is either seconds per division, or a count of the number of

samples, while the y-axis is in voltage or LSB format. In **FFT** mode, the x-axis is frequency (Hz) and y-axis is dB. The input channel, sampling rate, and number of samples are selected from the respective pulldown menus. Captured data can be saved to an 'Analog Datapoint file' in .csv format.

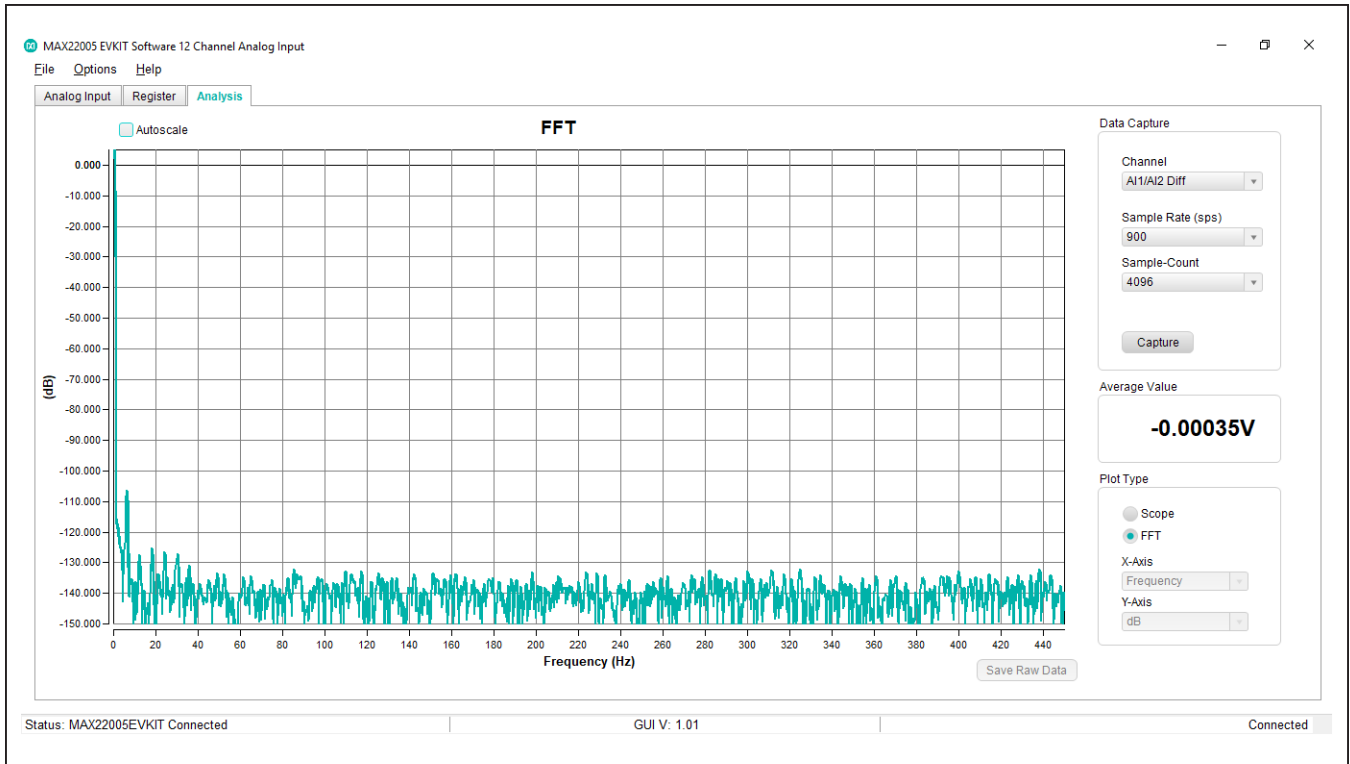

Figure 7. MAX22005 EV Kit GUI, Analysis Tab

Ordering Information

PART	TYPE
MAX22005EVKIT#	EV Kit

#Denotes RoHS compliance.

MAX22005 EV Kit Bill of Materials

ITEM	REF_DES	DNI/DNP	QTY	MFG PART #	MANUFACTURER	VALUE	DESCRIPTION
1	C1-C12	-	12	GRM155R71H332KA01	MURATA	3300PF	CAP; SMT (0402); 3300PF; 10%; 50V; X7R; CERAMIC
2	C15-C18, C30, C180, C185	-	7	GRM188R70J105KA01; CL10B105KQ8NNNC	MURATA;SAMSUNG ELECTRONICS	1.0UF	CAP; SMT (0603); 1.0UF; 10%; 6.3V; X7R; CERAMIC;
3	C19, C28, C112, C122, C150	-	5	C1206C105K5RAC; GRM31CR71H105KA61; GRM31MR71H105KA88; GCM31MR71H105KA55; CGA5L3X7R1H105K160AB; C3216X7R1H105K160AE	KEMET;MURATA;MURATA; MURATA;TDK;TDK	1UF	CAP; SMT (1206); 1UF; 10%; 50V; X7R; CERAMIC
4	C22, C184	-	2	GRM21BR71A475KA73; LMK212B7475KG-T; C2012X7R1A475K125AC	MURATA;TAIYO YUDEN;TDK	4.7UF	CAP; SMT (0805); 4.7UF; 10%; 10V; X7R; CERAMIC
5	C23, C25, C181, C183, C186	-	5	C0603C104K9RAC; GRM188R70J104KA01	KEMET;MURATA	0.1UF	CAP; SMT (0603); 0.1UF; 10%; 6.3V; X7R; CERAMIC;
6	C24	-	1	C0603C105K4RAC; GRM188R71C105KA12; C1608X7R1C105K080AC; EMK107B7105KA; CGA3E1X7R1C105K080AC; 0603YC105KAT2A	KEMET;MURATA;TDK; TAIYO YUDEN;TDK;AVX	1UF	CAP; SMT (0603); 1UF; 10%; 16V; X7R; CERAMIC
7	C26	-	1	C0603C224K3RAC; GMC10X7R224K25; GRM188R71E224KA88; C1608X7R1E224K080AC	KEMET;MURATA;MURATA;TDK	0.22UF	CAP; SMT (0603); 0.22UF; 10%; 25V; X7R; CERAMIC
8	C27	-	1	GRM188R71C103KA01; ECJ-1V81C10; CL10B103K08NNN; GCJ188R71C103KA01	MURATA;PANASONIC; SAMSUNG;MURATA	0.01UF	CAP; SMT (0603); 0.01UF; 10%; 16V; X7R; CERAMIC
9	C31, C32	-	2	C1005X7R1H104K050BB; GRM155R71H104KE14; C1005X7R1H104K050BE; UMK105B7104KV-FR	TDK;MURATA;TDK; TAIYO YUDEN	0.1UF	CAP; SMT (0402); 0.1UF; 10%; 50V; X7R; CERAMIC
10	C111, C115, C125	-	3	C3216X5R1H106K160AB; GRM31CR61H106KA12	TDK;MURATA	10UF	CAP; SMT (1206); 10UF; 10%; 50V; X5R; CERAMIC
11	C114, C124	-	2	GRM31CR71H475KA12; GRJ31CR71H475KE11; GXM31CR71H475KA10; UMK316AB7475KL	MURATA;MURATA; MURATA;TAIYO YUDEN	4.7UF	CAP; SMT (1206); 4.7UF; 10%; 50V; X7R; CERAMIC
12	C121	-	1	C4532X7R2A105M230KA	TDK	1UF	CAP; SMT (1812); 1UF; 20%; 100V; X7R; CERAMIC
13	C151	-	1	GRM31CR71E106KA12; CL31B106KAHNNN	MURATA;SAMSUNG ELECTRONICS	10UF	CAP; SMT (1206); 10UF; 10%; 25V; X7R; CERAMIC
14	C171, C173, CP4	-	3	C2012X7S1A226M125AC	TDK	22UF	CAP; SMT (0805); 22UF; 20%; 10V; X7S; CERAMIC
15	C172	-	1	GRM1555C1H102JA01; C1005C0G1H102J050	MURATA;TDK	1000PF	CAP; SMT (0402); 1000PF; 5%; 50V; C0G; CERAMIC
16	C182	-	1	C0402C470K5GAC	KEMET	47PF	CAP; SMT (0402); 47PF; 10%; 50V; C0G; CERAMIC
17	C201	-	1	C1005X7R1V103K050BB	TDK	0.01UF	CAP; SMT (0402); 0.01UF; 10%; 35V; X7R; CERAMIC
18	C202, C203	-	2	C0402C180J5GAC; GRM1555C1H180JA01; C1005C0G1H180J050BA	KEMET;MURATA;TDK	18PF	CAP; SMT (0402); 18PF; 5%; 50V; C0G; CERAMIC
19	C204	-	1	C0603C475K8PAC; LMK107BJ475KA; CGB3B1X5R1A475K; C1608X5R1A475K080AC; CL10A475KP8NNN; C1608X5R1A475K080AE	KEMET;TAIYO YUDEN;TDK; TDK;SAMSUNG ELECTRONICS;TDK	4.7UF	CAP; SMT (0603); 4.7UF; 10%; 10V; X5R; CERAMIC
20	C205-C216, C230, C231	-	14	C0402C104J4RAC; GCM155R71C104JA55	KEMET;MURATA	0.1UF	CAP; SMT (0402); 0.1UF; 5%; 16V; X7R; CERAMIC
21	CP1	-	1	CL21A106K0QNNN; GRM21BR61C106KE15; EMK212ABJ106KD	SAMSUNG ELECTRONICS; MURATA;TAIYO YUDEN	10UF	CAP; SMT (0805); 10UF; 10%; 16V; X5R; CERAMIC
22	CP2	-	1	UMK107BJ105KA; C1608X5R1H105K080AB; CL10A105KB8NNN; GRM188R61H105KAAL	TAIYO YUDEN;TDK; SAMSUNG;MURATA	1UF	CAP; SMT (0603); 1UF; 10%; 50V; X5R; CERAMIC
23	CP3	-	1	GRM1885C1H102JA01; C1608C0G1H102J080AA; GCM1885C1H102JA16	MURATA;TDK;MURATA	1000PF	CAP; SMT (0603); 1000PF; 5%; 50V; C0G; CERAMIC
24	CP5, CP6	-	2	0805YC475KAT2A; GCM21BR71C475KA73; CGA4J3X7R1C475K125AE; GRM21BR71C475KE51	AVX;MURATA;TDK;MURATA	4.7UF	CAP; SMT (0805); 4.7UF; 10%; 16V; X7R; CERAMIC

MAX22005 EV Kit Bill of Materials (continued)

ITEM	REF_DES	DN/DNP	QTY	MFG PART #	MANUFACTURER	VALUE	DESCRIPTION
25	D121	-	1	DFLS1150	DIODES INCORPORATED	DFLS1150	DIODE; RECT; SMT (POWERDI-123); PIV=150V; IF=1A
26	D211	-	1	LG L29K-G2J1-24	OSRAM	LG L29K-G2J1-24	DIODE; LED; SMT (0603); VF=1.7V; If(test)=0.002A; -40 DEGC TO +100 DEGC
27	FB1	-	1	BLM21AG601SN1	MURATA	600	INDUCTOR; SMT (0805); FERRITE-BEAD; 600; TOL=+/-25%; 0.2A
28	FB2, FB3	-	2	BLM21PG331SN1	MURATA	330	INDUCTOR; SMT (0805); FERRITE-BEAD; 330; TOL=+/-25%; 1.5A
29	J1, J7	-	2	929647-09-03-I	3M	929647-09-03-I	CONNECTOR; MALE; THROUGH HOLE; 929 SERIES; STRAIGHT; 3PINS
30	J2, J107, JP10, JP20	-	4	PEC02SAAN	SULLINS	PEC02SAAN	CONNECTOR; MALE; THROUGH HOLE; BREAKAWAY; STRAIGHT; 2PINS
31	J100	-	1	PJ-202AH	CUI INC.	PJ-202AH	CONNECTOR; MALE; THROUGH HOLE; DC POWER JACK; RIGHT ANGLE; 3PINS
32	J201	-	1	TSW-106-08-S-D-RA	SAMTEC	TSW-106-08-S-D-RA	CONNECTOR; THROUGH HOLE; POST TERMINAL STRIP ASSEMBLY; RIGHT ANGLE; 12PINS;
33	J202	-	1	ZX62RD-AB-5P8(30)	HIROSE ELECTRIC CO LTD.	ZX62RD-AB-5P8(30)	CONNECTOR; MALE; THROUGH HOLE; MICRO-USB CONNECTOR MEETING REQUIREMENTS OF USB 2.0 STANDARD; RIGHT ANGLE; 5PINS
34	L10, L20	-	2	LPS4018-824MR	COILCRAFT	820UH	INDUCTOR; SMT; FERRITE; 820UH; 20%; 0.14A
35	L110, L120, L150, L170	-	4	LQH32CN220K23	MURATA	22UH	INDUCTOR; 1210; 22UH; +/-10%; 0.25A; -40DEGC TO +85DEGC
36	LED0-LED7, LED100, LED105, LED106, LED110, LED120, LED201	-	14	SML-P12PT	ROHM	SML-P12PT	DIODE; LED; SML-P1 SERIES; ULTRA COMPACT HIGH BRIGHTNESS LED; GREEN; SMT (0402); VF=2.2V; IF=0.02A
37	LP1	-	1	B82432T1332K000	TDK	3.3UH	INDUCTOR; SMT (1812); FERRITE CORE; 3.3UH; TOL=+/-10%; 0.9A
38	R1-R12	-	12	MMA02040C4751F	VISHAY BEYSCHLAG	4.75K	RES; SMT; 4.75K; 1%; +/-50PPM/DEGK; 0.4W
39	R21-R24	-	4	ERJ-2RKF10R0	PANASONIC	10	RESISTOR; 0402; 10 OHM; 1%; 100PPM; 0.10W; THICK FILM
40	R26, R28-R30	-	4	ERJ-2RKF1000	PANASONIC	100	RESISTOR; 0402; 100 OHM; 1%; 100PPM; 0.10W; THICK FILM
41	R27, R207	-	2	CRCW040210K0FK; RC0402FR-0710KL	VISHAY DALE; YAGEO PHICOMP	10K	RESISTOR; 0402; 10K; 1%; 100PPM; 0.0625W; THICK FILM
42	R31, R32, R102	-	3	CRCW040222K0FK	VISHAY DALE	22K	RESISTOR, 0402, 22K OHM, 1%, 100PPM, 0.0625W, THICK FILM
43	R40-R47, R175, R176, R201	-	11	ERJ-2RKF1301	PANASONIC	1.3K	RESISTOR; 0402; 1.3K OHM; 1%; 100PPM; 0.10W; THICK FILM
44	R110, R120	-	2	ERJ-2RKF1622	PANASONIC	16.2K	RES; SMT (0402); 16.2K; 1%; +/-100PPM/DEGC; 0.1W
45	R111, R121	-	2	CRCW0402442KFK	VISHAY DALE	442K	RESISTOR; 0402; 442K OHM; 1%; 100PPM; 0.063W; THICK FILM
46	R112, R122	-	2	ERJ-2RKF2492	PANASONIC	24.9K	RESISTOR; 0402; 24.9K OHM; 1%; 100PPM; 0.10W; THICK FILM
47	R113, R123	-	2	RC0201JR-070RL	YAGEO	0	RESISTOR; 0201; 0 OHM; 0%; JUMPER; 0.05W; THICK FILM
48	R114, R124	-	2	ERJ-2RKF6982	PANASONIC	69.8K	RESISTOR; 0402; 69.8K OHM; 1%; 100PPM; 0.10W; THICK FILM
49	R150	-	1	CRCW0402130KFK	VISHAY DALE	130K	RESISTOR; 0402; 130K OHM; 1%; 100PPM; 0.063W; THICK FILM
50	R153	-	1	ERJ-2RKF1583	PANASONIC	158K	RESISTOR; 0402; 158K OHM; 1%; 100PPM; 0.10W; THICK FILM
51	R154	-	1	ERJ-2RKF4992	PANASONIC	49.9K	RESISTOR; 0402; 49.9K OHM; 1%; 100PPM; 0.10W; THICK FILM
52	R202, R203	-	2	CRCW060310R0FK; MCR03EZPFX10R0; ERJ-3EKF10R0	VISHAY DALE; ROHM	10	RESISTOR; 0603; 10 OHM; 1%; 100PPM; 0.10W; THICK FILM
53	R204	-	1	CRCW060310K0FK; ERJ-3EKF1002; AC0603FR-0710KL; RMC0603FT10K0	VISHAY DALE; PANASONIC; YAGEO	10K	RESISTOR; 0603; 10K; 1%; 100PPM; 0.10W; THICK FILM
54	R205	-	1	CRCW060315K0FK	VISHAY DALE	15K	RESISTOR, 0603, 15K OHM, 1%, 100PPM, 0.10W, THICK FILM
55	R206	-	1	CRCW060312K0FK	VISHAY DALE	12K	RESISTOR, 0603, 12K OHM, 1%, 100PPM, 0.10W, THICK FILM
56	R208	-	1	CRCW04022K20FK; RC0402FR-072KZL	VISHAY DALE; YAGEO PHICOMP	2.2K	RESISTOR, 0402, 2.2K OHM, 1%, 100PPM, 0.0625W, THICK FILM
57	R211	-	1	CRCW0603665RFK	VISHAY DALE	665	RESISTOR; 0603; 665 OHM; 1%; 100PPM; 0.10W; THICK FILM
58	R214, R215, R220-R222, R230	-	6	CRCW020110K0FK	VISHAY DALE	10K	RESISTOR; 0201; 10K OHM; 1%; 100PPM; 0.05W; THICK FILM
59	R232	-	1	CRCW0402100KFK; RC0402FR-07100KL	VISHAY; YAGEO	100K	RESISTOR; 0402; 100K; 1%; 100PPM; 0.0625W; THICK FILM
60	RP1	-	1	CRCW0603100RFK; ERJ-3EKF1000; RC0603FR-07100RL	VISHAY DALE; PANASONIC	100	RESISTOR; 0603; 100 OHM; 1%; 100PPM; 0.10W; THICK FILM

MAX22005 EV Kit Bill of Materials (continued)

ITEM	REF_DES	DNI/DNP	QTY	MFG PART #	MANUFACTURER	VALUE	DESCRIPTION
61	RS10	-	1	RP73D2B249RB	TE CONNECTIVITY	249	RES; SMT (1206); 249; 0.1%; +/-15PPM/DEGC; 0.25W
62	SPACER1-SPACER4	-	4	9032	KEYSTONE	9032	MACHINE FABRICATED; ROUND-THRU HOLE SPACER; NO THREAD; M3.5; 5/8IN; NYLON
63	SU1-SU5	-	5	S1100-B;SX1100-B;STC02SYAN	KYCON;KYCON;SULLINS ELECTRONICS CORP.	SX1100-B	TEST POINT; JUMPER; STR; TOTAL LENGTH=0.24IN; BLACK; INSULATION=PBT;PHOSPHOR BRONZE CONTACT=GOLD PLATED
64	SW1	-	1	219-10MST	CTS	219-10MST	SWITCH; SPST; SMT; STRAIGHT; 20V; 0.1A; SURFACE MOUNT DIP SWITCH-AUTO PLACEABLE; RINSULATION=1000M OHM
65	TP1-TP4, TP6-TP8, TP10, TP11, TP40-TP47	-	17	5009	KEYSTONE	N/A	TEST POINT; PIN DIA=0.125IN; TOTAL LENGTH=0.35IN; BOARD HOLE=0.063IN; YELLOW; PHOSPHOR BRONZE WIRE SILVER PLATE FINISH;
66	TP5, TP9, TP12, TP48, TP151	-	5	5127	KEYSTONE	N/A	TEST POINT; PIN DIA=0.125IN; TOTAL LENGTH=0.445IN; BOARD HOLE=0.063IN; BLUE; PHOSPHOR BRONZE WIRE SILVER PLATE FINISH;
67	TP26, TP38	-	2	5007	KEYSTONE	N/A	TEST POINT; PIN DIA=0.125IN; TOTAL LENGTH=0.35IN; BOARD HOLE=0.063IN; WHITE; PHOSPHOR BRONZE WIRE SILVER PLATE FINISH;
68	TP39, TP102, TP106, TP111	-	4	5011	KEYSTONE	N/A	TEST POINT; PIN DIA=0.125IN; TOTAL LENGTH=0.445IN; BOARD HOLE=0.063IN; BLACK; PHOSPHOR BRONZE WIRE SILVER PLATE FINISH;
69	TP101	-	1	5128	KEYSTONE	N/A	TEST POINT; PIN DIA=0.125IN; TOTAL LENGTH=0.445IN; BOARD HOLE=0.063IN; GREY; PHOSPHOR BRONZE WIRE SILVER PLATE FINISH;
70	TP103	-	1	5010	KEYSTONE	N/A	TEST POINT; PIN DIA=0.125IN; TOTAL LENGTH=0.445IN; BOARD HOLE=0.063IN; RED; PHOSPHOR BRONZE WIRE SIL;
71	TP110	-	1	5013	KEYSTONE	N/A	TEST POINT; PIN DIA=0.125IN; TOTAL LENGTH=0.445IN; BOARD HOLE=0.063IN; ORANGE; PHOSPHOR BRONZE WIRE SILVER PLATE FINISH;
72	TP120	-	1	5126	KEYSTONE	N/A	TEST POINT; PIN DIA=0.125IN; TOTAL LENGTH=0.445IN; BOARD HOLE=0.063IN; GREEN; PHOSPHOR BRONZE WIRE SILVER PLATE FINISH;
73	TP150	-	1	5125	KEYSTONE	N/A	TEST POINT; PIN DIA=0.125IN; TOTAL LENGTH=0.445IN; BOARD HOLE=0.063IN; BROWN; PHOSPHOR BRONZE WIRE SILVER PLATE FINISH;
74	TVS1	-	1	SMM4F33A	ST MICROELECTRONICS	33V	DIODE; TVS; SMT (DO-216AA); VRM=33V; IPP=7A
75	U1	-	1	MAX22005	MAXIM	MAX22005	EVKIT PART - IC; RX16; TWELVE-CHANNEL FACTORY-CALIBRATED CONFIGURABLE INDUSTRIAL ANALOG INPUT; QFN48
76	U3	-	1	MAX14761ETB+	MAXIM	MAX14761ETB+	IC; ASW; ABOVE- AND BELOW-THE-RAILS LOW ON-RESISTANCE ANALOG SWITCH; TDFN10-EP
77	U10, U20	-	2	MAX17530ATB+	MAXIM	MAX17530ATB+	IC; CONV; 42V; 0.025A; ULTRA-SMALL; HIGH-EFFICIENCY; SYNCHRONOUS STEP-DOWN DC-DC CONVERTER; TDFN10-EP 3X2
78	U50	-	1	MAXM17552AMB+	MAXIM	MAXM17552AMB+	IC; PWM; 4V TO 60V; 100MA; COMPACT STEP-DOWN POWER MODULE; USLIC-10
79	U80	-	1	MAX6126AASA25+	MAXIM	MAX6126AASA25+	IC; VREF; ULTRA HIGH PRECISION; ULTRA LOW NOISE VOLTAGE REFERENCE; SOIC8 150MIL; VOUT=2.5V, 3PPM/DEGC MAX TEMPCO; NSOIC8
80	U201, U202	-	2	MAX14483AAP+	MAXIM	MAX14483AAP+	IC; DISO; 6-CHANNEL; LOW-POWER; 3.75KV/RMS SPI DIGITAL ISOLATOR; SSOP20
81	U203	-	1	FT2232HQ	FUTURE TECHNOLOGY DEVICES INTL LTD.	FT2232HQ	IC; MMRV; DUAL HIGH SPEED USB TO MULTIPURPOSE UART/FIFO; QFN64-EP
82	U204	-	1	93LC66BT-I/OT	MICROCHIP	93LC66BT-I/OT	IC; EPROM; 4K MICROWIRE SERIAL EEPROM; SOT23-6
83	U205	-	1	MAX1556ETB+	MAXIM	MAX1556ETB+	IC; CONV; PWM STEP-DOWN DC-DC CONVERTER; TDFN10-EP 3X3
84	U206	-	1	M25P16-VMW6TG	MICRON TECHNOLOGY INC.	M25P16-VMW6TG	IC; MMRV; 16MBIT; SERIAL FLASH MEMORY; 75MHZ SPI BUS INTERFACE; MSOIC8 200MIL
85	X1-X3	-	3	282834-9	TE CONNECTIVITY	282834-9	CONNECTOR; FEMALE; THROUGH HOLE; 2.54MM PITCH SIDE WIRE ENTRY STACKING TERMINAL BLOCK; STRAIGHT; 9PINS
86	Y1	-	1	ABM7-12.000MHZ-D2Y-T	ABRACON	12MHZ	CRYSTAL; SMT ; 18PF; 12MHZ; +/-20PPM; +/-30PPM
87	Y2	-	1	ASE-7.3728MHZ-L-C	ABRACON	7.3728MHZ	CRYSTAL; SMT; 15PF; 7.3728MHZ; +/-50PPM
88	PCB	-	1	MAX22005	MAXIM	PCB	PCB:MAX22005
89	C21	DNP	0	GRM188R70J105KA01; CL10B105KQ8NNNC	MURATA;SAMSUNG ELECTRONICS	1.0UF	CAP; SMT (0603); 1.0UF; 10%; 6.3V; X7R; CERAMIC;
90	R13	DNP	0	N/A	N/A	SHORT	PACKAGE OUTLINE 0402 RESISTOR
TOTAL			233				

MAX22005 EV Kit Schematic

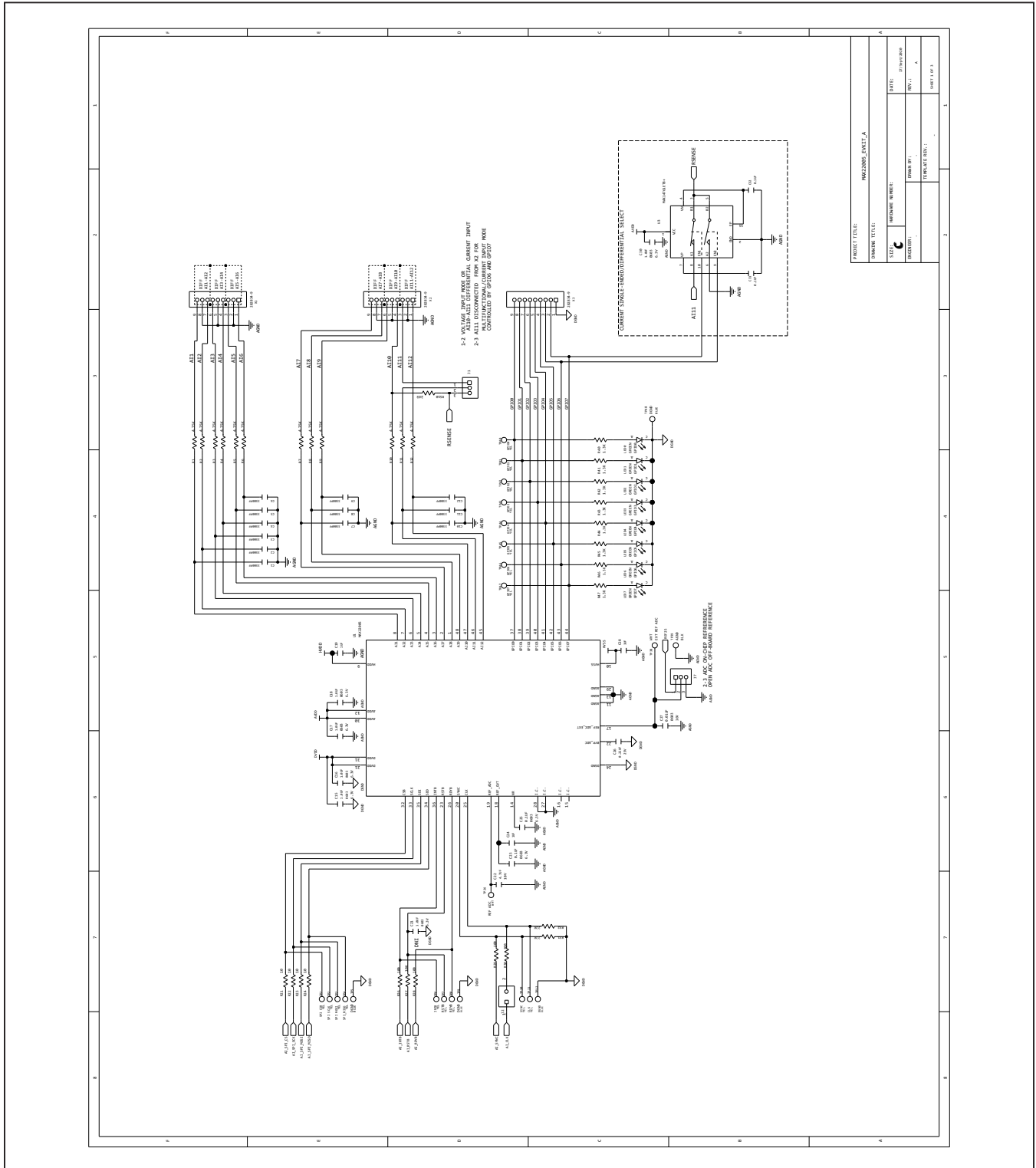

MAX22005 EV Kit Schematic (continued)

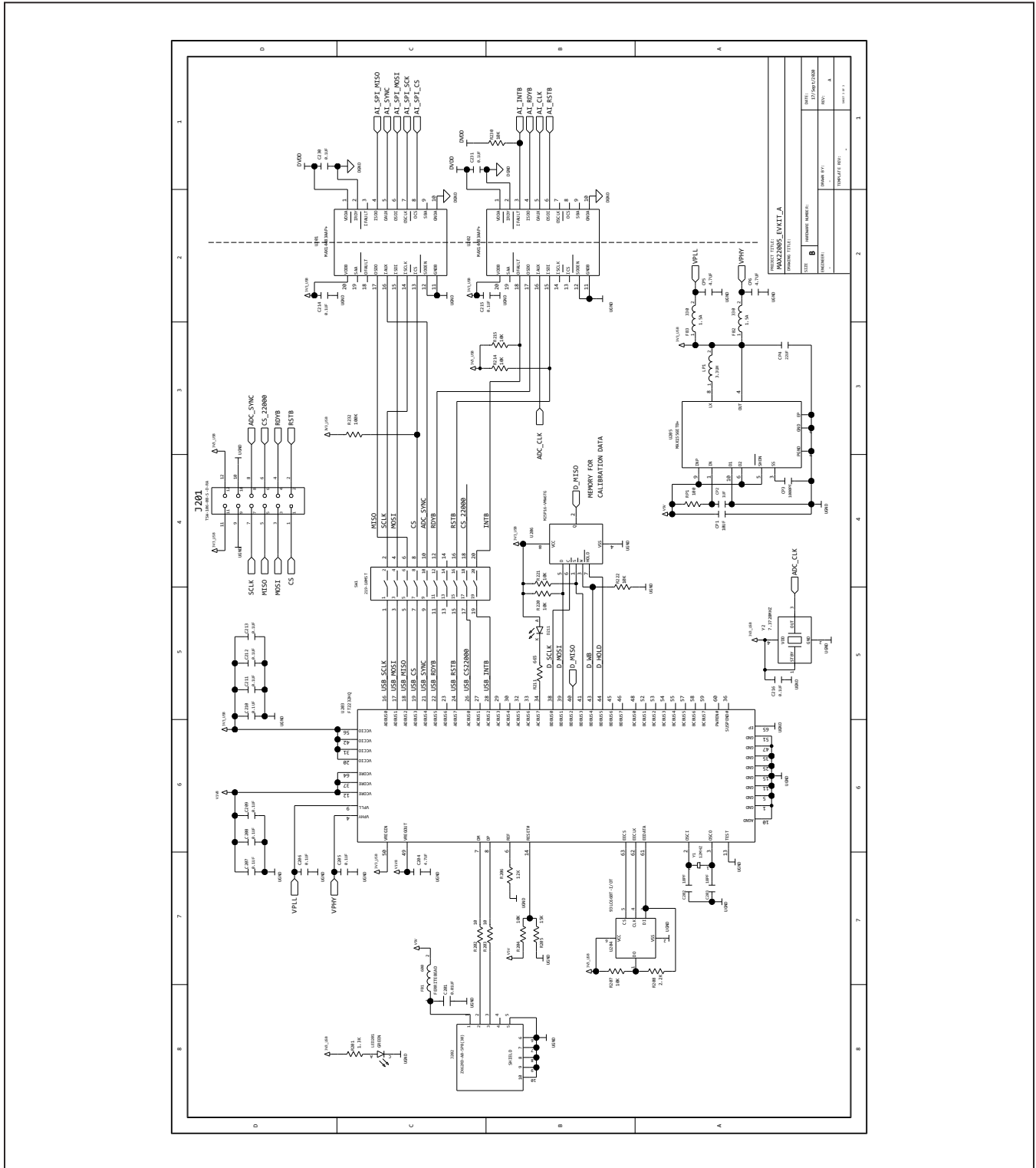

MAX22005 EV Kit PCB Layout Diagrams

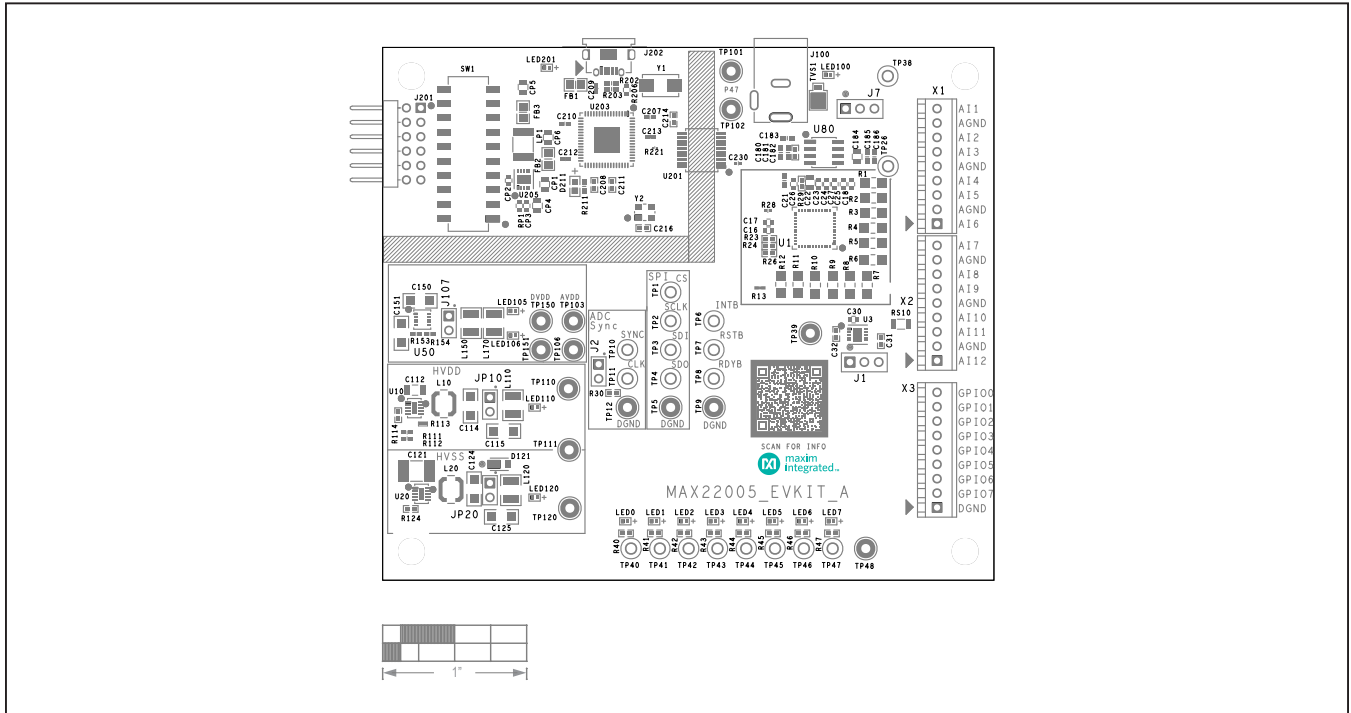

MAX22005 EV Kit PCB Layout—Silkscreen Top

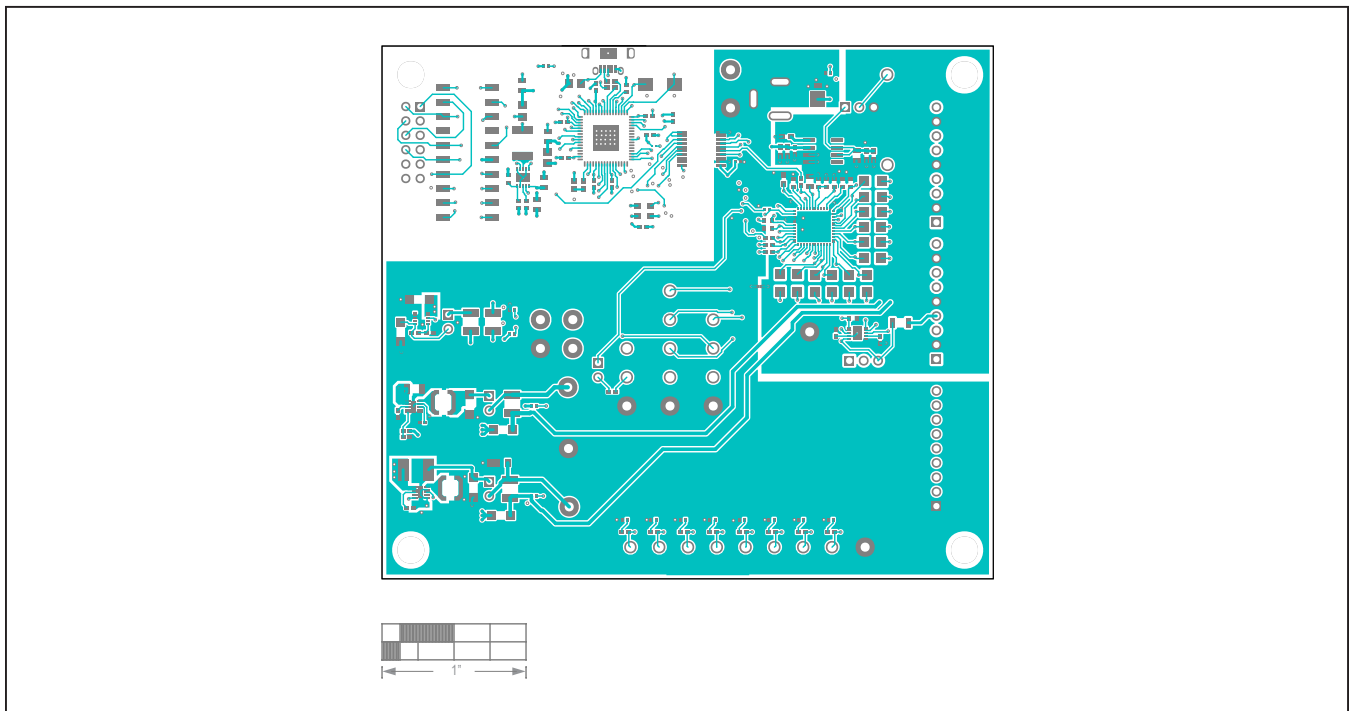

MAX22005 EV Kit PCB Layout—Top Layer

MAX22005 EV Kit PCB Layout Diagrams (continued)

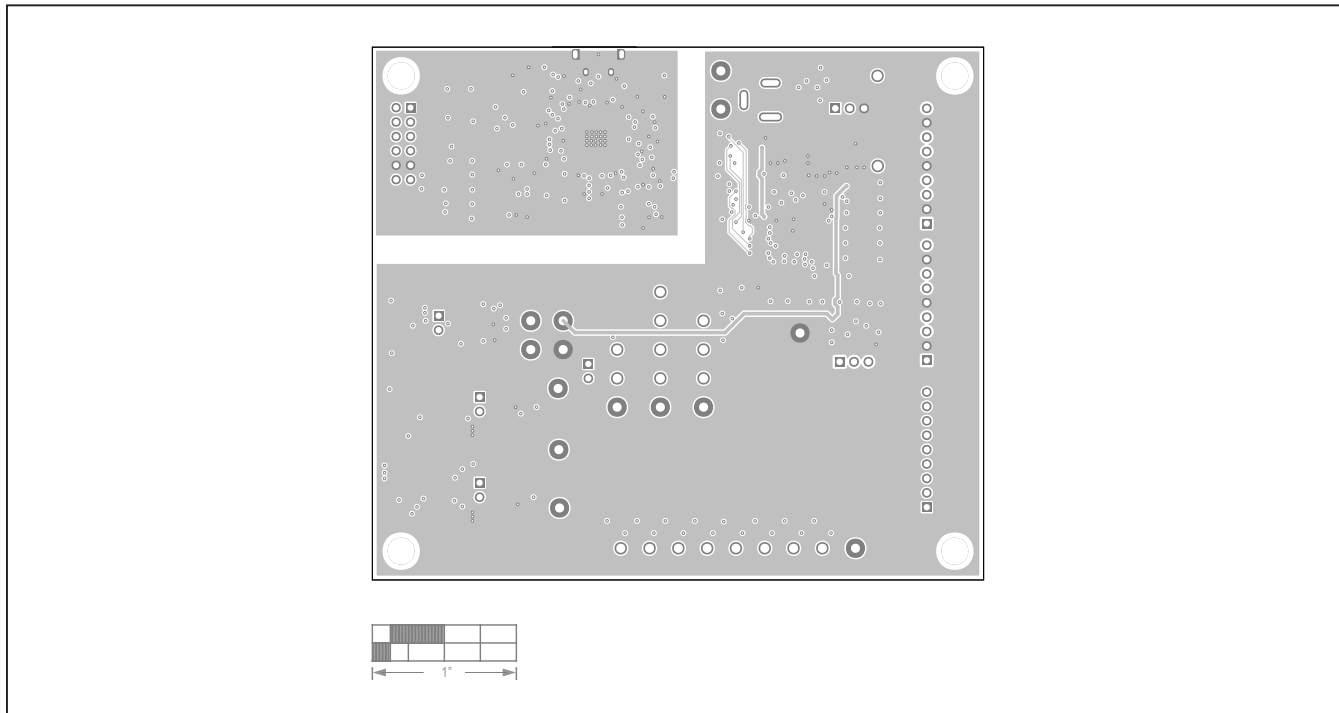

MAX22005 EV Kit PCB Layout—Layer 2

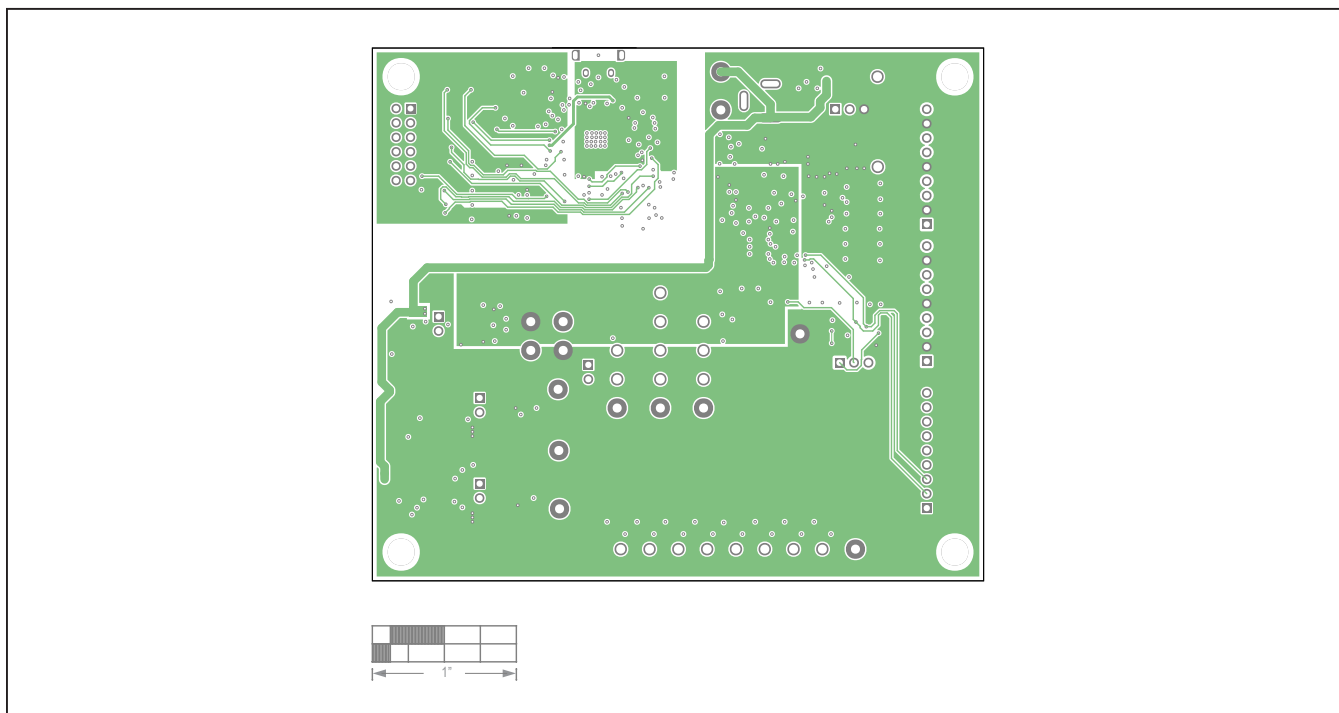

MAX22005 EV Kit PCB Layout—Layer 3

Revision History

REVISION NUMBER	REVISION DATE	DESCRIPTION	PAGES CHANGED
0	3/21	Initial release	—

For pricing, delivery, and ordering information, please visit Maxim Integrated's online storefront at <https://www.maximintegrated.com/en/storefront/storefront.html>.

Maxim Integrated cannot assume responsibility for use of any circuitry other than circuitry entirely embodied in a Maxim Integrated product. No circuit patent licenses are implied. Maxim Integrated reserves the right to change the circuitry and specifications without notice at any time.