

Altivar Machine 320

Variable Speed Drives for Asynchronous and Synchronous motors.

EtherCAT Manual - VW3A3601

03/2017



The information provided in this documentation contains general descriptions and/or technical characteristics of the performance of the products contained herein. This documentation is not intended as a substitute for and is not to be used for determining suitability or reliability of these products for specific user applications. It is the duty of any such user or integrator to perform the appropriate and complete risk analysis, evaluation and testing of the products with respect to the relevant specific application or use thereof. Neither Schneider Electric nor any of its affiliates or subsidiaries shall be responsible or liable for misuse of the information contained herein. If you have any suggestions for improvements or amendments or have found errors in this publication, please notify us.

No part of this document may be reproduced in any form or by any means, electronic or mechanical, including photocopying, without express written permission of Schneider Electric.

All pertinent state, regional, and local safety regulations must be observed when installing and using this product. For reasons of safety and to help ensure compliance with documented system data, only the manufacturer should perform repairs to components.

When devices are used for applications with technical safety requirements, the relevant instructions must be followed.

Failure to use Schneider Electric software or approved software with our hardware products may result in injury, harm, or improper operating results.

Failure to observe this information can result in injury or equipment damage.

© 2017 Schneider Electric. All Rights Reserved.

Table of Contents



	Safety Information	5
	About the Book	9
Chapter 1	Presentation	13
	Hardware Overview	14
	Software Overview	15
Chapter 2	Basics	17
	Object Dictionary	18
	Service Data Communication	19
	Process Data Communication	19
	EtherCAT State Machine	20
Chapter 3	Hardware Setup	23
	Hardware Presentation	24
	Firmware and Description File	24
	Installation of the Module	25
	Electrical Installation	26
	Cable Routing Practices	27
Chapter 4	Software Setup	29
4.1	Basic Settings	30
	Configuring the Communication Parameters	31
	[EthCat slave status] E C S S	31
	[EthCat 2nd addr] E C S R	32
	[EthCat addr] E C R R	32
4.2	Profile	33
	Definition of a Profile	34
	Functional Profiles Supported by the Drive	35
	Functional Description	36
	CIA402 Operating State Diagram	37
	Description of Operating States	38
	Summary	40
	Cmd Register C P d	41
	Stop Commands	42
	Assigning Control Word Bits	42
	[CIA402 State Reg] E E R	43
	Starting Sequence	44
	Sequence for a Drive Powered by the Power Stage Supply	45
	Sequence for a Drive with Separate Control Stage	46
	Sequence for a Drive with Mains Contactor Control	49
4.3	Software Setup with TwinCAT	51
	Introduction	52
	TwinCAT® Configuration	53
4.4	Software Setup for SoMove Ethernet over EtherCAT Connection	61
	Introduction	62
	Ethernet Configuration	63
	EtherCAT Configuration	64
	PLC Configuration	67
	SoMove Connection Through EoE	71
Chapter 5	Operation	73
5.1	Operating States	74
	Configuring Communication Error Response	74

5.2	Operating Modes	75
	Configuring the Control Channel	76
	Configuration of the Drive for Operation in I/O Profile	77
	Configuration of the Drive for Operation with CiA 402 Profile in Combined Mode.....	78
	Configuration of the Drive for Operation with CiA 402 Profile in Separate Mode.....	79
Chapter 6	Diagnostics and Troubleshooting	81
	Fieldbus Status LEDs	82
	Connection for Fieldbus Mode	84
	Monitoring of Communication Channel	85
	Control-Signal Diagnostics.....	87
Glossary	89



Important Information

NOTICE

Read these instructions carefully, and look at the equipment to become familiar with the device before trying to install, operate, service, or maintain it. The following special messages may appear throughout this documentation or on the equipment to warn of potential hazards or to call attention to information that clarifies or simplifies a procedure.



The addition of this symbol to a “Danger” or “Warning” safety label indicates that an electrical hazard exists which will result in personal injury if the instructions are not followed.



This is the safety alert symbol. It is used to alert you to potential personal injury hazards. Obey all safety messages that follow this symbol to avoid possible injury or death.

DANGER

DANGER indicates a hazardous situation which, if not avoided, **will result in** death or serious injury.

WARNING

WARNING indicates a hazardous situation which, if not avoided, **could result in** death or serious injury.

CAUTION

CAUTION indicates a hazardous situation which, if not avoided, **could result in** minor or moderate injury.

NOTICE

NOTICE is used to address practices not related to physical injury.

PLEASE NOTE

Electrical equipment should be installed, operated, serviced, and maintained only by qualified personnel. No responsibility is assumed by Schneider Electric for any consequences arising out of the use of this material.

A qualified person is one who has skills and knowledge related to the construction and operation of electrical equipment and its installation, and has received safety training to recognize and avoid the hazards involved.

Qualification Of Personnel

Only appropriately trained persons who are familiar with and understand the contents of this manual and all other pertinent product documentation are authorized to work on and with this product. In addition, these persons must have received safety training to recognize and avoid hazards involved. These persons must have sufficient technical training, knowledge and experience and be able to foresee and detect potential hazards that may be caused by using the product, by changing the settings and by the mechanical, electrical and electronic equipment of the entire system in which the product is used. All persons working on and with the product must be fully familiar with all applicable standards, directives, and accident prevention regulations when performing such work.

Intended Use

This product is a drive for three-phase asynchronous motors and intended for industrial use according to this manual. The product may only be used in compliance with all applicable safety standard and local regulations and directives, the specified requirements and the technical data. The product must be installed outside the hazardous ATEX zone. Prior to using the product, you must perform a risk assessment in view of the planned application. Based on the results, the appropriate safety measures must be implemented. Since the product is used as a component in an entire system, you must ensure the safety of persons by means of the design of this entire system (for example, machine design). Any use other than the use explicitly permitted is prohibited and can result in hazards. Electrical equipment should be installed, operated, serviced, and maintained only by qualified personnel.

Product Related Information

Read and understand these instructions before performing any procedure with this drive.

 DANGER
HAZARD OF ELECTRIC SHOCK, EXPLOSION OR ARC FLASH
<ul style="list-style-type: none">• Only appropriately trained persons who are familiar with and understand the contents of this manual and all other pertinent product documentation and who have received safety training to recognize and avoid hazards involved are authorized to work on and with this drive system. Installation, adjustment, repair and maintenance must be performed by qualified personnel.• The system integrator is responsible for compliance with all local and national electrical code requirements as well as all other applicable regulations with respect to grounding of all equipment.• Many components of the product, including the printed circuit boards, operate with mains voltage. Do not touch. Use only electrically insulated tools.• Do not touch unshielded components or terminals with voltage present.• Motors can generate voltage when the shaft is rotated. Prior to performing any type of work on the drive system, block the motor shaft to prevent rotation.• AC voltage can couple voltage to unused conductors in the motor cable. Insulate both ends of unused conductors of the motor cable.• Do not short across the DC bus terminals or the DC bus capacitors or the braking resistor terminals.• Before performing work on the drive system:<ul style="list-style-type: none">○ Disconnect all power, including external control power that may be present.○ Place a Do Not Turn On label on all power switches.○ Lock all power switches in the open position.○ Wait 15 minutes to allow the DC bus capacitors to discharge. The DC bus LED is not an indicator of the absence of DC bus voltage that can exceed 800 Vdc. Measure the voltage on the DC bus between the DC bus terminals (PA+, PC/-) using a properly rated voltmeter to verify that the voltage is <42 Vdc○ If the DC bus capacitors do not discharge properly, contact your local Schneider Electric representative. Do not repair or operate the product.• Install and close all covers before applying voltage.
Failure to follow these instructions will result in death or serious injury.

Drive systems may perform unexpected movements because of incorrect wiring, incorrect settings, incorrect data or other errors.

 WARNING
UNANTICIPATED EQUIPMENT OPERATION
<ul style="list-style-type: none">• Carefully install the wiring in accordance with the EMC requirements.• Do not operate the product with unknown or unsuitable settings or data.• Perform a comprehensive commissioning test.
Failure to follow these instructions can result in death, serious injury, or equipment damage.

Damaged products or accessories may cause electric shock or unanticipated equipment operation.

DANGER

ELECTRIC SHOCK OR UNANTICIPATED EQUIPMENT OPERATION

Do not use damaged products or accessories.

Failure to follow these instructions will result in death or serious injury.

Contact your local Schneider Electric sales office if you detect any damage whatsoever.

WARNING

LOSS OF CONTROL

- The designer of any control scheme must consider the potential failure modes of control paths and, for critical control functions, provide a means to achieve a safe state during and after a path failure. Examples of critical control functions are emergency stop, overtravel stop, power outage and restart.
- Separate or redundant control paths must be provided for critical control functions.
- System control paths may include communication links. Consideration must be given to the implications of unanticipated transmission delays or failures of the link.
- Observe all accident prevention regulations and local safety guidelines (1).
- Each implementation of the product must be individually and thoroughly tested for proper operation before being placed into service.

Failure to follow these instructions can result in death, serious injury, or equipment damage.

(1) For USA: Additional information, refer to NEMA ICS 1.1 (latest edition), Safety Guidelines for the Application, Installation, and Maintenance of Solid State Control and to NEMA ICS 7.1 (latest edition), Safety Standards for Construction and Guide for Selection, Installation and Operation of Adjustable-Speed Drive Systems.

NOTICE

DESTRUCTION DUE TO INCORRECT MAINS VOLTAGE

Before switching on and configuring the product, verify that it is approved for the mains voltage

Failure to follow these instructions can result in equipment damage.

The temperature of the products described in this manual may exceed 80 °C (176 °F) during operation.

WARNING

HOT SURFACES

- Ensure that any contact with hot surfaces is avoided.
- Do not allow flammable or heat-sensitive parts in the immediate vicinity of hot surfaces.
- Verify that the product has sufficiently cooled down before handling it.
- Verify that the heat dissipation is sufficient by performing a test run under maximum load conditions.

Failure to follow these instructions can result in death, serious injury, or equipment damage.

The product is not approved for use in hazardous areas (explosive atmospheres).

WARNING

EXPLOSION HAZARD

Only use this device outside of hazardous areas (explosive atmospheres).

Failure to follow these instructions can result in death, serious injury, or equipment damage.

Machines, controllers, and related equipment are usually integrated into networks. Unauthorized persons and malware may gain access to the machine as well as to other devices on the network/fieldbus of the machine and connected networks via insufficiently secure access to software and networks.

 WARNING

UNAUTHORIZED ACCESS TO THE MACHINE VIA SOFTWARE AND NETWORKS

- In your hazard and risk analysis, consider all hazards that result from access to and operation on the network/fieldbus and develop an appropriate cyber security concept.
- Verify that the hardware infrastructure and the software infrastructure into which the machine is integrated as well as all organizational measures and rules covering access to this infrastructure consider the results of the hazard and risk analysis and are implemented according to best practices and standards covering IT security and cyber security (such as: ISO/IEC 27000 series, Common Criteria for Information Technology Security Evaluation, ISO/ IEC 15408, IEC 62351, ISA/IEC 62443, NIST Cybersecurity Framework, Information Security Forum - Standard of Good Practice for Information Security).
- Verify the effectiveness of your IT security and cyber security systems using appropriate, proven methods.

Failure to follow these instructions can result in death, serious injury, or equipment damage.

About the Book



At a Glance

Document Scope

The purpose of this document is to:

- Show you how to connect the EtherCAT fieldbus on your drive.
- Show you how to set up the drive to use EtherCAT for display, monitoring, and control.
- Provide examples of setup using the commissioning software

NOTE: Read and understand this document and all related documents (see below) before installing, operating, or maintaining your drive.

Validity Note

This documentation is valid for the Altivar Machine drives.

The technical characteristics of the devices described in this document also appear online. To access this information online:

Step	Action
1	Go to the Schneider Electric home page www.schneider-electric.com .
2	In the Search box type the reference of a product or the name of a product range. <ul style="list-style-type: none">• Do not include blank spaces in the reference or product range.• To get information on grouping similar modules, use asterisks (*).
3	If you entered a reference, go to the Product Datasheets search results and click on the reference that interests you. If you entered the name of a product range, go to the Product Ranges search results and click on the product range that interests you.
4	If more than one reference appears in the Products search results, click on the reference that interests you.
5	Depending on the size of your screen, you may need to scroll down to see the data sheet.
6	To save or print a data sheet as a .pdf file, click Download XXX product datasheet .

The characteristics that are presented in this manual should be the same as those characteristics that appear online. In line with our policy of constant improvement, we may revise content over time to improve clarity and accuracy. If you see a difference between the manual and online information, use the online information as your reference.

Related Documents

Use your tablet or your PC to quickly access detailed and comprehensive information on all our products on www.schneider-electric.com

The Internet site provides the information you need for products and solutions

- The whole catalog for detailed characteristics and selection guides
- The CAD files to help design your installation, available in over 20 different file formats
- All software and firmware to maintain your installation up to date
- A large quantity of White Papers, Environment documents, Application solutions, Specifications... to gain a better understanding of our electrical systems and equipment or automation
- And finally all the User Guides related to your drive, listed below:

Title of Documentation	Reference Number
ATV320 Getting Started	NVE21763 (English), NVE21771 (French), NVE21772 (German), NVE21773 (Spanish), NVE21774 (Italian), NVE21776 (Chinese)
ATV320 Getting Started Annex (SCCR)	NVE21777 (English)
ATV320 Installation manual	NVE41289 (English), NVE41290 (French), NVE41291 (German), NVE41292 (Spanish), NVE41293 (Italian), NVE41294 (Chinese)
ATV320 Programming manual	NVE41295 (English), NVE41296 (French), NVE41297 (German), NVE41298 (Spanish), NVE41299 (Italian), NVE41300 (Chinese)
ATV320 Modbus Serial Link manual (embedded)	NVE41308 (English)
ATV320 Modbus TCP - Ethernet IP manual (VW3A3616)	NVE41313 (English)
ATV320 PROFIBUS DP manual (VW3A3607)	NVE41310 (English)
ATV320 DeviceNet manual (VW3A3609)	NVE41314 (English)
ATV320 CANopen manual (VW3A3608, 618, 628)	NVE41309 (English)
ATV320 POWERLINK manual (VW3A3619)	NVE41312 (English)
ATV320 EtherCAT manual (VW3A3601)	NVE41315 (English)
ATV320 Communication Parameters	NVE41316 (English)
ATV320 Safety Functions manual	NVE50467 (English), NVE50468 (French), NVE50469 (German), NVE50470 (Spanish), NVE50472 (Italian), NVE50473 (Chinese)
BMP Synchronous Motor manual	0198441113981-EN (English), 0198441113982-FR (French), 0198441113980-DE (German), 0198441113984-ES (Spanish), 0198441113983-IT (Italian), 0198441113985-ZH (Chinese)
ATV320 ATV Logic manual	NVE71954 (English), NVE71955 (French), NVE71957 (German), NVE71959 (Spanish), NVE71958 (Italian), NVE71960 (Chinese)
SoMove: FDT	SoMove FDT (English, French, German, Spanish, Italian, Chinese)
ATV320: DTM	ATV320 DTM Library (English, French, German, Spanish, Italian, Chinese)

You can download these technical publications and other technical information from our website at <http://www.schneider-electric.com/en/download>

Terminology

The technical terms, terminology, and the corresponding descriptions in this manual normally use the terms or definitions in the relevant standards.

In the area of drive systems this includes, but is not limited to, terms such as **error, error message, failure, fault, fault reset, protection, safe state, safety function, warning, warning message**, and so on.

Among others, these standards include:

- IEC 61800 series: Adjustable speed electrical power drive systems
- IEC 61508 Ed.2 series: Functional safety of electrical/electronic/programmable electronic safety-related
- EN 954-1 Safety of machinery - Safety related parts of control systems
- EN ISO 13849-1 & 2 Safety of machinery - Safety related parts of control systems.
- IEC 61158 series: Industrial communication networks - Fieldbus specifications
- IEC 61784 series: Industrial communication networks - Profiles
- IEC 60204-1: Safety of machinery - Electrical equipment of machines – Part 1: General requirements

In addition, the term **zone of operation** is used in conjunction with the description of specific hazards, and is defined as it is for a **hazard zone** or **danger zone** in the EC Machinery Directive (2006/42/EC) and in ISO 12100-1.

Also see the glossary at the end of this manual.

Chapter 1

Presentation

What Is in This Chapter?

This chapter contains the following topics:

Topic	Page
Hardware Overview	14
Software Overview	15

Hardware Overview

General

The VW3A3601 is a dual port EtherCAT fieldbus module that can be used in an EtherCAT industrial fieldbus.

The following figure shows the hardware presentation of the VW3A3601 dual port EtherCAT module.



Software Overview

General

EtherCAT manages communication between the network devices with object dictionaries and objects. A network device can use process data objects (PDO) and service data objects (SDO) to request the object data from the object dictionary of another device and, if permissible, write back modified values.

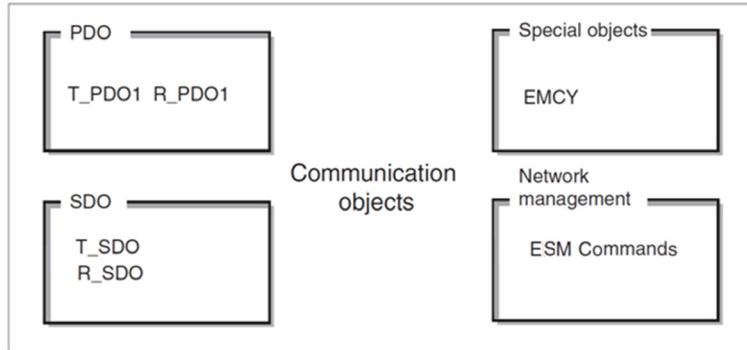

- PDOs (process data objects) for real-time transmission of process data.
- SDOs (service data object) for read and write access to the object dictionary.
- Objects for controlling EtherCAT message, EMCY object (emergency object), for signaling errors of a device or its peripherals.
- Network management service, ESM commands for initialization and network control.

NOTE: EtherCAT® is registered trademark and patented technology, licensed by Beckhoff Automation GmbH, Germany.

Chapter 2

Basics

What Is in This Chapter?

This chapter contains the following topics:

Topic	Page
Object Dictionary	18
Service Data Communication	19
Process Data Communication	19
EtherCAT State Machine	20

Object Dictionary

Description

Each EtherCAT device manages an object dictionary which contains the objects for communication.

Index and Subindex

The objects are addressed in the object dictionary via a 16 bit index.

One or more 8 bit subindex entries for each object specify individual data fields in the object. Index and subindex are shown in hexadecimal notation.

The following table provides the index and subindex entries using the example of the object ramps (203C hex):

Index	Subindex	Name	Meaning
203C hex	00 hex	–	Number of entries
203C hex	01 hex	ACC	Acceleration time
203C hex	02 hex	DEC	Deceleration time

Description Object Dictionary

The description object dictionary is made of separate chapters:

- Communication profile area
- RPDO
- TPDO
- Manufacturer specific
- Application profile (CiA402)

Index (hex)	Object
0000	Unused
0001...001F	Static data types
0020...003F	Complex data types
0040...005F	Unused (Manufacturer-specific complex data types)
0060...007F	Device profile-specific static data types
0080...009F	Device profile-specific complex data types
00A0...0FFF	Reserved for further use
1000...1FFF	Communication profile area
2000...5FFF	ATV320 specific profile area
6000...9FFF	Standardized device profile area
A000...FFFF	Reserved for further use

Service Data Communication

Description

Service Data Objects (SDO) can be used to access the entries of an object dictionary using index and subindex. The values of the objects can be read and, if permissible, also written.

Every network device has at least one SDO server to be able to respond to read and write requests from a different device.

The TSDO of a SDO client is used to send the request for data exchange; the RSDO is used to receive.

Process Data Communication

Description

Process Data Objects (PDO) are used for real-time data exchange of process data such as actual and reference values or the operating state of the device. Transmission is fast because the data is sent without administration data and data transmission acknowledgment from the recipient is not required. Each PDO can be enabled or disabled independently using the bit 31 (valid bit) in subindex 01 hex of the respective communication object.

PDO Overview

By default, the PDO is compliant with Velocity mode of the CiA402.

PDO Configuration

By default, the PDO is configured as followed:

CMD	LFRD	OCA3	OCA4	OCA5	OCA6	= RPDO
ETA	RFRD	OMA3	OMA4	OMA5	OMA6	= TPDO

The configuration of the PDO can be achieved using EtherCAT configuration tool

EtherCAT State Machine

ESM Chart

The EtherCAT State Machine (ESM) coordinates the master and slave applications at start-up and during operation. State changes are typically initiated by requests of the master. They are acknowledged by the local application after the associated operations have been executed.

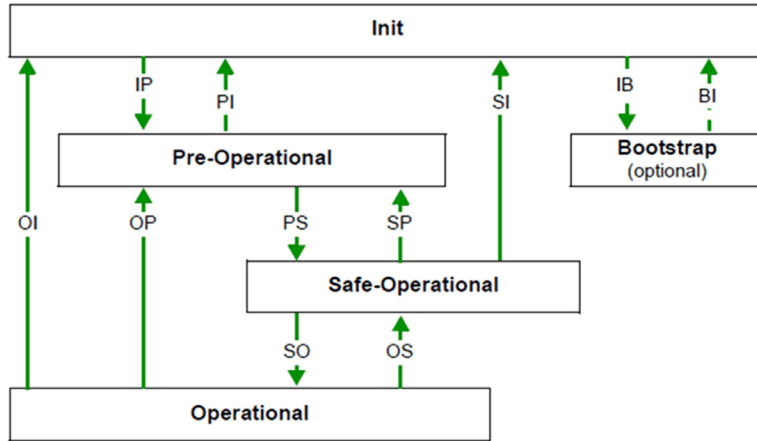

ESM States Description

The state **Init** defines the foundation of the communication relationship between the master and the slaves at the application layer. Direct communication between the master and the slave is impossible at the application layer. The master uses the Init state to initialize a set of configuration registers of the EtherCAT slave controllers. If the slaves support mailbox services, the Sync Manager is also configured in this state.

In the **Pre-Operational** state, the mailbox is active. Both master and slave use the mailbox and the corresponding protocol to interchange application-specific initialization data and parameters. In this state, process data communication is not possible. If the drive does not receive a valid mapping for the process data from the EtherCAT master, it remains in this state.

In the **Safe-Operational** state, the slave application provides current input data such as limit switch data. Output data of the master are ignored in this state. This state is not a safety function.

In the state **Operational**, the slave applications deliver current input data and the drive processes the current output data from the drive, such as target positions.

NOTE: If the PDO is deactivated, it is not possible to control the drive by the SDO.

ESM Transitions

The following table displays the services started or stopped following a state transition.

State transition	Local management service
IP	Start Mailbox Communication
PI	Stop Mailbox Communication
PS	Start Input Update
SP	Stop Input Update
SO	Start Output Update
OS	Stop Output Update
OP	Stop Output Update and Stop Input Update
SI	Stop Input Update and Stop Mailbox Communication
OI	Stop Output Update and Stop Mailbox Communication
IB	Start Bootstrap Mode, redirection to BI
BI	Restart Device

ESM States and Communication Interruptions

Some transitions in the ESM state chart triggers a communication interruption.

The following table shows the transitions that suppress a service which can be used to control the drive. An error is triggered in order to avoid losing control of the drive (only if the drive is running).

State transition	Service lost	Error detected
PI	SDO	No possible CnF
SI	SDO, TPDO	
SP	TPDO	
OS	RPDO	If drive was enabled (EtA = xxx7 hex), then the CnF value is updated to 60 hex
OP	PDO	
OI	SDO, PDO	

Depending on the ESM state of the drive, the following services are available:

	Init	Pre-Operational	Safe-Operational	Operational
PDO	–	–	TPDO, inputs only active, no outputs to drive active	X
SDO	–	X	X	X
Emergency (EMCY)	–	X	X	X
X: Service is active –: Service is not active				

Chapter 3

Hardware Setup

What Is in This Chapter?

This chapter contains the following topics:

Topic	Page
Hardware Presentation	24
Firmware and Description File	24
Installation of the Module	25
Electrical Installation	26
Cable Routing Practices	27

Hardware Presentation

EtherCAT Fieldbus Modules

The following figure shows the VW3A3601 EtherCAT module with 2 RJ45 connectors:

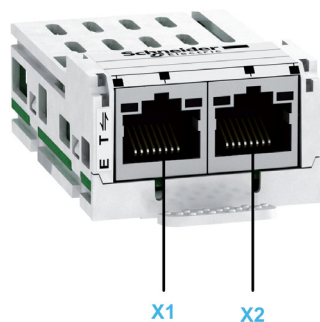

Item	Description	Comment
X1	EtherCAT IN	RJ45 connector (X1)
X2	EtherCAT OUT	RJ45 connector (X2)

Firmware and Description File

ESI File

The associated ESI (EtherCAT slave information) file is named as the following example:

Schneider_Electric_ATV320_V108.xml

The files are available on www.schneider-electric.com.

NOTE: The files must be copied on the TwinCAT installation folder. By default: C:\TwinCAT\Io\EtherCAT

Installation of the Module

Before Starting

Check that the module catalog number marked on the label is the same as that on the delivery note corresponding to the purchase order.

Remove the fieldbus module from its packaging and check that it has not been damaged in transit.

Insertion of the Fieldbus Module

The table provides the procedure for insertion of the EtherCAT option module in the drive:

Step	Action
1	Ensure that the power is off.
2	Locate the fieldbus module slot (A).
3	Insert the module.
4	Check that the module is correctly inserted and locked mechanically in the drive.

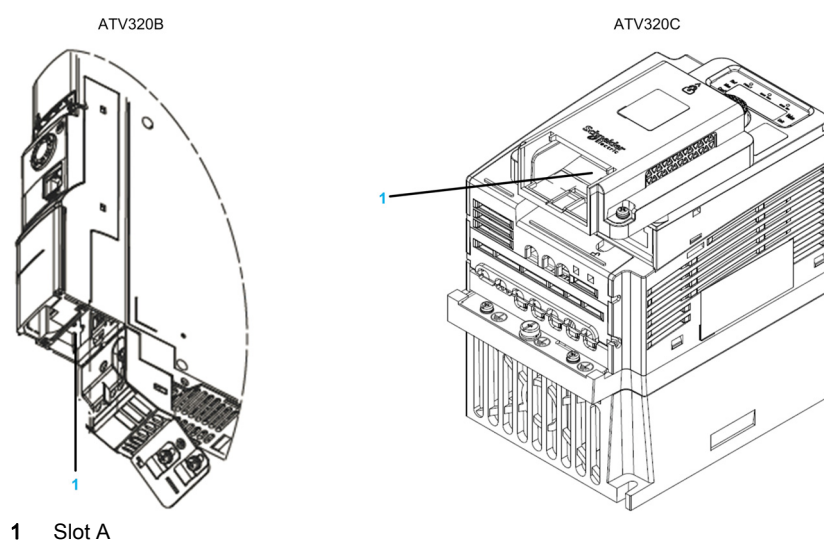

1 Slot A

Removal of the Fieldbus Module

The table provides the procedure for removal of the EtherCAT option module from the drive:

Step	Action
1	Ensure that the power is off.
2	Press the strip.
3	Remove the module while maintaining the strip pressed,

Electrical Installation

Pin Layout of VW3A3601

The VW3A3601 option module is equipped with 2 RJ45 female sockets for the EtherCAT connection.

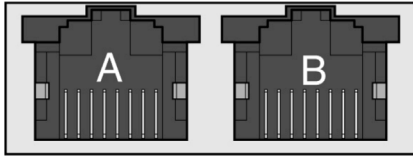

8 7 6 5 4 3 2 1 8 7 6 5 4 3 2 1

The table provides the port details

Port	Fieldbus
A	EtherCAT X1
B	EtherCAT X2

The table provides the pin out details of each RJ45 connector:

Pin	RJ45 signal
1	Tx+: Ethernet transmit line +
2	Tx-: Ethernet transmit line -
3	Rx+: Ethernet receive line +
4	Not connected
5	Not connected
6	Rx-: Ethernet receive line -
7	Not connected
8	Not connected

Cable Specification

Cable specifications are as follows:

- Minimum Cat 5e
- Use equipotential bonding conductors (100 BASE-TX, category 5e, or industrial Ethernet fast connect)
- Connector RJ45, no crossover cable
- Shields: both ends grounded
- Twisted-pair cable
- Verify that wiring, cables, and connected interfaces meet the PELV requirements
- Maximum cable length per segment = 100 m (328 ft)/6 plugs

Cable Routing Practices

Installation Topology

The following images show the connection of multiple drives equipped with VW3A3601 EtherCAT modules.

Daisy chain and/or star topology

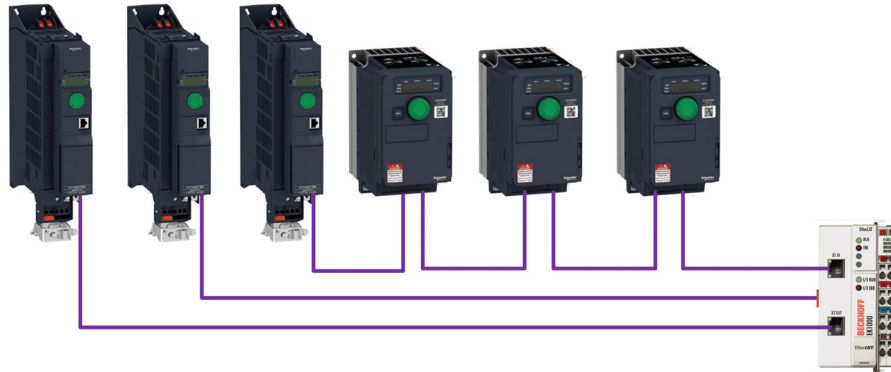

Ring topology

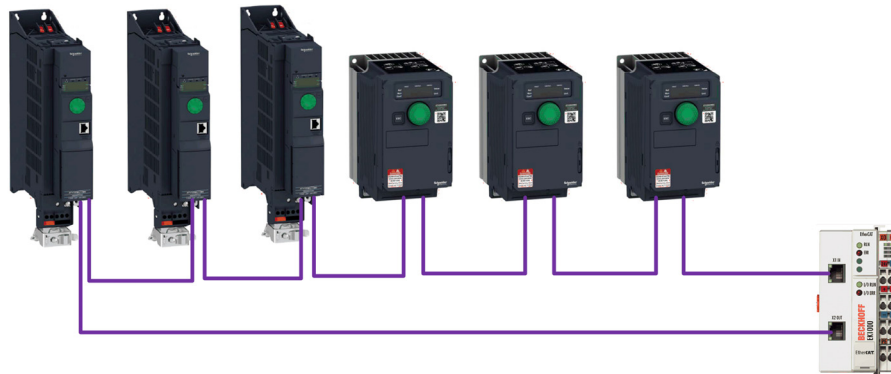

Chapter 4

Software Setup

What Is in This Chapter?

This chapter contains the following sections:

Section	Topic	Page
4.1	Basic Settings	30
4.2	Profile	33
4.3	Software Setup with TwinCAT	51
4.4	Software Setup for SoMove Ethernet over EtherCAT Connection	61

Section 4.1

Basic Settings

What Is in This Section?

This section contains the following topics:

Topic	Page
Configuring the Communication Parameters	31
[EthCat slave status] E C S S	31
[EthCat 2nd addr] E C S R	32
[EthCat addr] E C R R	32

Configuring the Communication Parameters

Overview

The parameters are described according to the graphic display terminal. These settings are also possible from commissioning software.

Access

The parameters are accessible in the **[Communication]** *C 0 1*, **[EtherCAT Module]** *E E C* - menu.

[EthCat slave status] *E C 5 5*

About This Parameter

This parameter displays the ESM status of the drive on the network.

Access

This is a read-only parameter.

The parameter number is 6690

Possible Settings

The table presents the parameter settings:

Settings	Code	Value	Description
[Init]	<i>i n i t</i>	1	Device is in Initialization state
[PreOp]	<i>P r o P</i>	2	Device is in Pre-Operational state
[Boot]	<i>b o o t</i>	3	Device is in Bootstrap state
[SafeOp]	<i>S F o P</i>	4	Device is in Safe Operational state
[Op]	<i>o P</i>	8	Device is in Operational state

[EthCat 2nd addr] E C S R**About This Parameter**

This parameter is used to select the EtherCAT second address.

Access

This is a read/write parameter.

The parameter number is 6691

Possible Settings

The table presents the parameter settings:

Settings	Code	Value	Description
[0...65535]	0...65535	0...65535	EtherCAT second address Factory setting: 0

[EthCat addr] E C R R**About This Parameter**

This parameter displays the actual EtherCAT address.

Access

This is a read-only parameter.

The parameter number is 6692

Possible Settings

The table presents the parameter settings:

Settings	Code	Value	Description
[0...65535]	0...65535	0...65535	EtherCAT actual address Factory setting: 0

Section 4.2

Profile

What Is in This Section?

This section contains the following topics:

Topic	Page
Definition of a Profile	34
Functional Profiles Supported by the Drive	35
Functional Description	36
CIA402 Operating State Diagram	37
Description of Operating States	38
Summary	40
Cmd Register <i>C P d</i>	41
Stop Commands	42
Assigning Control Word Bits	42
[CIA402 State Reg] <i>E L R</i>	43
Starting Sequence	44
Sequence for a Drive Powered by the Power Stage Supply	45
Sequence for a Drive with Separate Control Stage	46
Sequence for a Drive with Mains Contactor Control	49

Definition of a Profile

Types of Profiles

There are 3 types of profile:

- Communication profiles
- Functional profiles
- Application profiles

Communication Profile

A communication profile describes the characteristics of a bus or network:

- Cables
- Connectors
- Electrical characteristics
- Access protocol
- Addressing system
- Periodic exchange service
- Messaging service
- ...

A communication profile is unique to a type of fieldbus (such as Modbus, PROFIBUS DP, and so on) and is used by different types of devices.

Functional Profile

A functional profile describes the behavior of a type of device:

- Functions
- Parameters (such as name, format, unit, type, and so on.)
- Periodic I/O variables
- State chart
- ...

A functional profile is common to all members of a device family (such as variable speed drives, encoders, I/O modules, displays, and so on).

They can feature common or similar parts. The standardized (IEC 61800-7) functional profiles of variable speed drives are:

- CiA402
- PROFIDRIVE
- CIP AC Drive

CiA402 device profile for drives and motion control represents the next stage of this standard development and is now part of the IEC 61800-7 standard.

Application Profile

Application profile defines the services to be provided by the devices on a machine. For example, CiA DSP 417-2 V 1.01 part 2: CANopen application profile for lift control systems - virtual device definitions.

Interchangeability

The aim of communication and functional profiles is to achieve interchangeability of the devices connected via the fieldbus.

Functional Profiles Supported by the Drive

I/O Profile

Using the I/O profile simplifies PLC programming.

The I/O profile mirrors the use of the terminal strip for control by utilizing 1 bit to control a function.

The I/O profile for the drive can also be used when controlling via a fieldbus. The drive starts up as soon as the `run` command is sent. 15 bits of the control word (bits 1...15) can be assigned to a specific function.

This profile can be developed for simultaneous control of the drive via:

- The terminals
- The Modbus control word
- The fieldbus module control word

The I/O profile is supported by the drive itself and therefore in turn by all the communication ports.

CiA402 Profile

The drive only starts up following a command sequence.

The control word is standardized.

5 bits of the control word (bits 11...15) can be assigned to a function.

The CiA402 profile is supported by the drive itself and therefore by all the communication ports.

The drive supports the `velocity` mode of CiA402 profile.

In the CiA402 profile, there are two modes that are specific to the drive and characterize commands and references value management:

- Separate **[Separate] S E P**
- Not separate **[Not separ.] S , P,**

Functional Description

Introduction

Drive operation involves two main functions, which are illustrated in the diagrams below.

CiA402

The main parameters are shown with their CiA402 name and their CiA402/Drivecom index (the values in brackets are the CANopen addresses of the parameter).

The following figure shows the control diagram for drive operation:

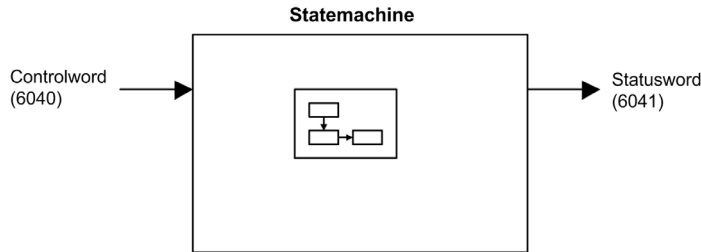

Simplified diagram for speed control in Velocity mode:

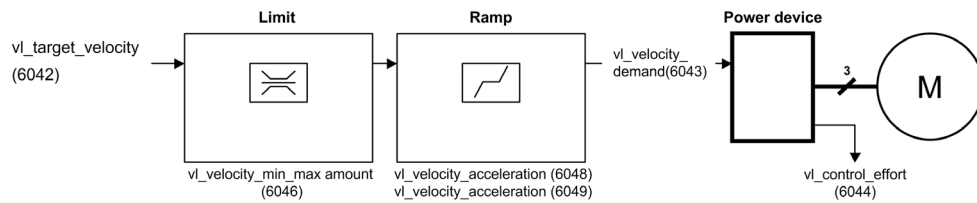

Altivar Drive

These diagrams translate as follows for the Altivar drive.

The following figure shows the control diagram for drive operation:

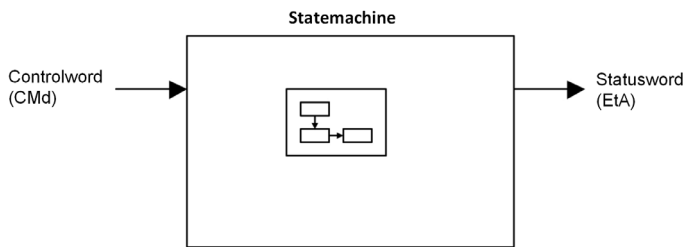

Simplified diagram for speed control in Velocity mode:

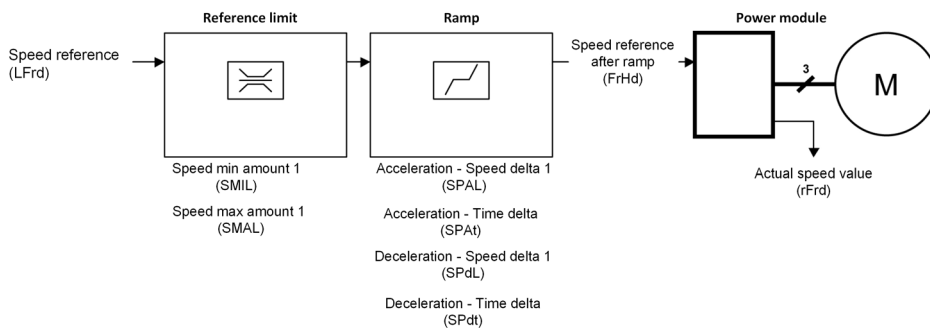

CIA402 Operating State Diagram

State Diagram

After switching on and when an operating mode is started, the product goes through a number of operating states.

The state diagram (state machine) shows the relationships between the operating states and the state transitions. The operating states are internally monitored and influenced by monitoring functions.

The following figure shows the CIA402 state diagram:

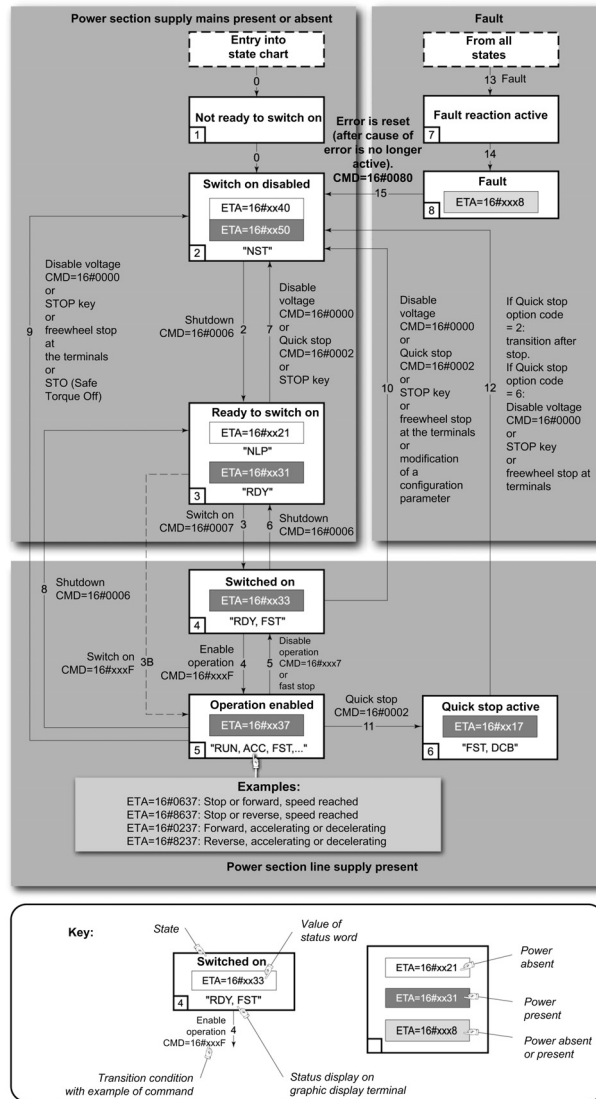

Description of Operating States

Drive Operating State

The operating state of the drive changes depending on whether the control word **[Cmd Register] C n d**, is sent or an event occurs (an error detection, for example).

The drive operating state can be identified by the value of the status word **[CIA402 State Reg] E L R**.

Operating State	Description
1 - Not ready to switch on	Initialization starts. This is a transient state invisible to the communication network.
2 - Switch on disabled	The power stage is not ready to switch on. The drive is locked, no power is supplied to the motor. For a separate control stage, it is not necessary to supply the power. For a separate control stage with mains contactor, the contactor is not closed. The configuration and adjustment parameters can be modified.
3 - Ready to switch on	The power stage is ready to switch on and awaiting power stage supply mains. For a separate control stage, it is not necessary to supply the power stage, but the system expects it in order to change to state 4 - Switched on. For a separate control stage with mains contactor, the contactor is not closed. The drive is locked, no power is supplied to the motor. The configuration and adjustment parameters can be modified.
4 - Switched on	Power stage is switched on. For a separate control stage, the power stage must be supplied. For a separate control stage with mains contactor, the contactor is closed. The drive is locked, no power is supplied to the motor. The power stage of the drive is ready to operate, but voltage has not yet been applied to the output. The adjustment parameters can be modified. If a configuration parameter is modified, the drive returns to the state 2 - Switch on disable.
5 - Operation enabled	Power stage is enabled. The drive is in running state For a separate control stage, the power stage must be supplied. For a separate control stage with mains contactor, the contactor is closed. The drive is unlocked, power is supplied to the motor. The drive functions are activated and voltage is applied to the motor terminals. If the reference value is zero or the Halt command is applied, no power is supplied to the motor and no torque is applied. To perform [Auto tuning] E u n , the drive must be in state 5 - Operation enabled. The adjustment parameters can be modified. The configuration parameters cannot be modified. NOTE: The command 4 - Enable operation must be taken into consideration only if the channel is valid. In particular, if the channel is involved in the command and the reference value, transition 4 is possible only after the reference value has been received once. The reaction of the drive to a Disable operation command depends on the value of the [SwitchOnDisable Stp] d o t d parameter: <ul style="list-style-type: none"> • If the [SwitchOnDisable Stp] d o t d parameter is set to 0, the drive changes to operating state 4 - Switched on and stops in freewheel stop. • If the [SwitchOnDisable Stp] d o t d parameter is set to 1, the drive stops on ramp and then changes to operating state 4 - Switched on.

Operating State	Description
6 - Quick stop active	<p>The drive performs a fast stop and remains locked in the operating state 6-Quick stop active. Before restarting the motor, it is required to go to the operating state 2-switch on disabled.</p> <p>During fast stop, the drive is unlocked and power is supplied to the motor. The configuration parameters cannot be modified.</p> <p>The condition for transition 12 to state 2 - Switch on disabled depends on the value of the parameter Quick stop mode (QStd):</p> <p>If the Quick stop mode parameter has the value FST2, the drive stops according to the fast stop ramp and then changes to state 2 - Switch on disabled.</p> <p>If the Quick stop mode parameter has the value FST6, the drive stops according to the fast stop ramp and then remains in state 6 - Quick stop active until:</p> <ul style="list-style-type: none"> ● A Disable voltage command is received or ● The STOP key is pressed or ● A freewheel stop command via the digital input of the terminal.
7 - Fault reaction active	Transient state during which the drive performs an action corresponding to the selected error response.
8 - Fault	Error response terminated. Power stage is disabled. The drive is locked, no power is supplied to the motor.

Summary

Device Status Summary

Operating State	Power Stage Supply for Separate Control Stage	Power Supplied to Motor	Modification of Configuration Parameters
1 - Not ready to switch on	Not required	No	Yes
2 - Switch on disabled	Not required	No	Yes
3 - Ready to switch on	Not required	No	Yes
4 - Switched on	Required	No	Yes, return to 2 - Switch on disabled operating state
5 - Operation enabled	Required	Yes	No
6 - Quick stop active	Required	Yes, during fast stop	No
7 - Fault reaction active	Depends on error response configuration	Depends on error response configuration	-
8 - Fault	Not required	No	Yes

Cmd Register [Π]

Bit Mapping of the Control Word

Bit 7	Bit 6	Bit 5	Bit 4	Bit 3	Bit 2	Bit 1	Bit 0
Fault reset	Reserved (=0)	Reserved (=0)	Reserved (=0)	Enable operation	Quick stop	Enable voltage	Switch on
0 to 1 transition = Error is reset (after cause of error is no longer active)				1 = Run command	0 = Quick stop active	Authorization to supply AC power	Mains contactor control

Bit 15	Bit 14	Bit 13	Bit 12	Bit 11	Bit 10	Bit 9	Bit 8
Manufacturer specific assignable	Manufacturer specific assignable	Manufacturer specific assignable	Manufacturer specific assignable	Manufacturer specific	Reserved (=0)	Reserved (=0)	Halt
				0 = Forward direction asked 1 = Reverse direction asked			Halt

Command	State Transition	Final Operating State	Bit 7	Bit 3	Bit 2	Bit 1	Bit 0	Example Value
			Fault Reset	Enable Operation	Quick Stop	Enable Voltage	Switch On	
Shutdown	2, 6, 8	3 - Ready to switch on	X	X	1	1	0	0006 hex
Switch on	3	4 - Switched on	X	X	1	1	1	0007 hex
Enable operation	4	5 - Operation enabled	X	1	1	1	1	000F hex
Disable operation	5	4 - Switched on	X	0	1	1	1	0007 hex
Disable voltage	7, 9, 10, 12	2 - Switch on disabled	X	X	X	0	X	0000 hex
Quick stop	11	6 - Quick stop active	X	X	0	1	X	0002 hex
	7, 10	2 - Switch on disabled						
Fault reset	15	2 - Switch on disabled	0 → 1	X	X	X	X	0080 hex
X: Value is of no significance for this command. 0→1: Command on rising edge.								

Stop Commands

Halt Command

The `Halt` command enables movement to be interrupted without having to leave the `5 - Operation enabled` state. The stop is performed in accordance with the `[Type of stop] 5 L L` parameter.

If the `Halt` command is active, no power is supplied to the motor and no torque is applied.

Regardless of the assignment of the `[Type of stop] 5 L L` parameter `[Fast stop Assign] F 5 L`, `[Ramp stop] r PP`, `[Freewheel Stop] n 5 L`, or `[DC Injection Assign] d C`, the drive remains in the `5 - Operation enabled` state.

Fast Stop Command

A `Fast Stop` command at the terminals or using a bit of the control word assigned to `Fast Stop` causes a change to the `4 - Switched on`

Freewheel Command

A `Freewheel Stop` command using a digital input of the terminal or a bit of the control word assigned to `Freewheel Stop` causes a change to operating state `2 - Switch on disabled`.

Assigning Control Word Bits

Function Codes

In the CiA402 profile, fixed assignment of a function input is possible using the following codes:

Bit	EtherCAT
Bit 11	C311
Bit 12	C312
Bit 13	C313
Bit 14	C314
Bit 15	C315

For example, to assign the DC injection braking to bit13 of a fieldbus module, simply configure the `[DC Injection Assign] d C`, parameter with the `[C313] C 3 1 3` value.

Bit 11 is assigned by default to the operating direction command `[Reverse Assign] r r 5`.

[CIA402 State Reg] E L H**Bit Mapping of the Status Word**

Bit 7	Bit 6	Bit 5	Bit 4	Bit 3	Bit 2	Bit 1	Bit 0
Warning	Switch on disabled	Quick stop	Voltage enabled	Fault	Operation enabled	Switched on	Ready to switch on
A warning is active	Power stage supply disabled	0 = Quick stop is active	Power stage supply present	Error detected	Running	Ready	1 = Awaiting power Stage supply

Bit 15	Bit 14	Bit 13	Bit 12	Bit 11	Bit 10	Bit 9	Bit 8
Manufacturer-specific Direction of rotation	Manufacturer-specific Stop via STOP key	Reserved (=0)	Reserved (=0)	Internal limit active	Target reached	Remote	Reserved (=0)
				Reference value outside limits	Reference value reached	Command or reference value via fieldbus	

Operating State	Bit 6	Bit 5	Bit 4	Bit 3	Bit 2	Bit 1	Bit 0	ETA Masked by 006F H ⁽¹⁾
	Switch On Disabled	Quick Stop	Voltage Enabled	Fault	Operation Enabled	Switched On	Ready to Switch On	
1 -Not ready to switch on	0	X	X	0	0	0	0	-
2 -Switch on disabled	1	X	X	0	0	0	0	0040 hex
3 -Ready to switch on	0	1	X	0	0	0	1	0021 hex
4 - Switched on	0	1	1	0	0	1	1	0023 hex
5 - Operation enabled	0	1	1	0	1	1	1	0027 hex
6 -Quick stop active	0	0	1	0	1	1	1	0007 hex
7 -Fault reaction active	0	X	X	1	1	1	1	002F
8 -Fault	0	X	X	1	0	0	0	0008 hex ⁽²⁾ .. .0028 hex

(1) This mask can be used by the PLC program to test the diagram state.
(2) detected error following operating state 6 - Quick stop active.
X: In this state, the value of the bit can be 0 or 1.

Starting Sequence

Description

The command sequence in the state diagram depends on how power is being supplied to the drive.

There are 3 possible scenarios:

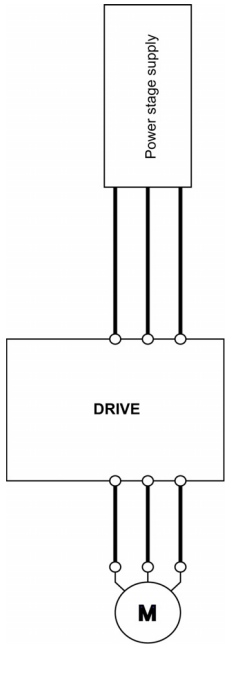
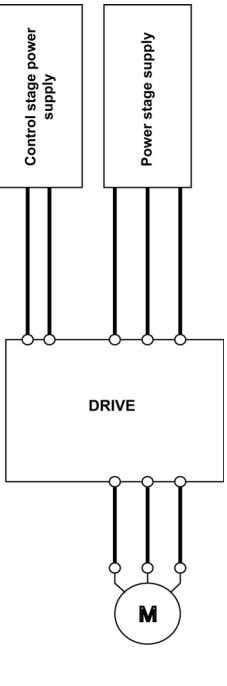
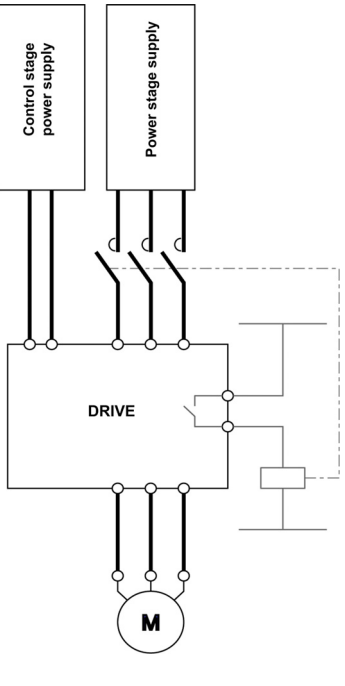
			
Power stage supply	Direct	Direct	Mains contactor controlled by the drive
Control stage supply	Not separate ⁽¹⁾	Separate	Separate
⁽¹⁾ The power stage supplies the control stage.			

Sequence for a Drive Powered by the Power Stage Supply

Description

Both the power and control stages are powered by the power stage supply.
If power is supplied to the control stage, it has to be supplied to the power stage as well.
The following sequence must be applied:

Step 1

Apply the 2 - Shut down command

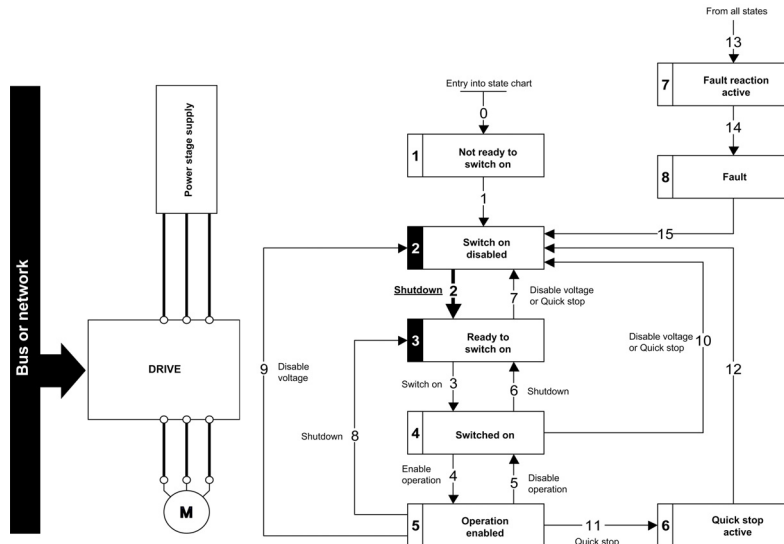

Step 2

- Check that the drive is in the operating state 3 - Ready to switch on.
- Then apply the 4 - Enable operation command.
- The motor can be controlled (send a reference value not equal to zero).

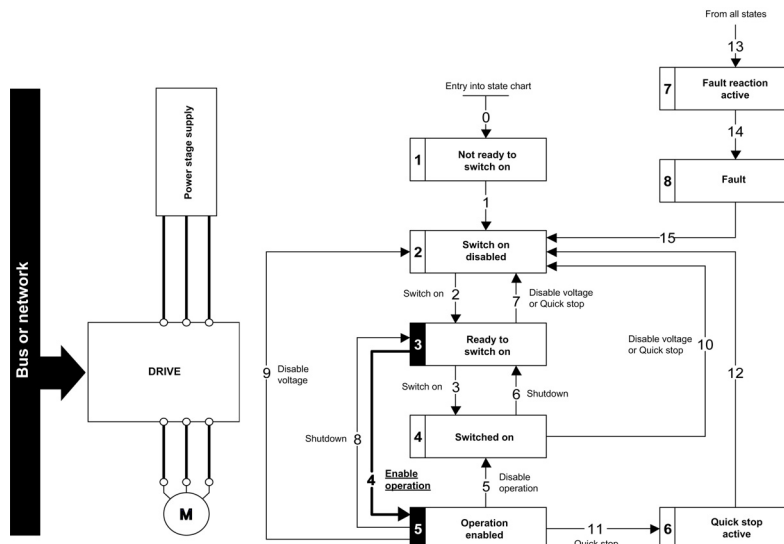

NOTE: It is possible, but not necessary to apply the 3 - Switch on command followed by the 4 - Enable Operation command to switch successively into the operating states 3 - Ready to Switch on, 4 - Switched on and then 5 - Operation Enabled. The 4 - Enable operation command is sufficient.

Sequence for a Drive with Separate Control Stage

Description

Power is supplied separately to the power and control stages.

If power is supplied to the control stage, it does not have to be supplied to the power stage as well.

The following sequence must be applied:

Step 1

- The power stage supply is not necessarily present.
- Apply the 2 - Shut down command

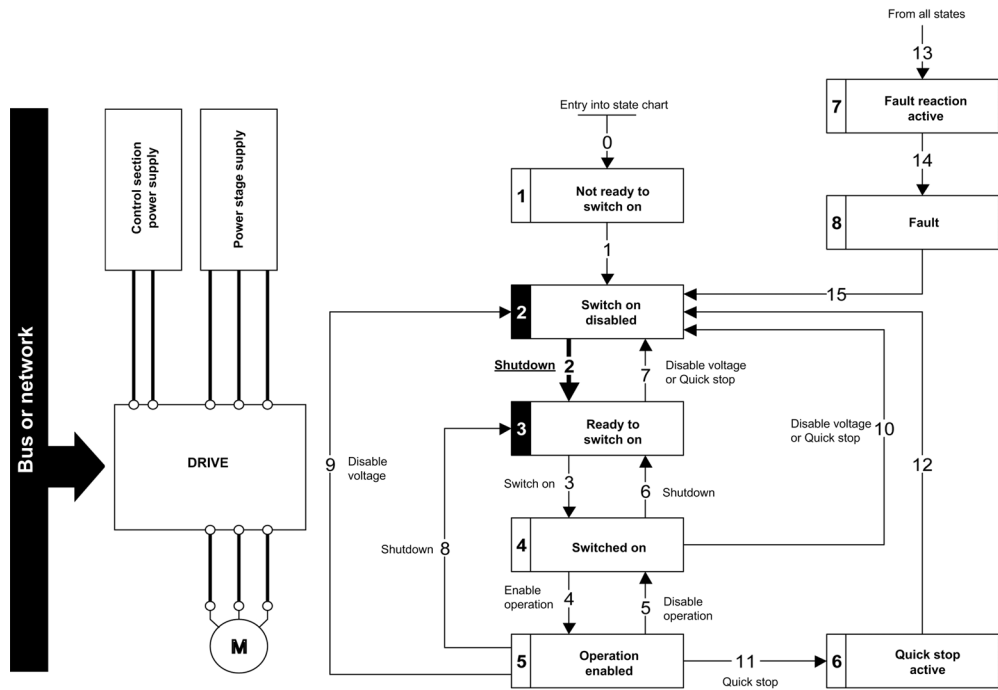

Step 2

- Check that the drive is in the operating state 3 - Ready to switch on.
- Check that the power stage supply is present (Voltage enabled of the status word).

Power Stage Supply	Terminal Display	Status Word
Absent	<i>n L P</i>	21 hex
Present	<i>r d Y</i>	31 hex

- Apply the 3 - Switch on command

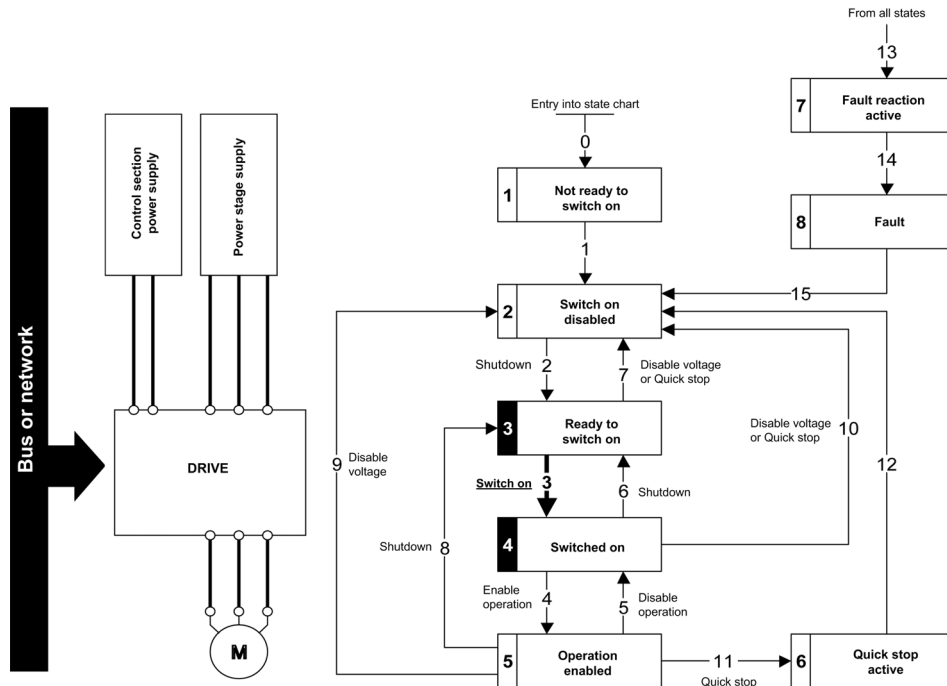

Step 3

- Check that the drive is in the operating state 4 - Switched on.
- Then apply the 4 - Enable operation command.
- The motor can be controlled (send a reference value not equal to zero).
- If the power stage supply is still not present in the operating state 4 - Switched on after a time delay [Mains V. time out] L C E, the drive triggers an error [Input Contactor] L C F.

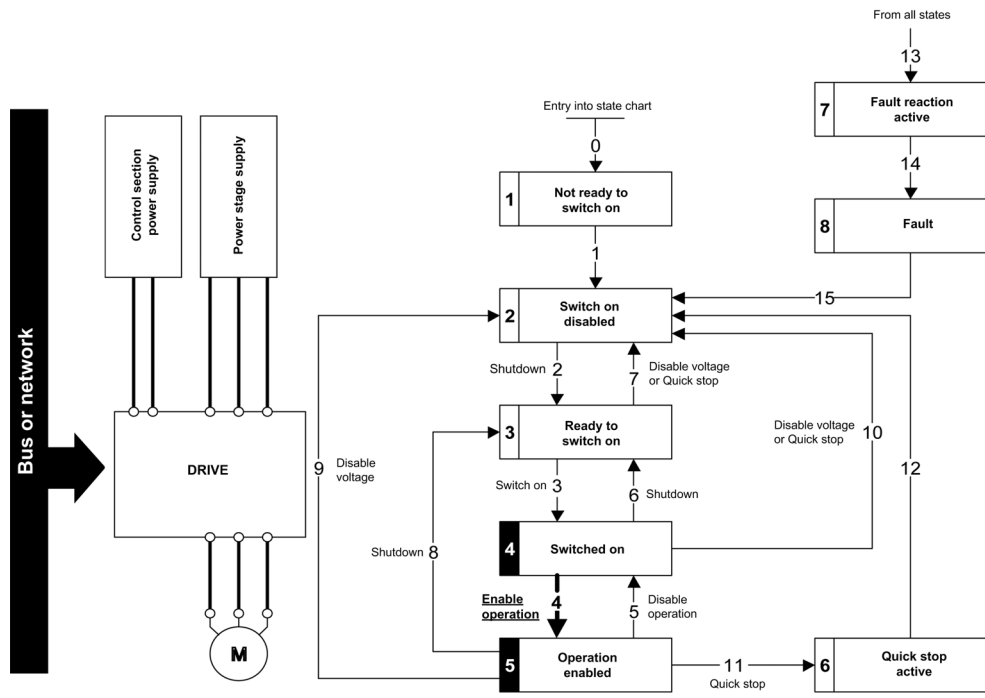

Sequence for a Drive with Mains Contactor Control

Description

Power is supplied separately to the power and control stages.

If power is supplied to the control stage, it does not have to be supplied to the power stage as well. The drive controls the mains contactor.

The following sequence must be applied:

Step 1

- The power stage supply is not present as the mains contactor is not being controlled.
- Apply the 2 - `Shutdown` command.

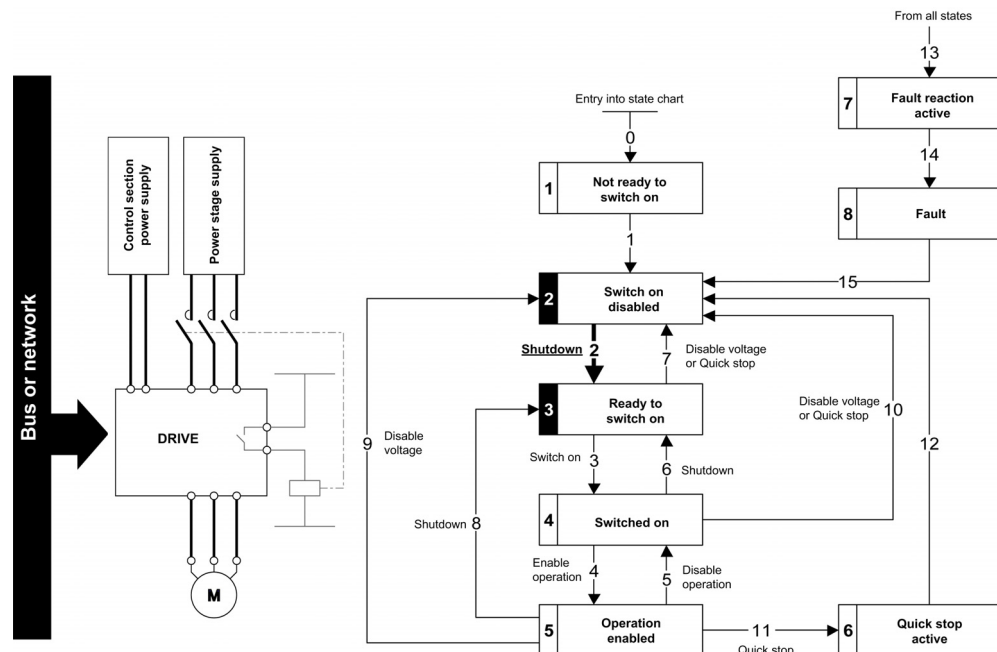

Step 2

- Check that the drive is in the operating state 3 - Ready to switch on.
- Apply the 3 - Switch on command, which closes the mains contactor and switch on the power stage supply.

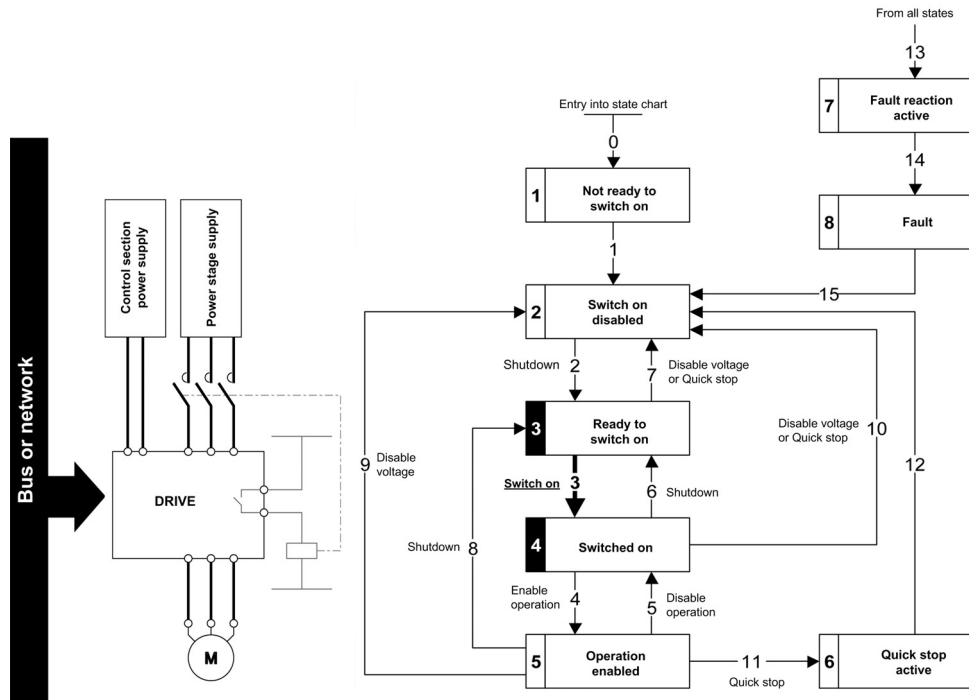

Section 4.3

Software Setup with TwinCAT

What Is in This Section?

This section contains the following topics:

Topic	Page
Introduction	52
TwinCAT® Configuration	53

Introduction

Overview

Here is an example of an application that shows how to configure a PLC equipped with an EtherCAT port using theTwinCAT® software copyright BECKHOFF. This example has been done with TwinCAT® software version 2.11.

NOTE: The screenshots or procedure in this example can change with a newer TwinCAT® software version. The ESI file must be integrated in to the system of the master controller.

Drive Configuration

The drive need to be configured for operation with CiA402 Profile in combined mode, for details, refer to Configuration of the Drive for Operation with CiA402 Profile in Combined Mode ([see page 78](#)).

TwinCAT® Configuration

System Manager

Start TwinCAT® system-manager® and set show Real-Time Ethernet compatible devices in order to install the Ethernet adapters.

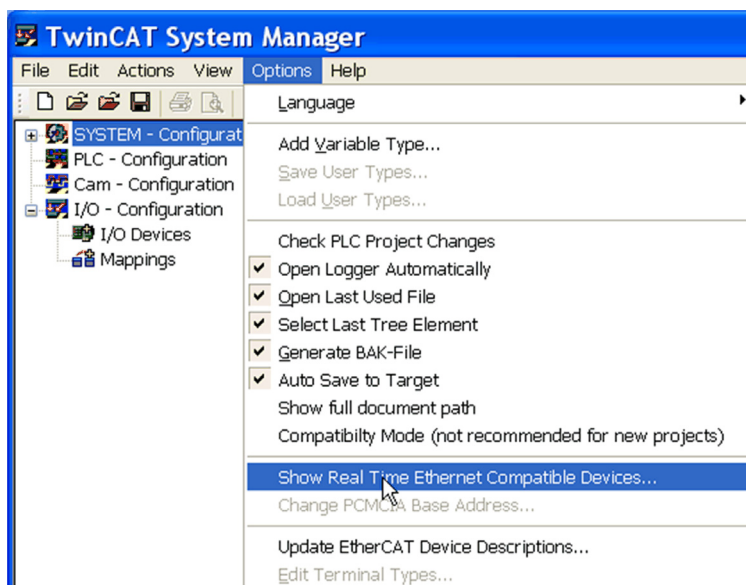

1. Select your computer Ethernet board and click **Install**
2. Once the installation is finished, click **Enable** to enable the Ethernet board.

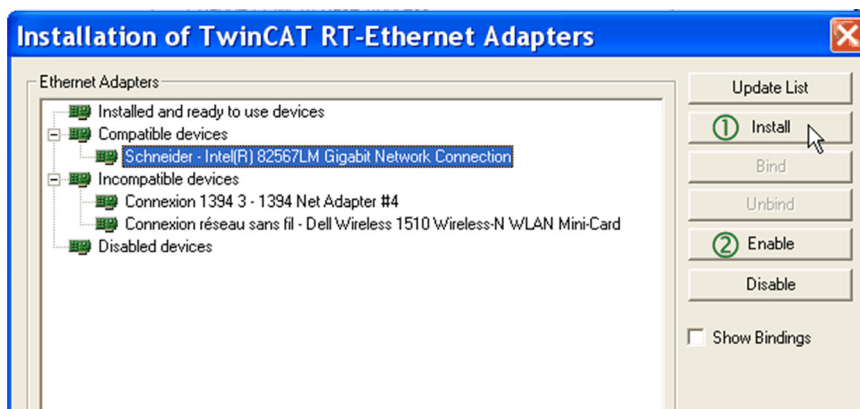

Add Master

In this example, a computer is used to run TwinCAT® and PLC runtime as Master.

To add the master

1. Click the **Choose Target** button
2. In the **Choose Target System** dialog box, select the target and click the **Search (Ethernet)** button.

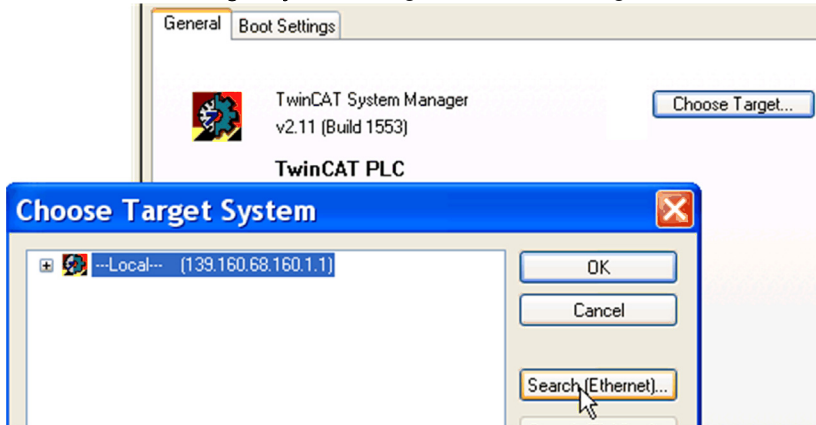

3. In the **Add Route** dialog box, click the **Broadcast Search** button and select the master (your computer in this example) listed under **Host name** column.

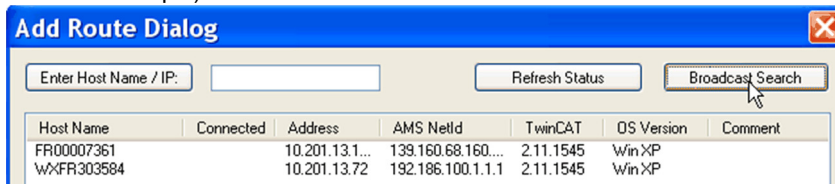

4. Make sure that you are in **Config Mode**

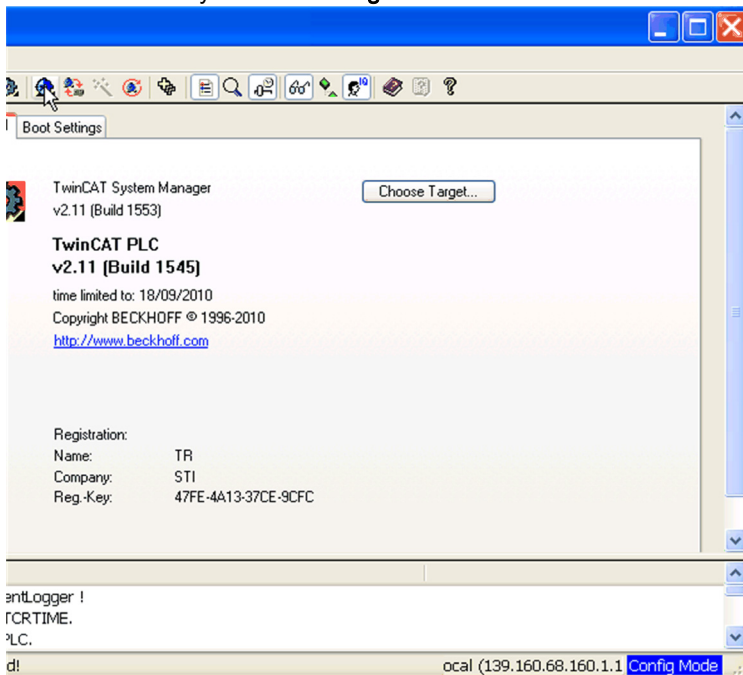

Add the Drive

Make sure that the drive is connected to the Ethernet board of your computer.
To add the drive, you need to scan the boxes and activate free run.

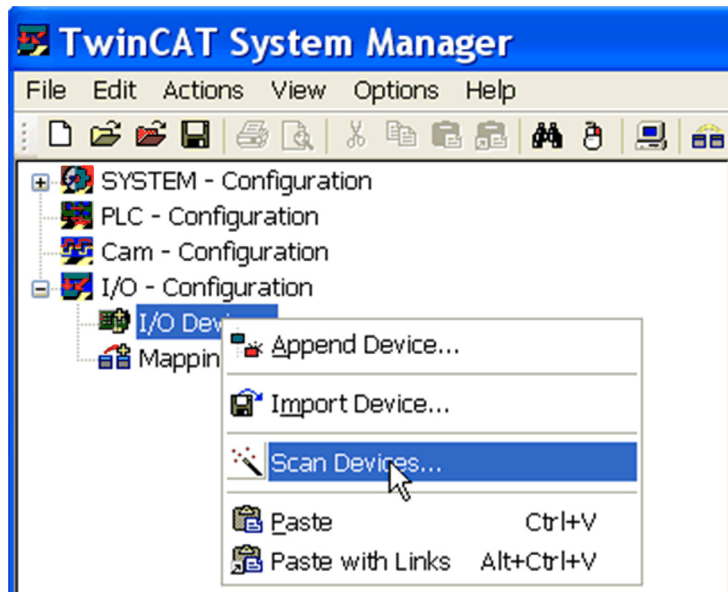

The drive is added.

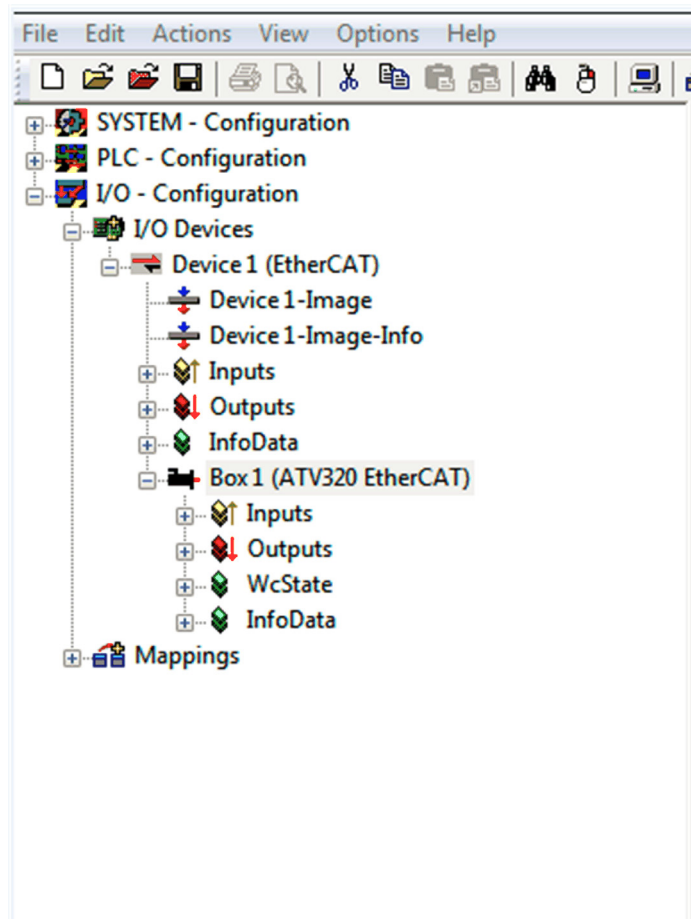

PLC - Control Initialization

1. Launch TwinCAT PLC control® software
2. Select **File** → **New**
3. In the **Choose Target System Type**, select the system you wish to use.
4. Click **Ok**

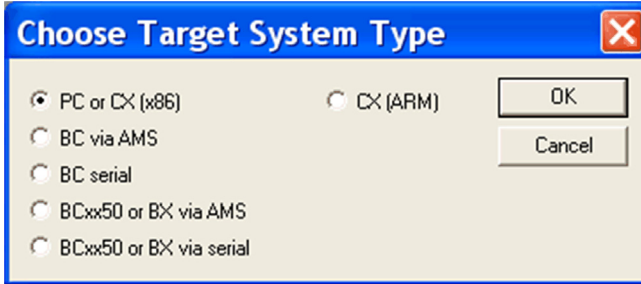

5. In the **New POU** dialog box, under **Language of the POU**, select the programming language (in this case ST (structured language) is selected).

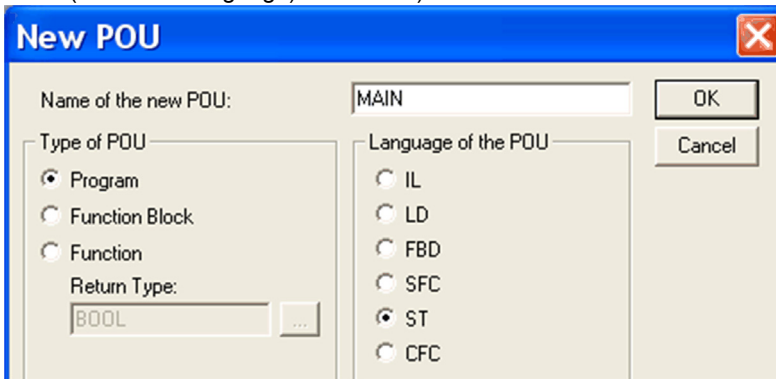

Declare Variables

1. Select Global_Variables

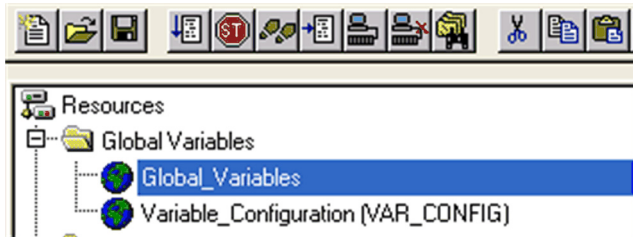

2. Create the Master Global Variables for the drive as below:

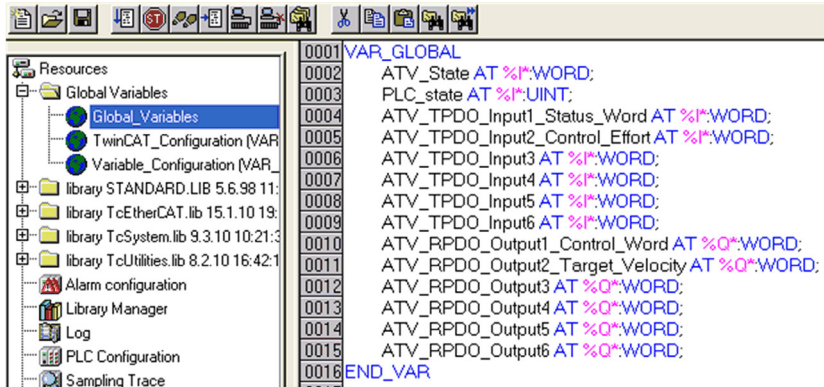

NOTE:

- RPDO (Receive PDO), containing 6 input words of the communication scanner OCA1 to OCA6.
- TPDO (Transmit PDO), containing 6 output words of the communication scanner OMA1 to OMA6.

3. Add 1 instruction minimum in POU's before rebuild.

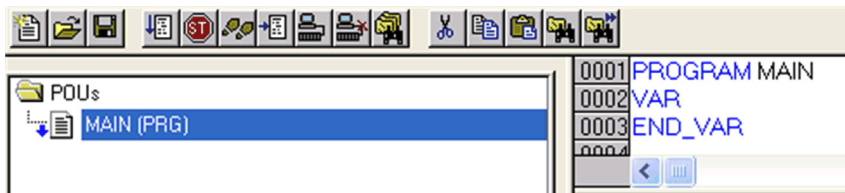

4. Check the compilation result without error; this action creates files in: *C:\TwinCAT\Plc*, for example create *ATV_PL.C.tpy*

System Manager - Append PLC Project

In the System Manager software, realize the link between the Master and the slave. Creation of the links between **PLC - Configuration** and **I/O - Configuration** need to be created.

Select **Append PLC Project** as seen in the figure.

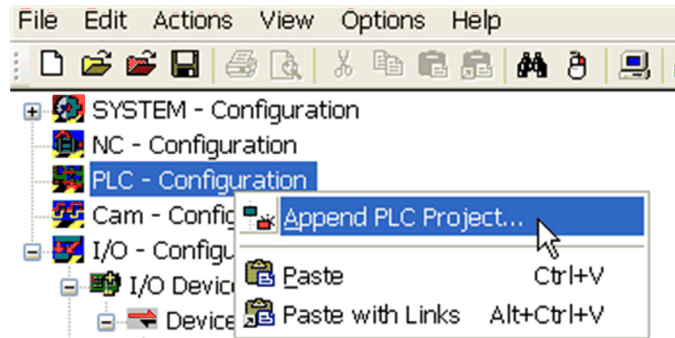

As example, select: *C:\TwinCAT\Plc\ATV_PLC.tpy*

For each parameter, create the link with the ATV I/O listing

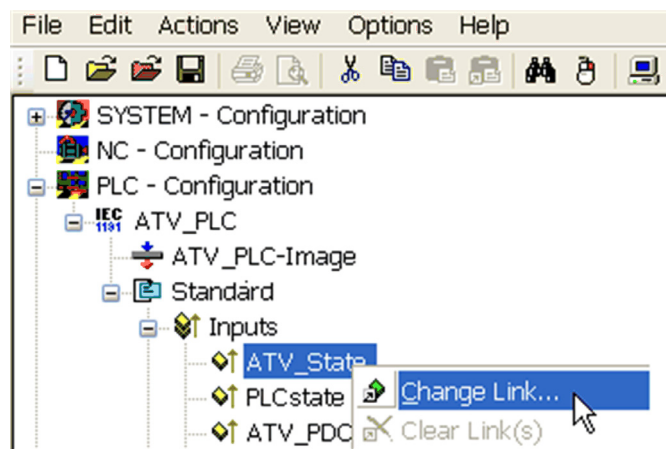

Example for **ATV_State**

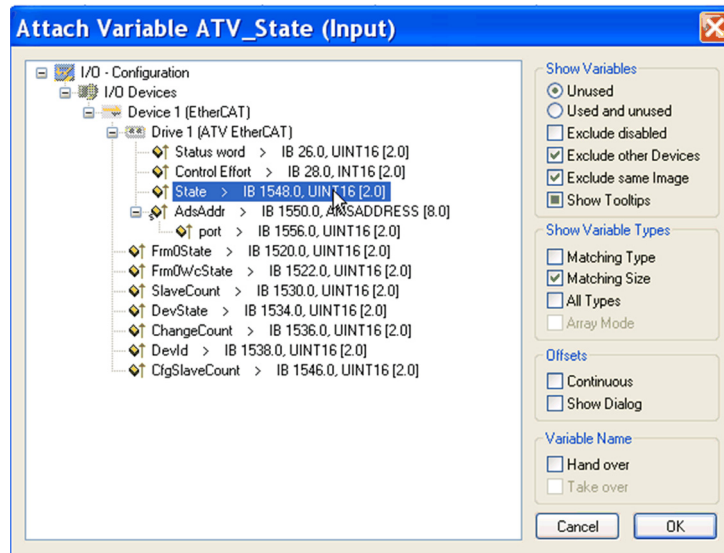

PLC - Control: New Compilation

Select **Project** → **Rebuild All**

This action updates the information.

System Manager: Activate Configuration

Select **Actions** → **Activate configurations**

PLC - Control: New Compilation

Select **Online** → **login**



Select **Online** → **Run**

The PLC and the EtherCAT fieldbus are now running

In TwinCAT® PLC Control, you see the list of the variables and values:

0001	ATV_State (%IB12) = 16#0008
0002	PLC_state (%IB16) = 16#0000
0003	ATV_TPDO_Input1_Status_Word (%IB18) = 16#0250
0004	ATV_TPDO_Input2_Control_Effort (%IB20) = 16#0000
0005	ATV_TPDO_Input3 (%IB22) = 16#0000
0006	ATV_TPDO_Input4 (%IB24) = 16#0000
0007	ATV_TPDO_Input5 (%IB26) = 16#0000
0008	ATV_TPDO_Input6 (%IB28) = 16#0000
0009	ATV_RPDO_Output1_Control_Word (%QB0) = 16#0002
0010	ATV_RPDO_Output2_Target_Velocity (%QB2) = 16#0000
0011	ATV_RPDO_Output3 (%QB4) = 16#0000
0012	ATV_RPDO_Output4 (%QB6) = 16#0000
0013	ATV_RPDO_Output5 (%QB8) = 16#0000
0014	ATV_RPDO_Output6 (%QB10) = 16#0000
0015	SystemInfo (%MB32768)
0016	SystemTaskInfoArr (%MB32832)

PLC - Control: Start and Stop the Motor

Example to start the motor:

- The drive is on `switch on disabled` operating state and displays **[Freewheel stop]** *n 5 t*
Set `ATV_RPDO_Output1_Control_Word (%QB0) = 0006` hex
- The drive is on `ready to switch on` operating state and displays **[Ready]** *r d y*
Set `ATV_RPDO_Output1_Control_Word (%QB0) = 000F` hex
- The drive is on `operational Enable` operating state
Set `ATV_RPDO_Output2_Target_Velocity (%QB2) = 05DC` hex
- The Motor starts
Set `ATV_RPDO_Output1_Control_Word (%QB0) = 0000` hex
- The motor stops and drive go back on `switch on disabled` operating state with **[Freewheel stop]** *n 5 t* displayed

PLC - Control: Add a Library for Other Services

Install the library: TcEtherCAT.lib

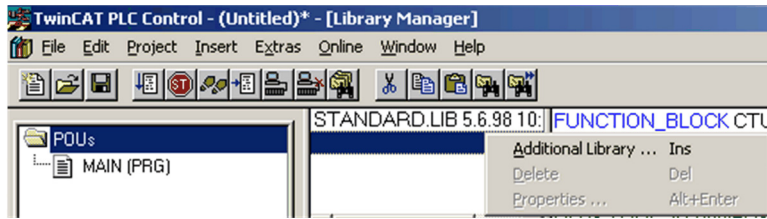

Example for exchanges with SDO

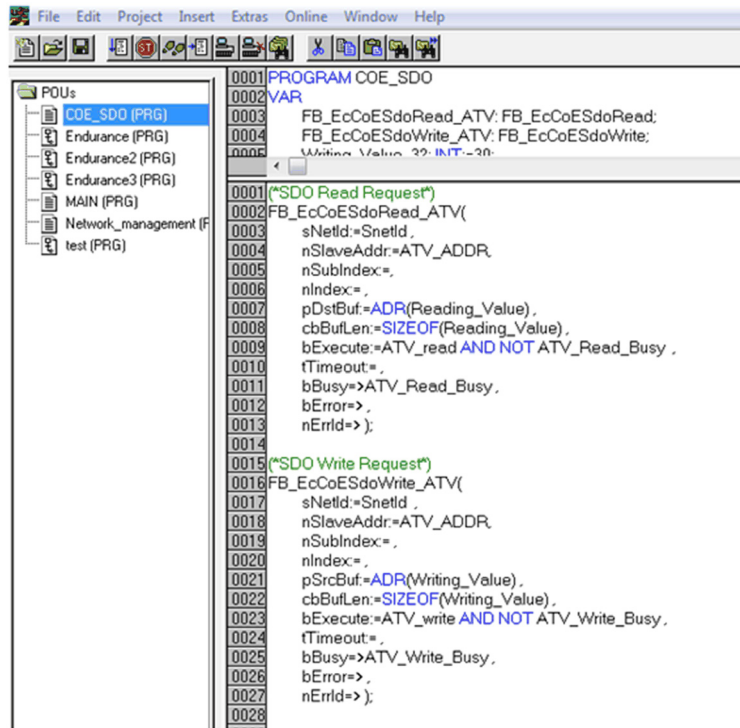

Example for exchanges with ESM states

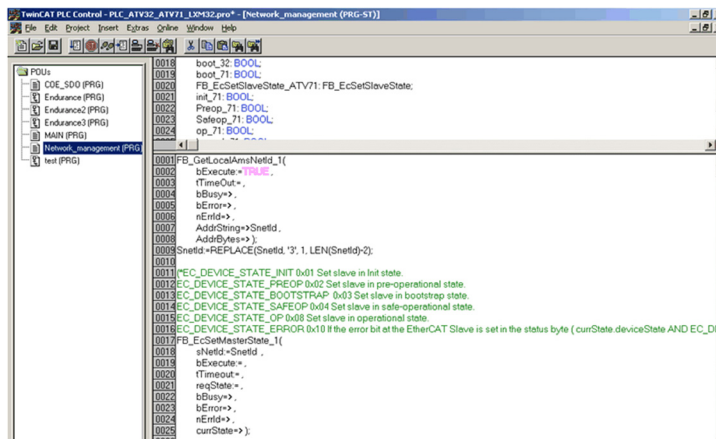

Section 4.4

Software Setup for SoMove Ethernet over EtherCAT Connection

What Is in This Section?

This section contains the following topics:

Topic	Page
Introduction	62
Ethernet Configuration	63
EtherCAT Configuration	64
PLC Configuration	67
SoMove Connection Through EoE	71

Introduction

Overview

Here is an example of how to configure a PLC equipped with an EtherCAT port using the TwinCAT® software to establish a SoMove connection through the Ethernet over EtherCAT(EoE) service.

NOTE: The screenshots or procedure in this example can change with a newer TwinCAT® software version.

Networks and Devices Overview

The following figure shows the elements involved in this procedure:

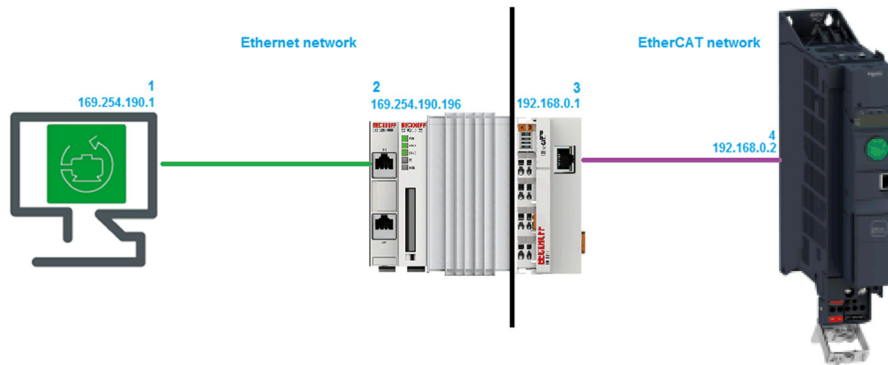

- 1 PC with SoMove and associated drive DTM.
- 2 CX1020 CPU module
- 3 EK1110 EtherCAT module
- 4 ATV320 equipped with VW3A3601 EtherCAT module.

ModbusTCP is used on the Ethernet network part then Ethernet over EtherCAT (EoE) service is used on the EtherCAT network to transmit data between the drive and SoMove.

Ethernet Configuration

PC Ethernet Configuration

Go to the PC network adapter properties and configure an IP address.

For example, use the following settings:

1. IP address: 169.254.190.1
2. Subnet mask: 255.255.255.0

PLC Ethernet Configuration

- On TwinCAT System Manager, click **SYSTEM-Configuration** then click the **CX Settings** tab.
- On the **CX Settings** tab, do the following settings:
 - a. Click **Fixed IP address**
 - b. In the **IP Address** box, enter 169.254.190.196
 - c. In the **Subnet mask** box, enter 255.255.255.0

NOTE: Other settings have no effects for this procedure.

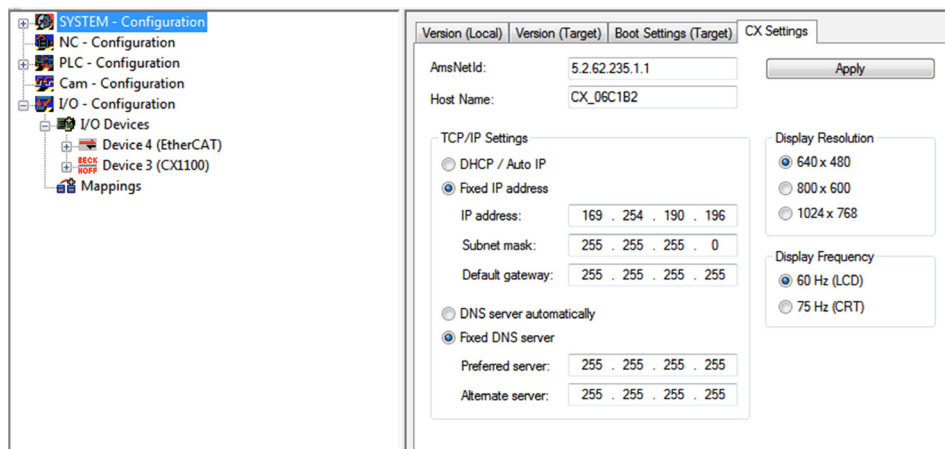

EtherCAT Configuration

Verification of EtherCAT Module IP Address

- On TwinCAT System Manager, click on the EtherCAT Module and check the IP address and mask on the Adapter tab, on the **IP Address** field, are the same as the one defined on Master IP Configuration part.

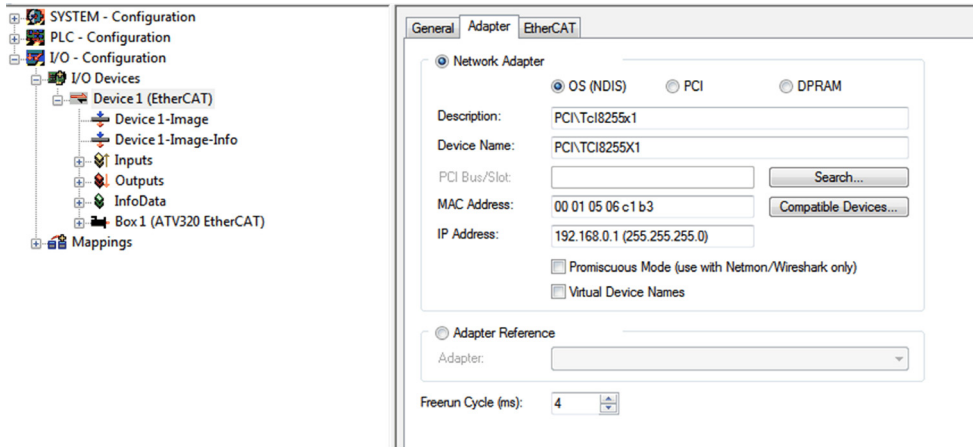

- On the **EtherCAT** tab, click the **Advanced Settings** button.
- On **EoE Support** part:
 - Select the **Enable** checkbox to activate the Virtual Ethernet Switch
 - Select the **Connect to TCP/IP Stack** checkbox
 - Click **OK** to validate the configuration

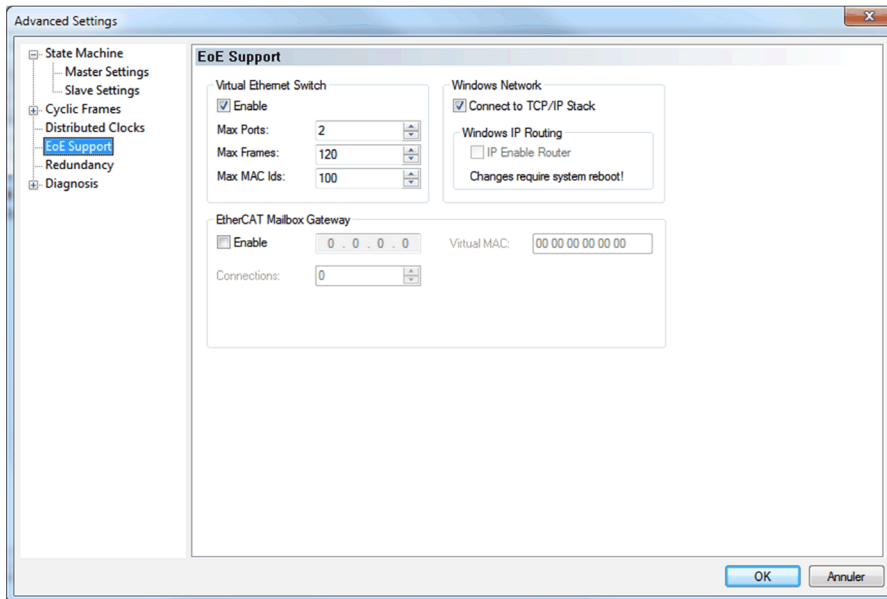

Add the Device

Make sure that the drive is connected to the EtherCAT board of the PLC.
To add the drive, you need to scan the boxes and activate free run.

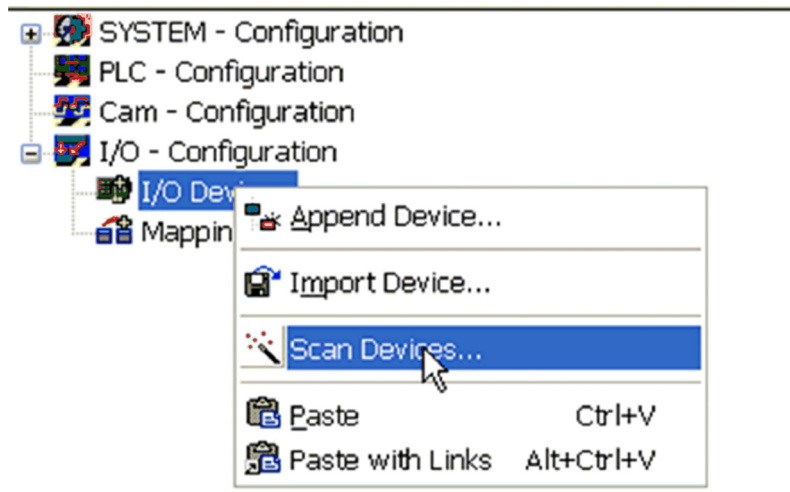

The drive is added

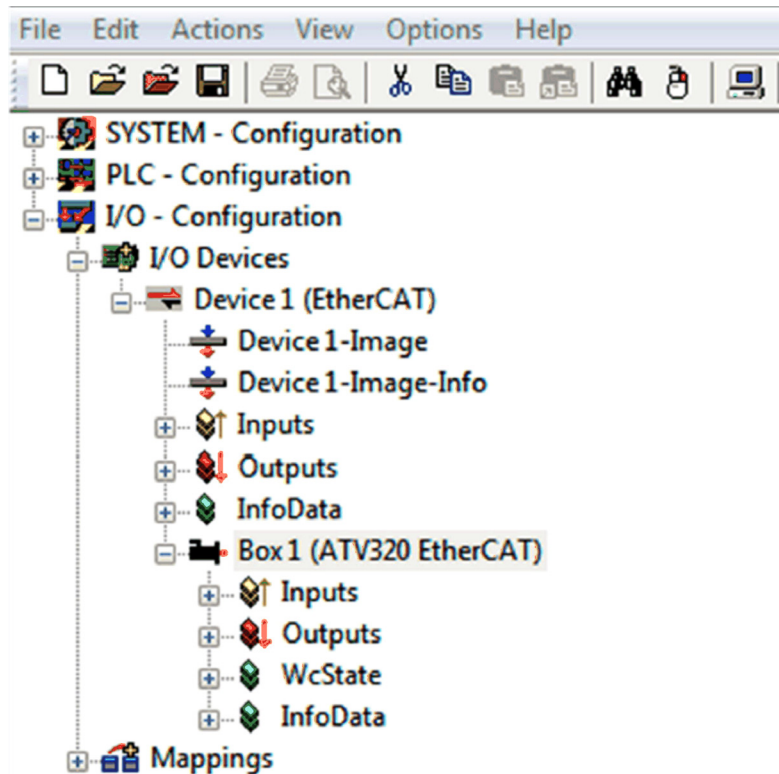

Configuration of ATV320 IP Address

- On TwinCAT System Manager, click on the box corresponding to the drive, go to **EtherCAT** tab and click the **Advance Settings** button.
- On the opened window, on **Mailbox** part, check and adjust the size of the mailbox if needed by entering a greater value on **Out Size (hex)** field. The recommend value of the mailbox size for SoMove connection is 336 bytes (150 hex).

NOTE: Adjustment of the mailbox size impacts the performances of the EtherCAT network.

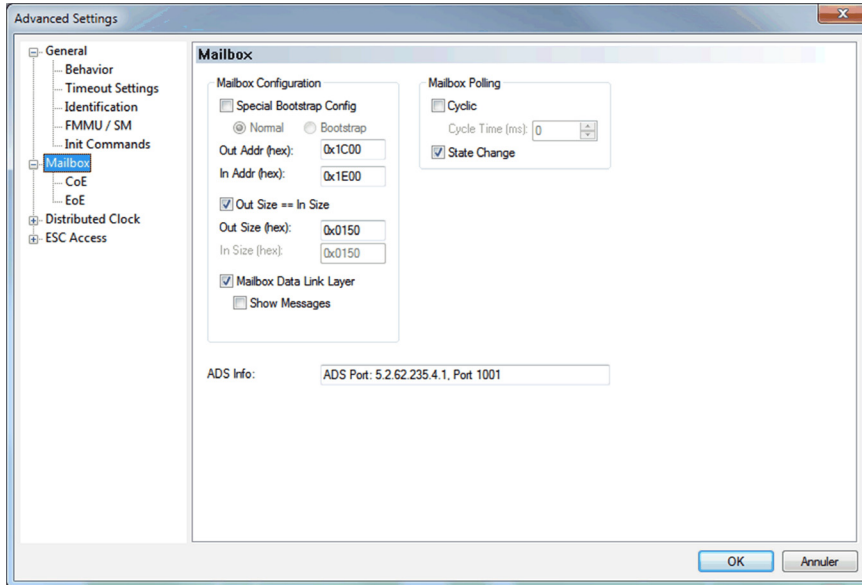

- On EoE part, configure the following parameters:
 - a. In the **IP Address** box, enter 192.168.0.2
 - b. In the **Subnet Mask** box, enter 255.255.255.0
 - c. In the **Default Gateway** box, enter 192.168.0.1

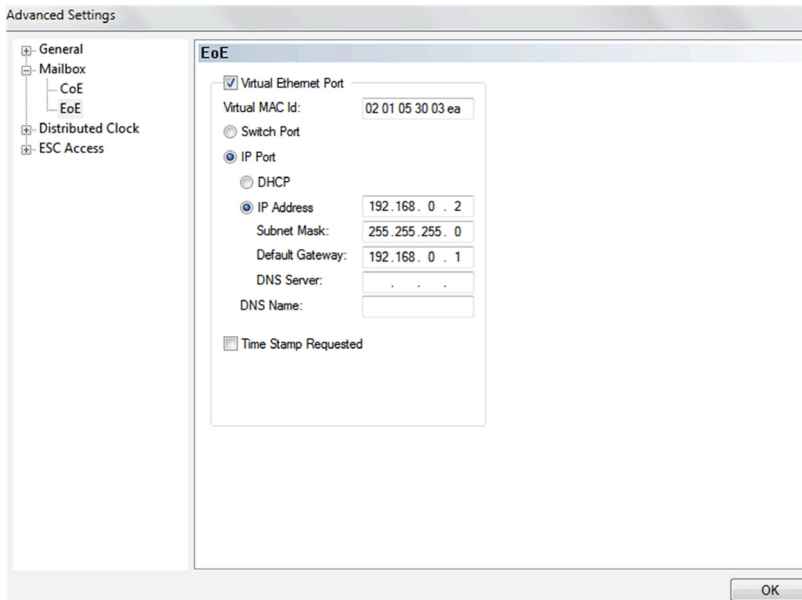

PLC Configuration

Remote Connection to the PLC

- Using the **CerHost** software, connect to the PLC by entering the IP address or the host name of the PLC.
 - On the **File** menu, click **Connect**
 - Enter the host name or IP address and click **OK** to connect to the PLC
- NOTE:** Password is not required

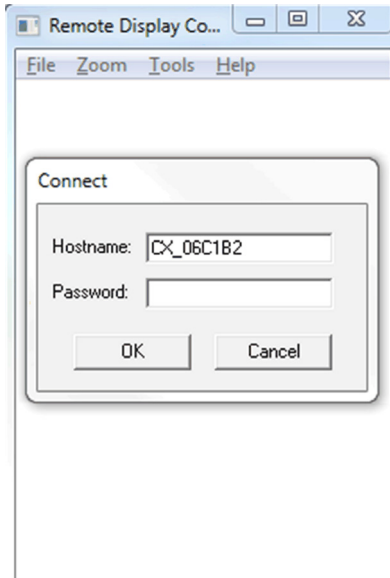

Master IP Configuration

- Once connected, click the **Start** button and then click **Control Panel**.

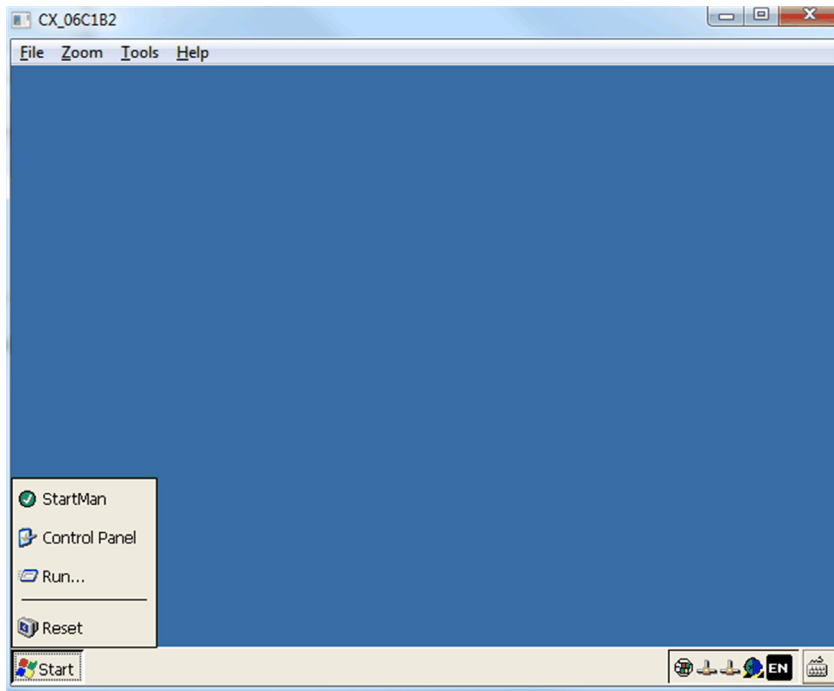

- On the opened window, double-click **Network and Dial-up Connections**:

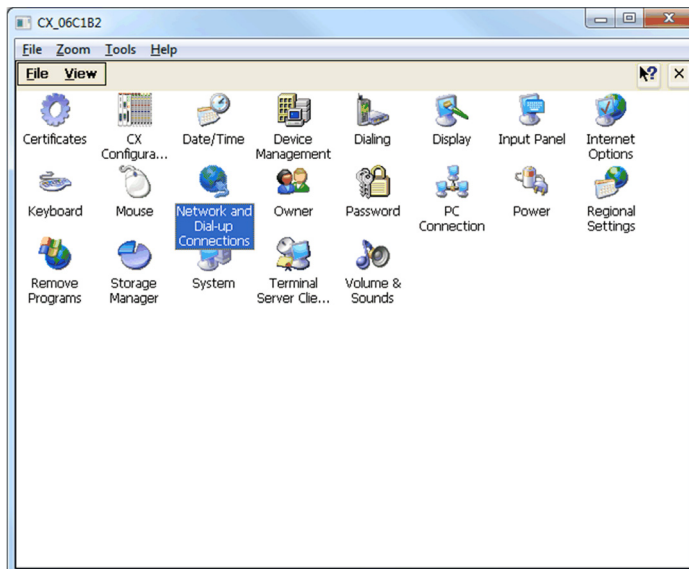

- On the opened window, double-click **PCI-TCI8255X1** connection and enter the following configuration:
 - Click **Specify an IP address**.
 - In the **IP Address** box, enter 192.168.0.1
 - In the **Subnet Mask** box, enter 255.255.255.0

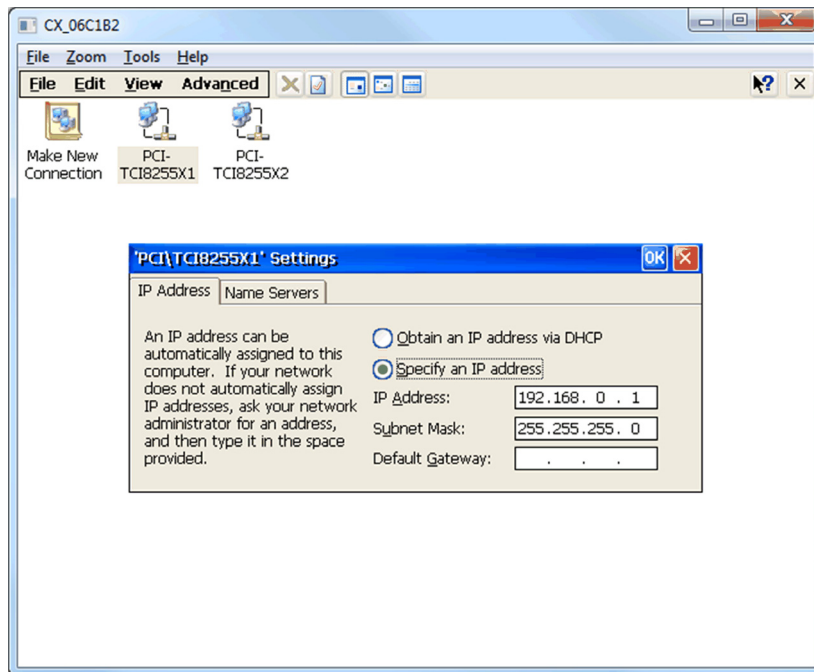

- Click **OK** and close the **Network and Dial-up Connections** window

Routing Configuration

- Double-click **CX Configuration**.
- On the opened window, click the **Miscellaneous** tab and then select the **IP Routing** check box.

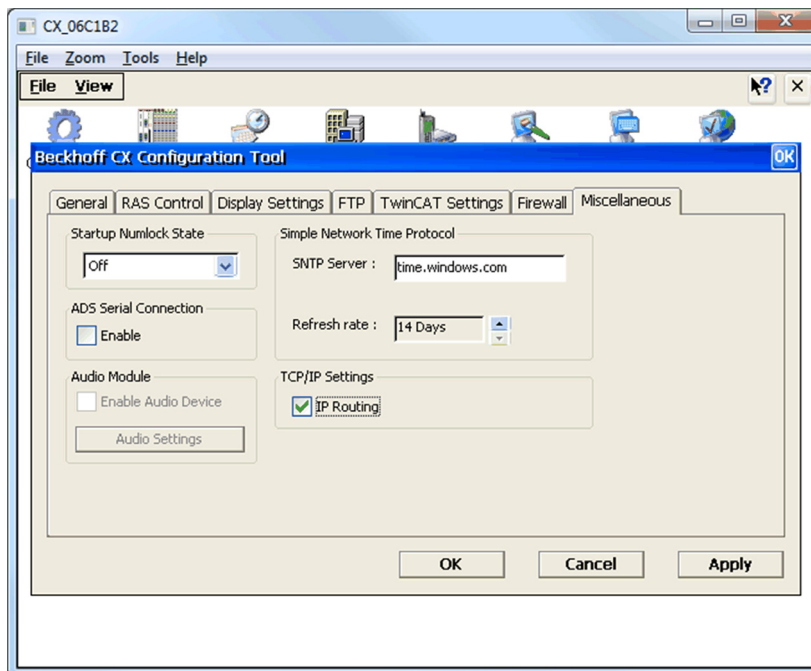

- Click **Apply**, the following message is displayed.

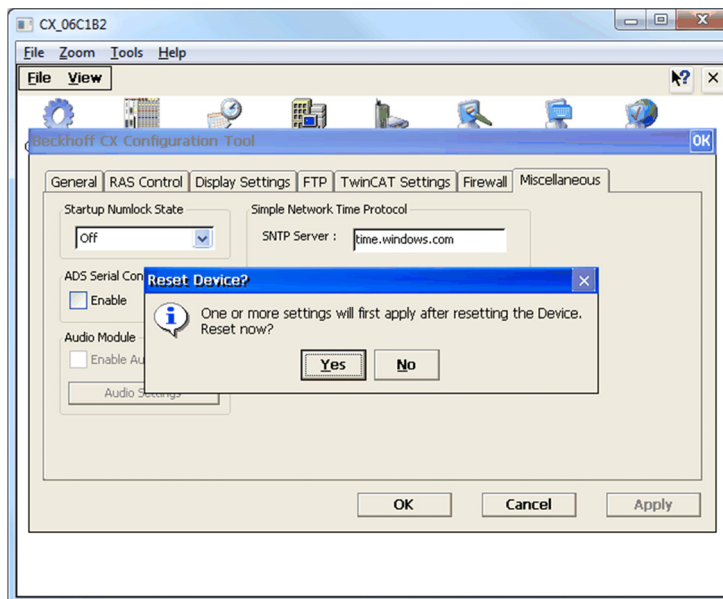

- Click **Yes**, the PLC restarts automatically.
- Close the **CerHost** software.

SoMove Connection Through EoE

Routing on PC

To allow SoMove connection, it is needed to establish a route between the PC network (169.254.190.xxx) to the fieldbus network (192.168.0.xxx) through the PLC at network address 169.254.190.196.

- Open the windows command prompt and type the following command:
route add 192.168.0.0 mask 255.255.255.0 169.254.190.196
- Then validate by Pressing **Enter** key.
Ok should be displayed

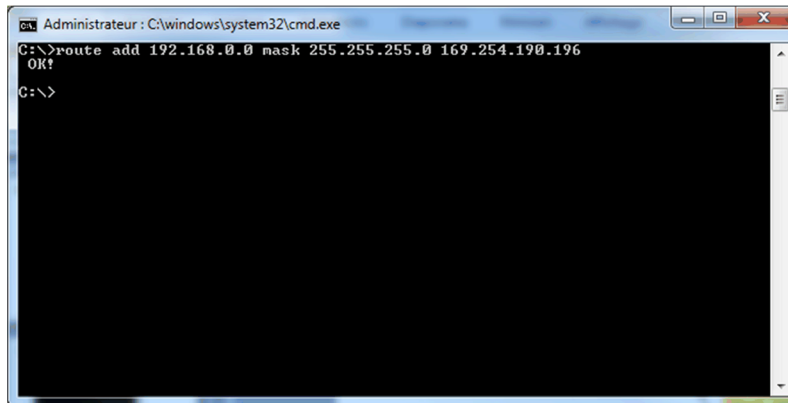

```
Administrateur : C:\windows\system32\cmd.exe
C:\>route add 192.168.0.0 mask 255.255.255.0 169.254.190.196
OK!
C:\>
```

NOTE: With this command, the route is lost at each PC restart. If you want to save this route, you should have the **-p** flag added as below:

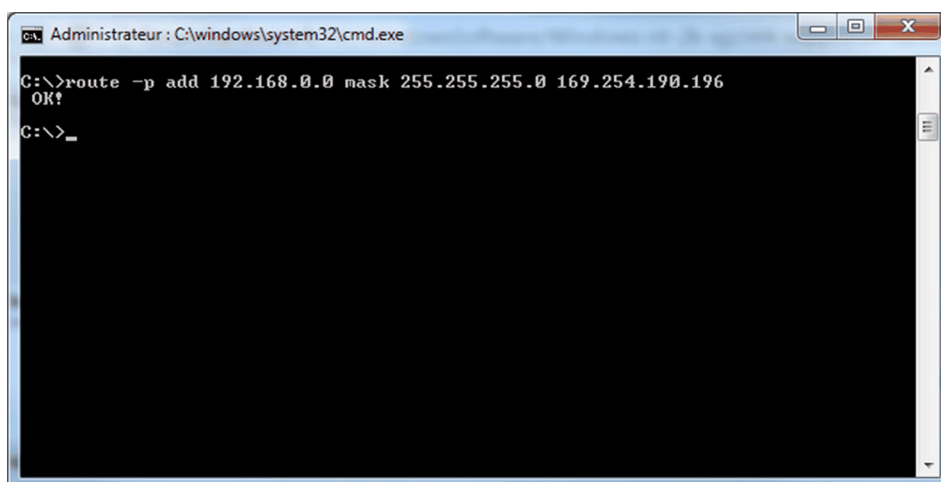

```
Administrateur : C:\windows\system32\cmd.exe
C:\>route -p add 192.168.0.0 mask 255.255.255.0 169.254.190.196
OK!
C:\>_
```

To remove a saved route, type the following command: **route delete 192.168.0.0**

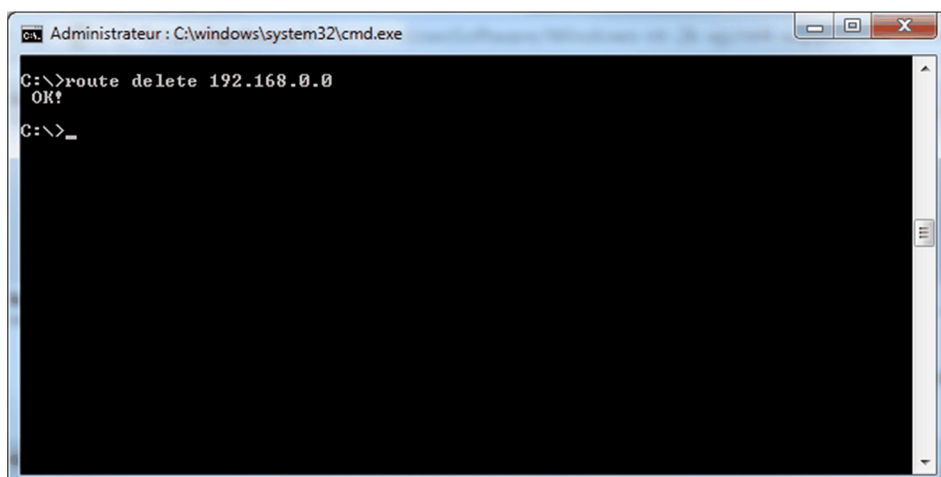

```
Administrateur : C:\windows\system32\cmd.exe
C:\>route delete 192.168.0.0
OK!
C:\>_
```

SoMove Configuration and Connection

As the route is established, it is now possible to connect to the drive using SoMove.

- Start SoMove
- Click the **Edit Connection/Scan** button
- On the **Scan Result** window, click **Modbus TCP** and then click the **Advanced Settings** button
- On the **Advanced Settings** window, Click the **Scan** tab and enter the following data
 - a. Target Network: 192.168.0.0
 - b. Scan configuration: Single with address 2

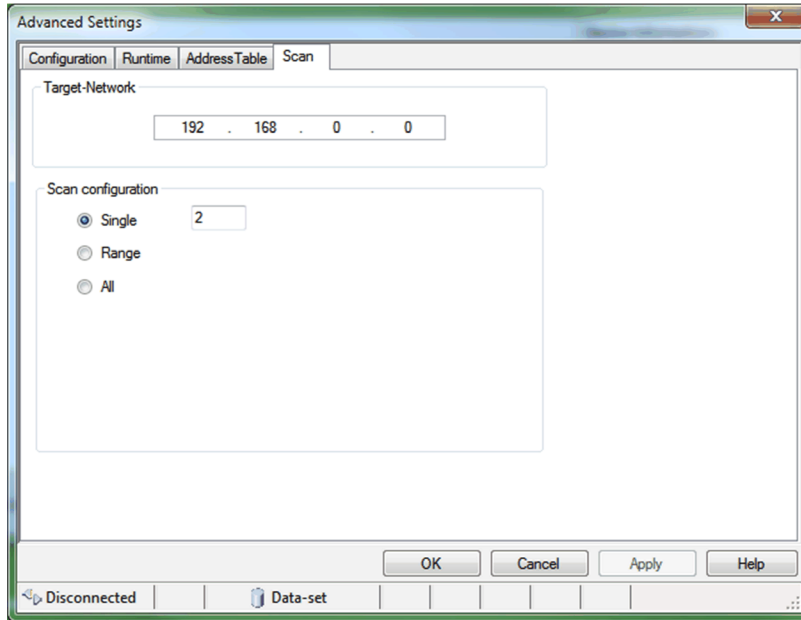

- Click **OK** and then click the **Scan Network** button
- Device is discovered.
- Select the device and click on Connect button

Chapter 5

Operation

What Is in This Chapter?

This chapter contains the following sections:

Section	Topic	Page
5.1	Operating States	74
5.2	Operating Modes	75

Section 5.1 Operating States

Configuring Communication Error Response

Description

The response of the drive in the event of communication interruption can be configured. Configuration can be performed using the display terminal from the **[FAULT MANAGEMENT] F L E -** menu, **[COM. FAULT MANAGEMENT] C L L -** via the **[Fieldbus Interrupt Resp] C L L** parameter.

The values of the parameter **[Fieldbus Interrupt Resp] C L L**, which triggers a transition to the operating state faults are:

Value	Meaning
[Freewheel Stop] 4 E 5	Freewheel stop (factory setting)
[Ramp stop] r P P	Stop on ramp
[Fast stop] F 5 E	Fast stop
[DC injection] d C I	DC injection stop

The values of the parameter **[Fieldbus Interrupt Resp] C L L**, which does not trigger a transition to the operating state faults are:

Value	Meaning
[Ignore] n o	Detected error ignored
[Per STT] 5 E E	Stop according to configuration of [Type of stop] 5 E E
[Fallback Speed] L F F	Change to fallback speed, maintained as long as the detected error persists and the run command has not been removed
[Speed maintained] r L 5	The drive maintains the speed at the time the detected error occurred, as long as the detected error persists, and the run command has not been removed

The fallback speed can be configured in the **[FAULT MANAGEMENT] F L E -**, **[FALLBACK SPEED] L F F -** submenu, using the **[FallbackSpeed] L F F**, using the **[FallbackSpeed] L F F** parameter.

WARNING

LOSS OF CONTROL

If this parameter is set to **n o**, fieldbus communication monitoring is disabled.

- Only use this setting after a thorough risk assessment in compliance with all regulations and standards that apply to the device and to the application.
- Only use this setting for tests during commissioning.
- Verify that communication monitoring has been re-enabled before completing the commissioning procedure and performing the final commissioning test.

Failure to follow these instructions can result in death, serious injury, or equipment damage.

Section 5.2

Operating Modes

What Is in This Section?

This section contains the following topics:

Topic	Page
Configuring the Control Channel	76
Configuration of the Drive for Operation in I/O Profile	77
Configuration of the Drive for Operation with CiA 402 Profile in Combined Mode	78
Configuration of the Drive for Operation with CiA 402 Profile in Separate Mode	79

Configuring the Control Channel

Overview

This chapter explains how to configure the drive for operation from communication network through three following examples.

- I/O mode - a simple command word (based on forward, reverse, and reset binary commands).
- Combined mode (with native profile CiA 402) - Both reference value and command word come from the communication network.
- Separate (with native profile CiA 402) - reference value and command come from separate sources: for example, the command (in CiA 402) comes from the communication network and the reference value from the HMI.

Configuration of the Drive for Operation in I/O Profile

Description

For the I/O profile, here is a simple example, which can be extended with additional features. The command word is made of run forward (bit 0 of CMd), run reverse (bit 1 of CMd), and the function fault reset (bit 7 of CMd). The reference frequency value is given by Graphic Display Terminal.

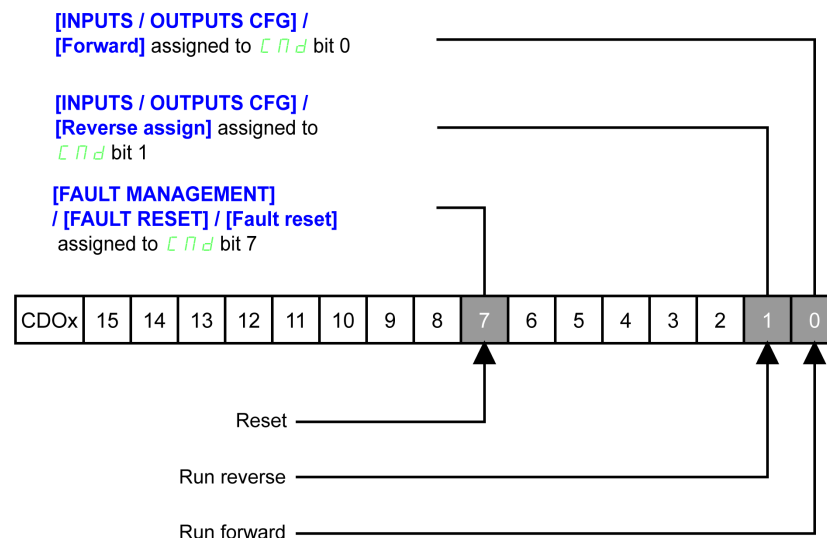

The settings are the following:

[Ref Freq 1 Config] <i>F r 1</i>	
[Control Mode] <i>CHCF</i>	[I/O profile] <i>IO</i>
[Command switching] <i>CCS</i>	[Cmd Channel 1] <i>CD1</i>
[Cmd channel 1] <i>CD1</i>	[Com. Module] <i>RET</i>

The bits of the command word can now be configured.

In the **[INPUTS / OUTPUTS CFG]** *IO* - menu configure:

[Reverse Assign] <i>RS5</i>	[CD01] <i>CD01</i>
------------------------------------	---------------------------

In the **[FAULT MANAGEMENT]** *FLt* - menu, **[Fault Reset]** *RSF* - submenu, configure:

[Fault Reset] <i>RSF</i>	[CD07] <i>CD07</i>
---------------------------------	---------------------------

Configuration of the Drive for Operation with CiA 402 Profile in Combined Mode

Description

This section describes how to configure the settings of the drive if it is controlled in CiA 402 mode. The example focuses on the not separate mode. Additional modes are detailed in the drive programming manual.

In the **[Command] C E L** - menu:

- **[Ref Freq Channel 1] F r 1**: is set on according to the communication source you can choose in the following table:

Origin of the Control	Ref1 Channel Setting
EtherCAT	[Com. Module] r E t

- **[Freq Switch Assign] r F C** is set to default value (**[Ref Freq 1 Config] F r 1**).
- **[Control Mode] C H C F**: defines if the drive operates in combined mode (reference and command from the same channel).

For the current example, **[Control Mode] C H C F** is adjusted to **[Not separ.] 5 , 11** as reference and control are originated from the communication network.

Profile	Ref1 Channel setting
CiA 402 combined mode	[Not separ.] 5 , 11
CiA 402 separate mode	[Separate] 5 E P
I/O profile	[I/O profile] , 0

Configuration of the Drive for Operation with CiA 402 Profile in Separate Mode

Description

Alternate combinations are possible, see the drive programming manual for the list of possible settings.

For example:



The drive is controlled from the fieldbus (EtherCAT) but the reference value is adjusted on the display terminal. The control word comes from the controller and is written according to CiA 402 profile.

The settings are as shown in the table:

[Ref Freq 1 Config] <i>F r I</i>	[HMI] <i>H Π i</i>
[Control Mode] <i>L H C F</i>	[Separate] <i>S E P</i>
[Cmd channel 1] <i>L d I</i>	[Com. Module] <i>n E t</i>
[Freq Switch Assign] <i>r F C</i>	[Ref Freq Channel 1] <i>F r I</i>
[Command Switching] <i>L C 5</i>	[Cmd Channel 1] <i>L d I</i>

Chapter 6

Diagnostics and Troubleshooting

What Is in This Chapter?

This chapter contains the following topics:

Topic	Page
Fieldbus Status LEDs	82
Connection for Fieldbus Mode	84
Monitoring of Communication Channel	85
Control-Signal Diagnostics	87

Fieldbus Status LEDs

LED Indicators

The following figure describes the LEDs status for the module:



LED Description

Item	LED	Description
1	X1	Link/Activity on X1 port
2	RUN	EtherCAT status
3	ERR	EtherCAT error
4	X2	Link/Activity on X2 port

LEDs 1 and 4: Link/Activity

These LEDs indicate the status of the EtherCAT port X1 and X2.

Color & status	Description
OFF	No link
Green ON	Link, no activity
Green Flickering	Link, activity

LED 2: RUN Status

This LED indicates the EtherCAT status:

Color & Status	Description
OFF	EtherCAT state: INIT
Green blinking	EtherCAT state: PRE-OPERATIONAL
Green single flashing	EtherCAT state: SAFE-OPERATIONAL
Green ON	EtherCAT state: OPERATIONAL

LED 3: Network Error Status

This LED indicates the EtherCAT error status:

Color & Status	Description
OFF	No detected error
Red blinking	Invalid configuration
Red single flashing	Local error (such as synchronization error)
Red double flashing	Watchdog timeout

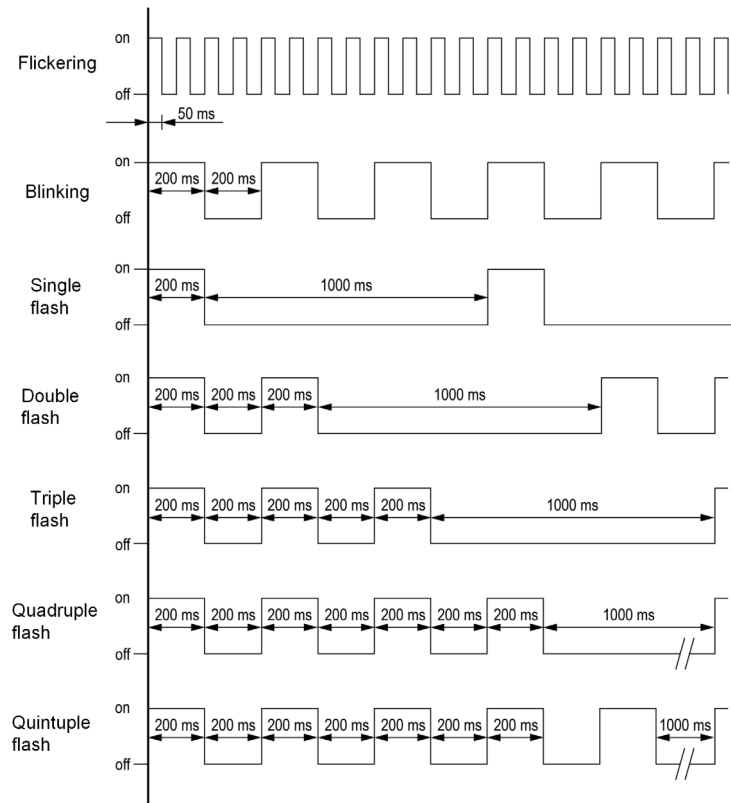

ESM Chart

The **[EthCat slave status] E L 5 5** parameter (logic address 6690), indicates the ESM chart state. This parameter is accessible in the **[Communication] L 0 11**, **[EtherCAT Module] E L L** - menu.

Connection for Fieldbus Mode

Description

If the product cannot be addressed via the fieldbus, first check the connections. The product manual contains the technical data of the device and information on network and device installation. Check the following:

- Power connections to the device.
- Fieldbus cable and fieldbus wiring.
- Network connection to the device.

Monitoring of Communication Channel

Command and Reference Channels

All the drive command and reference parameters are managed on a channel-by-channel basis.

Parameter Name	Parameter Code			
	Taken Into Account by the Drive	Modbus Serial	CANopen	Fieldbus Module
Control word	<i>CNd</i>	<i>CNd1</i>	<i>CNd2</i>	<i>CNd3</i>
Extended control word	<i>CNi</i>	<i>CNi1</i>	<i>CNi2</i>	<i>CNi3</i>
Reference speed (rpm)	<i>LFrD</i>	<i>LFrD1</i>	<i>LFrD2</i>	<i>LFrD3</i>
Reference frequency (0.1 Hz)	<i>LFr</i>	<i>LFr1</i>	<i>LFr2</i>	<i>LFr3</i>
Reference for torque control mode (0.1% of the normal torque)	<i>Ltr</i>	<i>Ltr1</i>	<i>Ltr2</i>	<i>Ltr3</i>
Reference value supplied by PI controller	<i>PiSP</i>	<i>Pir1</i>	<i>Pir2</i>	<i>Pir3</i>
Reference value supplied by analog multiplier function	<i>PFr</i>	<i>PFr1</i>	<i>PFr2</i>	<i>PFr3</i>

Network Monitoring Criteria

The table provides the details on network monitoring criteria:

Protocol	Criteria	Related detected error
EtherCAT module	0: Not network interruption	[Fieldbus Com Interrupt] <i>CnF</i>
	1: Unspecified interruption	
	11: Link loss (2 ports)	
	23: Invalid Sync Manager configuration	
	25: No valid outputs	
	27: Sync Manager watchdog (1port)	
	29: Invalid Sync Manager output configuration	
	30: Invalid Sync Manager input configuration	
	31: Invalid watchdog configuration	
	36: Invalid input mapping	
	37: Invalid output mapping	
	38: Inconsistent settings	
	43: No valid inputs and outputs	
	44: Sync error	
	80: No access to EEPROM	
	81: EEPROM error	
	96: Generic error	
18: Interface connection timeout	[Internal Link Error] <i>L F</i>	
19: EEPROM detected error		
21: No memory or Background watchdog or IOC scanner detected error		

Monitoring of Communication Channels

Communication channels are monitored if they are involved in one of the following parameters:

- The control word (**[Cmd Register]** *C P d*) from the active command channel
- The control word containing the command switch (bit configured on **[Cmd switching]** *C C 5*)
- The control word containing the switch for reference value 1'1B (bit configured on **[Ref 1B switching]** *r C b*)
- The control word containing the switch for reference value 1'2 (bit configured on **[Freq Switch Assign]** *r F C*)
- The reference frequency or reference speed (**[Ref Frequency]** *L F r* or *L F r d*: Nominal speed value) from the active channel for reference value
- Summing reference frequency or reference speed (**[Ref Frequency]** *L F r* or *L F r d*: Nominal speed value) 2 (assigned to **[Summing Input 2]** *S A 2*)
- Summing reference frequency or reference speed (**[Ref Frequency]** *L F r* or *L F r d*: Nominal speed value) 3 (assigned to **[Summing Input 3]** *S A 3*)
- Subtracting reference frequency or reference speed (**[Ref Frequency]** *L F r* or *L F r d*: Nominal speed value) 2 (assigned to **[Subtract Ref Freq 2]** *d A 2*)
- Subtracting reference frequency or reference speed (**[Ref Frequency]** *L F r* or *L F r d*: Nominal speed value) 3 (assigned to **[Subtract Ref Freq 3]** *d A 3*)
- The reference value given by the PID controller *P , S P*
- The PID controller feedback (**[AI Virtual 1]** *A i u l*)
- The multiplication coefficient of the reference values (**[Multiplying coeff.]** *P F r 2* (assigned to **[Ref Freq 2 Multiply]** *P A 2*)
- The multiplication coefficient of the reference values (**[Multiplying coeff.]** *P F r 3* (assigned to **[Ref Freq 3 Multiply]** *P A 3*)

As soon as one of these parameters has been written once to a communication channel, it activates monitoring for that channel.

If a communication warning is sent (in accordance with the protocol criteria) by a monitored port or fieldbus module, the drive triggers a communication interruption.

The drive reacts according to the communication interruption configuration (operating state Fault, maintenance, fallback, and so on)

If a communication warning occurs on a channel that is not being monitored, the drive does not trigger a communication interruption.

Enabling of Communication Channels

A communication channel is enabled once all the parameters involved have been written at least one time. The drive is only able to start if all channels involved in command and reference value are enabled.

For example:

A drive in DSP402 profile is connected to an active communication channel.

It is mandatory to write at least 1 time the reference value and the command in order to switch from 4-Switched on to 5-Operation enabled state.

A communication channel is disabled:

- In the event of a communication warning.
- In forced local mode.

NOTE: On exiting forced local mode:

- The drive copies the `run` commands, the direction, and the forced local reference value to the active channel (maintained).
- Monitoring of the active channels for the command and reference value resumes following a time delay **[Time-out forc. local]** *F L o E*.
- Drive control only takes effect once the drive has received the reference value and the command from the active channels.

Control-Signal Diagnostics

Introduction

On the display terminal, the **[Display] 0 0 -**, **[Communication map] 0 0 0 -** submenu can be used to display control-signal diagnostic information between the drive and the controller:

- Active command channel **[Command Channel] 0 0 0 0**
- Value of the control word **[Cmd Register] 0 0 0** from the active command channel **[Command Channel] 0 0 0 0**
- Active reference frequency channel **[Ref Freq Channel] 0 0 0 0**
- Value of the reference frequency **[Pre-Ramp Ref Freq] 0 0 0** from the active target channel **[Ref Freq Channel] 0 0 0 0**
- Value of the operating state word **[CIA402 State Reg] 0 0 0**
- Specific data for all available fieldbus are in dedicated submenus.
- In the **[Command word image] 0 0 0 -** submenu: control words from all channels
- In the **[Freq. ref. word map] 0 0 0 -** submenu: reference frequency values produced by all channels

Control Word Display

The **[Command Channel] 0 0 0 0** parameter indicates the active command channel.

The **[Cmd Register] 0 0 0** parameter indicates the hexadecimal value of the control word (CMD) used to control the drive.

The **[Command word image] 0 0 0 -** submenu (**[COM. Module cmd.] 0 0 0 0**) parameter is used to display the hexadecimal value of the control word from the fieldbus module.

Reference Frequency Display

The **[Ref Freq Channel] 0 0 0 0** parameter indicates the active channel for reference frequency.

The **[Ref Frequency] 0 0 0** parameter indicates the value (in 0.1 Hz units) of the reference frequency used to control the drive.

The **[Freq. ref. word map] 0 0 0 -** submenu (**[Com Module Ref Freq] 0 0 0 0**) parameter is used to display the value (in 0.1 Hz units) of the reference frequency from the fieldbus.

Operating State Word Display

The **[CIA402 State Reg] 0 0 0** parameter gives the value of the operating state word (ETA).

The table provides the bit details of **0 0 0** parameter:

Bit	Description
DRIVECOM	Status word
Bit0 = 1	Ready to switch on
Bit1 = 1	Switched on
Bit2 = 1	Operation enabled
Bit3 = 1	Operating state fault
Bit4 = 1	Power stage is switched on
Bit5 = 0	Quick stop
Bit6 = 1	Switch on disabled
Bit7 = 1	Warning
Bit8 = 1	Drivecom reserved
Bit9 = 0	Forced local mode in progress
Bit10 = 1	Reference value reached (steady state)
Bit11 = 1	Reference value exceeded (< LSP or > HSP)
Bit12	Reserved
Bit13	Reserved
Bit14 = 1	Stop imposed via STOP key
Bit15 = 0	Motor rotation in forward direction (or stopped)



A

Abbreviations

Req. = Required

Opt. = Optional

C

CAN

Controller Area Network is an internally standardized serial bus system

COB

Communication Object. A unit of transportation in a CAN network. Data must be sent across a CAN Network inside a COB. There are 2048 different COB's in a CAN network. A COB can contain at most 8 bytes of data.

COB ID

Each COB is uniquely identified in a CAN network by a number called the COB Identifier (COB-ID).

D

Display terminal

The display terminal menus are shown in square brackets.

For example: **[Communication]**

The codes are shown in round brackets.

For example: **(C a 1) -**

Parameter names are displayed on the display terminal in square brackets.

For example: **[Fallback Speed]**

Parameter codes are displayed in round brackets.

For example: **(L F F)**

E

Error

Discrepancy between a detected (computed, measured, or signaled) value or condition and the specified or theoretically correct value or condition.

ESM

EtherCAT State Machine

F

Factory setting

Default configuration of the product.

Fault

Fault is an operating state. If the monitoring functions detect an error, a transition to this operating state is triggered, depending on the error class. A "Fault reset" is required to exit this operating state after the cause of the detected error has been removed. Further information can be found in the pertinent standards such as IEC 61800-7, ODVA Common Industrial Protocol (CIP).

Fault Reset

A function used to restore the drive to an operational state after a detected error is cleared by removing the cause of the error so that the error is no longer active.

L**LSB**

Least Significant Byte

M**MEI**

Modbus Encapsulated Interface

Monitoring function

Monitoring functions acquire a value continuously or cyclically (for example, by measuring) in order to check whether it is within permissible limits. Monitoring functions are used for error detection.

MSB

Most Significant Byte

N**NMT**

Network Management. One of the service elements of the application layer in the CAN Reference Model. The NMT serves to configure, initialize, and handle detected errors in a CAN network.

P**Parameter**

Device data and values that can be read and set (to a certain extent) by the user.

PDO

Process Data Object

PELV

Protective Extra Low Voltage, low voltage with isolation. For more information: IEC 60364-4-41

PLC

Programmable logic controller

Power stage

The power stage controls the motor. The power stage generates current for controlling the motor.

Q**Quick Stop**

The quick Stop function can be used for fast deceleration of a movement as a response to a detected error or via a command.

R**RPDO**

Receive PDO

S**SYNC**

Synchronization Object

T**TPDO**

Transmit PDO

V**VSD**

Variable Speed Drive

W**Warning**

If the term is used outside the context of safety instructions, a warning alerts to a potential problem that was detected by a monitoring function. A warning does not cause a transition of the operating state.

Z**Zone of operation**

This term is used in conjunction with the description of specific hazards, and is defined as it is for a **hazard zone** or **danger zone** in the EC Machinery Directive (2006/42/EC) and in ISO 12100-1.

