

MOTOR SPECIFICATIONS

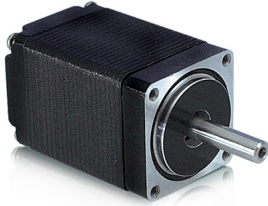

Part Number	WO-211-18-01
Step Angle	1.8°
Frame Size	NEMA 11
Body Length (Dim. A)	1.77 in (45 mm)
Current	0.67 Amps/Phase
Holding Torque	13.7 oz-in (0.1 Nm)
Resistance	7.1 Ohms/Phase
Rotor Inertia	0.07 oz-in ²
Number of Leads	4
Connection	Bipolar
Weight	0.31 lbs (0.14 kg)

DIMENSIONS

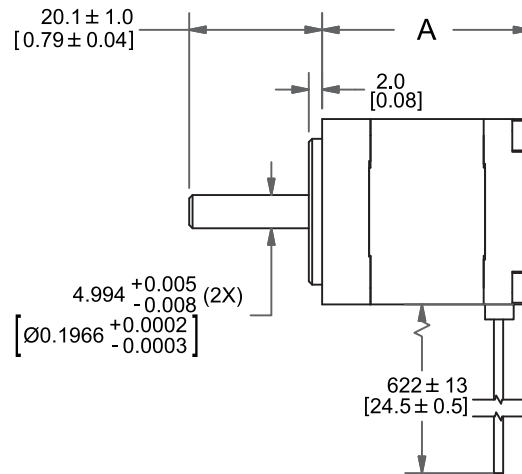
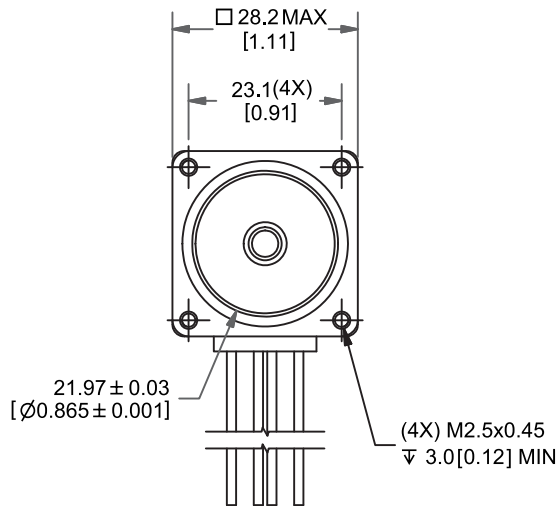

PERFORMANCE CURVE

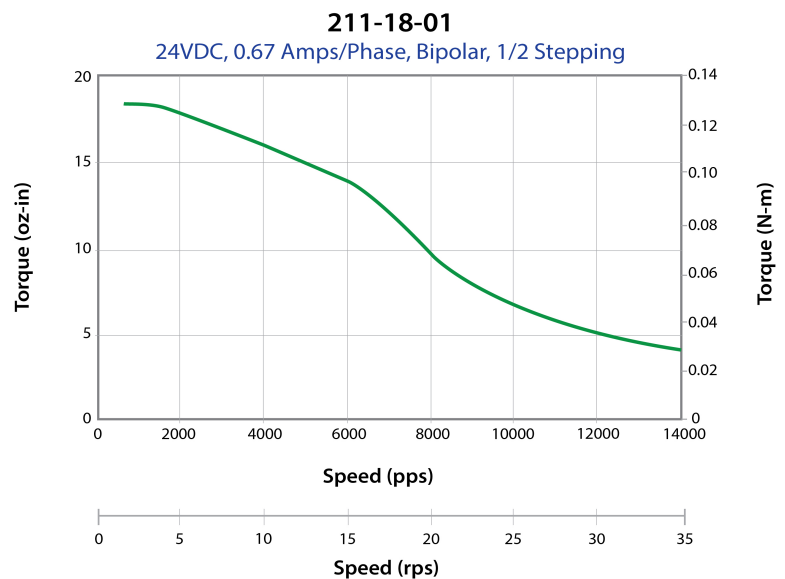

OPERATING SPECIFICATIONS

Radial Play	0.001" max @ 1 lbs load
End Play	0.003" max @ 2 lbs load
Shaft Run Out	0.002" TIR
Concentricity of Mounting Pilot to Shaft	0.003" TIR
Perpendicularity of Shaft to Mounting Face	0.003" TIR
Max Axial Load	2.25 lbs
Maximum Case Temperature	60 C
Ambient Temperature	-20° to 50° C
Storage Temperature	-20° to 100° C
Humidity Range	85% or less, non-condensing
Magnet Wire Insulation	Class B 130° C
Insulation Resistance	100MΩ at 500 VDC
Dielectric Strength	500 VAC for 1 minute

WIRING TABLE

COLOR	FUNCTION
Red	A+ Phase
Blue	A- Phase
Green	B + Phase
Black	B- Phase

OPERATION & USAGE TIPS



Do not disassemble motors; a significant reduction in motor performance will occur.



Do not machine shafts; this will have a negative effect on shaft run out and perpendicularity.

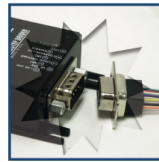

Do not disconnect motor from drive while in operation.

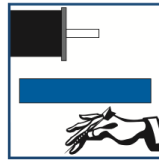

Do not use holding torque/detent torque of motor as a fail safe brake.

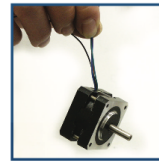

Do not hold motor by lead wires.



Do not exceed the rated current; this will burn the motor.

FAILURE TO COMPLY WITH THESE RECOMMENDATIONS WILL VOID ALL WARRANTY TERMS

RECOMMENDED



Microstepping Driver
R208



S.O. VERIFICATION

- ✓ Pricing
- ✓ Delivery
- ✓ P/N
- ✓ Revision Level
- ✓ Terms and Condition Verification
- ✓ Commission Rep

By Timmy, May 18, 2022, 1:59 pm

Motion Control, **Solved.**

MOTOR ENGINEERING & MANUFACTURING



Optimized
For Your
Application



Quick
Prototype
Turnaround



Small Batch
to OEM Volume
Production



US Based
Support &
Manufacturing