

# Background suppression sensor VT18-8-H-120-M/32/40a/65b/118

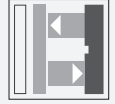

- Adjustable background suppression
- Array control panel with highly visible LED display
- Flashing power on LED in case of short-circuit
- Multiple device installation possible, no mutual interference (no cross-talk)
- Not sensitive to ambient light, even with switched energy saving lamps
- Protection class II

Background suppression sensor, 120 mm adjustable detection range, red light, light/dark on, PNP output, M12 plug



## Dimensions

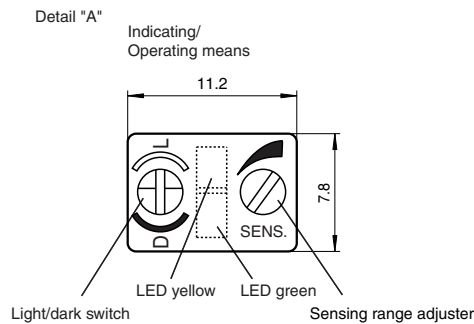
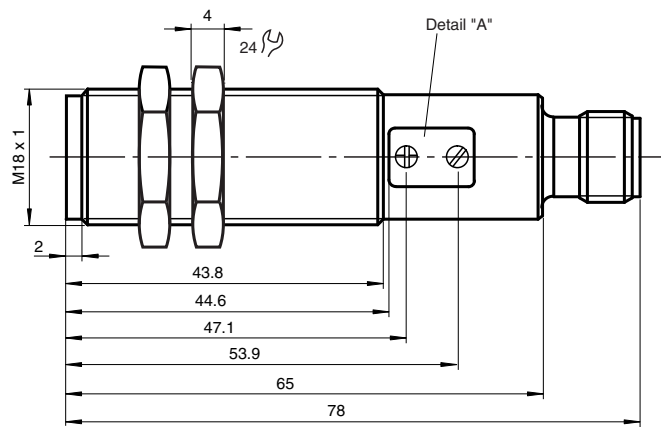

Unit connector



Release date: 2022-08-08 Date of issue: 2022-08-08 Filename: 800189\_eng.pdf

Refer to "General Notes Relating to Pepperl+Fuchs Product Information".

Pepperl+Fuchs Group  
www.pepperl-fuchs.com

USA: +1 330 486 0001  
fa-info@us.pepperl-fuchs.com

Germany: +49 621 776 1111  
fa-info@de.pepperl-fuchs.com

Singapore: +65 6779 9091  
fa-info@sg.pepperl-fuchs.com

**PEPPERL+FUCHS**

## Technical Data

<b>General specifications</b>		
Detection range		20 ... 120 mm , adjustable
Detection range min.		20 ... 40 mm
Detection range max.		20 ... 120 mm
Light source		LED
Light type		modulated visible red light 660 nm
Black-white difference (6 %/90 %)		< 10 % at a distance of 120 mm
Diameter of the light spot		approx. 6 mm at a distance of 120 mm
Optical face		frontal
Ambient light limit		30000 Lux
<b>Functional safety related parameters</b>		
MTTF <sub>d</sub>		860 a
Mission Time (T <sub>M</sub> )		20 a
Diagnostic Coverage (DC)		0 %
<b>Indicators/operating means</b>		
Operation indicator		LED green, flashes in case of short-circuit
Function indicator		LED yellow, lights up with receiver lit
Control elements		Sensing range adjuster, light-on/dark-on changeover switch
<b>Electrical specifications</b>		
Operating voltage	U <sub>B</sub>	10 ... 30 V DC
Ripple		10 %
No-load supply current	I <sub>0</sub>	< 35 mA
Protection class		II , rated voltage ≤ 50 V AC with pollution degree 1-2 according to IEC 60664-1
<b>Output</b>		
Switching type		light/dark on, switchable
Signal output		1 PNP output, short-circuit protected, reverse polarity protected, open collector
Switching voltage		30 V DC
Switching current		max. 200 mA
Switching frequency	f	500 Hz
Response time		1 ms
<b>Conformity</b>		
Product standard		EN 60947-5-2
<b>Approvals and certificates</b>		
CE conformity		yes
EAC conformity		TR CU 020/2011
UL approval		cULus Listed, Type 1 enclosure
CCC approval		CCC approval / marking not required for products rated ≤36 V
<b>Ambient conditions</b>		
Ambient temperature		-25 ... 70 °C (-13 ... 158 °F)
Storage temperature		-30 ... 70 °C (-22 ... 158 °F)
<b>Mechanical specifications</b>		
Degree of protection		IP67
Connection		4-pin, M12 x 1 connector
Material		
Housing		brass, nickel-plated
Optical face		PMMA
Mass		60 g

**Connection Assignment**

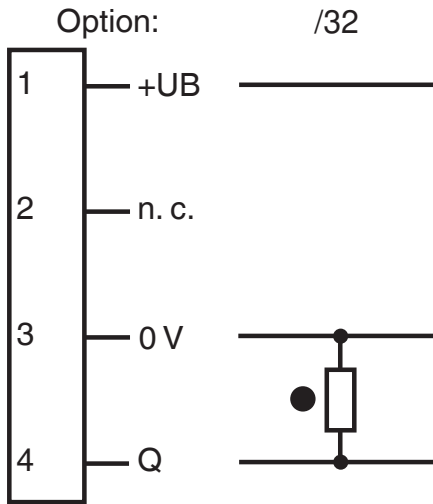

○ = Light on  
● = Dark on

**Connection Assignment**

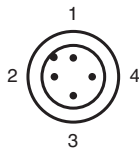

Wire colors in accordance with EN 60947-5-2

1	BN	(brown)
2	WH	(white)
3	BU	(blue)
4	BK	(black)

**Characteristic Curve**

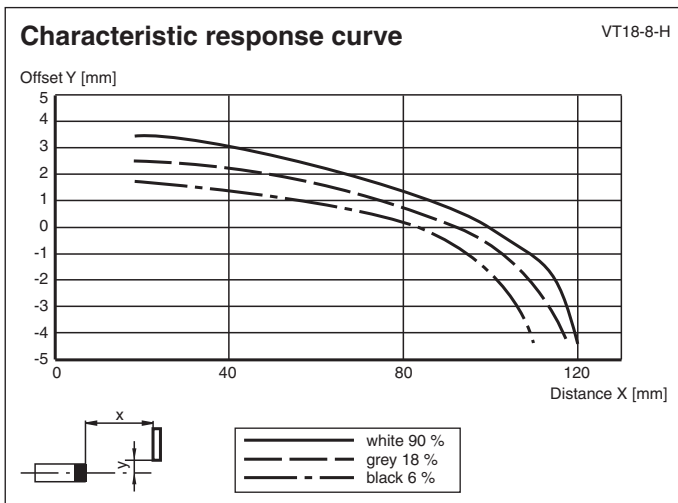

Release date: 2022-08-08 Date of issue: 2022-08-08 Filename: 800189\_eng.pdf

Refer to "General Notes Relating to Pepperl+Fuchs Product Information".

Pepperl+Fuchs Group  
www.pepperl-fuchs.com

USA: +1 330 486 0001  
fa-info@us.pepperl-fuchs.com

Germany: +49 621 776 1111  
fa-info@de.pepperl-fuchs.com

Singapore: +65 6779 9091  
fa-info@sg.pepperl-fuchs.com

**Characteristic Curve**

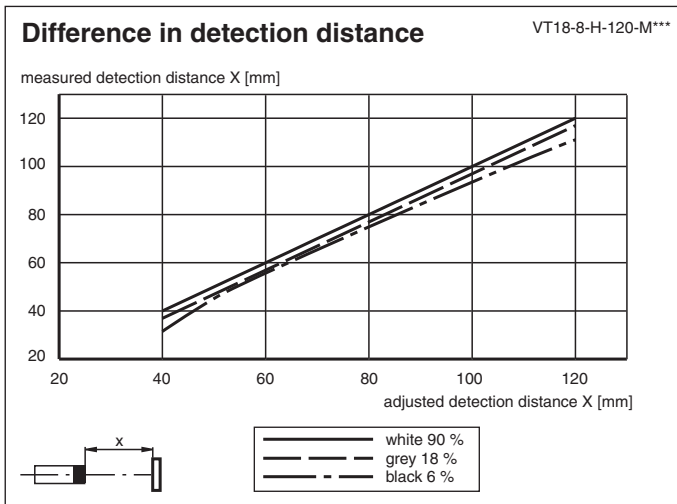

Release date: 2022-08-08 Date of issue: 2022-08-08 Filename: 800189\_eng.pdf

Refer to "General Notes Relating to Pepperl+Fuchs Product Information".

Pepperl+Fuchs Group  
www.pepperl-fuchs.com

USA: +1 330 486 0001  
fa-info@us.pepperl-fuchs.com

Germany: +49 621 776 1111  
fa-info@de.pepperl-fuchs.com

Singapore: +65 6779 9091  
fa-info@sg.pepperl-fuchs.com