

## Open Carrier Frequency Doubler For Microwave Telecommunications

Rev. V1

### Features

- Input Frequency 1.5 to 8.0 GHz
- Output Frequency 3.0 to 16.0 GHz
- Input Drive Level +10 dBm (nominal)
- Microstrip Interface

### Description

The FDC2310 is a passive bridge diode frequency doubler, designed for use in military, commercial and test equipment applications. The design utilizes Schottky bridge quad diodes and broadband soft dielectric baluns to attain excellent performance. Environmental screening available to MIL-STD-883, MIL-STD-202, or MIL-DTL-28837, consult factory.

### Product Image

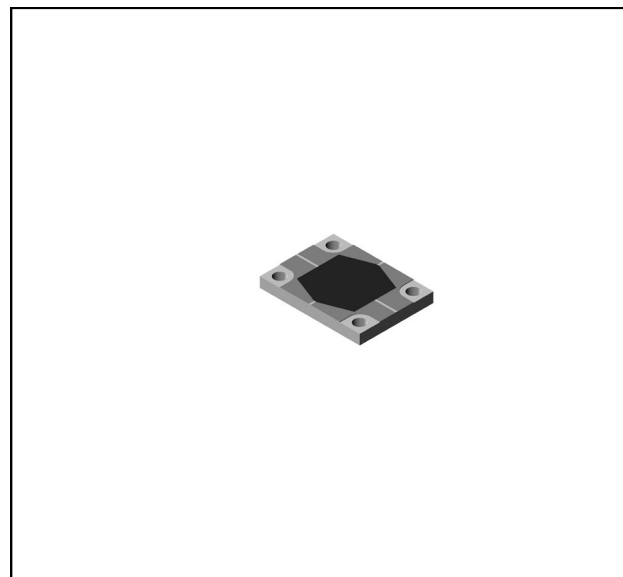

### Ordering Information

Part Number	Package
FDC2310	Open Carrier

### Electrical Specifications: $Z_0 = 50\Omega$ $P_{in} = +10$ dBm

Parameter	Test Conditions	Units	Typical	Guaranteed	
				+25°C	-40° to +85°C
SSB Conversion Loss (max)	$f_{in} = 1.5$ to 8.0 GHz	dB	11	14.0	14.5
Fundamental Suppression (min)	$f_{in} = 1.5$ to 8.0 GHz	dBc	35	19.5	19
Third Harmonic Suppression (min)	$f_{in} = 1.5$ to 8.0 GHz	dBc	40	20	18
Input VSWR	$f_{in} = 1.5$ to 8.0 GHz		2.0:1		

## Open Carrier Frequency Doubler For Microwave Telecommunications

Rev. V1

### Typical Performance Curves

Conversion Loss

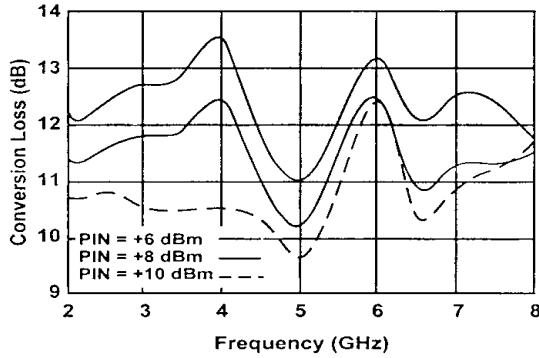

Conversion Loss

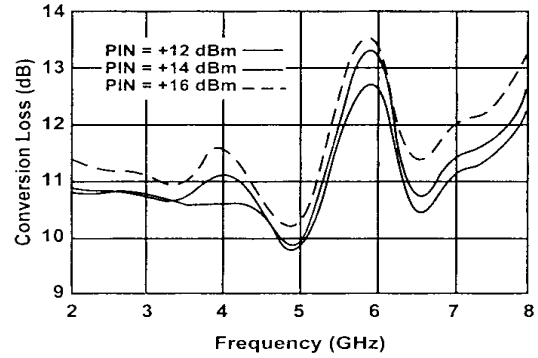

Input VSWR

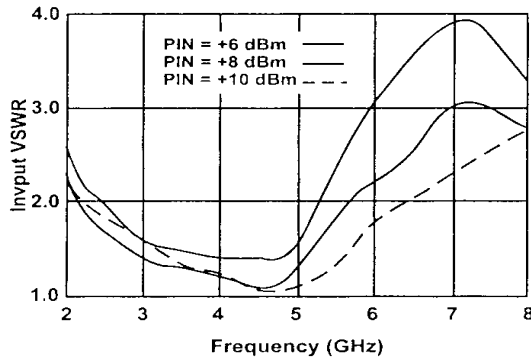

Input VSWR

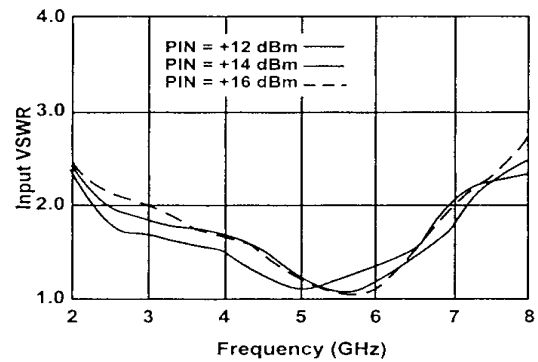

Fundamental Suppression

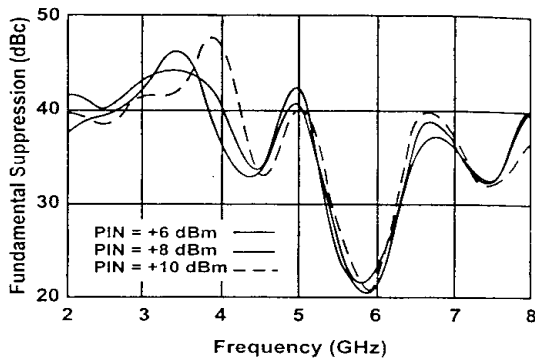

Fundamental Suppression

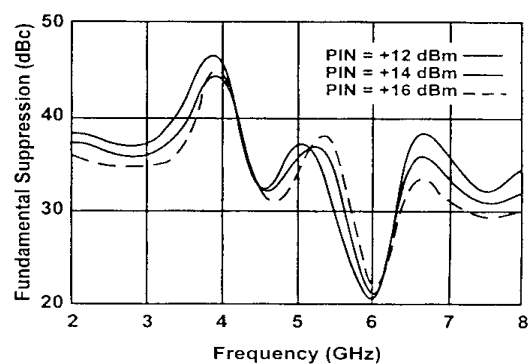

## Open Carrier Frequency Doubler For Microwave Telecommunications

Rev. V1

### Absolute Maximum Ratings

Parameter	Absolute Maximum
Operating Temperature	-54°C to +100°C
Storage Temperature	-65°C to +100°C
Peak Input Power	+23 dBm max @ +25°C +20 dBm max @ +100°C
Peak Input Current	50 mA DC

### Outline Drawing: Open Carrier \*

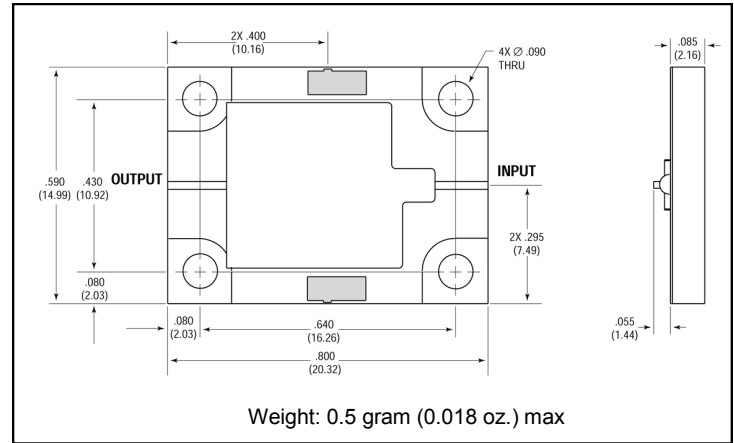

### Third Harmonic Suppression

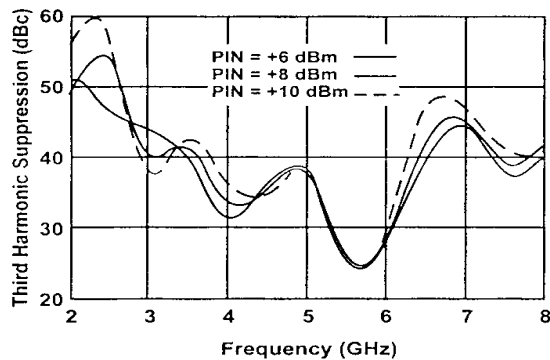

\* Dimensions are inches (millimeters)  $\pm 0.015$  (0.38) unless otherwise specified.

### Third Harmonic Suppression

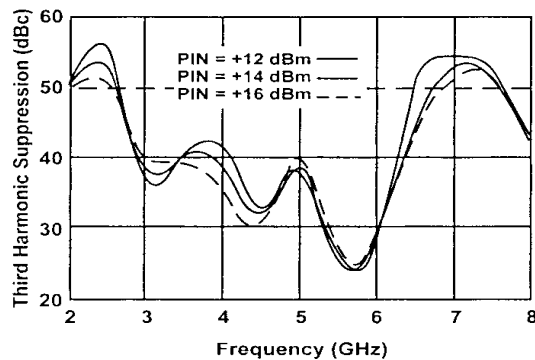

M/A-COM Technology Solutions Inc. All rights reserved.

Information in this document is provided in connection with M/A-COM Technology Solutions Inc ("MACOM") products. These materials are provided by MACOM as a service to its customers and may be used for informational purposes only. Except as provided in MACOM's Terms and Conditions of Sale for such products or in any separate agreement related to this document, MACOM assumes no liability whatsoever. MACOM assumes no responsibility for errors or omissions in these materials. MACOM may make changes to specifications and product descriptions at any time, without notice. MACOM makes no commitment to update the information and shall have no responsibility whatsoever for conflicts or incompatibilities arising from future changes to its specifications and product descriptions. No license, express or implied, by estoppel or otherwise, to any intellectual property rights is granted by this document.

THESE MATERIALS ARE PROVIDED "AS IS" WITHOUT WARRANTY OF ANY KIND, EITHER EXPRESS OR IMPLIED, RELATING TO SALE AND/OR USE OF MACOM PRODUCTS INCLUDING LIABILITY OR WARRANTIES RELATING TO FITNESS FOR A PARTICULAR PURPOSE, CONSEQUENTIAL OR INCIDENTAL DAMAGES, MERCHANTABILITY, OR INFRINGEMENT OF ANY PATENT, COPYRIGHT OR OTHER INTELLECTUAL PROPERTY RIGHT. MACOM FURTHER DOES NOT WARRANT THE ACCURACY OR COMPLETENESS OF THE INFORMATION, TEXT, GRAPHICS OR OTHER ITEMS CONTAINED WITHIN THESE MATERIALS. MACOM SHALL NOT BE LIABLE FOR ANY SPECIAL, INDIRECT, INCIDENTAL, OR CONSEQUENTIAL DAMAGES, INCLUDING WITHOUT LIMITATION, LOST REVENUES OR LOST PROFITS, WHICH MAY RESULT FROM THE USE OF THESE MATERIALS.

MACOM products are not intended for use in medical, lifesaving or life sustaining applications. MACOM customers using or selling MACOM products for use in such applications do so at their own risk and agree to fully indemnify MACOM for any damages resulting from such improper use or sale.