

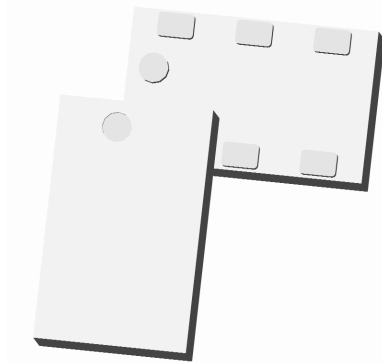

**Ultra Low Profile 0805
3 dB, 90° Hybrid Coupler**

Description:



The C1015J5003AHF is a low cost, low profile sub-miniature high performance 3 dB coupler in an easy to use surface mount package. The C1015J5003AHF is ideal for balanced power and low noise amplifiers, plus signal distribution and other applications where low insertion loss, tight amplitude and phase balance are required. The C1015J5003AHF is available on tape and reel for pick and place high volume manufacturing.

All of the Xinger components are constructed from ceramic filled PTFE composites which possess excellent electrical and mechanical stability. All parts have been subjected to rigorous qualification testing and units are 100% RF tested.

Detailed Electrical Specifications:

Specifications subject to change without notice.

Features:

- 1000 – 1606 MHz
- 0.7 mm Height Profile
- Surface Mountable
- Tape & Reel
- RoHS Compliant
- Halogen-Free

Parameter	Room (25°C)			Room (25°C)			Unit
	Typ	Max	Max	Typ	Max	Max	
Frequency	1000		1500	1166		1606	MHz
Port Impedance		50			50		Ω
Return Loss	17	20		17	20		dB
Isolation	20	25		20	25		dB
Insertion Loss*		0.5	0.7		0.5	0.7	dB
Amplitude Balance		0.84	1.1		0.84	1.1	dB
Phase Balance		3.8	7		3.8	7	Degrees
Power Handling @85°C			4			4	Watts
Operating Temperature	-55		+140	-55		+140	°C

*Specification based on performance of unit properly installed on microstrip printed circuit boards with 50 Ω nominal impedance.

Outline Drawing

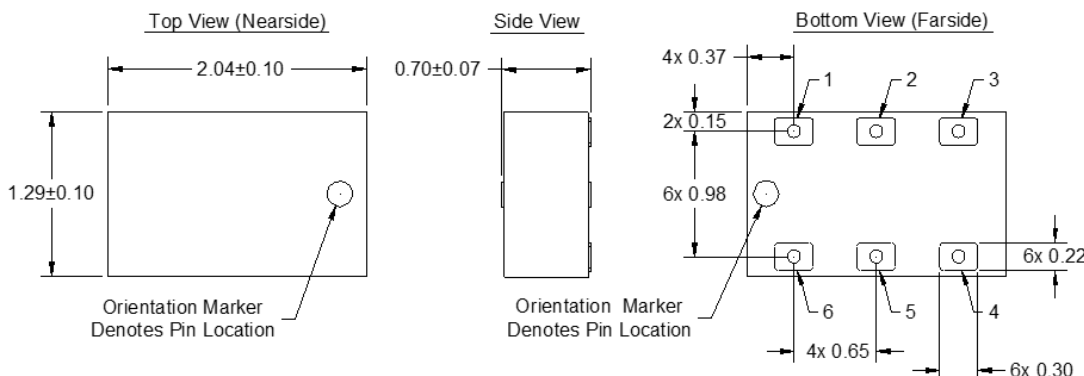

Pin	Configuration-1	Configuration-2	Configuration-3	Configuration-4
1	Input	Isolated	Direct	Coupled
2	GND	GND	GND	GND
3	Isolated	Input	Coupled	Direct
4	Direct	Coupled	Input	Isolated
5	GND	GND	GND	GND
6	Coupled	Direct	Isolated	Input

Mechanical Outline
-Dimensions are in Millimeters
-Tolerances are Non-Cumulative

Typical Broadband Performance: 500 MHz. to 6000 MHz.

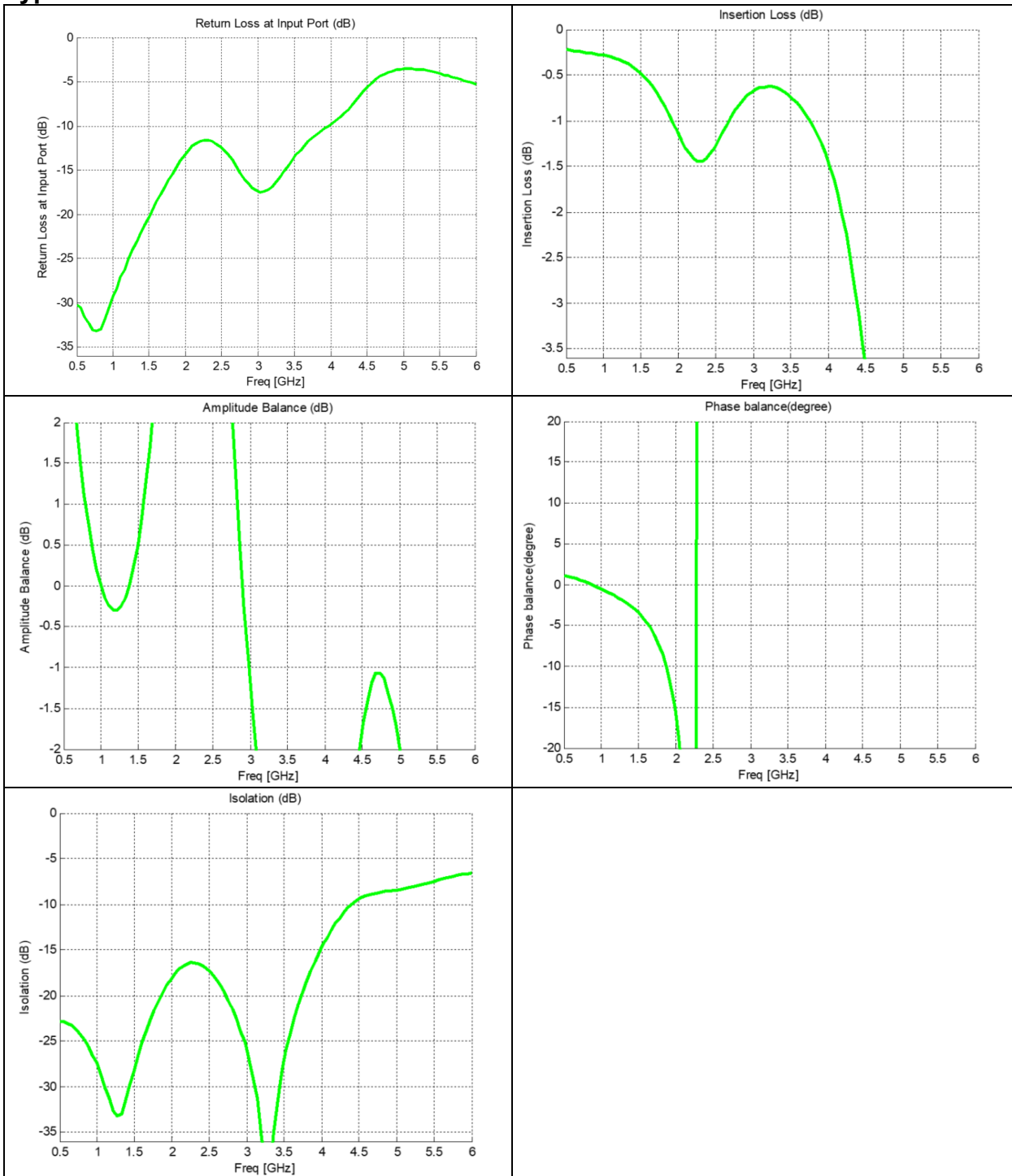

Typical Performance: 900 MHz. to 1600 MHz.

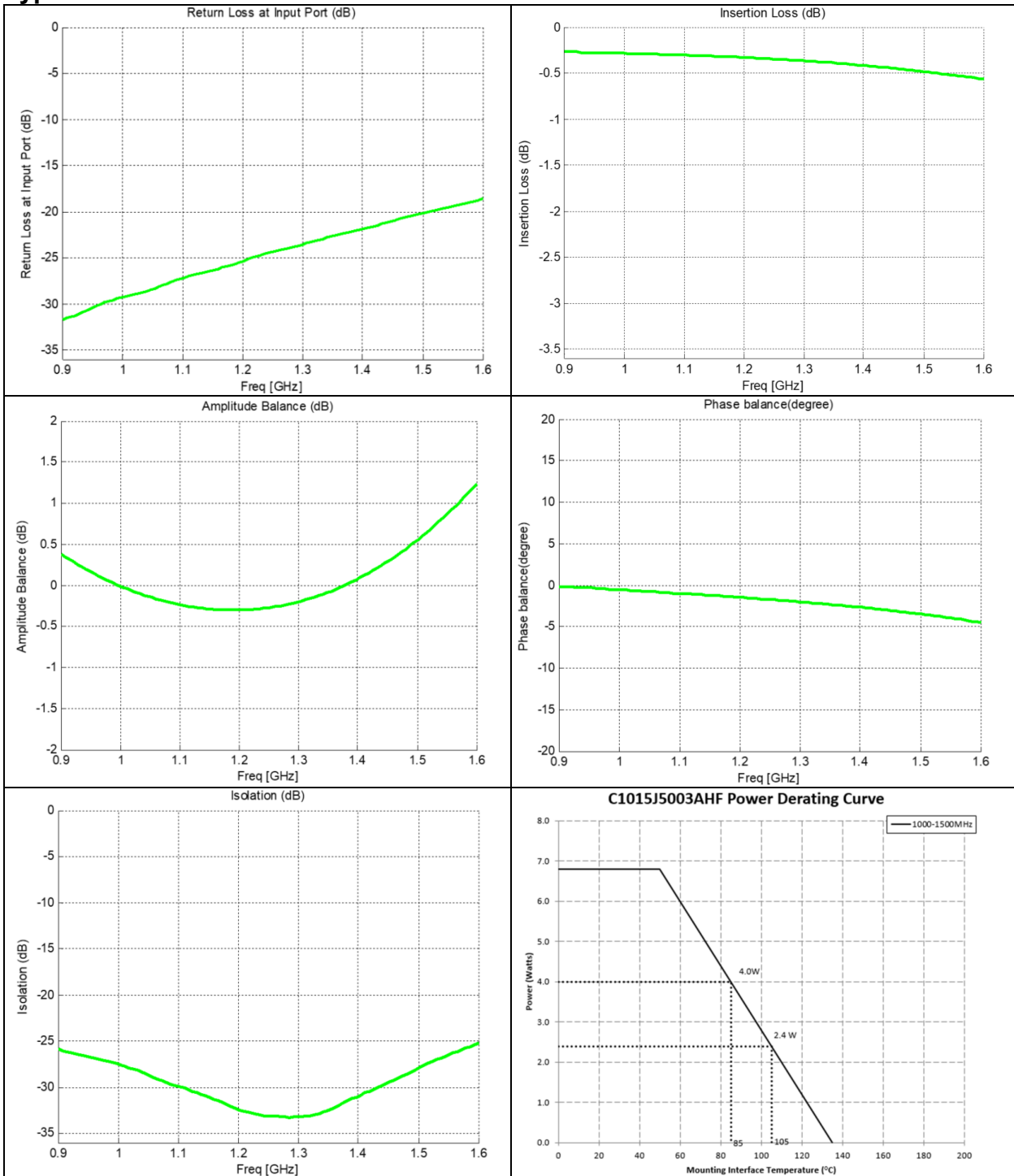

Definition of Measured Specifications

Parameter	Definition	Mathematical Representation
VSWR (Voltage Standing Wave Ratio)	The impedance match of the coupler to a 50Ω system. A VSWR of 1:1 is optimal.	$VSWR = \frac{V_{max}}{V_{min}}$ Vmax = voltage maxima of a standing wave Vmin = voltage minima of a standing wave
Return Loss	The impedance match of the coupler to a 50Ω system. Return Loss is an alternate means to express VSWR.	$Return\ Loss(dB) = 20\log \frac{VSWR + 1}{VSWR - 1}$
Insertion Loss	The input power divided by the sum of the power at the two output ports.	$Insertion\ Loss(dB) = 10\log \frac{P_{in}}{P_{cpl} + P_{direct}}$
Isolation	The input power divided by the power at the isolated port.	$Isolation(dB) = 10\log \frac{P_{in}}{P_{iso}}$
Phase Balance	The difference in phase angle between the two output ports.	Phase at coupled port – Phase at direct port

*100% RF test is performed per spec definition for pin configuration 1 and port 1 (input port) is connected to pin1, port 2 (isolated port) is connected to pin 3, port 3 (direct port) is connected to pin 4 and port 4 (isolated) is connected to pin 6.

Mounting Configuration:

In order for Xinger surface mount components to work optimally, the proper impedance transmission lines must be used to connect to the RF ports. If this condition is not satisfied, insertion loss, Isolation and VSWR may not meet published specifications.

All of the Xinger components are constructed from organic PTFE based composites which possess excellent electrical and mechanical stability. Xinger components are compliant to a variety of ROHS and Green standards and ready for Pb-free soldering processes. Pads are Gold plated with a Nickel barrier.

An example of the PCB footprint used in the testing of these parts is shown below. In specific designs, the transmission line widths need to be adjusted to the unique dielectric coefficients and thicknesses as well as varying pick and place equipment tolerances.

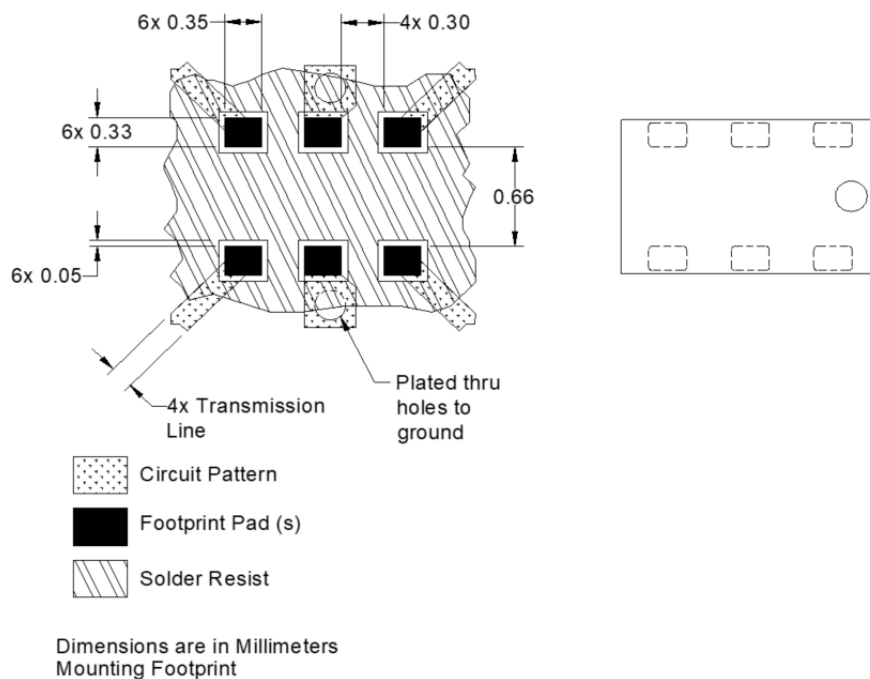

Packaging and Ordering Information

Parts are available in reel and are packaged per EIA 481-D. Parts are oriented in tape and reel as shown below. Minimum order quantities are 4000 per reel.

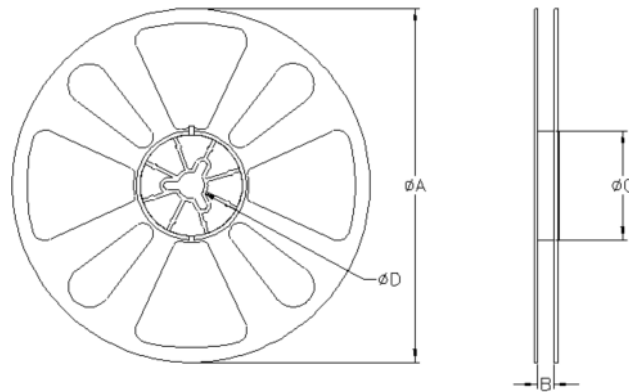
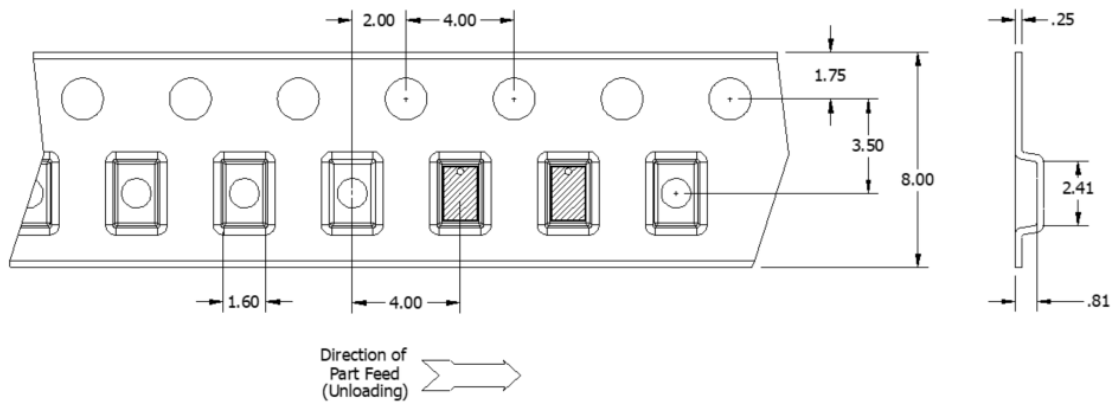

QUANTITY/REEL	REEL DIMENSIONS mm	
4000	ϕA	177.80
	B	8.00
	ϕC	50.80
	ϕD	13.00