

STN202XXXUXXX

TVS Diode array ESD suppressor

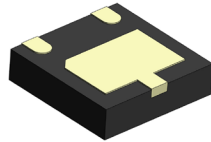

Product features

- Low leakage current
- Low clamping voltage
- Solid-state silicon-avalanche technology
- Meets moisture sensitivity level (MSL) 3
- Molding compound flammability rating: UL 94V-0
- Termination finish: Tin plating

Applications

- Power lines
- DC Fast charging
- Microprocessors based equipment
- Notebooks, desktops, and servers
- Cellular handsets and accessories
- Portable electronics and peripherals

Environmental compliance and general specifications

- IEC61000-4-2 (ESD)
 - Up to ± 30 kV (air)
 - Up to ± 30 kV (contact)
- IEC61000-4-5 (Lightning) Up to 240 A (8/20 μ s)



Ordering part number

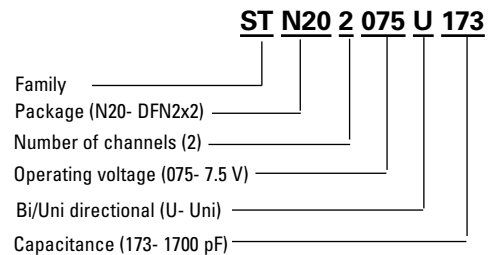

Pin out/functional diagram

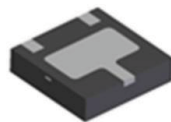

DFN2x2-3L



Circuit Diagram

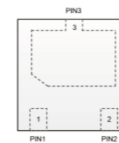

Pin Configuration

Absolute maximum ratings

(+25 °C, RH=45%-75%, unless otherwise noted)

Parameter	Symbol	Value				Unit
		STN202075U173	STN202120U952	STN202150U952	STN202240U752	
Peak pulse power dissipation on 8/20 μs waveform	P_{PP}	5000	4500	4500	6000	W
ESD per IEC 61000-4-2 (Air)	V_{ESD}	+/-30	+/-30	+/-30	+/-30	kV
ESD per IEC 61000-4-2 (Contact)		+/-30	+/-30	+/-30	+/-30	
Lead soldering temperature	T_L	+260 (10 seconds)	+260 (10 seconds)	+260 (10 seconds)	+260 (10 seconds)	°C
Operating junction temperature range	T_J	-55 to +125	-55 to +125	-55 to +125	-55 to +125	°C
Storage temperature range	T_{STG}	-55 to +150	-55 to +150	-55 to +150	-55 to +150	°C

Electrical characteristics

(+25 °C)

STN202075U173

Parameter	Test condition	Minimum	Typical	Maximum	Symbol (Units)
Reverse working voltage	-	-	-	7.5	V_{RWM} (V)
Reverse breakdown voltage	$I_T = 1$ mA	8	9	10	V_{BR} (V)
Reverse leakage current	$V_{RWM} = 7.5$ V	-	-	1	I_R (μA)
Clamping voltage	$I_{PP} = 50$ A, $t_p = 8/20$ μs	-	13	15.5	V_C (V)
	$I_{PP} = 100$ A, $t_p = 8/20$ μs	-	15.5	18.5	V_C (V)
	$I_{PP} = 240$ A, $t_p = 8/20$ μs	-	21	25	V_C (V)
Junction capacitance	$V_{RWM} = 0$ V, $f = 1$ MHz	1600	1700	2200	C_J (pF)

STN202120U952

Parameter	Test condition	Minimum	Typical	Maximum	Symbol (Units)
Reverse working voltage	-	-	-	12	V_{RWM} (V)
Reverse breakdown voltage	$I_T = 1$ mA	13	14.5	16	V_{BR} (V)
Reverse leakage current	$V_{RWM} = 12$ V	-	-	1	I_R (μA)
Clamping voltage	$I_{PP} = 50$ A, $t_p = 8/20$ μs	-	-	22	V_C (V)
	$I_{PP} = 100$ A, $t_p = 8/20$ μs	-	-	25	V_C (V)
	$I_{PP} = 180$ A, $t_p = 8/20$ μs	-	-	32	V_C (V)
Junction capacitance	$V_{RWM} = 0$ V, $f = 1$ MHz	900	950	1200	C_J (pF)

STN202150U952

Parameter	Test condition	Minimum	Typical	Maximum	Symbol (Units)
Reverse working voltage	-	-	-	15	V_{RWM} (V)
Reverse breakdown voltage	$I_T = 1$ mA	16	17.5	19	V_{BR} (V)
Reverse leakage current	$V_{RWM} = 15$ V	-	-	1	I_R (μA)
Clamping voltage	$I_{PP} = 50$ A, $t_p = 8/20$ μs	-	22	25	V_C (V)
	$I_{PP} = 100$ A, $t_p = 8/20$ μs	-	25	27	V_C (V)
	$I_{PP} = 150$ A, $t_p = 8/20$ μs	-	29	35	V_C (V)
Junction capacitance	$V_{RWM} = 0$ V, $f = 1$ MHz	-	950	1200	C_J (pF)

STN202240U752

Parameter	Test condition	Minimum	Typical	Maximum	Symbol (Units)
Reverse working voltage	-	-	-	24	V_{RWM} (V)
Reverse breakdown voltage	$I_T = 1$ mA	26	27	30	V_{BR} (V)
Reverse leakage current	$V_{RWM} = 24$ V	-	-	1	I_R (μ A)
Clamping voltage	$I_{PP} = 50$ A, $t_p = 8/20$ μ s	-	45	50	V_C (V)
	$I_{PP} = 120$ A, $t_p = 8/20$ μ s	-	52	60	V_C (V)
Junction capacitance	$V_{RWM} = 0$ V, $f = 1$ MHz	-	750	-	C_J (pF)

Mechanical parameters, pad layout- mm

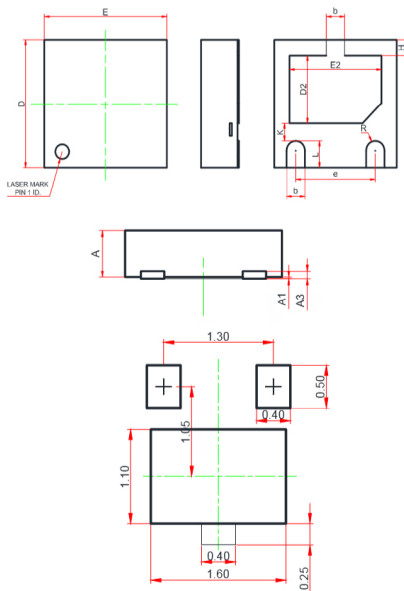

Land pattern

Dimension	Minimum	Typical	Maximum
A	0.51	0.55	0.60
A1	0.00	0.02	0.05
A3		0.15 REF	
b	0.25	0.30	0.35
D	1.90	2.00	2.10
E	1.90	2.00	2.10
D2	0.85	1.00	1.10
E2	1.35	1.50	1.60
e	1.20	1.30	1.40
H	0.20	0.25	0.30
K	0.20	0.30	0.40
L	0.35	0.40	0.45
R	0.15	-	-

Part marking

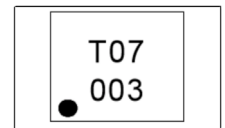

(STN202075U173)

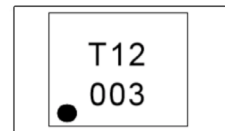

(STN202120U952)

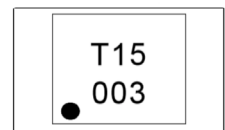

(STN202150U952)

Packaging information (mm)

Drawing not to scale.

Supplied in tape and reel packaging, 3,000 parts per 7" diameter reel (EIA-481 compliant)

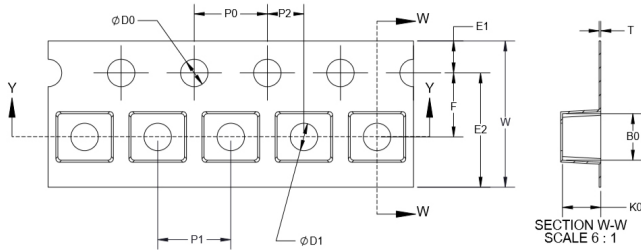

W	8.00
F	3.50
E1	1.75
E2	N/A
P0	4.00
P1	4.00
P2	2.00
ØD0	1.55
ØD1	N/A
A0	2.20
B0	2.20
K0	0.70
T	N/A

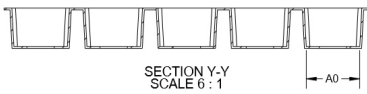

Cavity Shape For Reference Only

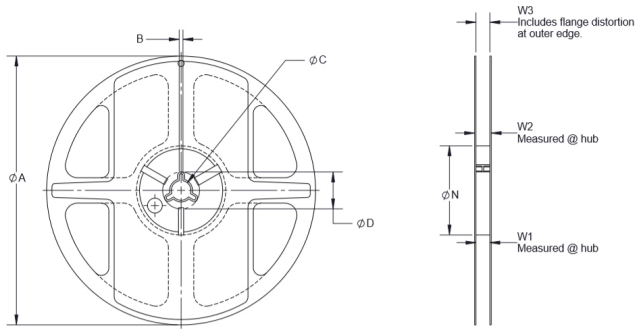

Shape & Appearance For Reference Only

A	178.00
B	N/A
C	13.00
D	N/A
N	54.40
W1	9.50
W2	12.30
W3	N/A

Ratings and V-I characteristic curves (+25 °C unless otherwise noted)

V- I curve characteristics (Uni-directional)

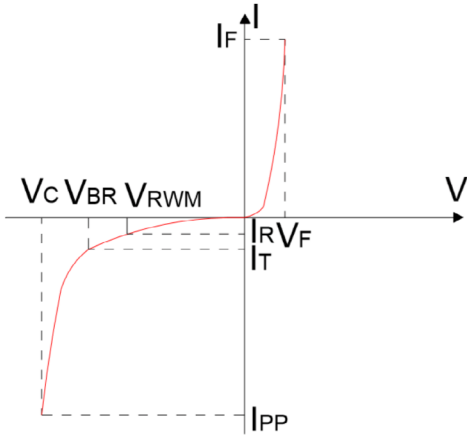

Pulse waveform (8/20 μ s)

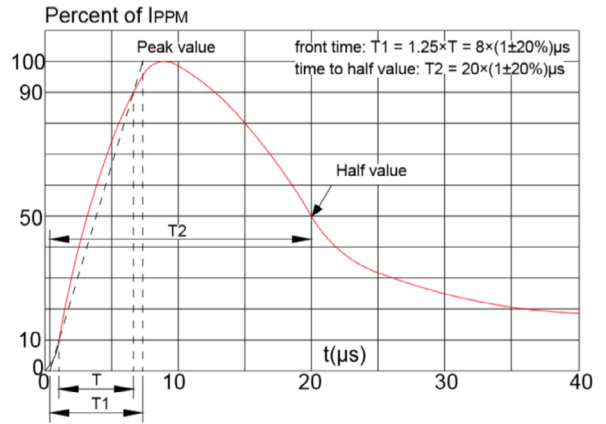

Pulse derating curve

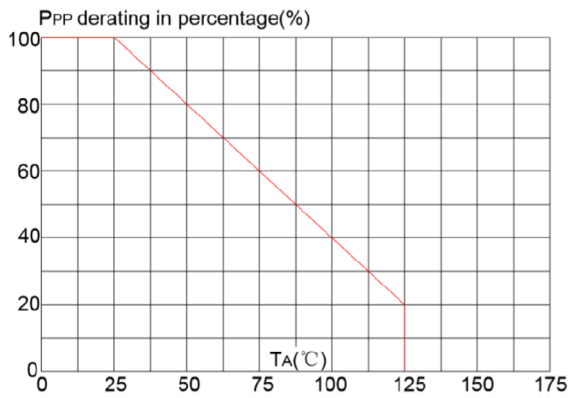

ESD waveform

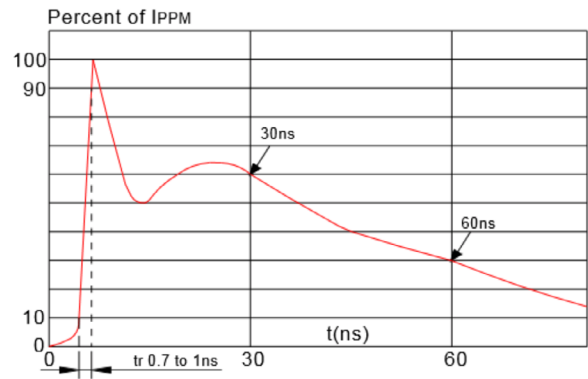

Solder reflow profile

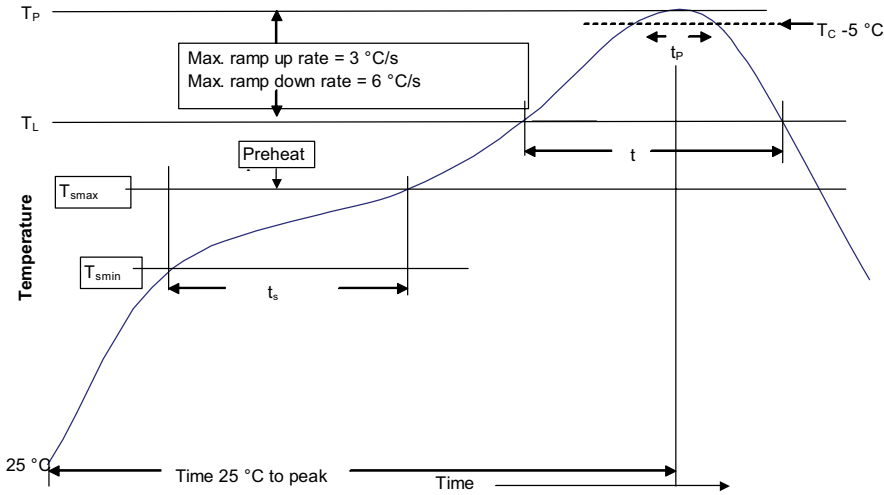

Table 1 - Standard SnPb solder (T_C)

Package thickness	Volume mm ³ <350	Volume mm ³ ≥350
<2.5 mm	235 °C	220 °C
≥2.5 mm	220 °C	220 °C

Table 2 - Lead (Pb) free solder (T_C)

Package thickness	Volume mm ³ <350	Volume mm ³ 350 - 2000	Volume mm ³ >2000
<1.6 mm	260 °C	260 °C	260 °C
1.6 – 2.5 mm	260 °C	250 °C	245 °C
>2.5 mm	250 °C	245 °C	245 °C

Reference J-STD-020

Profile feature	Standard SnPb solder	Lead (Pb) free solder
Preheat and soak	<ul style="list-style-type: none"> Temperature min. (T_{Amin}) Temperature max. (T_{Amax}) Time (T_{Amin} to T_{Amax}) (t_s) 	<ul style="list-style-type: none"> 100 °C 150 °C 60-120 seconds
Ramp up rate T _L to T _P	3 °C/ second max.	3 °C/ second max.
Liquidous temperature (T _L) Time (t _L) maintained above T _L	<ul style="list-style-type: none"> 183 °C 60-150 seconds 	<ul style="list-style-type: none"> 217 °C 60-150 seconds
Peak package body temperature (T _P)*	Table 1	Table 2
Time (t _P)* within 5 °C of the specified classification temperature (T _C)	20 seconds*	30 seconds*
Ramp-down rate (T _P to T _L)	6 °C/ second max.	6 °C/ second max.
Time 25 °C to peak temperature	6 minutes max.	8 minutes max.

* Tolerance for peak profile temperature (T_P) is defined as a supplier minimum and a user maximum.

Life Support Policy: Eaton does not authorize the use of any of its products for use in life support devices or systems without the express written approval of an officer of the Company. Life support systems are devices which support or sustain life, and whose failure to perform, when properly used in accordance with instructions for use provided in the labeling, can be reasonably expected to result in significant injury to the user.

Eaton reserves the right, without notice, to change design or construction of any products and to discontinue or limit distribution of any products. Eaton also reserves the right to change or update, without notice, any technical information contained in this bulletin.

Eaton
Electronics Division
1000 Eaton Boulevard
Cleveland, OH 44122
United States
Eaton.com/electronics

© 2021 Eaton
All Rights Reserved
Printed in USA
Publication No. 11135
May 2021

Eaton is a registered trademark.

All other trademarks are property of their respective owners.

Follow us on social media to get the latest product and support information.

