

1- stage filter for 3-phase systems



See below:

Approvals and Compliances

Description

- 3 phase line filter with standard attenuation
- Available as high voltage filter (up to 520 VAC)

Applications

- Voltage rating 480 and 520 VAC for world wide acceptance
- Protection against interference voltage from the mains
- For photovoltaic systems and industrial applications
- Suitable for use in equipment according to IEC/UL 62368-1

References

We recommend for new applications the type [FMAC NEO](#); [FMBC EP](#)

Weblinks

[pdf data sheet](#), [html datasheet](#), [General Product Information](#), [Approvals](#), [Distributor-Stock-Check](#), [Detailed request for product](#), [Microsite](#)

Technical Data

| | | |
|---------------------|--|-------------|
| Rated Current | 6 - 1100A | |
| Rated voltage | 480/520 VAC, 50/60 Hz | |
| Approval for | 6 - 1100A @ Ta 40 (75) °C / 480 VAC; 50Hz | |
| Overload Current | 1.5 x Ir for 1 minute, per hour | |
| Leakage Current | industrial < 15mA (440V / 50 Hz) | |
| Dielectric Strength | 480 VAC: 2.25 kVDC between L-L 3 kVDC between L-PE | |
| | 520 VAC: 2.25 kVDC between L-L 4 kVDC between L-PE Test voltage (2 sec) | |
| | Number of Filter Stages | 1-stage |
| | Weight | 0.9 - 47 kg |
| Material: Housing | Metal | |
| Sealing Compound | UL 94V-0 | |

| | |
|-----------------------|---|
| Mounting | Screw-on mounting on chassis, from top |
| Terminal | Screw clamps |
| Operating Temperature | -25 °C to 100 °C |
| Climatic Category | 25/100/21 acc. to IEC 60068-1 |
| Degree of Protection | IP20 acc. to IEC 60529 |
| Protection Class | Suitable for appliances with protection class I acc. to IEC 61140 |
| MTBF | > 200'000h acc. to MIL-HB-217 F |

Approvals and Compliances



Detailed information on product approvals, code requirements, usage instructions and detailed test conditions can be looked up in [Details about Approvals](#)

SCHURTER products are designed for use in industrial environments. They have approvals from independent testing bodies according to national and international standards. Products with specific characteristics and requirements such as required in the automotive sector according to IATF 16949, medical technology according to ISO 13485 or in the aerospace industry can be offered exclusively with customer-specific, individual agreements by SCHURTER.

Approvals

The approval mark is used by the testing authorities to certify compliance with the safety requirements placed on electronic products.

Approval Reference Type: FMAC

| Approval Logo | Certificates | Certification Body | Description |
|---|-------------------------------|--------------------|---|
|  | VDE Approvals | VDE | Certificate Number: 40004666 + 40004673 |
|  | UL Approvals | UL | UR File Number: E72928 |

Product standards

Product standards that are referenced

| Organization | Design | Standard | Description |
|--|-----------------------|-----------|--|
|  | Designed according to | IEC 60939 | Passive filters for suppressing electromagnetic interference |
|  | Designed according to | UL 1283 | Electromagnetic interference filters |





Application standards

Application standards where the product can be used

| Organization | Design | Standard | Description |
|--|--------------------------------|----------------|---|
|  | Designed for applications acc. | IEC/UL 62368-1 | Audio/video, information and communication technology equipment - Part 1: Safety requirements |

Compliances

The product complies with following Guide Lines

| Identification | Details | Initiator | Description |
|---|--|-------------|---|
|  | CE declaration of conformity | SCHURTER AG | The CE marking declares that the product complies with the applicable requirements laid down in the harmonisation of Community legislation on its affixing in accordance with EU Regulation 765/2008. |
|  | UKCA declaration of conformity | SCHURTER AG | The UKCA marking declares that the product complies with the applicable requirements laid down in the British Amendment of Regulation (EC) 765/2008. |
|  | RoHS | SCHURTER AG | Directive RoHS 2011/65/EU, Amendment (EU) 2015/863 |
|  | China RoHS | SCHURTER AG | The law SJ / T 11363-2006 (China RoHS) has been in force since 1 March 2007. It is similar to the EU directive RoHS. |
|  | REACH | SCHURTER AG | On 1 June 2007, Regulation (EC) No 1907/2006 on the Registration, Evaluation, Authorization and Restriction of Chemicals 1 (abbreviated as "REACH") entered into force. |

Dimension [mm]

Case 24-3

Case 31-3

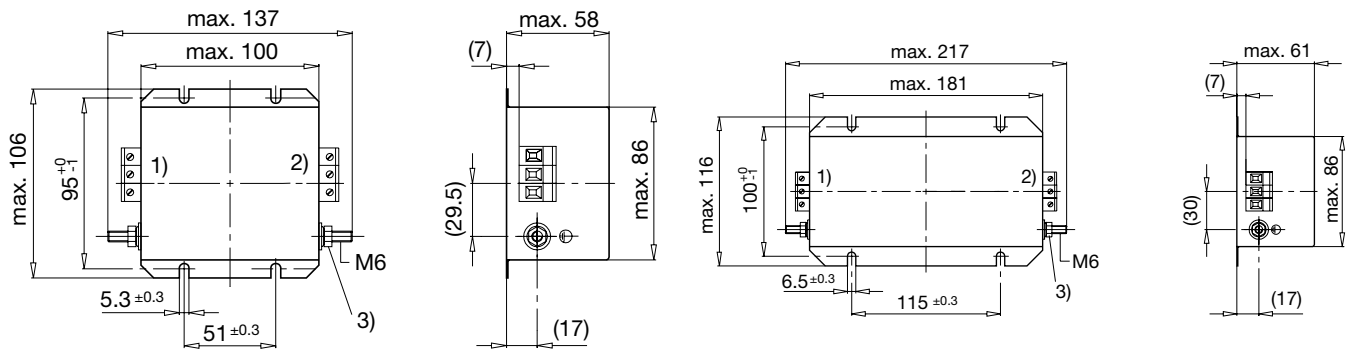

- 1) Line
- 2) Load
- 3) Nut torque 3...4 Nm

Case 32-3

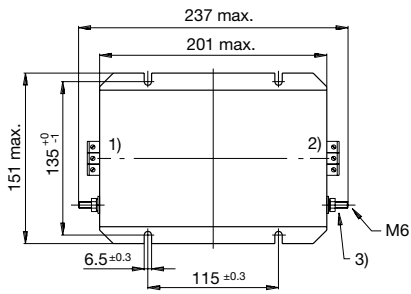

Case 32-7

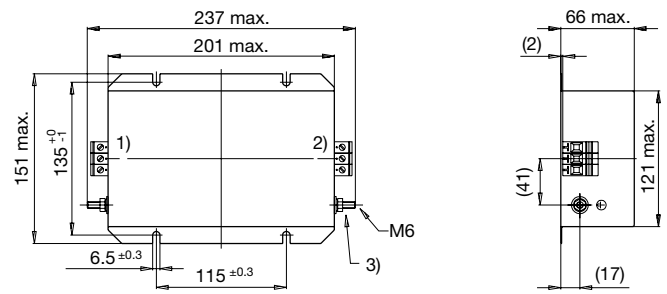

Case 32-C

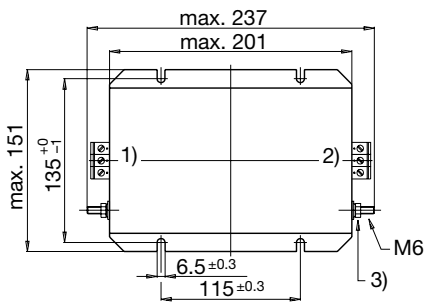

Case 34-3

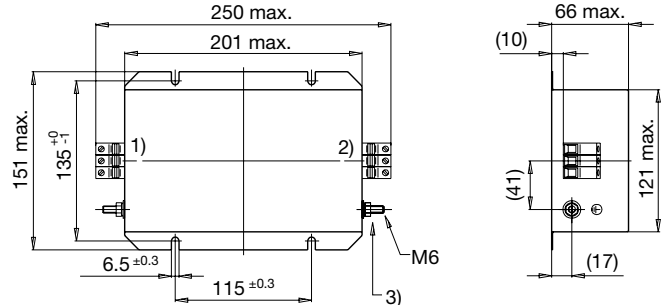

Case 34-C

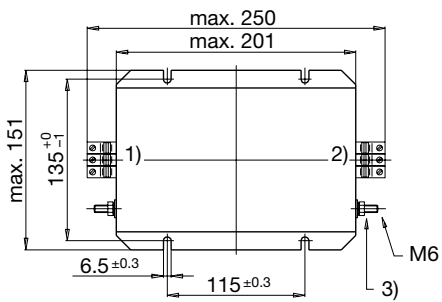

Case 37-3

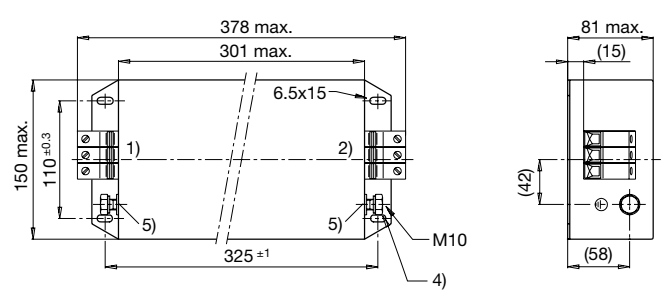

Case 53-3

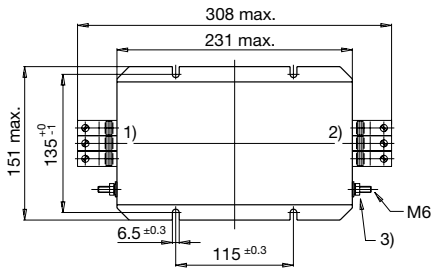

Case 54-3

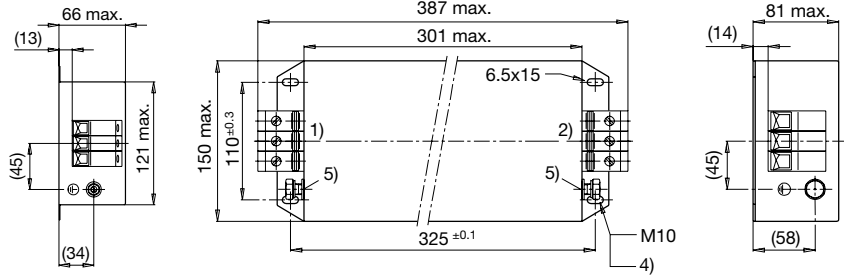

- 1) Line
- 2) Load
- 3) Tightening torque 3...4 Nm
- 4) Tightening torque 10...17 Nm
- 5) Do not unscrew lock-nut

Case 55-3

Case 56-3

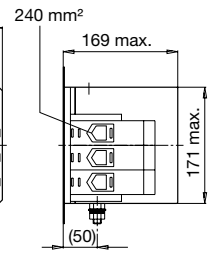
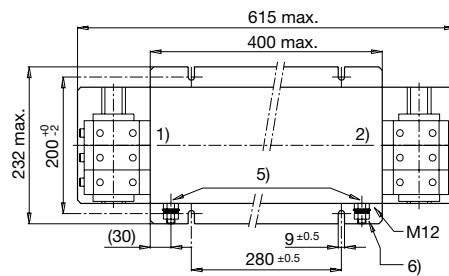
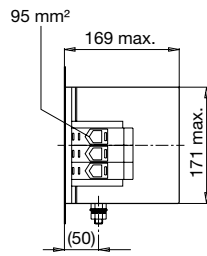
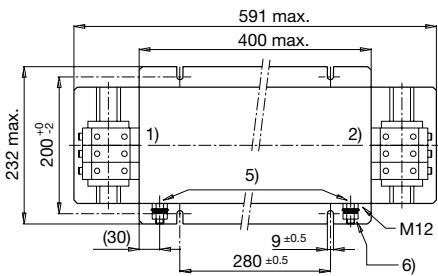

Case 57

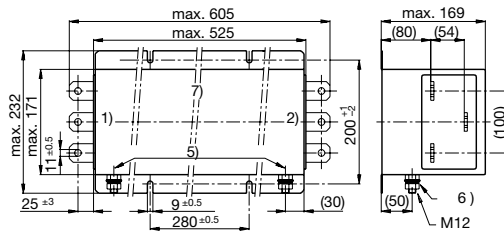

Case 74

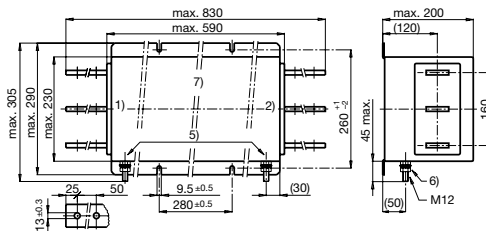

- 1) Line
- 2) Load
- 5) Do not unscrew lock-nut
- 6) Tightening torque 14...30 Nm
- 7) Current plates 720 mm² (60x12)

Technical data to the filter components

| Rated Current @ Tu 40°C (75°C) [A] | Characteristic | Rated Voltage [VAC] | L [mH] | C1 [μF] | C2 [μF] | C3 [nF] | C4 [nF] | C5 [μF] | C6 [μF] | R1 [MΩ] | R2 [MΩ] | R3 [MΩ] | R4 [MΩ] |
|---------------------------------------|-----------------------|---------------------|--------|---------|---------|---------|---------|---------|---------|---------|---------|---------|---------|
| 6 (6) | Excellent attenuation | 480 | 10 | 1.0 | - | 100 | 10 | 2.2 | - | - | - | 1 | 1 |
| 8 (5) | Excellent attenuation | 480 | 10 | 1.0 | - | 100 | 10 | 2.2 | - | - | - | 1 | 1 |
| 16 (10) | Excellent attenuation | 480 | 6 | 1.0 | - | 100 | 10 | 2.2 | - | - | - | 1 | 1 |
| 16 (C) | High voltage filter | 520 | 6 | 1.5 | - | 50 | 11 | 1.5 | - | 2 | 1 | 1 | 2 |
| 16 (10) | Excellent attenuation | 480 | 6 | 1.0 | - | 100 | 10 | 2.2 | - | - | - | 1 | 1 |
| 25 (15) | Excellent attenuation | 480 | 3 | 4.4 | 1 | 10 | 47 | 4.4 | 1 | 2.2 | 1 | 1 | 2.2 |
| 25 (14) | High attenuation | 480 | 2.4 | 4.4 | 1 | 10 | 47 | 4.4 | 1 | 2.2 | - | 1 | 2 |
| 25 (C) | High voltage filter | 520 | 3 | 3 | 1.1 | 50 | 11 | 3 | 1.1 | 2 | 1 | 1 | 2 |
| 36 (20) | High attenuation | 480 | 1.5 | 4.4 | 1 | 10 | 47 | 4.4 | 1 | 2.2 | - | 1 | 2 |
| 36 (C) | High voltage filter | 520 | 2 | 3 | 1.1 | 50 | 11 | 3 | 1.1 | 2 | 1 | 1 | 2 |
| 50 (32) | Excellent attenuation | 480 | 1 | 4.4 | 1 | 10 | 100 | 4.4 | 1 | 2.2 | 1 | 1 | 2.2 |
| 50 (30) | High attenuation | 480 | 1 | 4.4 | 1 | 10 | 100 | 4.4 | 1 | 2.2 | - | 1 | 2 |
| 50 (C) | High voltage filter | 520 | 1 | 3 | 1.1 | 50 | 11 | 3 | 1.1 | 2 | 1 | 1 | 2 |
| 64 (37) | High attenuation | 480 | 0.6 | 4.4 | 1 | 10 | 100 | 4.4 | 1 | 2.2 | - | 1 | 2 |
| 80 (45) | Excellent attenuation | 480 | 1 | 6.6 | 1 | 47 | 100 | 6.6 | 1 | 2.2 | 1 | 1 | 2.2 |
| 80 (C) | High voltage filter | 520 | 1 | 4.5 | 1.1 | 50 | 50 | 4.5 | 1.1 | 2 | 1 | 1 | 2 |
| 64 (37) | Excellent attenuation | 480 | 0.6 | 4.4 | 1 | 10 | 100 | 4.4 | 1 | 2.2 | 1 | 1 | 2.2 |
| 64 (C) | High voltage filter | 520 | 0.6 | 3 | 1.1 | 50 | 11 | 3 | 1.1 | 2 | 1 | 1 | 2 |
| 110 (70) | Excellent attenuation | 480 | 0.7 | 6.6 | 1 | 47 | 100 | 6.6 | 1 | 2.2 | 1 | 1 | 2.2 |
| 110 (C) | High voltage filter | 520 | 0.7 | 4.5 | 1.1 | 50 | 50 | 4.5 | 1.1 | 2 | 1 | 1 | 2 |
| 180 (C) | Excellent attenuation | 480 | 0.4 | 6.6 | 1 | 47 | 100 | 6.6 | 1 | 2.2 | 1 | 1 | 2.2 |
| 180 (C) | High voltage filter | 520 | 0.4 | 4.5 | 1.1 | 50 | 50 | 4.5 | 1.1 | 2 | 1 | 1 | 2 |
| 250 (C) | Excellent attenuation | 480 | 0.3 | 11 | 1 | 100 | 100 | 11 | 1 | 2.2 | 0.5 | 0.5 | 2.2 |
| 250 (C) | High voltage filter | 520 | 0.3 | 7.5 | 1.1 | 50 | 50 | 7.5 | 1.1 | 2 | 1 | 1 | 2 |
| 340 (C) | Excellent attenuation | 480 | 0.2 | 11 | 1 | 100 | 100 | 22 | 1 | 2.2 | 0.33 | 0.33 | 2.2 |
| 340 (C) | High voltage filter | 520 | 0.2 | 7.5 | 1.1 | 50 | 50 | 15 | 1.1 | 2 | 1 | 1 | 2 |
| 450 (C) | Excellent attenuation | 480 | 0.2 | 11 | 1 | 100 | 100 | 22 | 1 | 2.2 | 0.33 | 0.33 | 2.2 |
| 550 (C) | Excellent attenuation | 480 | 0.2 | 11 | 1 | 100 | 100 | 22 | 1 | 2.2 | 0.33 | 0.33 | 2.2 |
| 1100 (C) | High voltage filter | 520 | 0.12 | 11 | 1.1 | 50 | - | 22 | 1.1 | 2 | 0.5 | 0.25 | 2 |

Diagrams

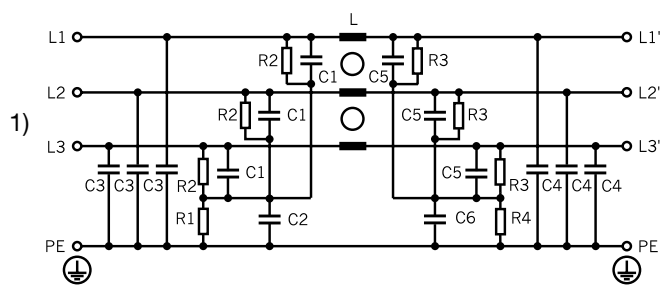

1) Line

Derating Curves

Permissible Working Current as a Function of Ambient Temperature

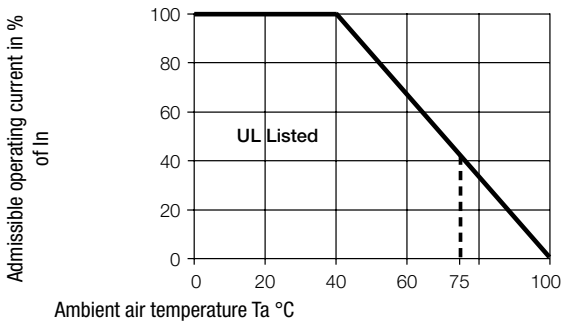

Attenuation Loss

--- 50Ω differential mode ___ 50Ω common mode

Industrial version

6A (FMAC-0924-0610)

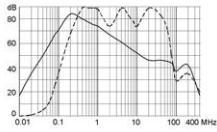

8A (FMAC-0931-0810)

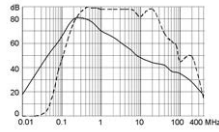

16A (FMAC-0931-1610)
16A (FMAC-0932-1610)

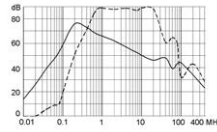

16A (FMAC-0931-1612I)

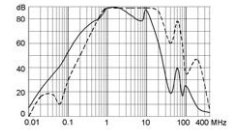

25A (FMAC-0932-2510)

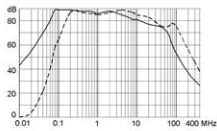

25A (FMAC-0932-2510L)

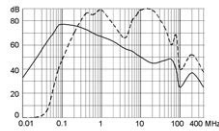

25A (FMAC-0932-2512I)

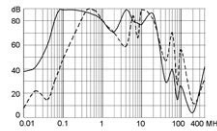

36A (FMAC-0934-3610)

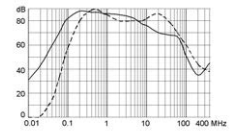

36A (FMAC-0932-3610L)

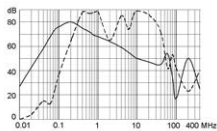

36A (FMAC-0932-3612I)

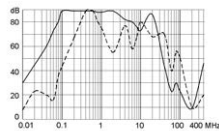

50A (FMAC-0934-5010)

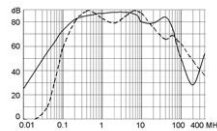

50A (FMAC-0934-5010L)

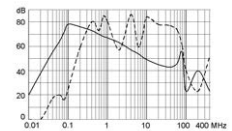

50A (FMAC-0934-5012I)

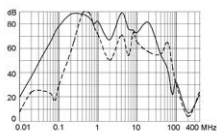

64A (FMAC-0953-6410)

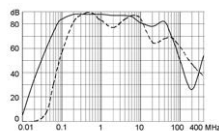

64A (FMAC-0934-6410L)

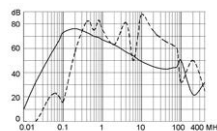

64A (FMAC-0953-6412I)

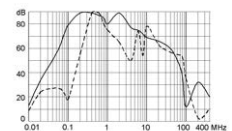

80A (FMAC-0937-8010)

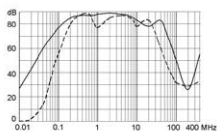

80A (FMAC-0937-8012I)

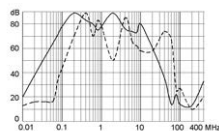

110A (FMAC-0954-H110)

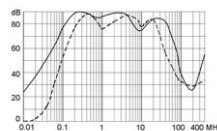

110A (FMAC-0954-H112I)

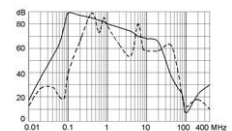

180A (FMAC-0955-H210)

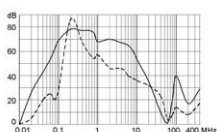

180A (FMAC-0955-H212I)

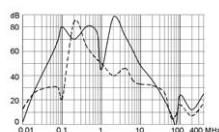

250A (FMAC-0956-H310)

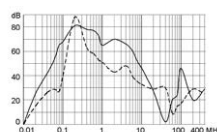

250A (FMAC-0956-H312I)

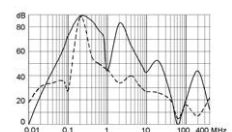

340A (FMAC-0956-H410)

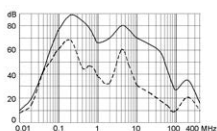

340A (FMAC-0956-H412I)

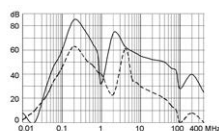

450A (FMAC-0957-H550)

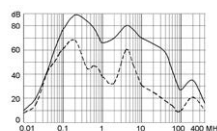

550A (FMAC-0957-H650)

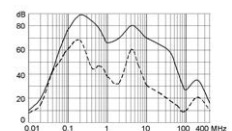

1100A (FMAC-0974-K152I)

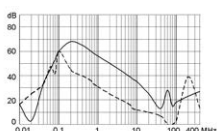

All Variants

| Rated Current @ Tu 40°C (75°C) [A] | Characteristic | Rated Voltage [VAC] | Tripped Power Dissipation [W] | Leakage Current [mA] @ 440V _r | Contact Resistance [mΩ] | Weight [kg] | Screw clamps [mm ²] 2) | Housing | Order Number |
|------------------------------------|-----------------------|---------------------|-------------------------------|--|-------------------------|-------------|------------------------------------|---------|-----------------|
| 6 (6) | Excellent attenuation | 480 | 2.48 | 1.3 | 23 | 0.9 kg | 4 | 24-3 | FMAC-0924-0610 |
| 8 (5) | Excellent attenuation | 480 | 5.38 | 1.3 | 28 | 1.8 kg | 4 | 31-3 | FMAC-0931-0810 |
| 16 (10) | Excellent attenuation | 480 | 8.83 | 1.3 | 11.5 | 1.8 kg | 4 | 31-3 | FMAC-0931-1610 |
| 16 (C) | High voltage filter | 520 | 8.83 | 0.7 | 11.5 | 1.8 kg | 4 | 31-3 | FMAC-0931-1612I |
| 16 (10) | Excellent attenuation | 480 | 8.83 | 1.3 | 11.5 | 2.8 kg | 4 | 32-3 | FMAC-0932-1610 |
| 25 (15) | Excellent attenuation | 480 | 8.25 | 8.4 | 4.4 | 3.4 kg | 6 | 32-7 | FMAC-0932-2510 |
| 25 (14) | High attenuation | 480 | 9.86 | 8.4 | 5.26 | 3.5 kg | 4 | 32-7 | FMAC-0932-2510L |
| 25 (C) | High voltage filter | 520 | 8.25 | 8.6 | 4.4 | 3.35 kg | 6 | 32-7 | FMAC-0932-2512I |
| 36 (20) | High attenuation | 480 | 10.55 | 8.4 | 2.71 | 3.75 kg | 6 | 32-C | FMAC-0932-3610L |
| 36 (20) | Excellent attenuation | 480 | 12.91 | 8.6 | 3.32 | 3.5 kg | 6 | 34-3 | FMAC-0934-3610 |
| 36 (C) | High voltage filter | 520 | 12.91 | 8.6 | 3.32 | 3.3 kg | 6 | 34-3 | FMAC-0934-3612I |
| 50 (32) | Excellent attenuation | 480 | 9.75 | 9.0 | 1.3 | 3.4 kg | 6 | 34-3 | FMAC-0934-5010 |
| 50 (30) | High attenuation | 480 | 12.63 | 9.0 | 1.68 | 3.6 kg | 6 | 34-C | FMAC-0934-5010L |
| 50 (C) | High voltage filter | 520 | 9.75 | 9.0 | 1.3 | 3.35 kg | 6 | 34-3 | FMAC-0934-5012I |
| 64 (37) | High attenuation | 480 | 18.23 | 8.6 | 1.48 | 4.2 kg | 6 | 34-C | FMAC-0934-6410L |
| 80 (45) | Excellent attenuation | 480 | 22.6 | 9.7 | 1.17 | 7 kg | 25 | 37-3 | FMAC-0937-8010 |
| 80 (C) | High voltage filter | 520 | 22.6 | 9.7 | 1.17 | 7.28 kg | 25 | 37-3 | FMAC-0937-8012I |
| 64 (37) | Excellent attenuation | 480 | 13.52 | 9.0 | 1.1 | 3.9 kg | 25 | 53-3 | FMAC-0953-6410 |
| 64 (C) | High voltage filter | 520 | 13.52 | 9.0 | 1.1 | 3.8 kg | 25 | 53-3 | FMAC-0953-6412I |
| 110 (70) | Excellent attenuation | 480 | 27.23 | 9.7 | 0.75 | 7.5 kg | 50 | 54-3 | FMAC-0954-H110 |
| 110 (C) | High voltage filter | 520 | 27.23 | 9.7 | 0.75 | 7.45 kg | 50 | 54-3 | FMAC-0954-H112I |
| 180 (C) | Excellent attenuation | 480 | 36 | 9.7 | 0.37 | 22 kg | 95 | 55-3 | FMAC-0955-H210 |
| 180 (C) | High voltage filter | 520 | 36 | 9.7 | 0.37 | 23 kg | 95 | 55-3 | FMAC-0955-H212I |
| 250 (C) | Excellent attenuation | 480 | 36 | 10.5 | 0.2 | 23.7 kg | 240 | 56-3 | FMAC-0956-H310 |
| 250 (C) | High voltage filter | 520 | 36 | 9.1 | 0.2 | 25 kg | 240 | 56-3 | FMAC-0956-H312I |
| 340 (C) | Excellent attenuation | 480 | 45 | 10.5 | 0.13 | 27 kg | 240 | 56-3 | FMAC-0956-H410 |
| 340 (C) | High voltage filter | 520 | 45 | 5.6 | 0.13 | 30 kg | 240 | 56-3 | FMAC-0956-H412I |
| 450 (C) | Excellent attenuation | 480 | 40 | 10.5 | 0.06 | 33 kg | (B) | 57 | FMAC-0957-H550 |
| 550 (C) | Excellent attenuation | 480 | 45 | 10.5 | 0.046 | 32 kg | (B) | 57 | FMAC-0957-H650 |
| 1100 (C) | High voltage filter | 520 | 80 | 9.5 | 0.022 | 47 kg | (A) | 74 | FMAC-0974-K152I |

Most Popular.

Availability for all products can be searched real-time: <https://www.schurter.com/en/Stock-Check/Stock-Check-SCHURTER>

6A version: packing unit 2 pcs.

(A): Connecting straps for M12

(B): Connecting straps for M10

(C): Article without UL approval only VDE approval

1) Leakage current according IEC 60939-1

2) Maximum conductor cross section (wire gauge) to be used; a comparative table for AWG and mm² values can be found in the general product information <https://www.schurter.com/en/FAQ#10>

Packaging unit

1 Pcs