

CRYSTAL CLOCK OSCILLATORS (SMD · Ceramic Package)

RoHS compliant

CSX-750F (Low Voltage Ver.)

1,000pcs/reel

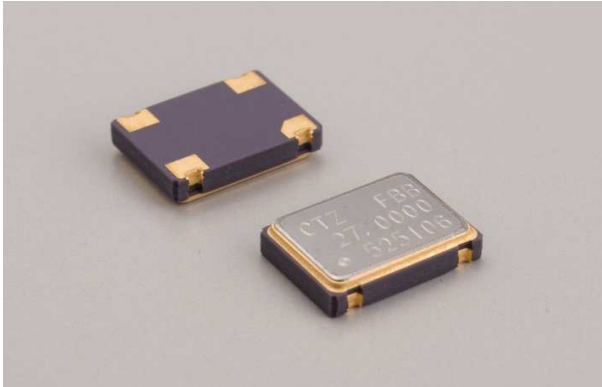

■ FEATURES

- Low current consumption type
- Frequency range : 1.0 ~ 39.9MHz
- External dimensions (mm)
L : 7.0 x W : 5.0 x H : 1.6
- Applications
Consumer products

■ DIMENSION [mm]

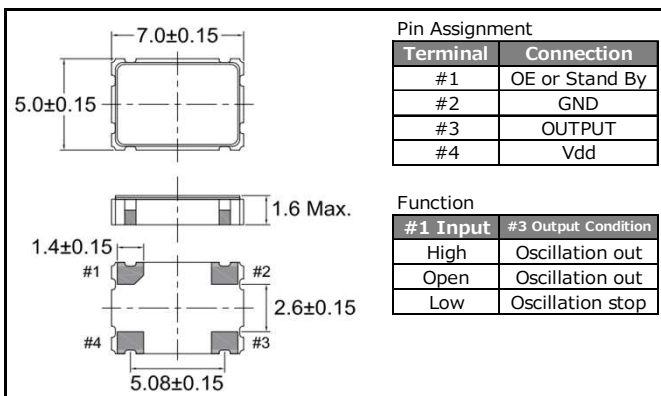

■ SOLDER PAD LAYOUT [mm]

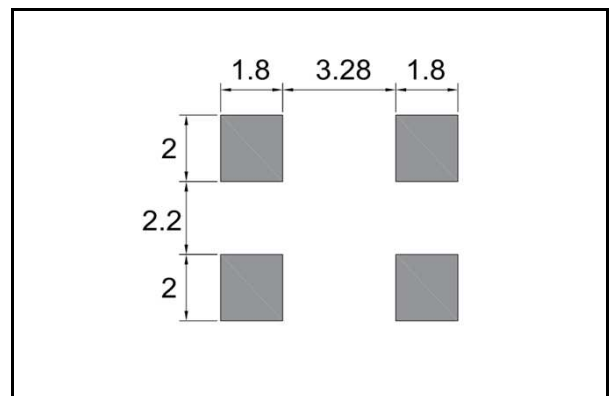

■ STANDARD SPECIFICATIONS

Item	Model	OE			
		STAND-BY	CSX-750FM (*)	CSX-750FH (*)	CSX-750FN (*)
Frequency Range			1.8432MHz~39.999MHz		
Supply Voltage			Vdd: 1.8V±0.2V	Vdd: 2.5V±0.2V	Vdd: 2.8V±0.2V
Frequency Stability		(*)	B: ±50ppm(-20°C ~ +70°C), C: ±100ppm(-20°C ~ +70°C) E: ±50ppm(-40°C ~ +85°C), F: ±100ppm(-40°C ~ +85°C)		
Operating Temperature Range			-20°C ~ +70°C / (-40°C ~ +85°C)		
Storage Temperature Range			-55°C ~ +125°C		
Current consumption			2.5mA Max.	3.0mA Max.	3.2mA Max.
Duty	TTL level (1.4V)		-		
	CMOS level (1/2 Vdd)		45~55%		
Output Voltage	V _{OH}		0.9Vdd Min.		
	V _{OL}		0.1Vdd Max.		
Output Load	TTL		-		
	CMOS		15pF Max.		
Rise and Fall Time			8 nsec Max.		
Start-up time			4 msec Max.		
Input Voltage	V _{IH}		0.8Vdd Min.		
	V _{IL}		0.2Vdd Max.		
Disable current			-		
Stand-by current			10 μA Max.		

■ PART NUMBERING SYSTEM

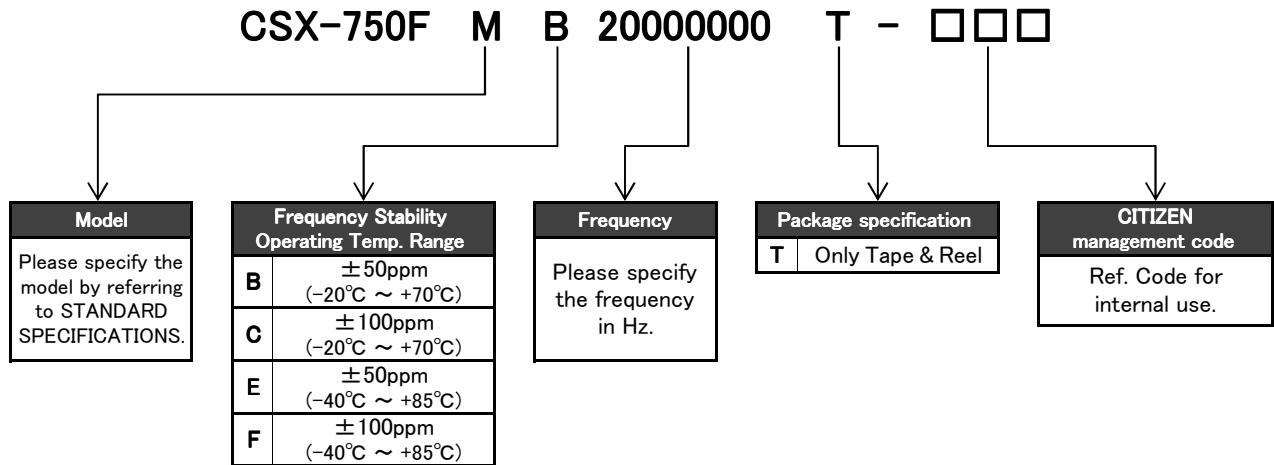

*Please contact us for specifications available.

■ Part Marking [standard]

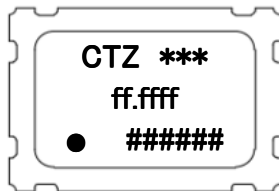

CTZ : Manufacture's ID Code

*** : Model

f : Frequency

: Production Lot No.

■ Reflow profile

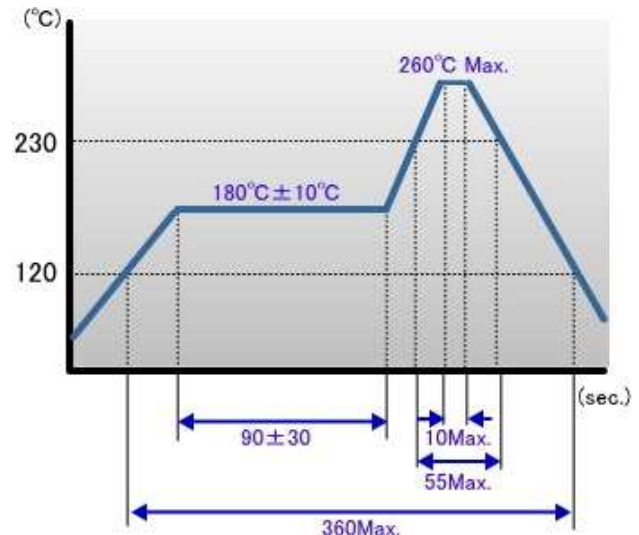

■ Packing

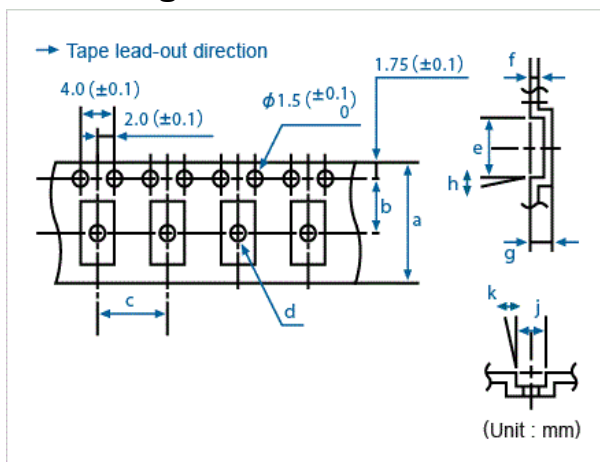

Conforming to JIS C 0806 TB1208NEIAJ and RC-1009B TE1208N

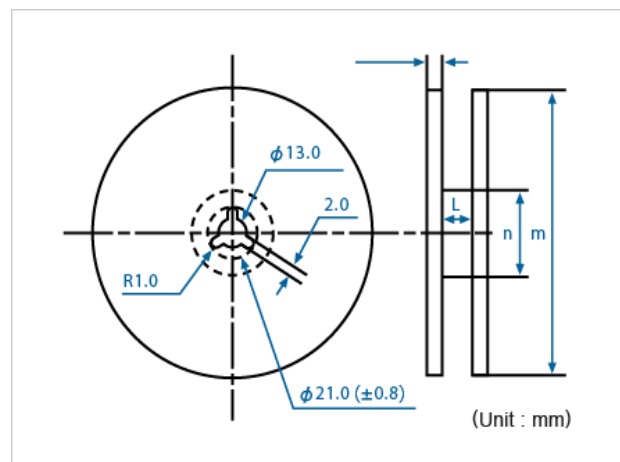

Conforming to JIS C 0806 R12R and EIAJ RC-1009B R15

Q'ty/reel	a	b	c	d (φ)	e	f	g	h	j	k	l	m (φ)	n (φ)
1,000	16.0	7.5	8.0	1.5	7.4	0.3	1.9	5°	5.4	5°	16.0	180	62

Product specifications are subject to change without notice.

Rev.2