



TAOGLAS®



Datasheet

Accura GNSS L1/L5 Stacked Patch Multi-Band Antenna

Part No:
GVLB258.A

Description:

Single Feed Stacked Patch Antenna for GNSS L1 / L5, GLONASS, BeiDou B1

Features:

Single Feed Stacked Patch Assembly

Covering Bands

- GPS L1 & L5
- BeiDou B1
- Galileo E1 & E5a
- GLONASS G1
- IRNSS L5

Pin Mount

Dimensions: 25*25*8.12mm

RoHS & REACH Compliant

1. Introduction	3
2. Specifications	4
3. Antenna Characteristics	5
4. Radiation Patterns	8
5. Mechanical Drawing	11
6. Footprint	12
7. Packaging	13
<hr/>	
Changelog	14

Taoglas makes no warranties based on the accuracy or completeness of the contents of this document and reserves the right to make changes to specifications and product descriptions at any time without notice. Taoglas reserves all rights to this document and the information contained herein. Reproduction, use or disclosure to third parties without express permission is strictly prohibited.



1. Introduction



The Taoglas Accura GVLB258.A, is a multi-band GPS, BeiDou/Compass and IRNSS, high-performance directional antenna for high precision GPS and BeiDou accuracy and fast positioning. It utilizes a 25*25*8mm advanced wide-band dual stacked ceramic patch antenna with optimized gain for GPS L1/L5, Galileo, GLONASS and BeiDou bands.

Typical Applications Include:

- RTK
- Navigation
- Wearables
- Security
- Transportation
- Autonomous Vehicles
- Agriculture

The GVLB258.A has been tuned and tested on a 70 x 70 mm ground plane and exhibits excellent radiation patterns. The GVLB258.A has been optimised to cover the bands required for the next generation of L1/L5 GNSS receivers that are currently on the market.

Patch antennas can be specifically tuned to customer-specific device environments, subject to NRE and MOQ. Contact your regional Taoglas customer support team to request these services or additional support to integrate and test this antenna's performance in your device.

2. Specifications

GNSS Frequency Bands Covered						
GPS	L1	L2	L5			
	■	□	■			
GLONASS	G1	G2	G3			
	■	□	□			
Galileo	E1	E5a	E5b	E6		
	■	■	□	□		
BeiDou	B1	B2a	B2b	B3		
	■	□	□	□		
QZSS (Regional)	L1	L2C	L5	L6		
	■	□	■	□		
IRNSS (Regional)	L5					
	■					
SBAS	L1/E1/B1	L5/B2a/E5a	G1	G2	G3	
	■	■	■	□	□	

■ GNSS Frequency Bands Covered. □ GNSS Frequency Bands Not Covered.

*SBAS systems: WASS(L1/L5), EGNOS(E1/E5a), SDCM(G1/G2/G3), SNAS(B1,B2a), GAGAN(L1/L5), QZSS(L1/L5), KAZZ(L1/L5).

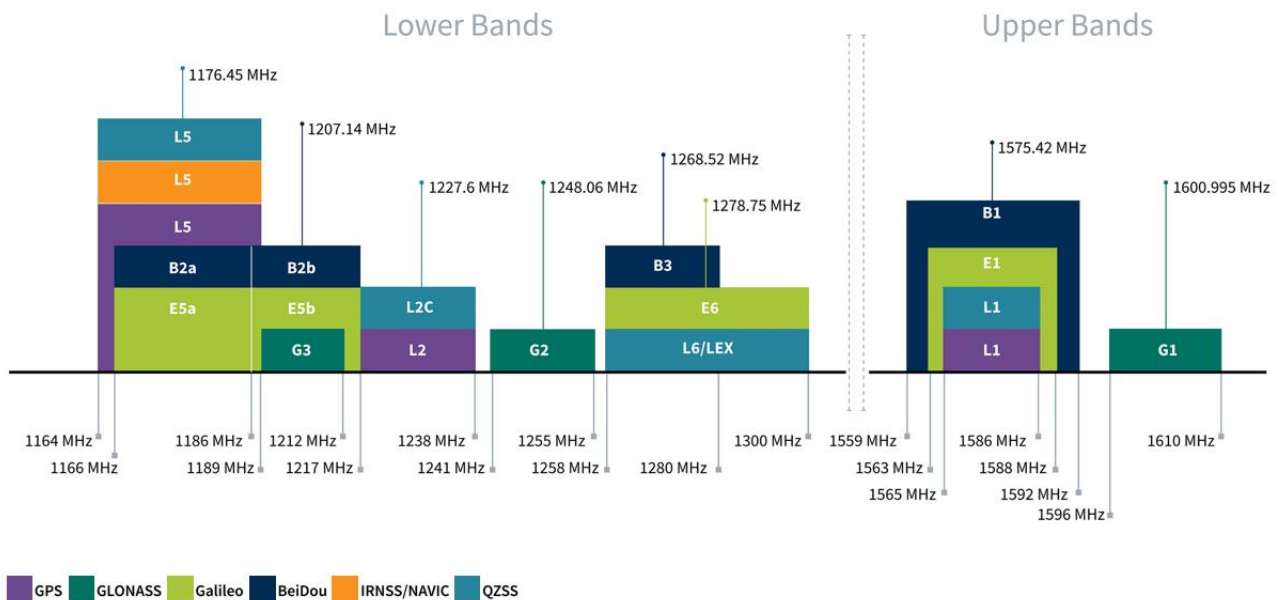

GNSS Bands and Constellations

Electrical				
Frequency (MHz)	GPS L5 / GLONASS E5a / IRNSS L5 / BeiDou B2a	BeiDou B1	GPS L1 / Galileo E1	GLONASS G1
	1166-1186	1559-1563	1563-1587	1593-1610
Efficiency (%)	58.5	68.5	60.7	62.5
Peak Gain(dBi)	2.31	2.94	2.87	3.08
Average Gain(dB)	-2.33	-1.64	-2.17	-2.04
Polarization	R.H.C.P.			
Radiation Pattern	Omni			
Impedance	50 Ω			

Mechanical	
Planner Dimension	25*25*8mm
Ground Plane	70*70mm
Connection Type	Pin & Adhesive Mount

Environmental	
Temperature Range	-40°C to 85°C
Humidity	Non-condensing 65°C 95% RH

3. Antenna Characteristics

3.1 Return Loss

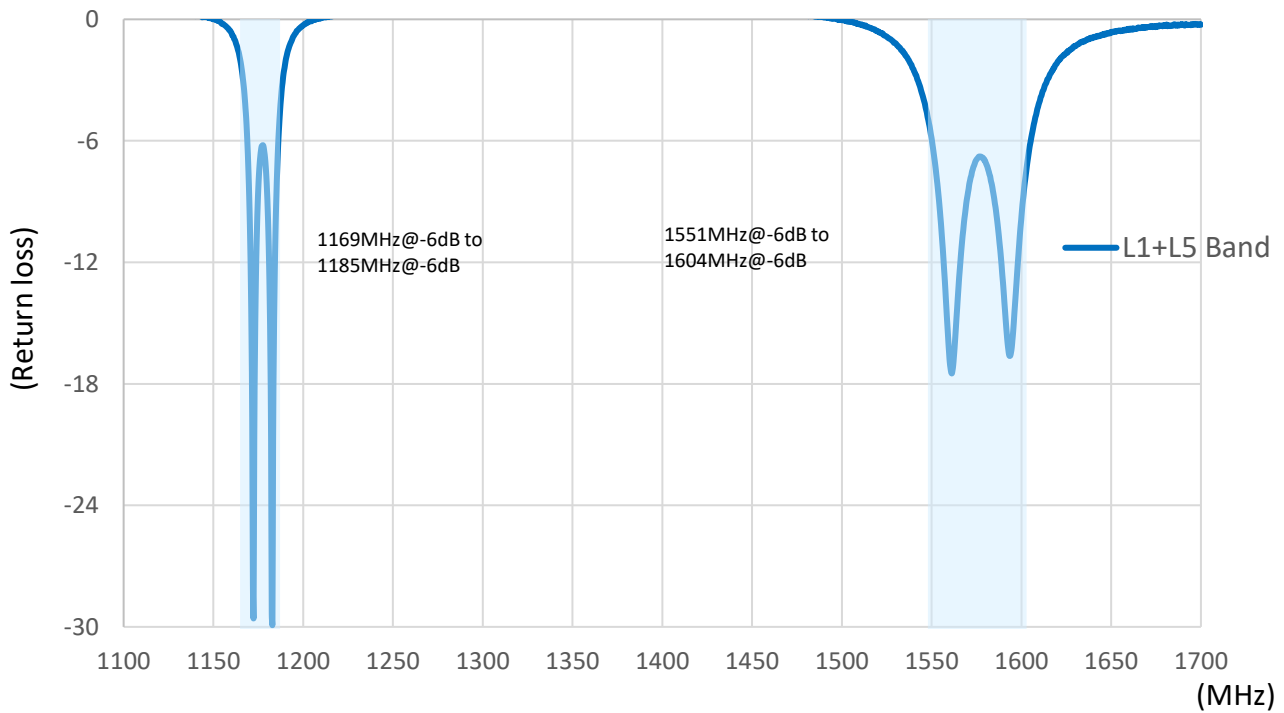

3.2 Efficiency

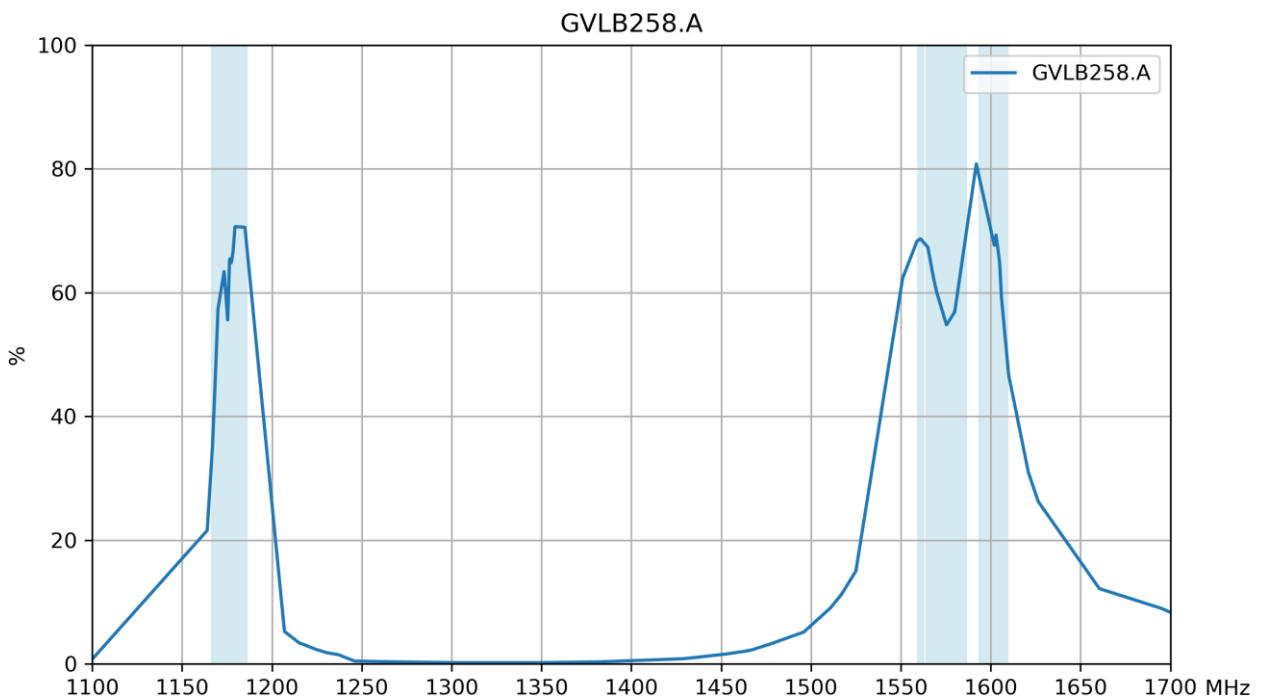

3.3 Average Gain

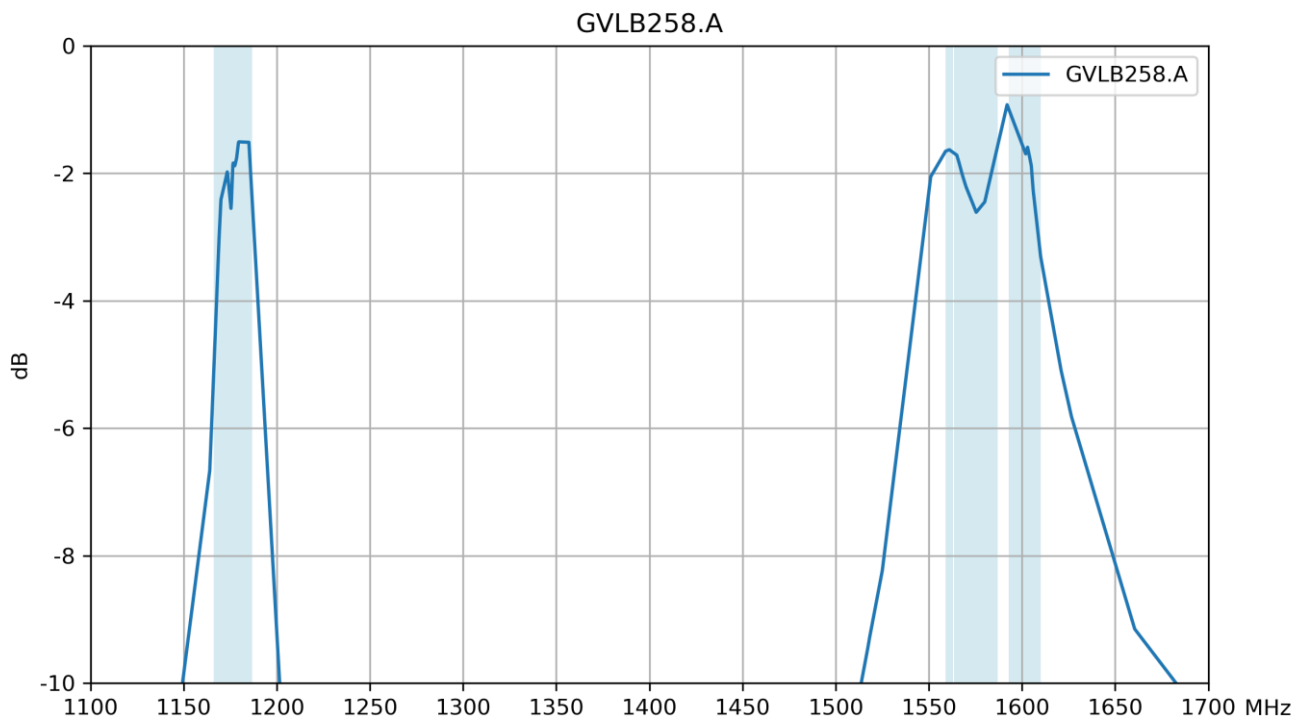

3.4 Peak Gain

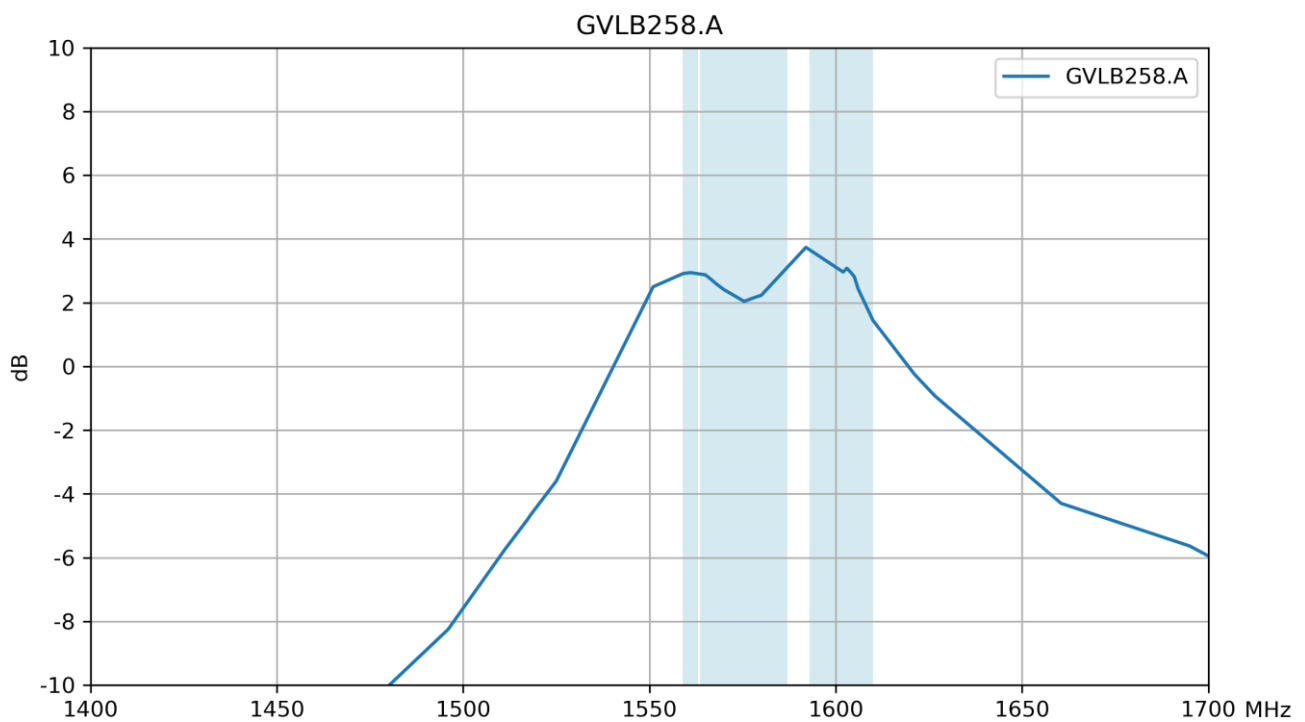

3.5 Axial Ratio – X-Z

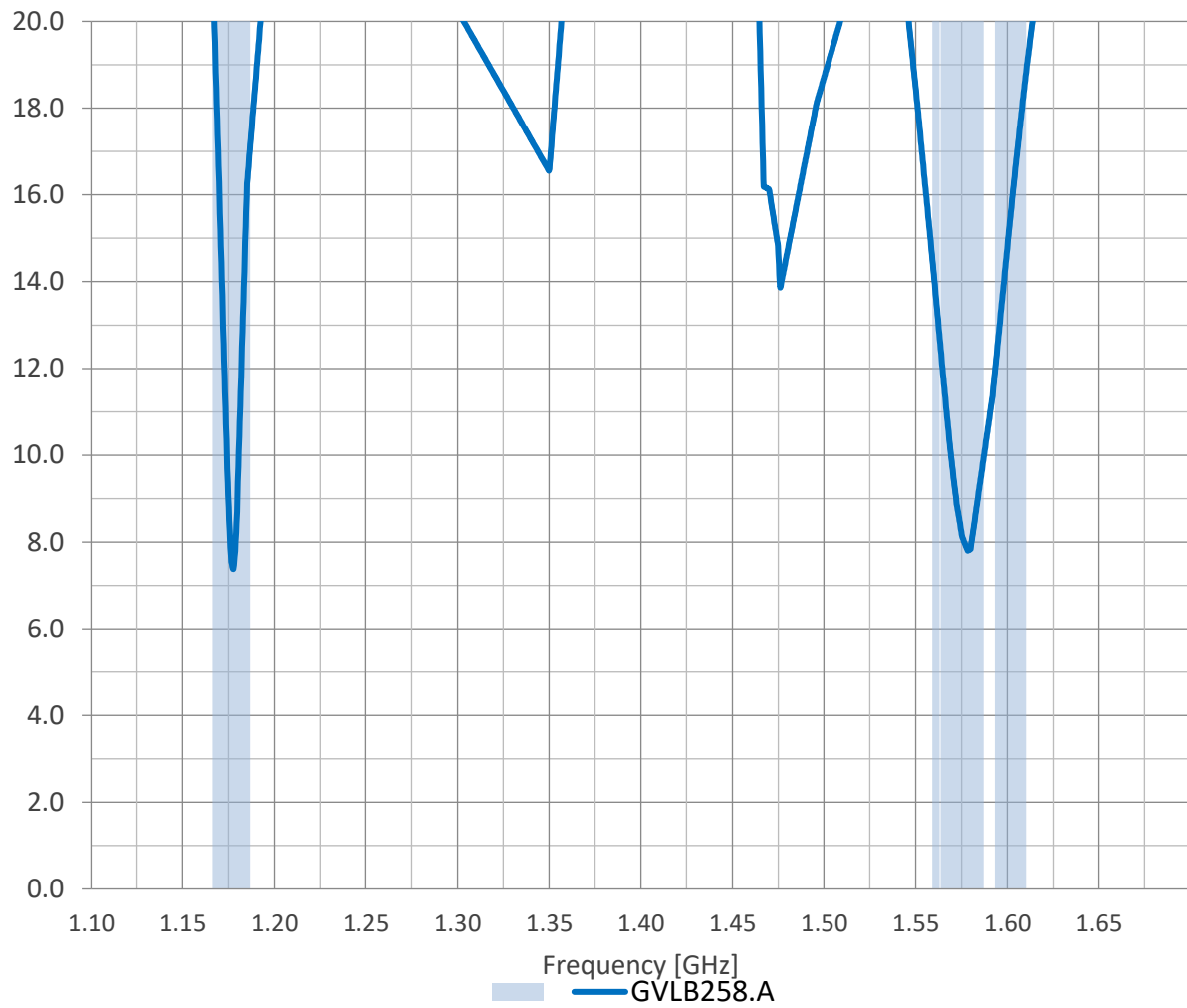

4. Radiation Patterns

4.1 Test Setup

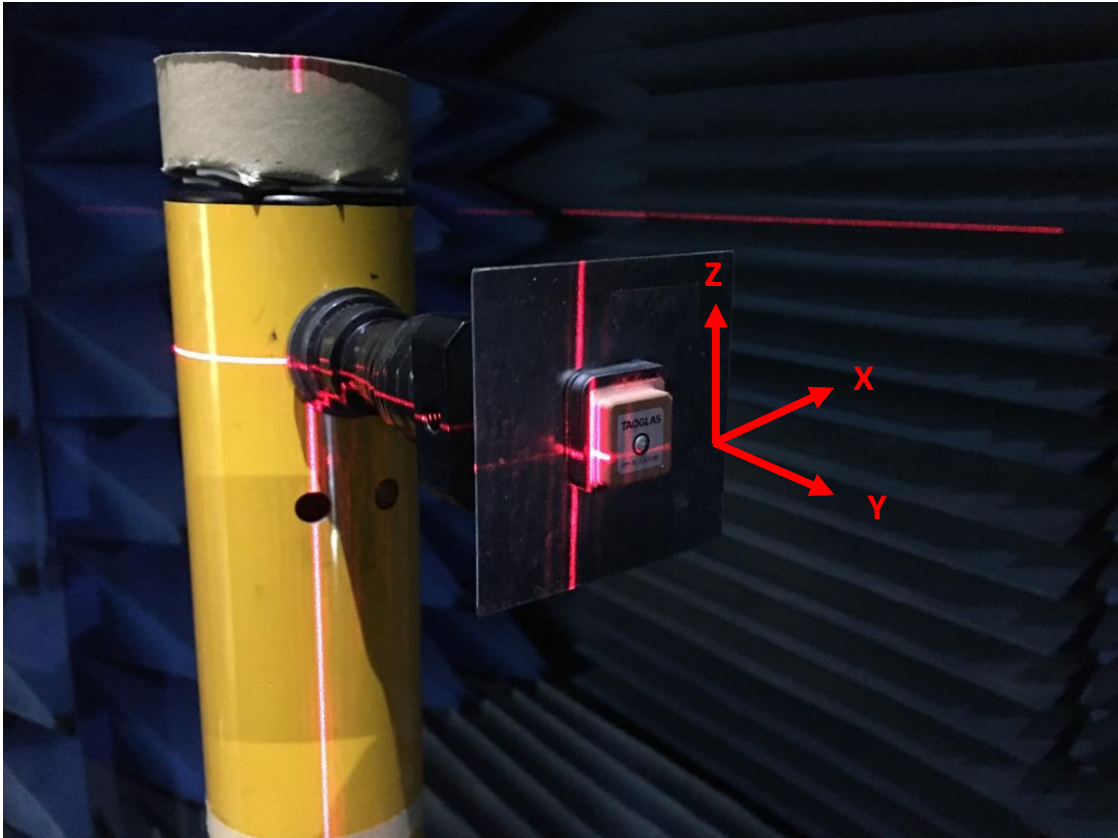

Tested on 70*70mm Ground Plane Evaluation Board

4.2 2D Radiation Patterns

1176MHz

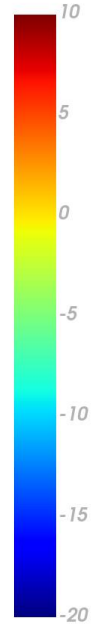
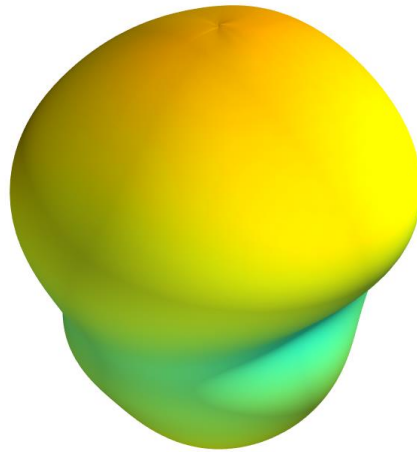

XY Plane

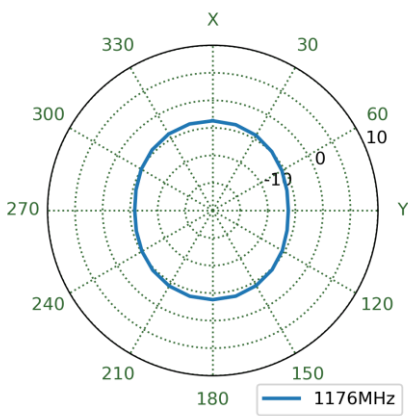

XZ Plane

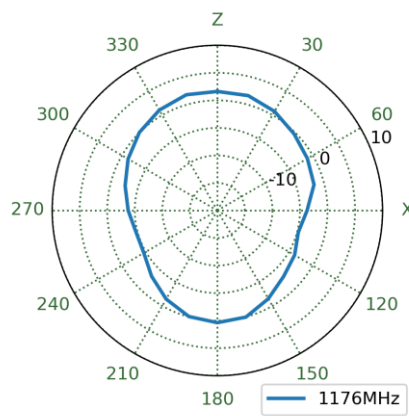

YZ Plane

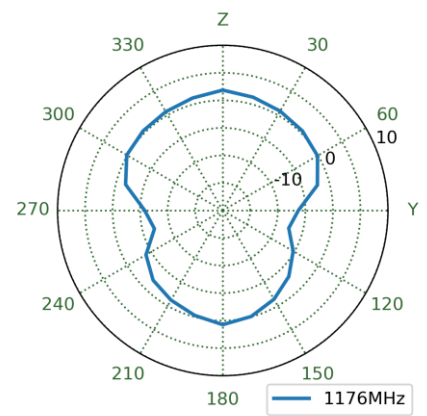

1561MHz

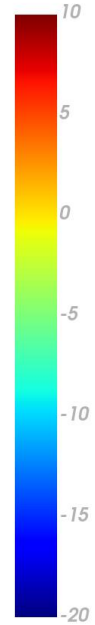
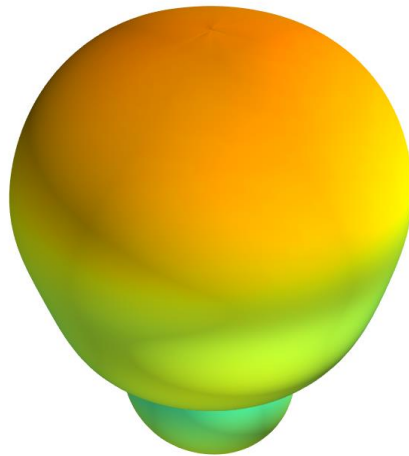

XY Plane

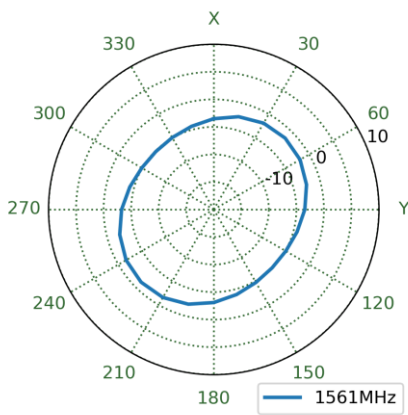

XZ Plane

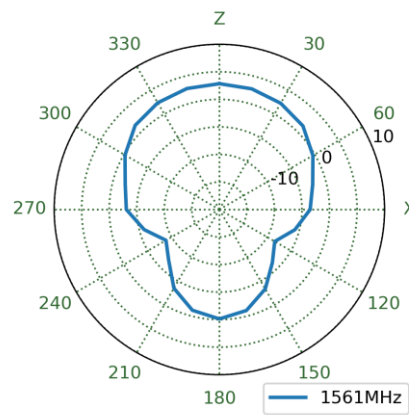

YZ Plane

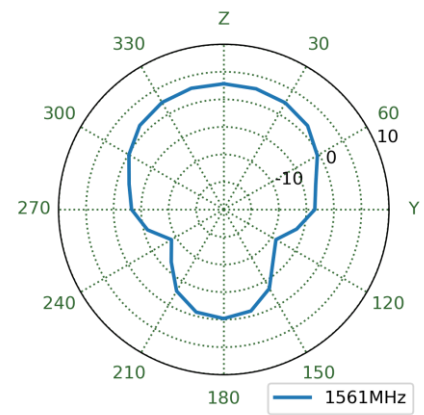

1575MHz

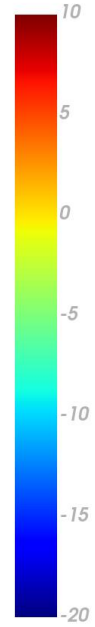
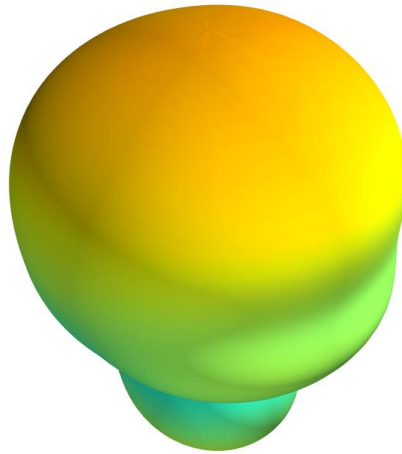

XY Plane

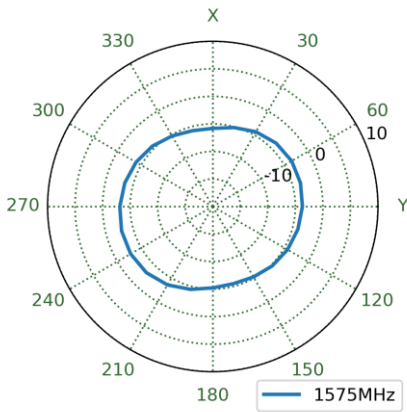

XZ Plane

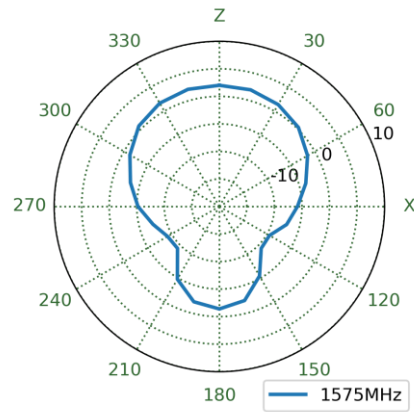

YZ Plane

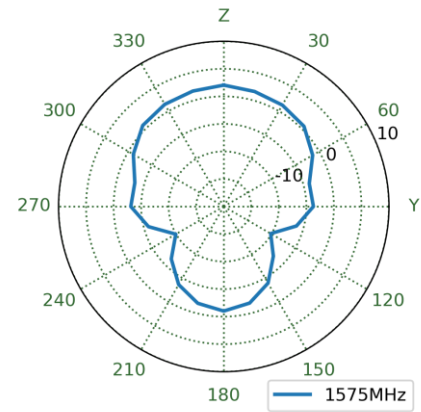

1602MHz

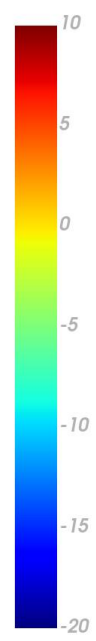
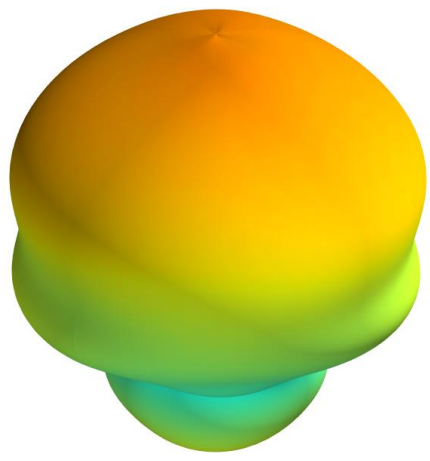

XY Plane

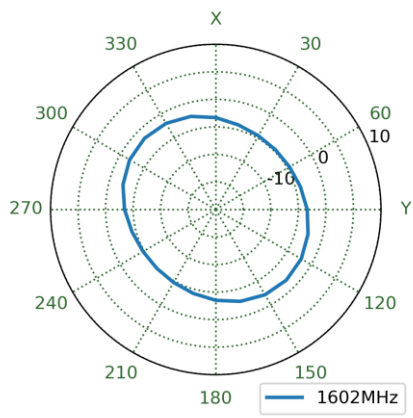

XZ Plane

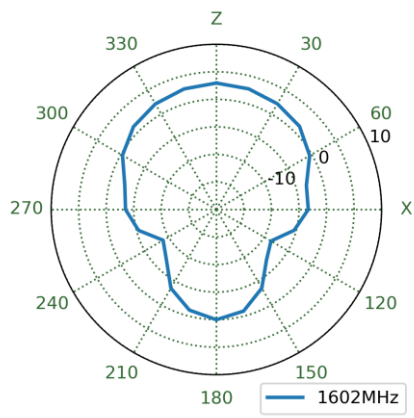

YZ Plane

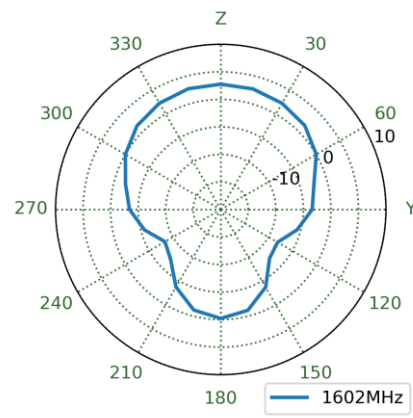

5. Mechanical Drawing (Units: mm)

ISO NO.: EDW-21-8-0598

STATE: Release

NOTES: 1. Double Sided Adhesive Area 2. Soldermask Area

REV.	DESCRIPTION	ENG.	APPROVED	DATE
D01	Initial Design	Aron Yan	Wing	2021/05/06

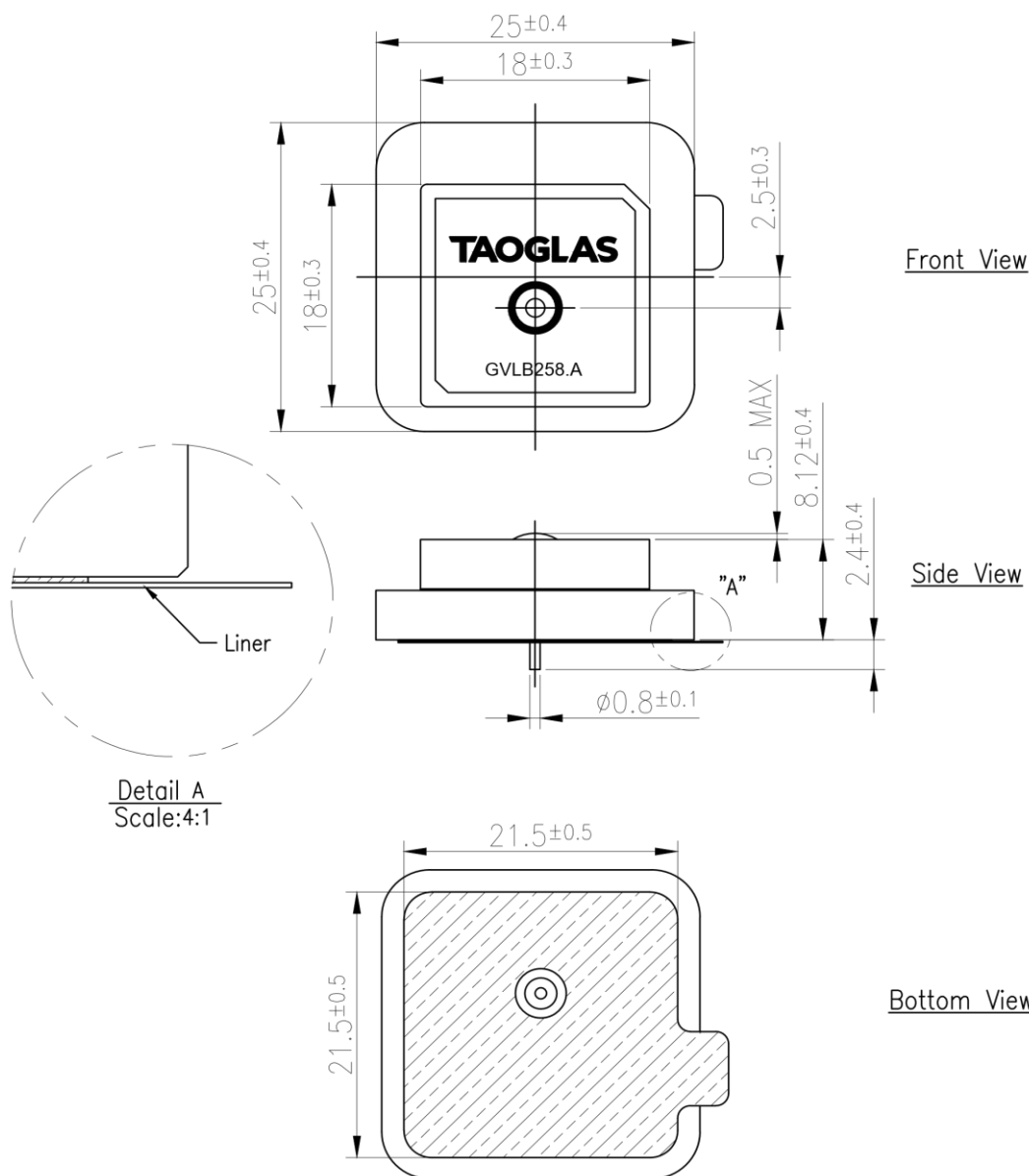

Detail A
Scale:4:1

	Name	Material	Finish	QTY
1	Patch(18*18*)	Ceramic	Clear	1
2	Patch(25*25*)	Ceramic	Clear	1

APPROVED BY: Wing	TW Design Centre This drawing and its inherent design concepts are property of Taoglas. Not to be copied or given to third parties without the written consent of Taoglas.
CHECK BY: Adam	
DRAWN BY: Aron Yan	
DATE: 2021/05/06	TITLE : GPS/GLONASS/BeiDou Single Feed Stacked Patch L1:1575MHz L5:1176.45MHz B1:1561MHz 25*25*8mm
UNLESS OTHERWISE SPECIFIED TOLERANCES ON: XX±0.5 X±0.3 X±0.2 XXX±0.1 XXXX±0.05	PART NO. : GVLB258.A
THIRD ANGLE PROJECTION	UNIT: mm SCALE: 2:1 PAGES: 1/1 REV. D01

6. Footprint

Top View

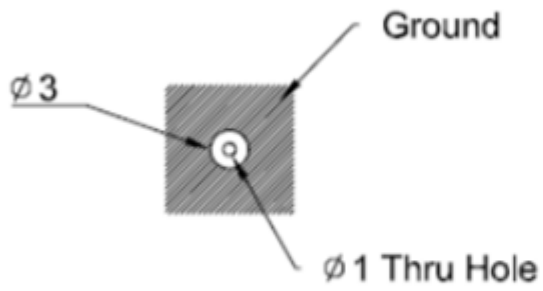

Bottom View

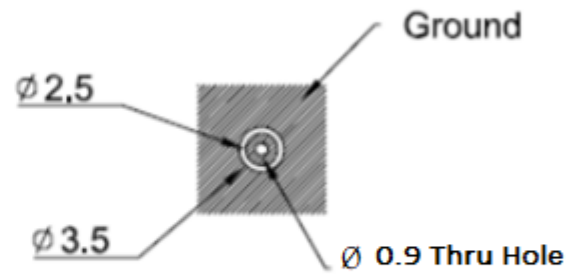

Tolerance: +/- 0,20
Unit:mm

7. Packaging

24pcs GVLB258.A per Tray
 Tray Dimensions: 255*144*8mm
 Weight: 0.460Kg

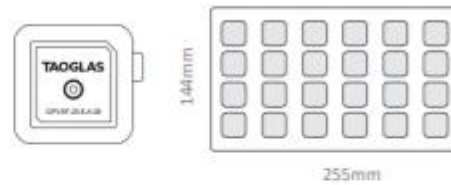

96pcs GVLB258.A per Inner Carton
 Dimensions: 263*154*96mm
 Weight: 2Kg

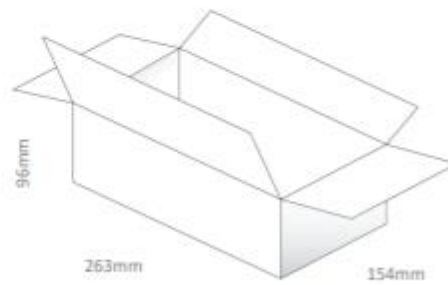

384pcs GVLB258.A per Large Carton
 Dimensions: 327*280*218mm
 Weight: 9Kg

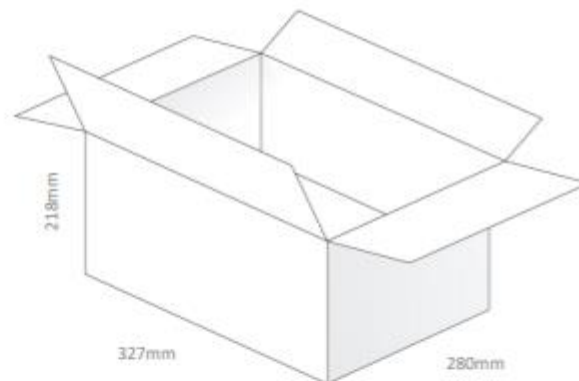

Pallet Dimensions:
 1200*1000*1280mm
 36 Cartons Per Pallet
 9 Cartons Per Layer, 4 Layers

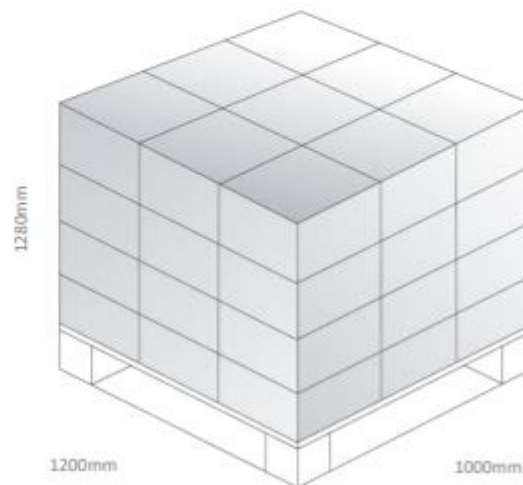

Changelog for the datasheet

SPE-21-8-082 – GVLB258.A

Revision: A (Original First Release)

Date:	2021-09-06
Notes:	Initial Release
Author:	Jack Conroy

Previous Revisions



TAOGLAS®

www.taoglas.com

