

## 2A, 50V - 1400V Standard Bridge Rectifier

### FEATURES

- AEC-Q101 qualified available
- Ideal for printed circuit board
- Reliable low cost construction utilizing molded plastic technique
- High surge current capability
- UL Recognized File # E-326854
- Moisture sensitivity level: level 1, per J-STD-020
- RoHS Compliant
- Halogen-free according to IEC 61249-2-21

### APPLICATIONS

- Switching mode power supply (SMPS)
- Adapters
- Lighting application

### MECHANICAL DATA

- Case: DBLS
- Molding compound meets UL 94V-0 flammability rating
- Terminal: Matte tin plated leads, solderable per J-STD-002
- Meet JESD 201 class 2 whisker test
- Polarity: As marked
- Weight: 0.360g (approximately)

KEY PARAMETERS		
PARAMETER	VALUE	UNIT
$I_F$	2	A
$V_{RRM}$	50 - 1400	V
$I_{FSM}$	50	A
$T_{J\ MAX}$	150	°C
Package	DBLS	
Configuration	Quad	

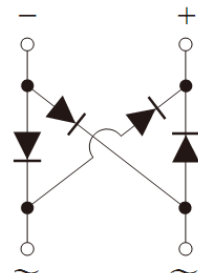
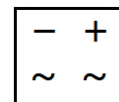
**DBLS**

ABSOLUTE MAXIMUM RATINGS ( $T_A = 25^\circ\text{C}$ unless otherwise noted)											
PARAMETER	SYMBOL	DBLS 201G	DBLS 202G	DBLS 203G	DBLS 204G	DBLS 205G	DBLS 206G	DBLS 207G	DBLS 208G	DBLS 209G	UNIT
Marking code on the device		DBLS 201G	DBLS 202G	DBLS 203G	DBLS 204G	DBLS 205G	DBLS 206G	DBLS 207G	DBLS 208G	DBLS 209G	
Repetitive peak reverse voltage	$V_{RRM}$	50	100	200	400	600	800	1000	1200	1400	V
Reverse voltage, total rms value	$V_{R(RMS)}$	35	70	140	280	420	560	700	840	980	V
Forward current	$I_F$	2									A
Peak forward surge current, 8.3ms single half sine-wave superimposed on rated load	$I_{FSM}$	50									A
Rating for fusing ( $t < 8.3\text{ms}$ )	$I^2t$	10.3									$\text{A}^2\text{s}$
Junction temperature	$T_J$	- 55 to +150									°C
Storage temperature	$T_{STG}$	- 55 to +150									°C

<b>THERMAL PERFORMANCE</b>			
<b>PARAMETER</b>	<b>SYMBOL</b>	<b>TYP</b>	<b>UNIT</b>
Junction-to-lead thermal resistance	$R_{\theta JL}$	15	°C/W
Junction-to-ambient thermal resistance	$R_{\theta JA}$	40	°C/W

<b>ELECTRICAL SPECIFICATIONS</b> ( $T_A = 25^\circ\text{C}$ unless otherwise noted)						
<b>PARAMETER</b>		<b>CONDITIONS</b>	<b>SYMBOL</b>	<b>TYP</b>	<b>MAX</b>	<b>UNIT</b>
Forward voltage per diode <sup>(1)</sup>	DBLS201G	$I_F = 2\text{A}, T_J = 25^\circ\text{C}$	$V_F$	-	1.15	V
	DBLS202G					
	DBLS203G					
	DBLS204G					
	DBLS205G					
	DBLS206G					
	DBLS207G					
	DBLS208G			-	1.30	V
	DBLS209G			-	1.30	V
Reverse current @ rated $V_R$ per diode <sup>(2)</sup>		$T_J = 25^\circ\text{C}$	$I_R$	-	2	$\mu\text{A}$
		$T_J = 125^\circ\text{C}$		-	500	$\mu\text{A}$

**Notes:**

1. Pulse test with  $PW = 0.3\text{ms}$
2. Pulse test with  $PW = 30\text{ms}$

<b>ORDERING INFORMATION</b>		
<b>ORDERING CODE</b> <sup>(1)(2)</sup>	<b>PACKAGE</b>	<b>PACKING</b>
DBLS2xG	DBLS	1,500 / Tape & Reel
DBLS2xGH	DBLS	1,500 / Tape & Reel

**Notes:**

1. "x" defines voltage from 50V(DBLS201G) to 1400V(DBLS209G)
2. "H" means AEC-Q101 qualified

**CHARACTERISTICS CURVES**

( $T_A = 25^\circ\text{C}$  unless otherwise noted)

**Fig.1 Forward Current Derating Curve**

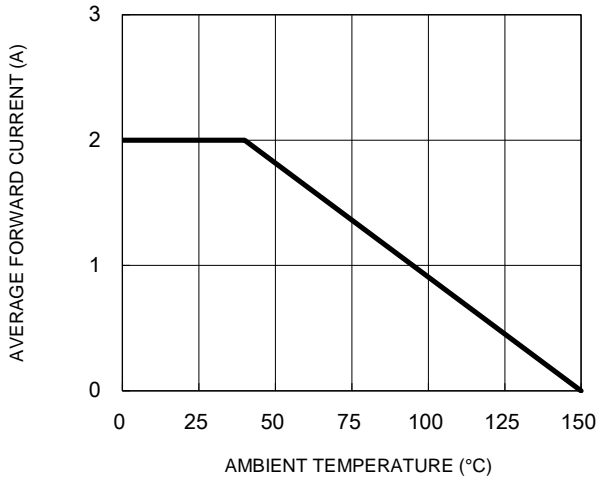

**Fig.2 Typical Junction Capacitance**

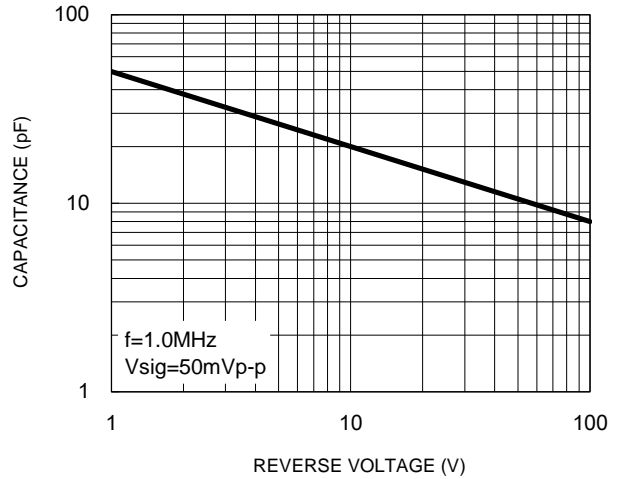

**Fig.3 Typical Reverse Characteristics**

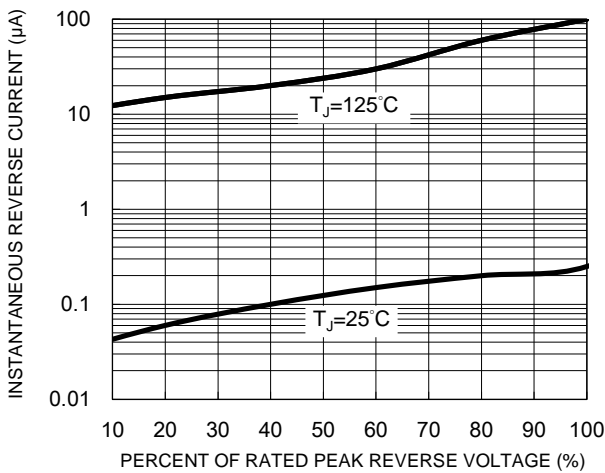

**Fig.4 Typical Forward Characteristics**

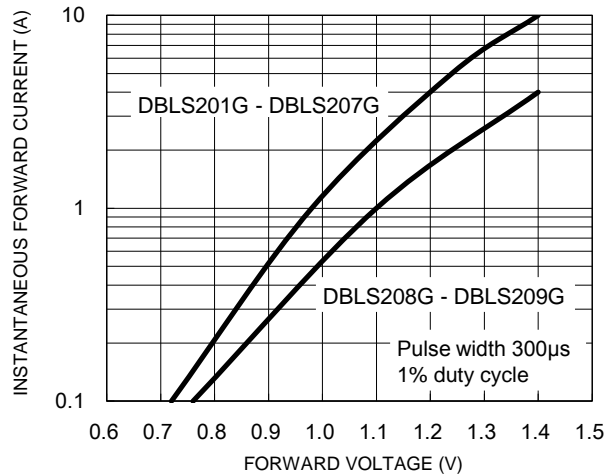

**Fig.5 Maximum Non-Repetitive Forward Surge Current**

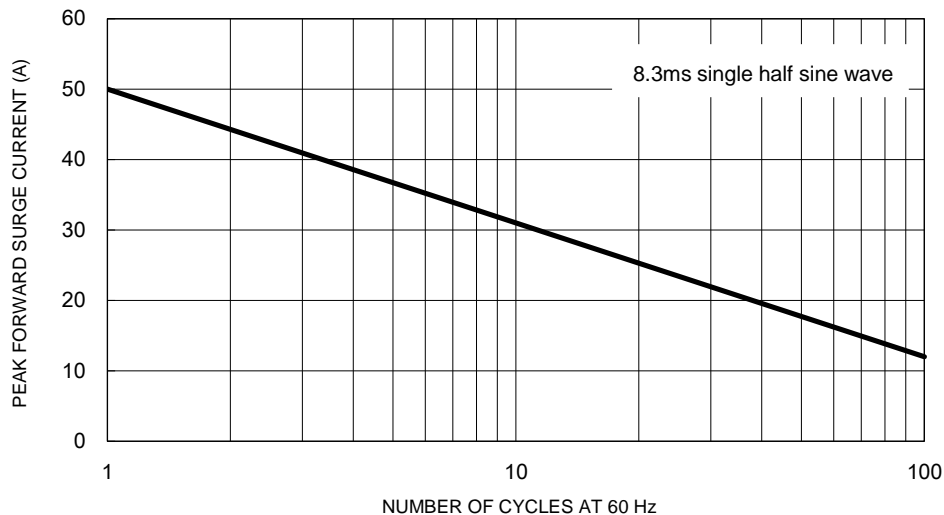

**PACKAGE OUTLINE DIMENSIONS**

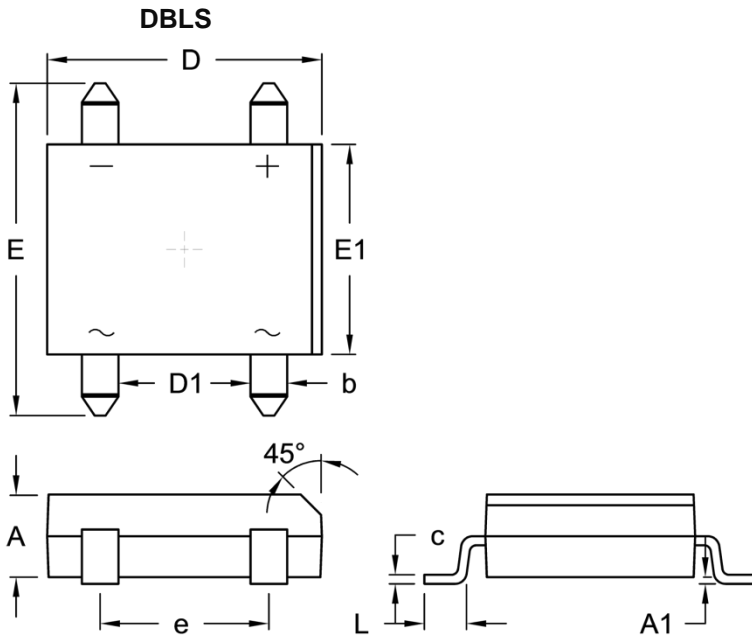

DIM.	Unit (mm)		Unit (inch)	
	Min.	Max.	Min.	Max.
A	2.40	2.60	0.094	0.102
A1	0.076	0.330	0.003	0.013
b	1.02	1.20	0.040	0.047
c	0.22	0.33	0.009	0.013
D	8.13	8.51	0.320	0.335
D1	3.90	4.10	0.154	0.161
E	9.80	10.30	0.386	0.406
E1	6.20	6.50	0.244	0.256
e	5.00	5.20	0.197	0.205
L	1.02	1.53	0.040	0.060

**SUGGESTED PAD LAYOUT**

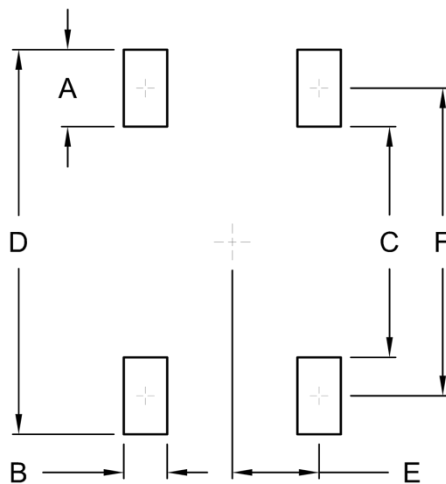

Symbol	Unit (mm)	Unit (inch)
A	2.30	0.091
B	1.30	0.051
C	6.90	0.272
D	11.50	0.453
E	2.60	0.102
F	9.20	0.362

**MARKING DIAGRAM**



- P/N = Marking Code
- G = Green Compound
- YW = Date Code
- F = Factory Code

## **Notice**

Specifications of the products displayed herein are subject to change without notice. TSC or anyone on its behalf, assumes no responsibility or liability for any errors or inaccuracies.

Purchasers are solely responsible for the choice, selection, and use of TSC products and TSC assumes no liability for application assistance or the design of Purchasers' products.

Information contained herein is intended to provide a product description only. No license, express or implied, to any intellectual property rights is granted by this document. Except as provided in TSC's terms and conditions of sale for such products, TSC assumes no liability whatsoever, and disclaims any express or implied warranty, relating to sale and/or use of TSC products including liability or warranties relating to fitness for a particular purpose, merchantability, or infringement of any patent, copyright, or other intellectual property right.

The products shown herein are not designed for use in medical, life-saving, or life-sustaining applications. Customers using or selling these products for use in such applications do so at their own risk and agree to fully indemnify TSC for any damages resulting from such improper use or sale.