

ANT-W63-MSA-TH1 Stamped Metal WiFi 6/6E Antenna

The ANT-W63-MSA-TH1 is a stamped metal antenna designed for superior performance in WiFi 6/WiFi 6E applications in the 2.4 GHz, 5 GHz and 6 GHz bands.

The ANT-W63-MSA-TH1 antenna exhibits excellent performance in a compact size (15 mm x 17 mm x 10 mm). It is packaged in trays and is designed for through-hole mounting directly to a printed circuit board.

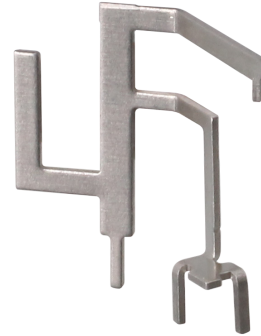

Features

- Performance at 5.150 GHz to 5.895 GHz
 - VSWR: ≤ 1.9
 - Peak Gain: 3.8 dBi
 - Efficiency: 61%
- Performance at 5.950 GHz to 7.125 GHz
 - VSWR: ≤ 3.2
 - Peak Gain: 3.8 dBi
 - Efficiency: 55%
- Compact, low-profile
 - 15.0 mm x 17.2 mm x 9.8 mm
- Omnidirectional radiation pattern
- Reflow- or hand-solder assembly

Applications

- WiFi/WLAN coverage
 - WiFi 6E (802.11ax)
 - WiFi 6 (802.11ax)
 - WiFi 5 (802.11ac)
 - WiFi 4 (802.11n)
 - 802.11b/g
- 2.4 GHz ISM applications
 - Bluetooth®, ZigBee®
- U-NII bands 1-8
- Internet of Things (IoT) devices
- Smart Home networking
- Sensing and remote monitoring

Ordering Information

Part Number	Description
ANT-W63-MSA-TH1	Through-hole PCB-mount stamped metal WiFi 6/6E antenna
AEK-W63-MSA-TH1	Antenna evaluation kit

Available from Linx Technologies and select distributors and representatives.

Table 1. Electrical Specifications

Parameter	ISM/WiFi	WiFi/U-NII 1-3	WiFi 6E
Frequency Range	2400 MHz to 2500 MHz	5150 MHz to 5895 MHz	5950 MHz to 7125 MHz
VSWR (max.)	2.9	1.9	3.2
Peak Gain (dBi)	3.5	3.8	3.8
Average Gain (dBi)	-2.8	-2.5	-3.2
Efficiency (%)	54	61	55
Impedance	50 Ω	Max Power	1 W
Wavelength	1/4-wave	Electrical Type	Monopole
Polarization	Linear	Radiation	Omnidirectional

Electrical specifications and plots measured with a 40.0 mm x 50.0 mm (1.57 in x 1.97 in) reference ground plane.

Table 2. Mechanical Specifications

Parameter	Value
Connection	Through-hole solder
Dimensions	15.0 mm x 17.2 mm x 9.8 mm (0.59 in x 0.68 in x 0.38 in)
Weight	0.4 g (0.02 oz)
Operating Temp. Range	-40 °C to +85 °C

Product Dimensions

Figure 1 provides dimensions for the ANT-W63-MSA-TH1 antenna

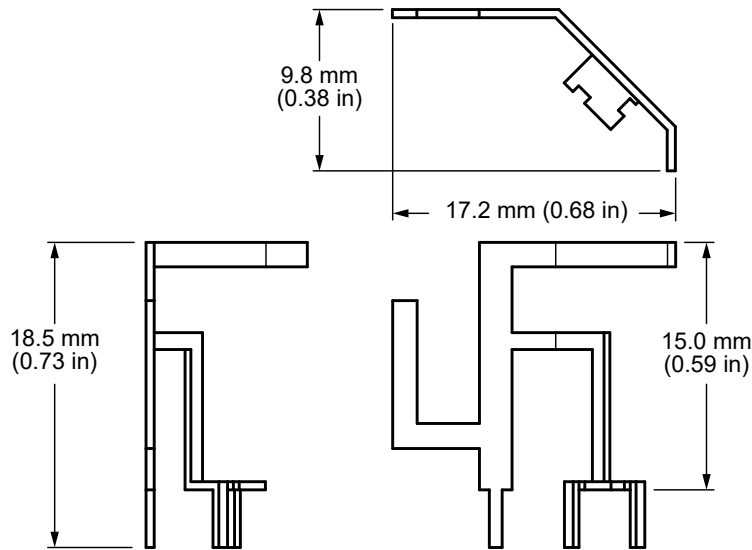

Figure 1. ANT-W63-MSA-TH1 Antenna Dimensions

Antenna Packaging

The ANT-W63-MSA-TH1 antenna is sealed in plastic trays in quantities of 135 pcs. Trays are packaged in cartons of 2835 pcs. Distribution channels may offer alternative packaging options.

Antenna Orientation

The ANT-W63-MSA-TH1 antenna is characterized on a ground plane as shown in Figure 2. Characterization with an adjacent ground plane (40 mm x 50 mm) provides insight into antenna performance when attached directly to a printed circuit board mounted connector. This orientation represents the most common end-product use case.

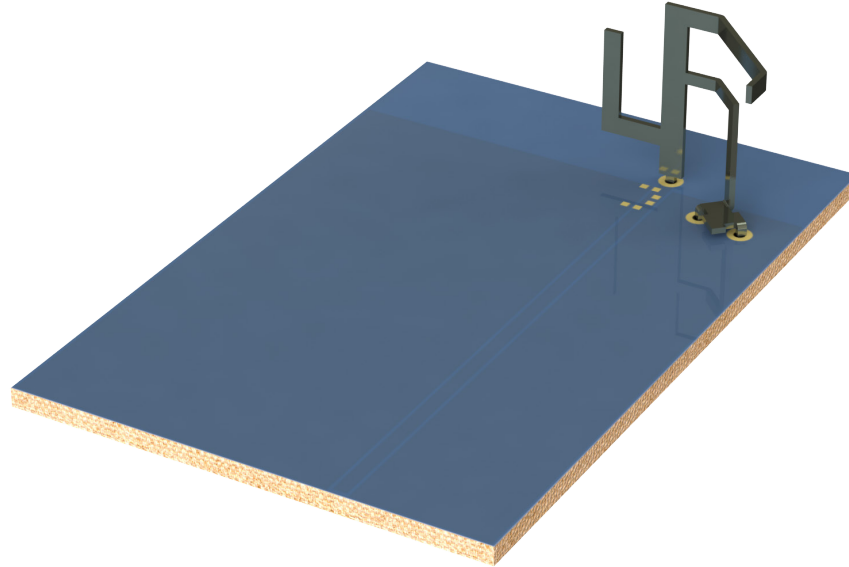

Figure 2. ANT-W63-MSA-TH1 Test Orientation

VSWR

Figure 3 provides the voltage standing wave ratio (VSWR) across the antenna bandwidth. VSWR describes the power reflected from the antenna back to the radio. A lower VSWR value indicates better antenna performance at a given frequency. Reflected power is also shown on the right-side vertical axis as a gauge of the percentage of transmitter power reflected back from the antenna.

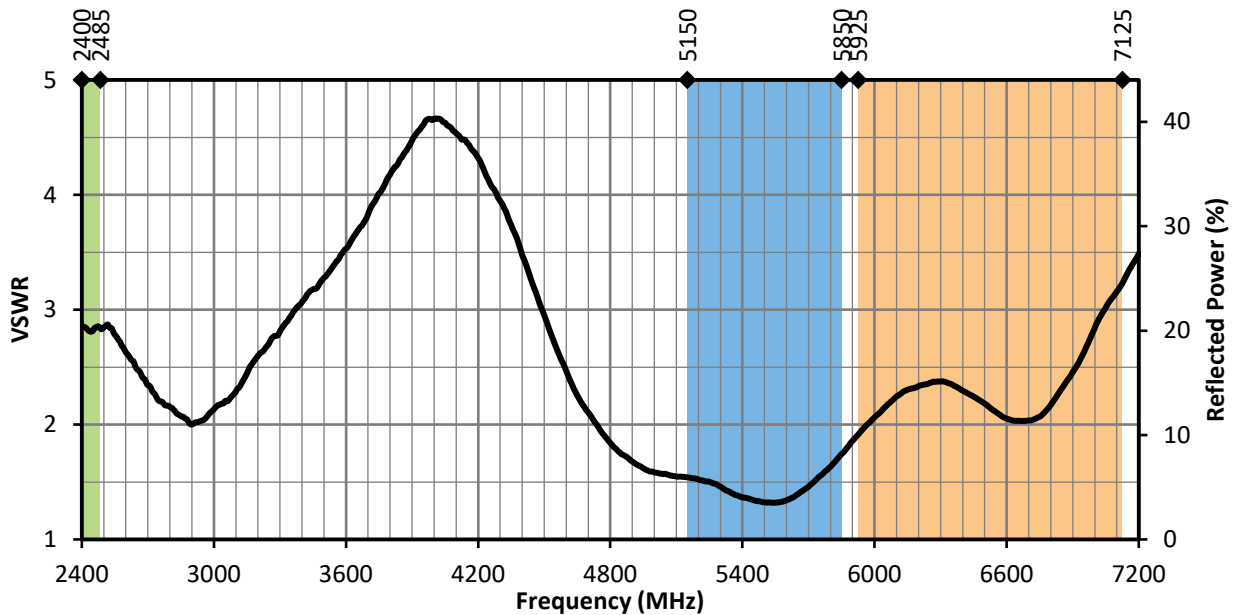

Figure 3. ANT-W63-MSA-TH1 Antenna VSWR with Frequency Band Highlights

Return Loss

Return loss (Figure 4), represents the loss in power at the antenna due to reflected signals. Like VSWR, a lower return loss value indicates better antenna performance at a given frequency.

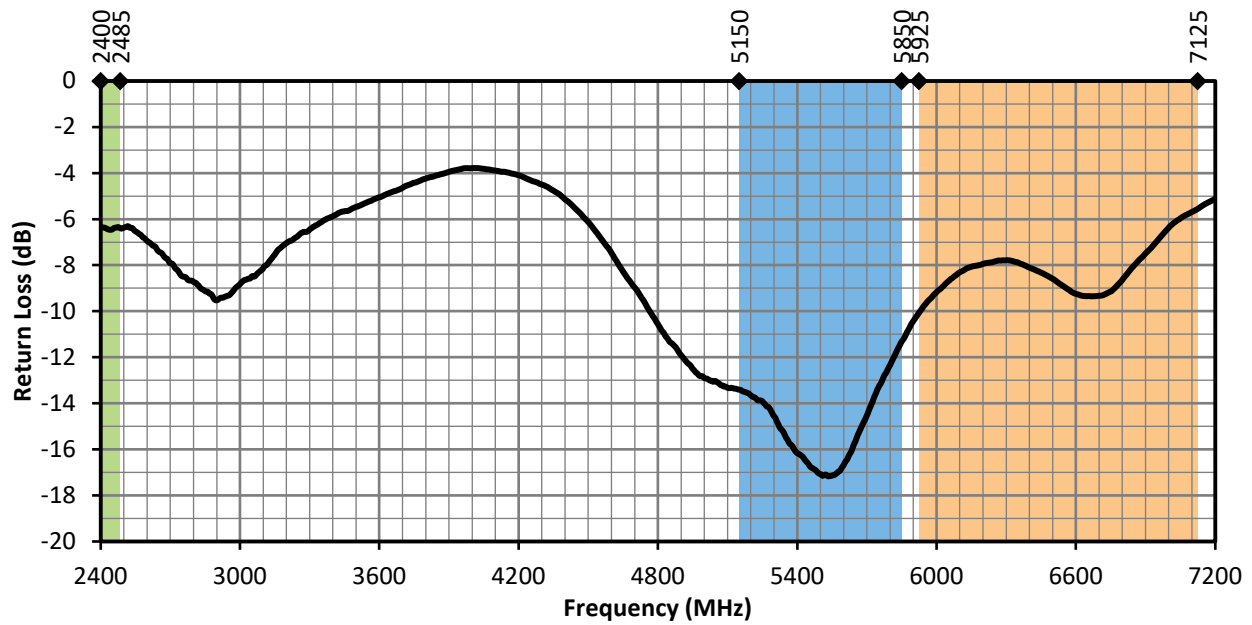

Figure 4. ANT-W63-MSA-TH1 Return Loss with Frequency Band Highlights

Peak Gain

The peak gain across the antenna bandwidth is shown in Figure 5. Peak gain represents the maximum antenna input power concentration across 3-dimensional space, and therefore peak performance at a given frequency, but does not consider any directionality in the gain pattern.

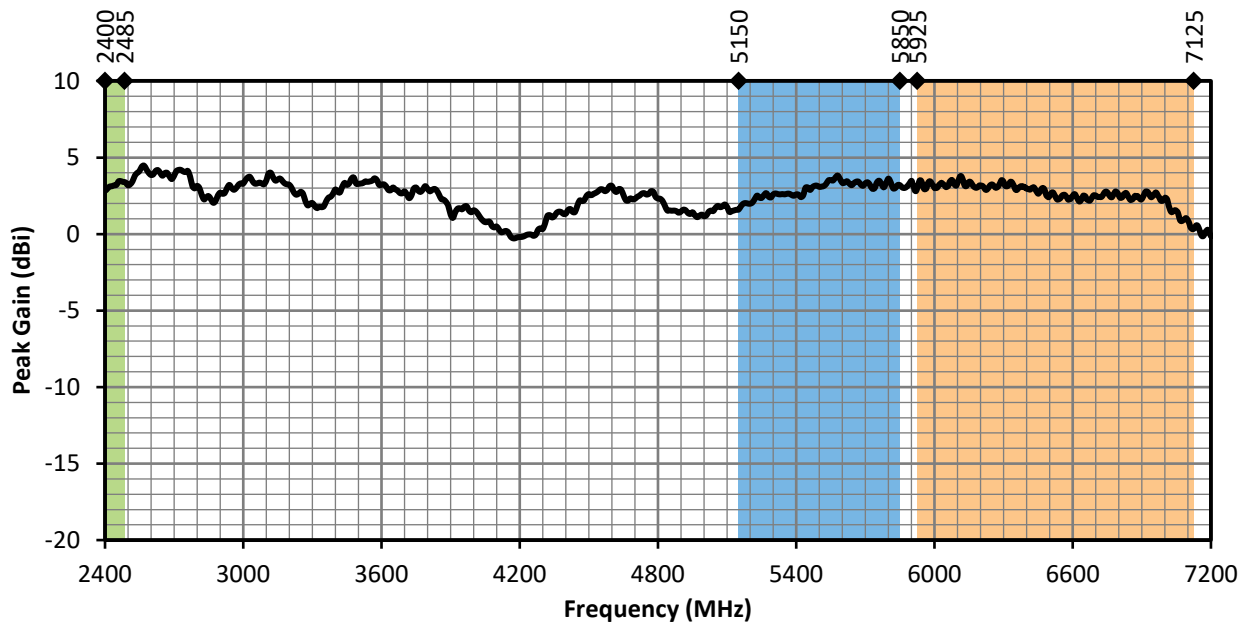

Figure 5. ANT-W63-MSA-TH1 Antenna Peak Gain with Frequency Band Highlights

Average Gain

Average gain (Figure 6), is the average of all antenna gain in 3-dimensional space at each frequency, providing an indication of overall performance without expressing antenna directionality.

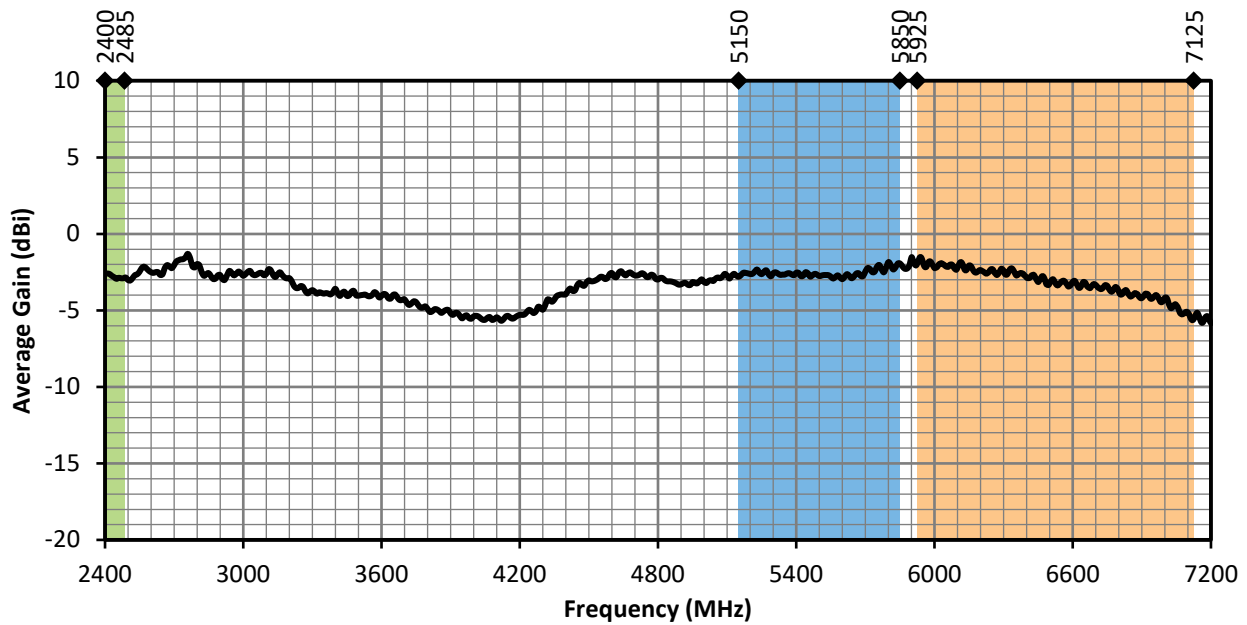

Figure 6. ANT-W63-MSA-TH1 Average Gain with Frequency Band Highlights

Radiation Efficiency

Radiation efficiency (Figure 7), shows the ratio of power delivered to the antenna relative to the power radiated at the antenna, expressed as a percentage, where a higher percentage indicates better performance at a given frequency.

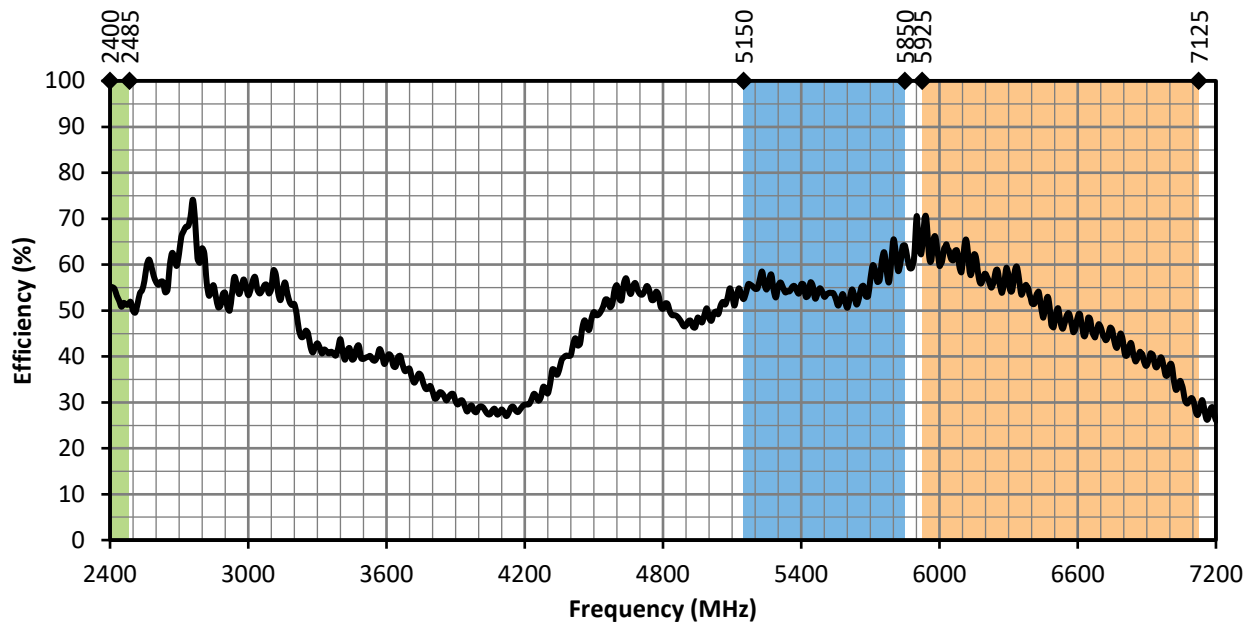
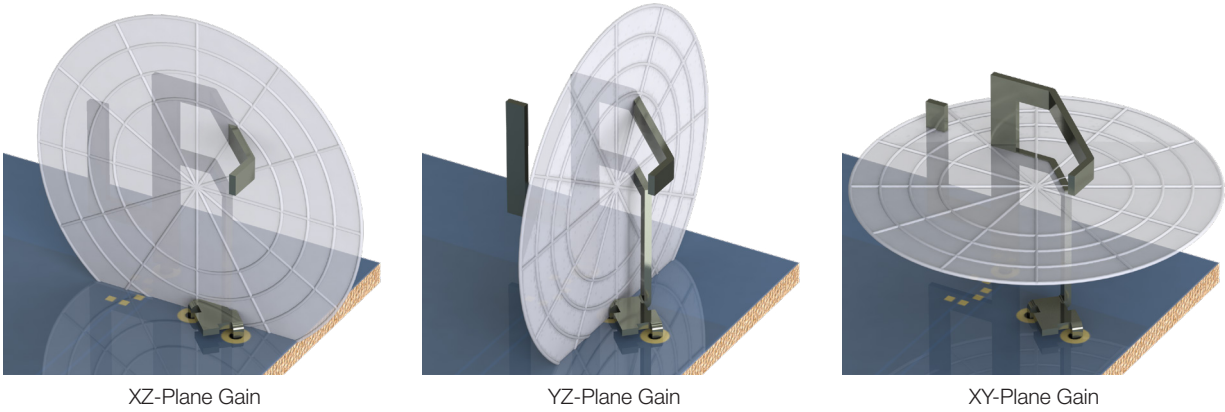

Figure 7. ANT-W63-MSA-TH1 Radiation Efficiency with Frequency Band Highlights

Radiation Patterns

Radiation patterns provide information about the directionality and 3-dimensional gain performance of the antenna by plotting gain at specific frequencies in three orthogonal planes. Antenna radiation patterns (Figure 8), are shown using polar plots covering 360 degrees. The antenna graphic above the plots provides reference to the plane of the column of plots below it. Note: when viewed with typical PDF viewing software, zooming into radiation patterns is possible to reveal fine detail.



2400 MHz to 2500 MHz (2450 MHz)

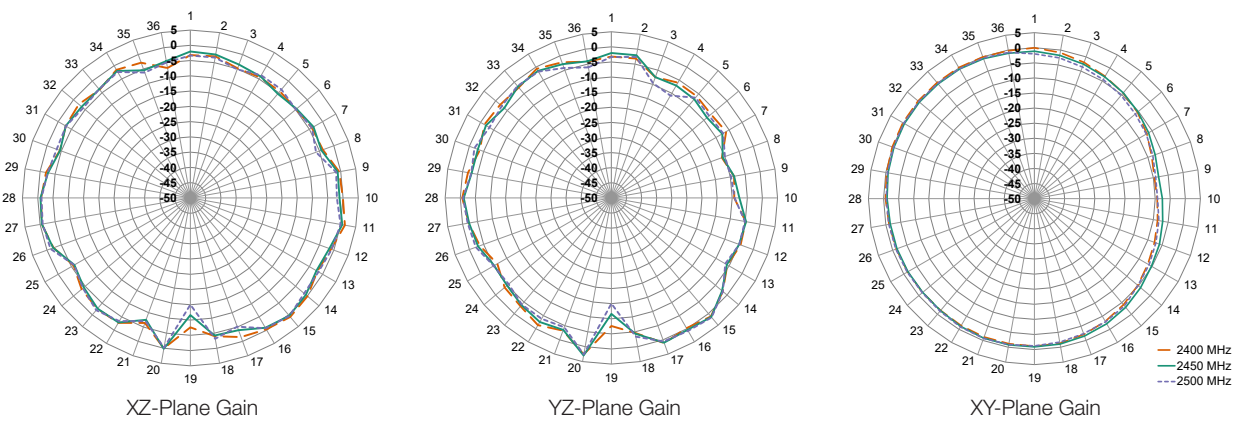

5150 MHz to 5895 MHz (5500 MHz)

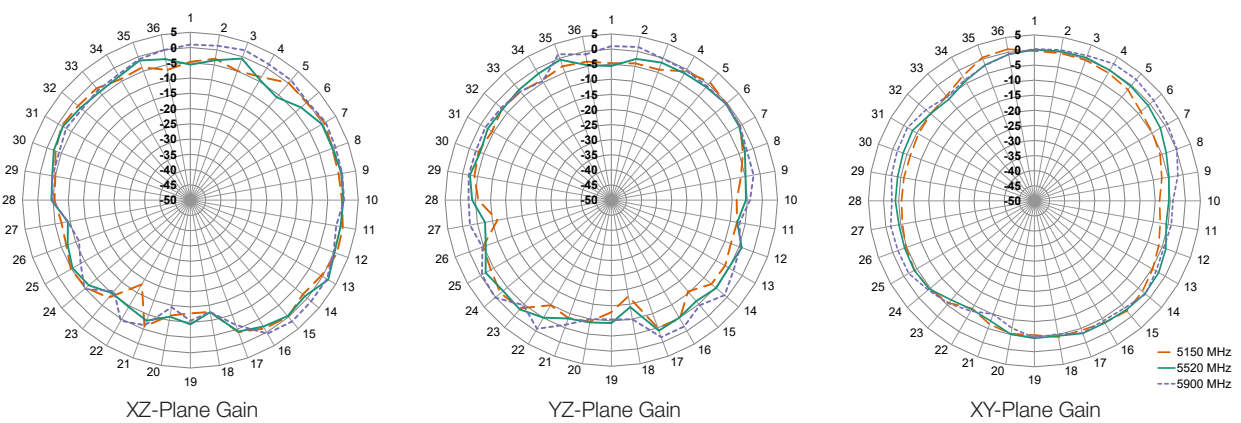

Radiation Patterns

5950 MHz to 7125 MHz (6500 MHz)

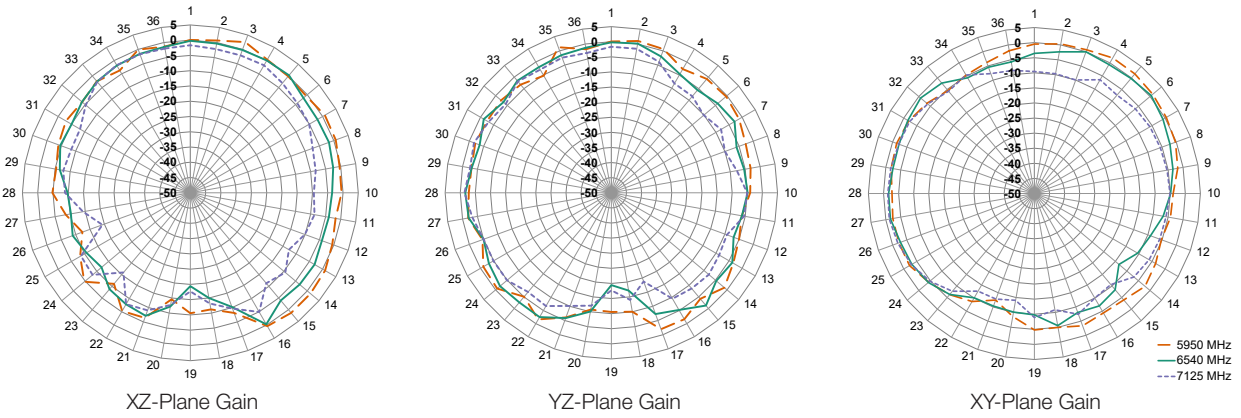

Figure 8. ANT-W63-MSA-TH1 Antenna Radiation Patterns

Design Implementation

The recommended design implementation of the ANT-W63-MSA-TH1 includes a matching network, ground plane and PCB transmission line from the antenna to the matching network and to the radio circuitry.

Ground Plane

The ANT-W63-MSA-TH1 is a 1/4-wave monopole antenna, and requires a ground plane on the PCB to which it is mounted. Linx recommends a 40 mm x 50 mm or larger ground plane. The ANT-W63-MSA-TH1 should be mounted in relation to the edge of the ground plane as shown in Figure 10. Other ground plane sizes and antenna mounting locations are possible. Linx offers PCB design reviews to help optimize solution performance.

Matching Network

Linx recommends inclusion of at least a 3-element, surface mount pi matching network of two parallel capacitors, (X1, X3) and one serial inductor, (X2) in all designs. (Figure 9) Surface mount components should be 0603 size. 0402 size components are also supported. The ANT-W63-MSA-TH1, as designed, does not require matching, but matching may improve end-product antenna performance depending on the effects of the enclosure, PCB and other electronic components. If no matching is necessary, the serial element may be populated with a zero-ohm resistor and no components in the two capacitor positions.

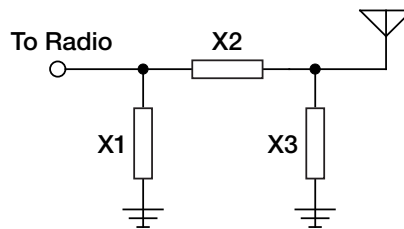

Figure 9. Matching Network Recommendation

Recommended PCB Layout

Figure 10 shows the recommended printed circuit board layout for the ANT-W63-MSA-TH1 antenna.

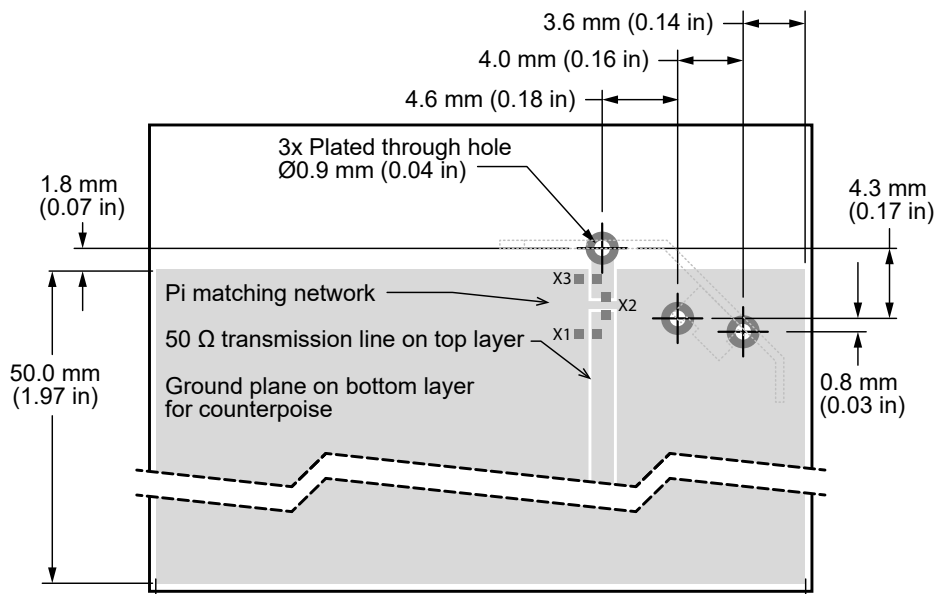

Figure 10. ANT-W63-MSA-TH1 Recommended Layout

Transmission Lines for Embedded Antennas

For most designs, Linx recommends a microstrip transmission line for the ANT-W63-MSA-TH1. A microstrip transmission line is a PCB trace that runs over a ground plane to maintain the characteristic impedance for optimal signal transfer between the antenna and radio circuitry. Linx designs all antennas with a characteristic impedance of 50 Ω .

Important practices to observe when designing a transmission line are:

- Keep all transmission lines to a minimum length for best signal performance.
- Use RF components that also operate at a 50 Ω impedance.
- If the radio is not on the same PCB as the antenna the microstrip should be terminated in a connector enabling a shielded cable to complete the antenna connection to the radio, as exemplified on the ANT-W63-MSA-TH1 evaluation board.
- For designs subject to significant electromagnetic interference, a coplanar waveguide transmission line may be used on the PCB.

The design of a PCB transmission line can be aided by many commercially available software packages which can calculate the correct transmission line width and gap dimensions based upon the PCB thickness and dielectric constant used.

Reflow Solder Profile

The ANT-W63-MSA-TH1 uses a typical RoHS solder reflow profile. Refer to application note AN-00504 on the Linx website for more information.

Website: <http://linxtechnologies.com>
Linx Offices: 159 Ort Lane, Merlin, OR, US 97532
Phone: +1 (541) 471-6256
E-MAIL: info@linxtechnologies.com

Linx Technologies reserves the right to make changes to the product(s) or information contained herein without notice. No liability is assumed as a result of their use or application. No rights under any patent accompany the sale of any such product(s) or information.

Wireless Made Simple is a registered trademark of Linx Acquisitions LLC. Other product and brand names may be trademarks or registered trademarks of their respective owners.

Copyright © 2022 Linx Technologies

All Rights Reserved

Doc# DS22165-246ANT Replaces (DS22160-246ANT)

