

## N-Channel 60 V (D-S) MOSFET

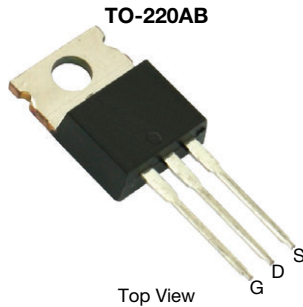

PRODUCT SUMMARY	
$V_{DS}$ (V)	60
$R_{DS(on)}$ max. ( $\Omega$ ) at $V_{GS} = 10$ V	0.00200
$R_{DS(on)}$ max. ( $\Omega$ ) at $V_{GS} = 7.5$ V	0.00250
$Q_g$ typ. (nC)	141
$I_D$ (A)	150 <sup>d</sup>
Configuration	Single

### FEATURES

- TrenchFET® power MOSFET
- Maximum 175 °C junction temperature
- Very low  $Q_{gd}$  reduces power loss from passing through  $V_{plateau}$
- 100 %  $R_g$  and UIS tested
- Material categorization: for definitions of compliance please see [www.vishay.com/doc?99912](http://www.vishay.com/doc?99912)



**RoHS**  
COMPLIANT  
HALOGEN  
FREE

### APPLICATIONS

- Power supply  
- Secondary synchronous rectification
- DC/DC converter
- Power tools
- Motor drive switch
- DC/AC inverter
- Battery management
- OR-ing / e-fuse

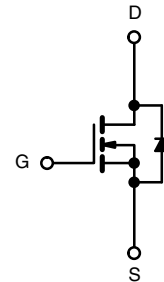

N-Channel MOSFET

ORDERING INFORMATION	
Package	TO-220
Lead (Pb)-free and halogen-free	SUP50010E-GE3

ABSOLUTE MAXIMUM RATINGS ( $T_C = 25$ °C, unless otherwise noted)			
PARAMETER	SYMBOL	LIMIT	UNIT
Drain-source voltage	$V_{DS}$	60	V
Gate-source voltage	$V_{GS}$	$\pm 20$	
Continuous drain current ( $T_J = 150$ °C)	$I_D$	$T_C = 25$ °C	150 <sup>d</sup>
		$T_C = 70$ °C	150 <sup>d</sup>
Pulsed drain current ( $t = 100$ $\mu$ s)	$I_{DM}$	500	A
Avalanche current	$I_{AS}$	60	
Single avalanche energy <sup>a</sup>	$E_{AS}$	180	mJ
Maximum power dissipation <sup>a</sup>	$P_D$	$T_C = 25$ °C	375 <sup>b</sup>
		$T_C = 125$ °C	125 <sup>b</sup>
Operating junction and storage temperature range	$T_J, T_{stg}$	-55 to +175	°C

THERMAL RESISTANCE RATINGS			
PARAMETER	SYMBOL	LIMIT	UNIT
Junction-to-ambient (PCB mount) <sup>c</sup>	$R_{thJA}$	40	°C/W
Junction-to-case (drain)	$R_{thJC}$	0.4	

### Notes

- Duty cycle  $\leq 1$  %
- See SOA curve for voltage derating
- When mounted on 1" square PCB (FR4 material)
- Package limited



SPECIFICATIONS ( $T_J = 25\text{ }^\circ\text{C}$ , unless otherwise noted)						
PARAMETER	SYMBOL	TEST CONDITIONS	MIN.	TYP.	MAX.	UNIT
<b>Static</b>						
Drain-source breakdown voltage	$V_{DS}$	$V_{GS} = 0\text{ V}, I_D = 250\text{ }\mu\text{A}$	60	-	-	V
Gate threshold voltage	$V_{GS(th)}$	$V_{DS} = V_{GS}, I_D = 250\text{ }\mu\text{A}$	2	-	4	
Gate-body leakage	$I_{GSS}$	$V_{DS} = 0\text{ V}, V_{GS} = \pm 20\text{ V}$	-	-	$\pm 250$	nA
Zero gate voltage drain current	$I_{DSS}$	$V_{DS} = 60\text{ V}, V_{GS} = 0\text{ V}$	-	-	1	$\mu\text{A}$
		$V_{DS} = 60\text{ V}, V_{GS} = 0\text{ V}, T_J = 125\text{ }^\circ\text{C}$	-	-	150	
		$V_{DS} = 60\text{ V}, V_{GS} = 0\text{ V}, T_J = 175\text{ }^\circ\text{C}$	-	-	5	mA
On-state drain current <sup>a</sup>	$I_{D(on)}$	$V_{DS} \geq 10\text{ V}, V_{GS} = 10\text{ V}$	120	-	-	A
Drain-source on-state resistance <sup>a</sup>	$R_{DS(on)}$	$V_{GS} = 10\text{ V}, I_D = 30\text{ A}$	-	0.00166	0.00200	$\Omega$
		$V_{GS} = 7.5\text{ V}, I_D = 20\text{ A}$	-	0.00208	0.00250	
Forward transconductance <sup>a</sup>	$g_{fs}$	$V_{DS} = 15\text{ V}, I_D = 30\text{ A}$	-	120	-	S
<b>Dynamic <sup>b</sup></b>						
Input capacitance	$C_{iss}$	$V_{GS} = 0\text{ V}, V_{DS} = 30\text{ V}, f = 1\text{ MHz}$	-	10 895	-	$\mu\text{F}$
Output capacitance	$C_{oss}$		-	2420	-	
Reverse transfer capacitance	$C_{rss}$		-	85	-	
Total gate charge <sup>c</sup>	$Q_g$	$V_{DS} = 30\text{ V}, V_{GS} = 10\text{ V}, I_D = 20\text{ A}$	-	141	212	nC
Gate-source charge <sup>c</sup>	$Q_{gs}$		-	43.6	-	
Gate-drain charge <sup>c</sup>	$Q_{gd}$		-	19.1	-	
Output charge	$Q_{oss}$	$V_{DS} = 50\text{ V}, V_{GS} = 0\text{ V}$	-	143	215	
Gate resistance	$R_g$	$f = 1\text{ MHz}$	0.24	1.2	2.4	$\Omega$
Turn-on delay time <sup>c</sup>	$t_{d(on)}$	$V_{DD} = 30\text{ V}, R_L = 3\text{ }\Omega$ $I_D \cong 10\text{ A}, V_{GEN} = 10\text{ V}, R_g = 1\text{ }\Omega$	-	28	56	ns
Rise time <sup>c</sup>	$t_r$		-	12	24	
Turn-off delay time <sup>c</sup>	$t_{d(off)}$		-	50	100	
Fall time <sup>c</sup>	$t_f$		-	13	26	
<b>Drain-Source Body Diode Ratings and Characteristics <sup>b</sup> (<math>T_C = 25\text{ }^\circ\text{C}</math>)</b>						
Pulsed current ( $t = 100\text{ }\mu\text{s}$ )	$I_{SM}$		-	-	250	A
Forward voltage <sup>a</sup>	$V_{SD}$	$I_F = 10\text{ A}, V_{GS} = 0\text{ V}$	-	0.8	1.5	V
Reverse recovery time	$t_{rr}$	$I_F = 34\text{ A}, di/dt = 100\text{ A}/\mu\text{s}$	-	75	150	ns
Peak reverse recovery charge	$I_{RM(REC)}$		-	2.8	5.6	A
Reverse recovery charge	$Q_{rr}$		-	0.12	0.24	$\mu\text{C}$
Reverse recovery fall time	$t_a$		-	38	-	ns
Reverse recovery rise time	$t_b$		-	37	-	

**Notes**

- a. Pulse test; pulse width  $\leq 300\text{ }\mu\text{s}$ , duty cycle  $\leq 2\%$   
b. Guaranteed by design, not subject to production testing  
c. Independent of operating temperature

Stresses beyond those listed under "Absolute Maximum Ratings" may cause permanent damage to the device. These are stress ratings only, and functional operation of the device at these or any other conditions beyond those indicated in the operational sections of the specifications is not implied. Exposure to absolute maximum rating conditions for extended periods may affect device reliability.



TYPICAL CHARACTERISTICS (T<sub>A</sub> = 25 °C, unless otherwise noted)

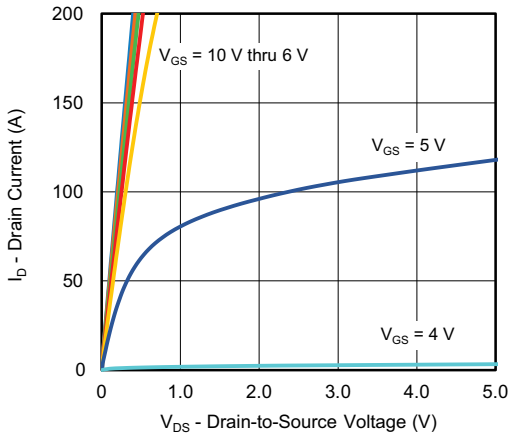

Output Characteristics

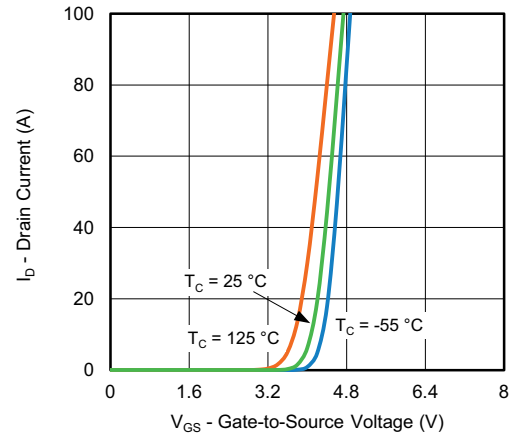

Transfer Characteristics

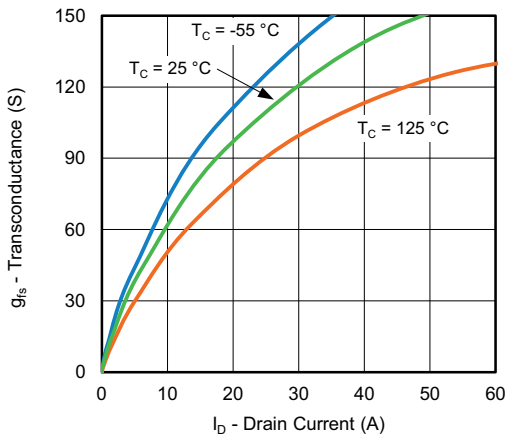

Transconductance

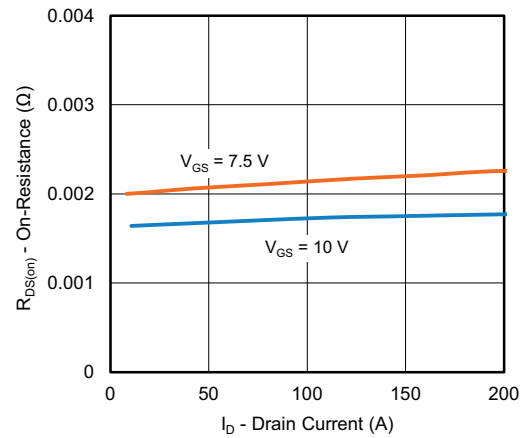

On-Resistance vs. Drain Current

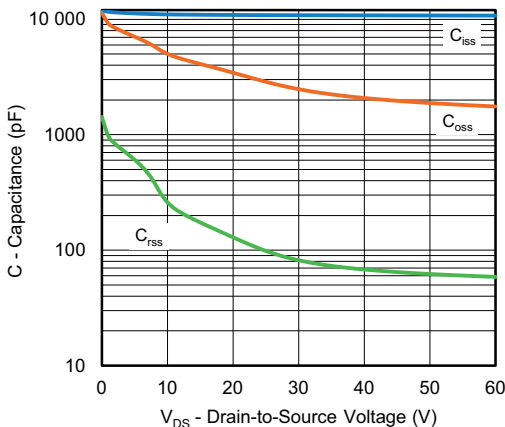

Capacitance

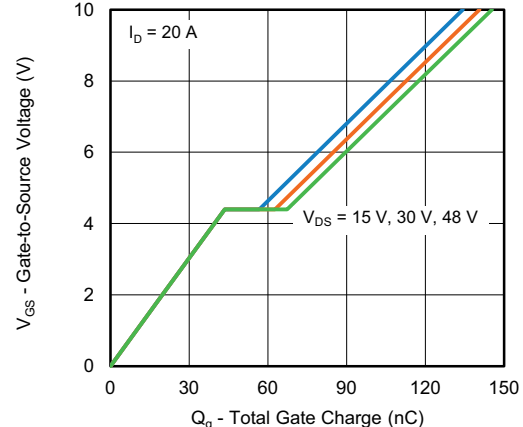

Gate Charge



TYPICAL CHARACTERISTICS (T<sub>A</sub> = 25 °C, unless otherwise noted)

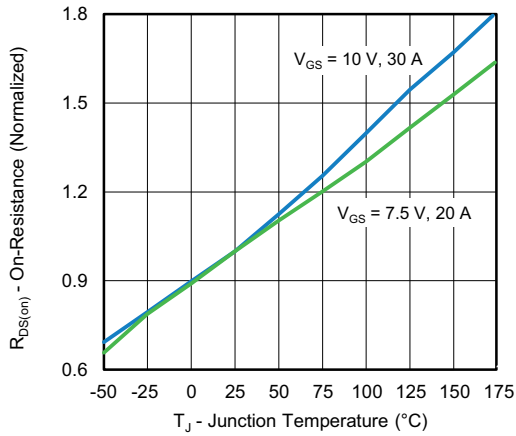

On-Resistance vs. Junction Temperature

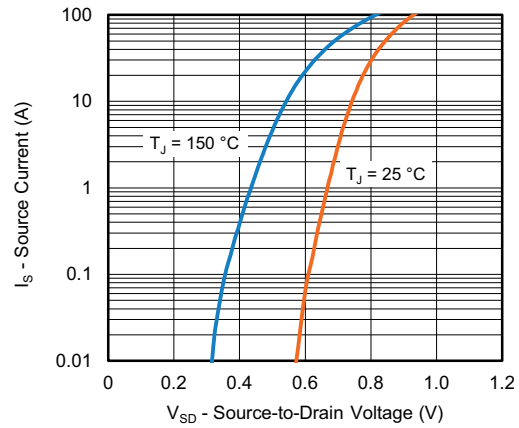

Source Drain Diode Forward Voltage

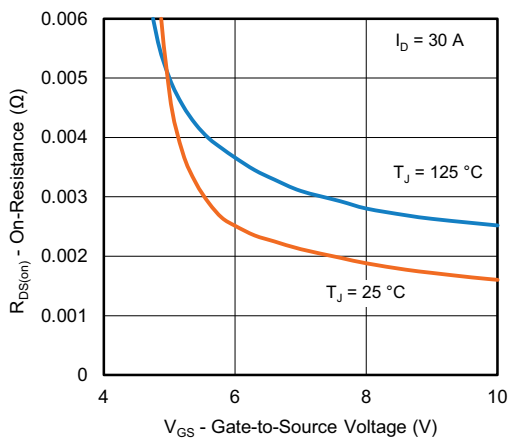

On-Resistance vs. Gate-to-Source Voltage

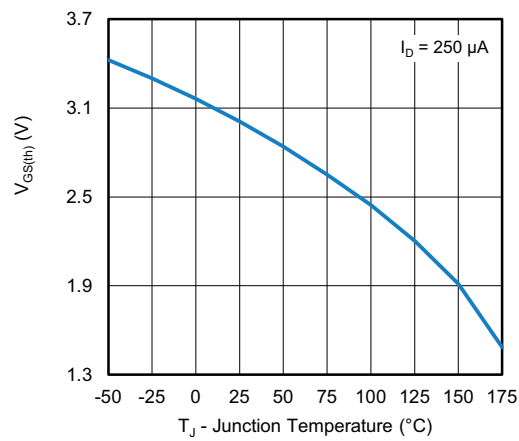

Threshold Voltage

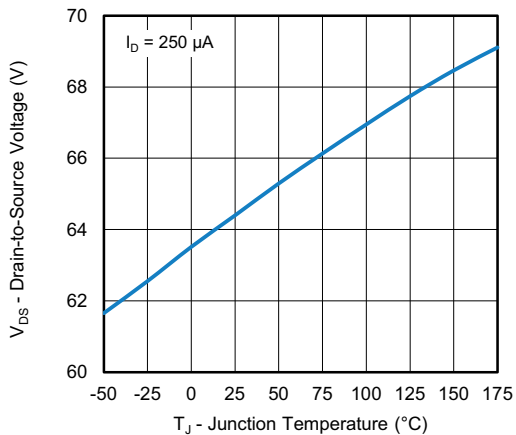

Drain Source Breakdown vs. Junction Temperature

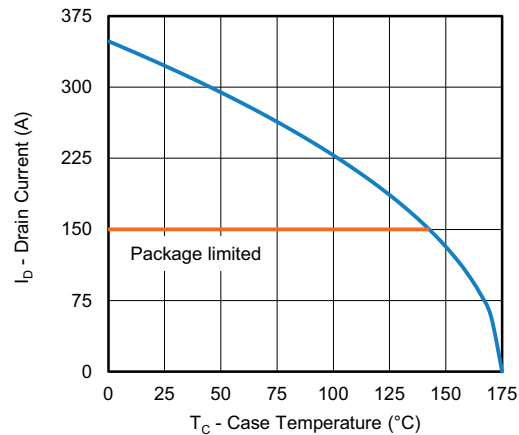

Current De-rating



**THERMAL RATINGS** ( $T_A = 25\text{ }^\circ\text{C}$ , unless otherwise noted)

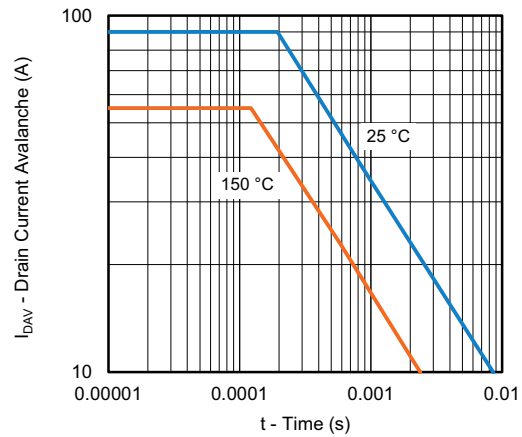
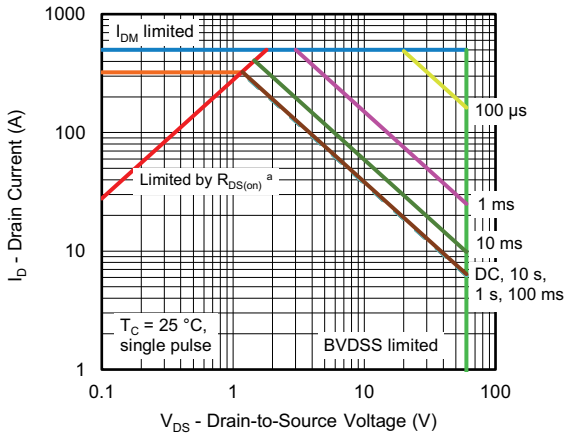

**Note**

a.  $V_{GS} >$  minimum  $V_{GS}$  at which  $R_{DS(on)}$  is specified

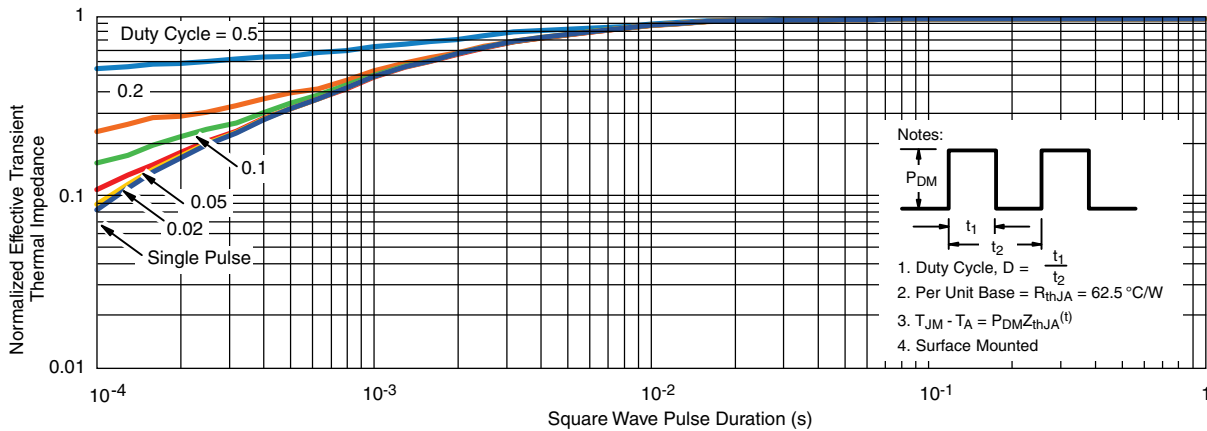

**Note**

- The characteristics shown in the two graphs
    - Normalized Transient Thermal Impedance Junction to Ambient (25  $^\circ\text{C}$ )
    - Normalized Transient Thermal Impedance Junction to Case (25  $^\circ\text{C}$ )
- are given for general guidelines only to enable the user to get a "ball park" indication of part capabilities. The data are extracted from single pulse transient thermal impedance characteristics which are developed from empirical measurements. The latter is valid for the part mounted on printed circuit board - FR4, size 1" x 1" x 0.062", double sided with 2 oz. copper, 100 % on both sides. The part capabilities can widely vary depending on actual application parameters and operating conditions

Vishay Siliconix maintains worldwide manufacturing capability. Products may be manufactured at one of several qualified locations. Reliability data for Silicon Technology and Package Reliability represent a composite of all qualified locations. For related documents such as package / tape drawings, part marking, and reliability data, see [www.vishay.com/ppg?79578](http://www.vishay.com/ppg?79578).



TO-220AB



DIM.	MILLIMETERS		INCHES	
	MIN.	MAX.	MIN.	MAX.
A	4.25	4.65	0.167	0.183
b	0.69	1.01	0.027	0.040
b(1)	1.20	1.73	0.047	0.068
c	0.36	0.61	0.014	0.024
D	14.85	15.49	0.585	0.610
D2	12.19	12.70	0.480	0.500
E	10.04	10.51	0.395	0.414
e	2.41	2.67	0.095	0.105
e(1)	4.88	5.28	0.192	0.208
F	1.14	1.40	0.045	0.055
H(1)	6.09	6.48	0.240	0.255
J(1)	2.41	2.92	0.095	0.115
L	13.35	14.02	0.526	0.552
L(1)	3.32	3.82	0.131	0.150
$\varnothing P$	3.54	3.94	0.139	0.155
Q	2.60	3.00	0.102	0.118

ECN: T14-0413-Rev. P, 16-Jun-14  
DWG: 5471

Note

\* M = 1.32 mm to 1.62 mm (dimension including protrusion)  
Heatsink hole for HVM

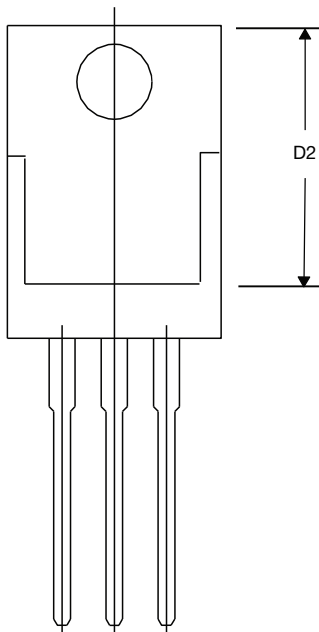



## Disclaimer

ALL PRODUCT, PRODUCT SPECIFICATIONS AND DATA ARE SUBJECT TO CHANGE WITHOUT NOTICE TO IMPROVE RELIABILITY, FUNCTION OR DESIGN OR OTHERWISE.

Vishay Intertechnology, Inc., its affiliates, agents, and employees, and all persons acting on its or their behalf (collectively, "Vishay"), disclaim any and all liability for any errors, inaccuracies or incompleteness contained in any datasheet or in any other disclosure relating to any product.

Vishay makes no warranty, representation or guarantee regarding the suitability of the products for any particular purpose or the continuing production of any product. To the maximum extent permitted by applicable law, Vishay disclaims (i) any and all liability arising out of the application or use of any product, (ii) any and all liability, including without limitation special, consequential or incidental damages, and (iii) any and all implied warranties, including warranties of fitness for particular purpose, non-infringement and merchantability.

Statements regarding the suitability of products for certain types of applications are based on Vishay's knowledge of typical requirements that are often placed on Vishay products in generic applications. Such statements are not binding statements about the suitability of products for a particular application. It is the customer's responsibility to validate that a particular product with the properties described in the product specification is suitable for use in a particular application. Parameters provided in datasheets and / or specifications may vary in different applications and performance may vary over time. All operating parameters, including typical parameters, must be validated for each customer application by the customer's technical experts. Product specifications do not expand or otherwise modify Vishay's terms and conditions of purchase, including but not limited to the warranty expressed therein.

Hyperlinks included in this datasheet may direct users to third-party websites. These links are provided as a convenience and for informational purposes only. Inclusion of these hyperlinks does not constitute an endorsement or an approval by Vishay of any of the products, services or opinions of the corporation, organization or individual associated with the third-party website. Vishay disclaims any and all liability and bears no responsibility for the accuracy, legality or content of the third-party website or for that of subsequent links.

Except as expressly indicated in writing, Vishay products are not designed for use in medical, life-saving, or life-sustaining applications or for any other application in which the failure of the Vishay product could result in personal injury or death. Customers using or selling Vishay products not expressly indicated for use in such applications do so at their own risk. Please contact authorized Vishay personnel to obtain written terms and conditions regarding products designed for such applications.

No license, express or implied, by estoppel or otherwise, to any intellectual property rights is granted by this document or by any conduct of Vishay. Product names and markings noted herein may be trademarks of their respective owners.