

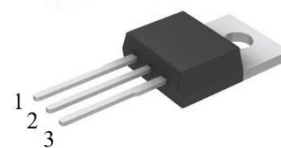

P3M173K0T3 SiC MOS N-Channel Enhancement Mode

V_{RRM}	=	1700V
I_D	=	4 A
$I_D (100^\circ\text{C})$	=	3 A
$R_{DS(on)}$	=	3 Ω

SiC MOS P3M173K0T3 N-Channel Enhancement Mode



Features

- High Blocking Voltage with Low On-Resistance
- High-Frequency Operation
- Ultra-Small Q_{gd}
- 100% UIS tested

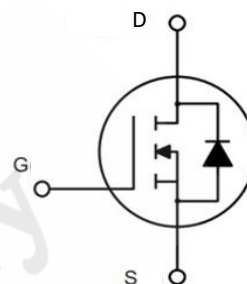

Standards Benefits

- Improve System Efficiency
- Increase Power Density
- Reduce Heat Sink Requirements
- Reduction of System Cost

TO-220-3

Gate	1
Drain	2
Source	3

Application

- Solar Inverters
- EV Battery Chargers
- High Voltage DC/DC Converters
- Switch Mode Power Supplies



Order Information

Part number	Package	Marking
P3M173K0T3	TO-220-3	P3M173K0T3



Contents

Features.....	1
Standards Benefits	1
Application.....	1
Order Information	1
Contents.....	2
1. Maximum Ratings.....	3
2. Electrical Characteristics	4
3. Reverse Diode Characteristics	6
4. Thermal Characteristics.....	6
5. Typical Performance	7
6. Package Outlines.....	11

PNJ Preliminary



1. Maximum Ratings

At $T_J = 25^\circ\text{C}$, unless specified otherwise

Parameter	Symbol	Value	Unit	Test Conditions
Drain - Source Voltage	V_{DSmax}	1700	V	$V_{GS} = 0V$ $I_D = 100\mu A$
Gate - Source Voltage (Dynamic)	V_{GSmax}	-8 / +19	V	AC ($f > 1\text{Hz}$)
Gate - Source Voltage (Static)	V_{GSop}	-3 / +15	V	Static
Continuous Drain Current	I_D	4	A	$V_{GS} = 15V$ $T_C = 25^\circ\text{C}$
		3		$V_{GS} = 15V$ $T_C = 100^\circ\text{C}$
Power Dissipation	P_D	75	W	
Operating Junction Temperature	T_J	-55 To +175	$^\circ\text{C}$	
Storage Temperature	T_{stg}	-55 To +175	$^\circ\text{C}$	
Solder Temperature	T_L	260	$^\circ\text{C}$	
Mounting Torque	M_d	1 8.8	Nm lbf-in	M3 or 6-32 screw



2. Electrical Characteristics

At $T_J = 25^\circ\text{C}$, unless specified otherwise

Parameter	Symbol	Value			Unit	Test Conditions
		Min.	Typ.	Max.		
Drain-Source Breakdown Voltage	$V_{(BR)DSS}$	1700	/	/	V	$V_{GS} = 0V$ $I_D = 0.1mA$
Gate Threshold Voltage	$V_{GS(th)}$	1.8	2.2	/	V	$V_{DS} = V_{GS}$ $I_D = 0.6mA$ $T_J = 25^\circ\text{C}$
		/	1.45	/	V	$V_{DS} = V_{GS}$ $I_D = 0.6mA$ $T_J = 175^\circ\text{C}$
Reverse Bias Drain Current	I_{DSS}	/	1	100	μA	$V_{GS} = 0V$ $V_{DS} = 1700V$
Gate-Source Leakage Current	I_{GSS}	/	2	125	nA	$V_{GS} = 15V$ $V_{DS} = 0V$
Drain-Source On-State Resistance	$R_{DS(on)}$	/	2.5	/	Ω	$V_{GS} = 12V$ $I_D = 0.6A$
		/	2	2.6	Ω	$V_{GS} = 15V$ $I_D = 0.6A$ $T_J = 25^\circ\text{C}$
		/	2.3	/	Ω	$V_{GS} = 15V$ $I_D = 0.6A$ $T_J = 125^\circ\text{C}$
		/	2.8	/	Ω	$V_{GS} = 15V$ $I_D = 0.6A$ $T_J = 175^\circ\text{C}$
Transconductance	g_{fs}	/	0.35	/	S	$V_{DS} = 20V$ $I_{DS} = 0.6A$ $T_J = 25^\circ\text{C}$
		/	0.4	/	S	$V_{DS} = 20V$ $I_{DS} = 0.6A$ $T_J = 175^\circ\text{C}$



P3M173K0T3 SiC MOS N-Channel Enhancement Mode

Parameter	Symbol	Value			Unit	Test Conditions
		Min.	Typ.	Max.		
Input Capacitance	C_{iss}	/	116	/	pF	$V_{GS} = 0V$ $V_{DS} = 1000V$ $F = 1MHz$ $V_{AC} = 25mV$
Output Capacitance	C_{oss}	/	12	/	pF	
Reverse Transfer Capacitance	C_{rss}	/	4.3	/	pF	
Coss Stored Energy	E_{oss}	/	8.7	/	μJ	
Turn-on Energy	E_{on}	/	50.6	/	μJ	$V_{DS} = 1200V$ $V_{GS} = -3/15V$ $I_{DS} = 0.5A$ $R_G = 1\Omega$
Turn-off Energy	E_{off}	/	14.9	/		
Turn-On Delay Time	$T_{d(on)}$	/	7.2	/	ns	$V_{DS} = 1200V$ $V_{GS} = -3/15V$ $I_{DS} = 0.5A$ $R_G = 1\Omega$
Rise Time	T_r	/	21.2	/		
Turn-Off Delay Time	$T_{d(off)}$	/	6.0	/		
Fall Time	T_f	/	61.6	/		
Internal Gate Resistance	$R_{G(int)}$	/	65	/	Ω	$f = 1MHz$ $V_{AC} = 25mV$
Gate to Source Charge	Q_{gs}	/	1.05	/	nC	$V_{DS} = 1200V$ $I_{DS} = 0.6A$ $V_{GS} = -3 \text{ to } 15V$ $I_G = 2mA$
Gate to Drain Charge	Q_{gd}	/	1.55	/		
Total Gate Charge	Q_g	/	3.79	/		

3. Reverse Diode Characteristics

At $T_J=25\text{ }^\circ\text{C}$, unless specified otherwise

Parameter	Symbol	Value		Unit	Test Conditions
		Typ.	Max.		
Diode Forward Voltage	V_{SD}	4.6	/	V	$V_{GS} = -3V$ $I_{SD} = 0.3A$ $T_J = 25^\circ C$
		4.3	/	V	$V_{GS} = -3V$ $I_{SD} = 0.3A$ $T_J = 175^\circ C$
Continuous Diode Forward Current	I_S	5	/	A	$V_{GS} = -3V$ $T_J = 25^\circ C$
Reverse Recover Time	t_{rr}	20.8	/	ns	$V_{GS} = -3V$ $I_{SD} = 2A$ $V_R = 1200V$ $d_{if}/d_t = 500A/\mu s$ $T_J = 25^\circ C$
Reverse Recovery Charge	Q_{rr}	60	/	nC	
Peak Reverse Recovery Current	I_{rrm}	4.8	/	A	

4. Thermal Characteristics

Parameter	Symbol	Value	Unit
Thermal Resistance from Junction to Case	$R_{\theta JC}$	2.0	$^\circ\text{C}/\text{W}$

5. Typical Performance

At $T_J = 25^\circ\text{C}$, unless specified otherwise

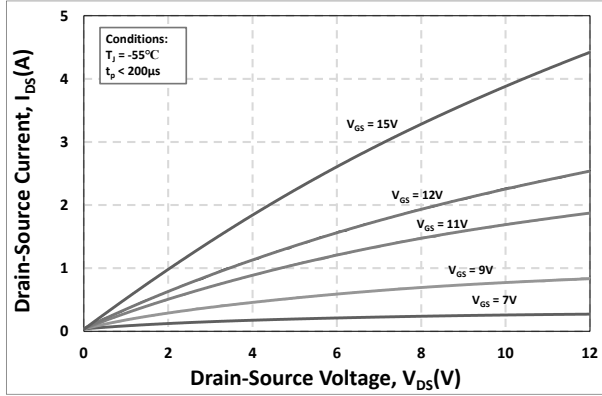

Figure 1. Output Characteristics $T_J = -55^\circ\text{C}$

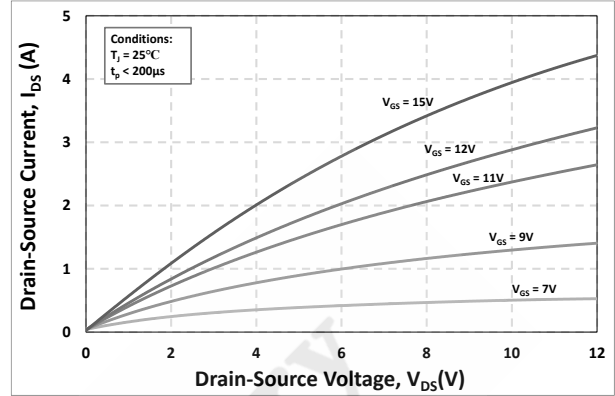

Figure 2. Output Characteristics $T_J = 25^\circ\text{C}$

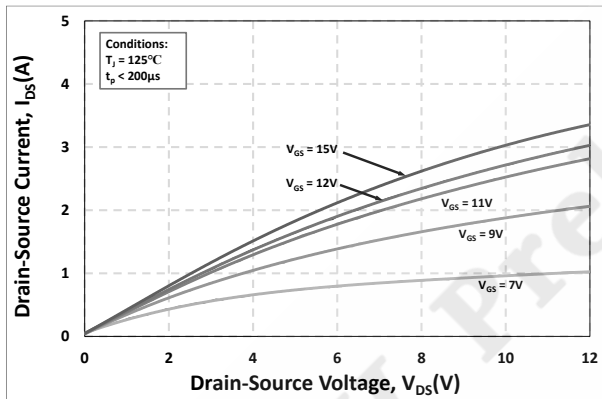

Figure 3. Output Characteristics $T_J = 125^\circ\text{C}$

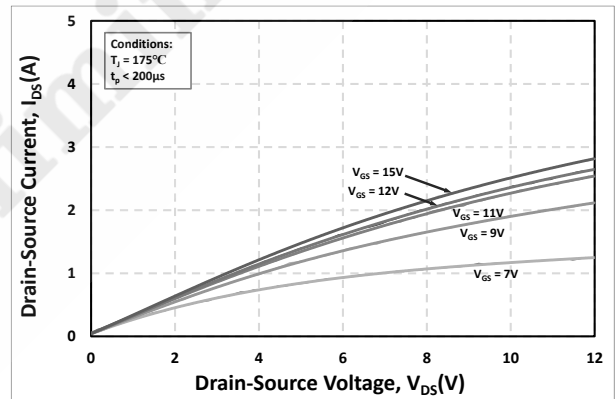

Figure 4. Output Characteristics $T_J = 175^\circ\text{C}$

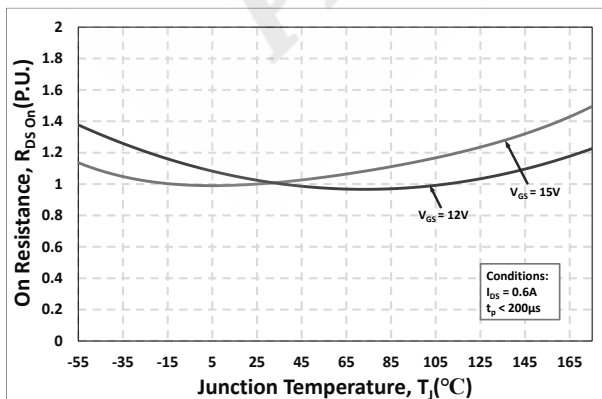

Figure 5. Normalized On-Resistance vs. Temperature

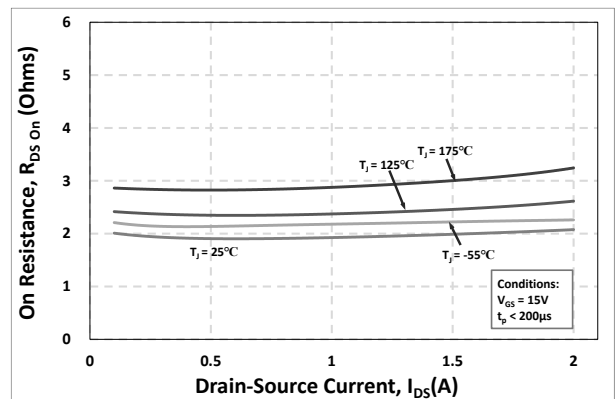

Figure 6. On-Resistance vs. Drain Current Various Temperatures

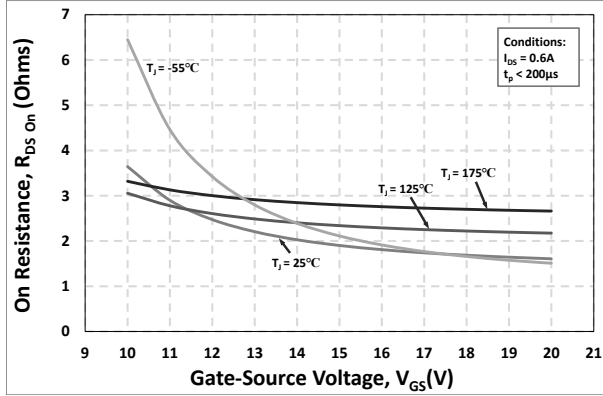

Figure 7. On-Resistance vs. Gate-Source Voltage

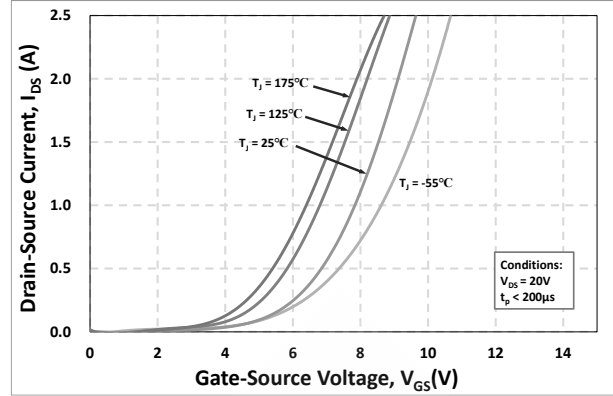

Figure 8. Transfer Characteristic for Various Junction Temperatures

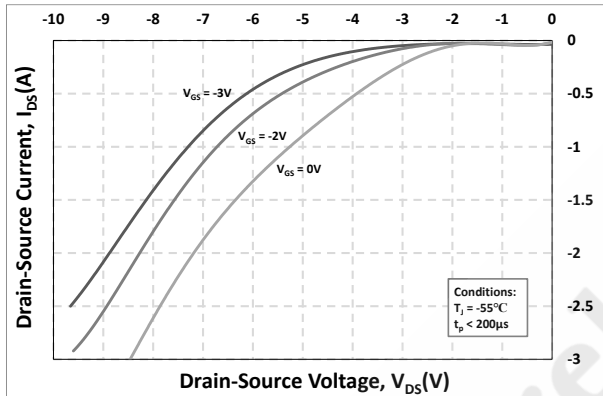

Figure 9. Body Diode Characteristic at -55°C

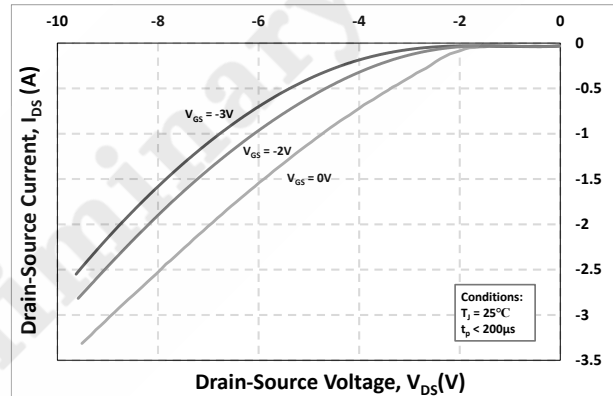

Figure 10. Body Diode Characteristic at 25°C

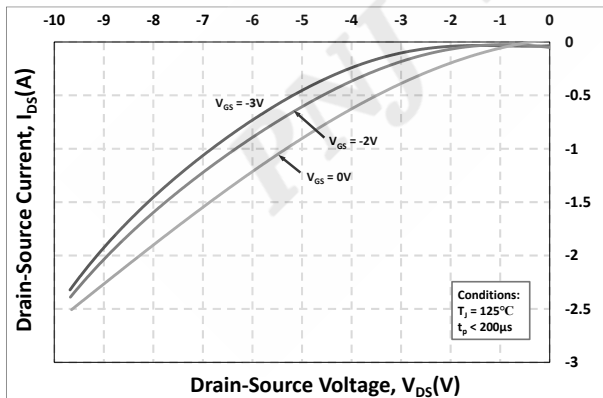

Figure 11. Body Diode Characteristic at 125°C

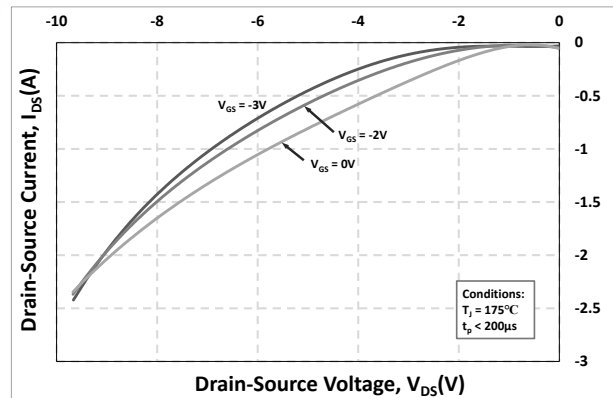

Figure 12. Body Diode Characteristic at 175°C

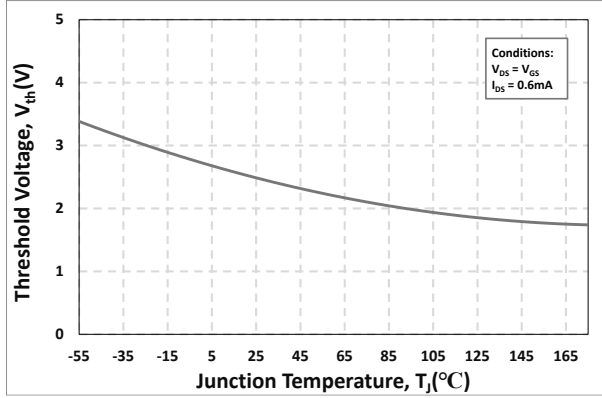

Figure 13. Threshold Voltage vs. Temperatures

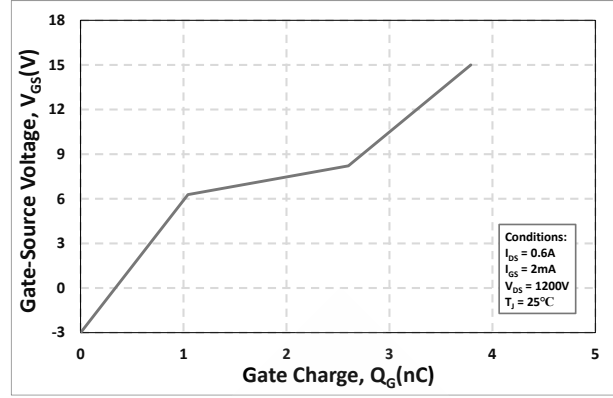

Figure 14. Gate Charge Characteristics

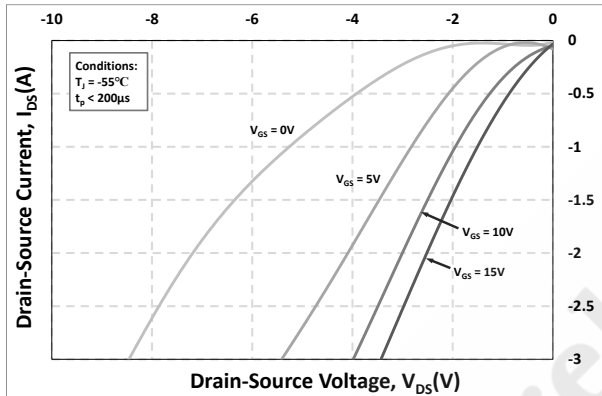

Figure 15. 3rd Quadrant Characteristic at -55°C

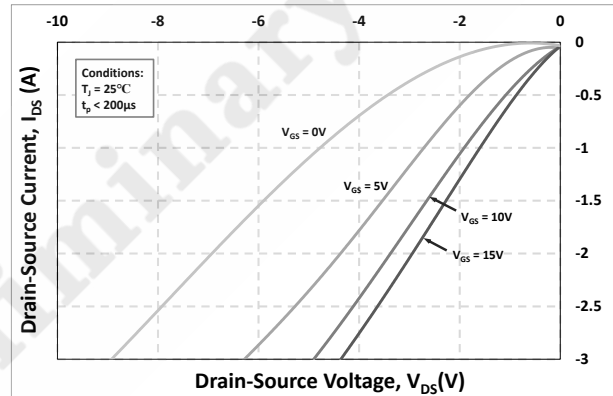

Figure 16. 3rd Quadrant Characteristic at 25°C

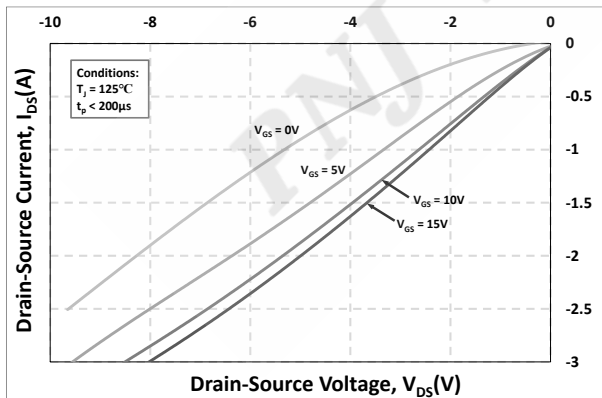

Figure 17. 3rd Quadrant Characteristic at 125°C

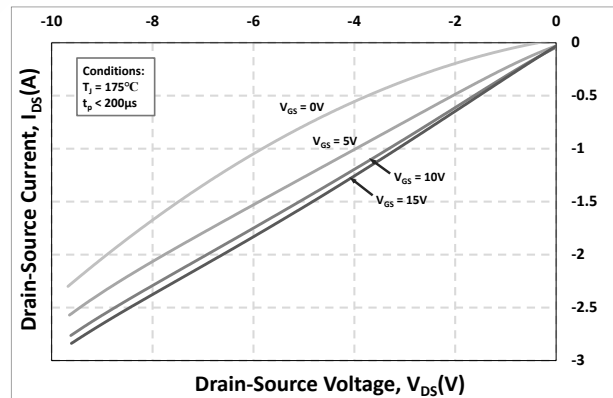

Figure 18. 3rd Quadrant Characteristic at 175°C

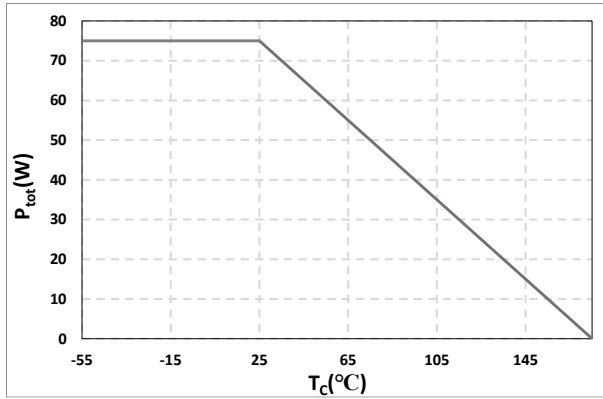

Figure 19. Maximum Power Dissipation Derating vs. Case Temperature

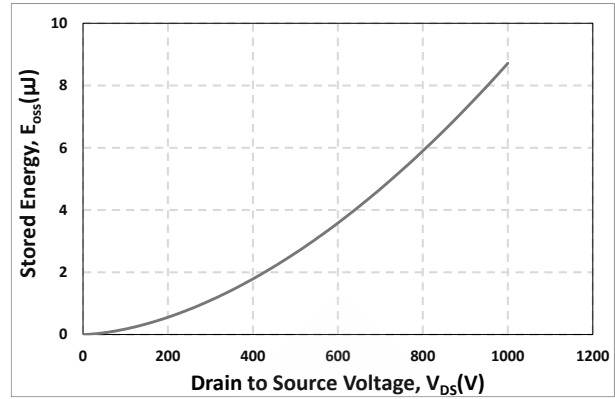

Figure 20. Output Capacitor Stored Energy

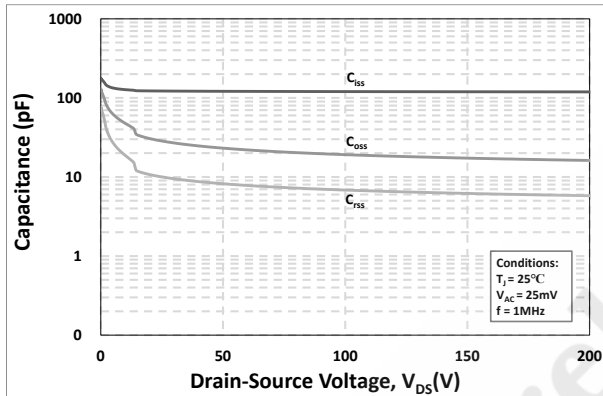

Figure 21. Capacitances vs. Drain-Source Voltage (0-200V)

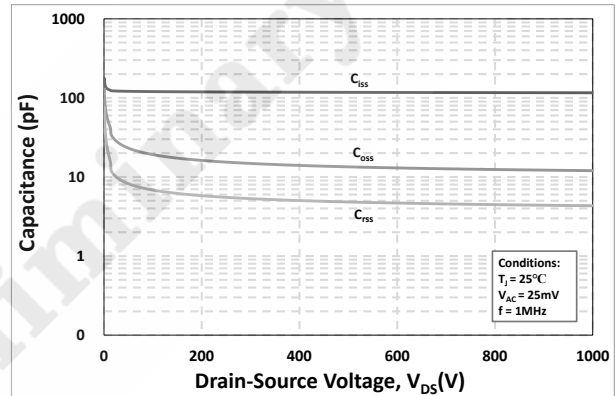
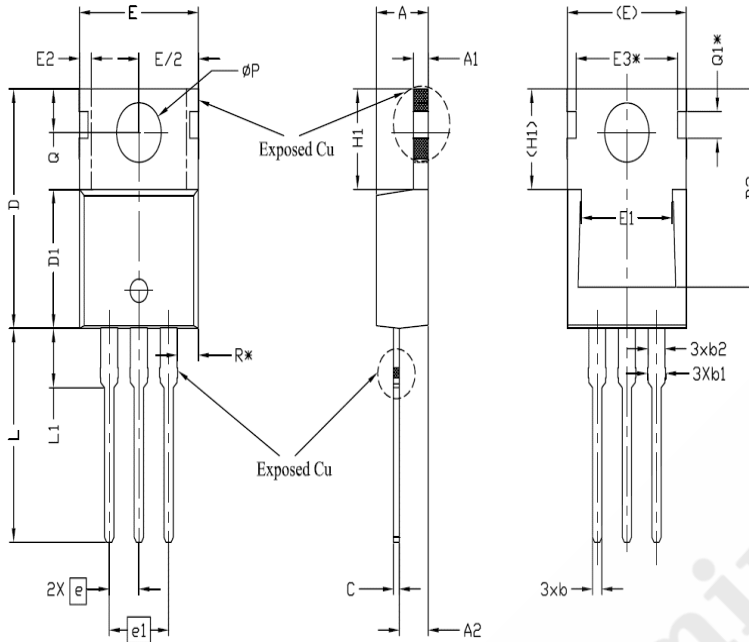

Figure 22. Capacitances vs. Drain-Source Voltage (0-1000V)

6. Package Outlines



SYMBOL	DIMENSIONS			NOTES
	MIN.	NOM.	MAX.	
A	4.24	4.44	4.64	
A1	1.15	1.27	1.40	
A2	2.30	2.48	2.70	
b	0.70	0.80	0.90	
b1	1.20	1.55	1.75	
b2	1.20	1.45	1.70	
c	0.40	0.50	0.60	
D	14.70	15.37	16.00	4
D1	8.82	8.92	9.02	
D2	12.43	12.73	12.83	5
E	9.96	10.16	10.36	4,5
E1	6.86	7.77	8.89	5
E2	-	-	0.76	6
E3*	8.70REF.			
e	2.54BSC			
e1	5.08BSC			
H1	6.30	6.45	6.60	5,6
L	13.47	13.72	13.97	
L1	3.60	3.80	4.00	
ØP	3.75	3.84	3.93	
Q	2.60	2.80	3.00	
Q1*	1.73REF.			
R*	1.82REF.			

Drawing and dimensions

PNJ Preliminary