

1

2

3

4

5

RoHS Compliant

Specifications:

Current Rating:4A(2~5Pin)AC/DC
 Voltage Rating:250V(2~4Pin);60V(5Pin)AC/DC
 Contact Resistance:5m ohm. Max.
 Insulation Resistance:100M ohm. Min.
 Withstanding Voltage:500V AC/Minute
 Operating Temperature Range:-40°C ~ +100°C
 Waterproof Rate:IP67
 Material and Finish
 See Table
 How to Order
 M12-XXS-FD-PBSX

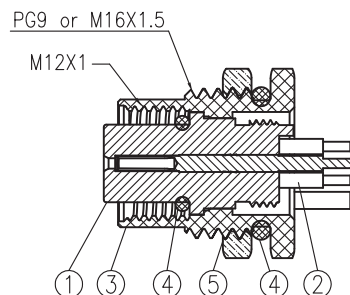
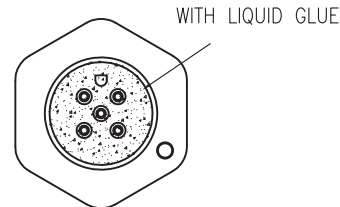
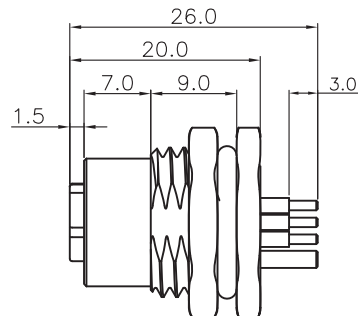
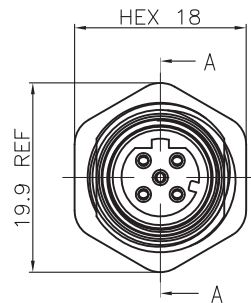

Section A-A

Panel Lock Thread
 1:PG9
 2:M16
 With Shielding
 Panel Mount PCB Dip
 Front Fastened D Coding Die Casting
 Socket
 No.of Contacts
 M12

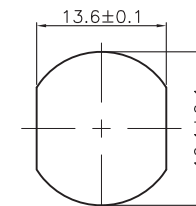

M16 Recommended
 Panel CUT-Out
 Thickness:4.0mm

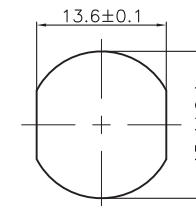

PG9 Recommended
 Panel CUT-Out
 Thickness:4.0mm

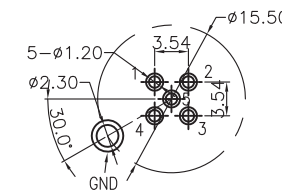

2~5P Recommended PCB Layout
 TOL:±0.05mm

Pin Assignments Front View

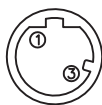

2Pin

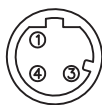

3Pin

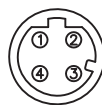

4Pin



5Pin

ITEM	Description	Material	Remark	Q'TY
1	Insulator	Nylon	UL94V-0 Black	1
2	Terminal	Copper Alloy	Gold Plated 1u"	2~5
3	Shell	Zinc Alloy	Nickel Plated 60u"	1
4	Seal ring	Silicone	Red	2
5	Nut	Copper Alloy	PG9 or M16 Nickel Plated 60u"	1

F				
E				
D				
C				
B				
A	27-MAR-2021		ANDREW	
REV	DATE	FILE	BY	

DRAWN:	ANDREW
CHECKED:	BILL
APPROVAL:	ANDREW
BILL	

GENERAL TOLERANCE:	.X=±0.3 .XX=±0.2
UNIT:	MM
SCALE:	1:1
SHEET:	1/1
PROJECTION:	



ON-SHORE TECHNOLOGY, INC.

DESCRIPTION:

M12 D CODE SOCKET STRAIGHT DIP TYPE

PART NO:

M12-XXS-FD-PBSX

A

B

C

D