

History of Version

Date (mm / dd / yyyy)	Ver.	Edi.	Description	Page	Design by
04/18/2017	01	001	New Drawing.	-	Howard
05/31/2017	01	002	New Sample	-	Howard
06/09/2017	02	003	Second Drawing Modify TP FPC Part area location	- Appendix	Howard
06/15/2017	02	004	Three Drawing Modify Backlight Characteristics	- 9	Howard
10/31/2017	02	005	Second Sample	-	Howard
11/28/2017	02	006	Increase dimension & T/P pin define	Appendix	Howard

Total: 28 Pages

Contents

1. SPECIFICATIONS

- 1.1 Features
- 1.2 Mechanical Specifications
- 1.3 Absolute Maximum Ratings
- 1.4 DC Electrical Characteristics
- 1.5 Optical Characteristics
- 1.6 Backlight Characteristics
- 1.7 Touch Panel Specification

2. MODULE STRUCTURE

- 2.1 Counter Drawing
- 2.2 Interface Pin Description
- 2.3 Timing Characteristics

3. QUALITY ASSURANCE SYSTEM

- 3.1 Quality Assurance Flow Chart
- 3.2 Inspection Specification

4. RELIABILITY TEST

- 4.1 Reliability Test Condition

5. PRECAUTION RELATING PRODUCT HANDLING

- 5.1 Safety
- 5.2 Handling
- 5.3 Storage
- 5.4 Terms of Warranty

Appendix : 1.LCM Drawing

2. Packing Specification

Note : For detailed information please refer to IC data sheet :
Primacy(TFT LCD): ILITEK: ILI6122M-9G / ILI5960-9G

1. SPECIFICATIONS

1.1 Features

Item	Standard Value
Display Resolution	800 * 3 (RGB) * 480 Dots
LCD Type	a-Si TFT , Normally white, Transmissive type
Touch Panel	True Multi-Touch Capacitive Touch Panel True Multi-touch with up to 5 Points of Absolution
Screen size(inch)	5.0 inch
Viewing Direction	6 O'clock
Surface treatment	Anti-Glare
Color configuration	RGB Vertical Strip
Backlight Type	White LED B/L
Weight	85 g
Interface	24 Bits RGB interface
ROHS	THIS PRODUCT CONFORMS THE ROHS OF PTC Detail information please refer website : http://www.powertip.com.tw/news_detail.php?Key=1&cID=1

1.2 Mechanical Specifications

Item	Standard Value	Unit
Outline Dimension	131.0(W) x 90.5 (L) x 5.0(H)	mm

LCD panel

Item	Standard Value	Unit
Viewing Area	110.0(L) * 66.8 (W)	mm
Active Area	108.0 (W) * 64.8 (L)	mm

Note : For detailed information please refer to LCM drawing

1.3 Absolute Maximum Ratings

Module

Item	Symbol	Condition	Min.	Max.	Unit	Remark
Power Supply for TFT Panel	VDD	GND=0	-0.3	4.5	V	-
Power Supply for Backlight Unit	VCC	GND=0	-0.3	+20.0	V	
Operating Temperature	T _{OP}	-	-20	70	°C	
Storage Temperature	T _{ST}	-	-30	80	°C	

The absolute maximum rating values of this product are not allowed to be exceeded at any times. Should a module be used with any of the absolute maximum ratings exceeded, the characteristics of the module may not be recovered, or in an extreme case, the module may be permanently destroyed.

1.4 DC Electrical Characteristics

Module

GND = 0V, Ta = 25 °C

Item	Symbol	Condition	Min.	Typ.	Max.	Unit
Power Supply for TFT Panel	VDD	GND=0V	3.0	3.3	3.6	V
Power Supply for Backlight Unit	VCC	GND=0V	5	12	15	V
Input Voltage for TFT Panel	V _{IH}	GND=0V	0.7VDD	-	VDD	V
	V _{IL}	GND=0V	0	-	0.3VDD	
Supply Current for TFT Panel	IDD	IDD@VDD=3.3V	-	120	180	mA
Supply Current for Backlight Unit	ICC	ICC@VCC=5V	-	400	600	
Supply Current for Backlight Unit	ICC	ICC@VCC=12V	-	150	250	
Input Voltage for PWM Signal	V _{PH}	GND=0V	1.2	-	-	V
	V _{PL}	GND=0V	-	-	0.4	V
Dimming Clock Rate	f _P	GND=0V	5	-	100	KHz

1.5 Optical Characteristics

TFT LCD Module

VDD= 3.3 V, Ta=25°C

Item		Symbol	Condition	Min.	Typ.	Max.	unit	-
Response time	Tr+Tf	25°C	-	-	24	36	ms	-
Viewing angle	Top	$\theta Y+$	CR \geq 10		60	-	Deg.	Note 4
	Bottom	$\theta Y-$			60	-		
	Left	$\theta X-$			60	-		
	Right	$\theta X+$			60	-		
Contrast ratio		CR		500	600	-	-	Note 3
Color of CIE Coordinate (With B/L & T/P)	White	X	Ta = 25°C $\theta X, \theta Y = 0^\circ$	0.26	0.31	0.36	-	Note1
		Y		0.28	0.33	0.38		
	Red	X		0.51	0.56	0.61		
		Y		0.28	0.33	0.38		
	Green	X		0.29	0.34	0.39		
		Y		0.54	0.59	0.64		
	Blue	X		0.09	0.14	0.19		
		Y		0.03	0.08	0.13		
Average Brightness Pattern=white display (With T/P)*1		IV	VCC=5V PWM="High" (Duty=100%)	680	850	-	cd/m ²	Note1
Uniformity (With T/P)*2		ΔB	VCC=5V PWM="High" (Duty=100%)	70	-	-	%	Note1

Note 1:

*1 : $\Delta B = B(\min) / B(\max) * 100\%$

*2 : Measurement Condition for Optical Characteristics:

a : Environment: $25^{\circ}\text{C} \pm 5^{\circ}\text{C}$ / $60 \pm 20\%$ R.H , no wind , dark room below 10 Lux at typical lamp current and typical operating frequency.

b : Measurement Distance: 500 ± 50 mm , ($\theta = 0^{\circ}$)

c : Equipment: TOPCON BM-7 fast , (field 1°) , after 10 minutes operation.

d : The uncertainty of the C.I.E coordinate measurement ± 0.01 , Average Brightness $\pm 4\%$

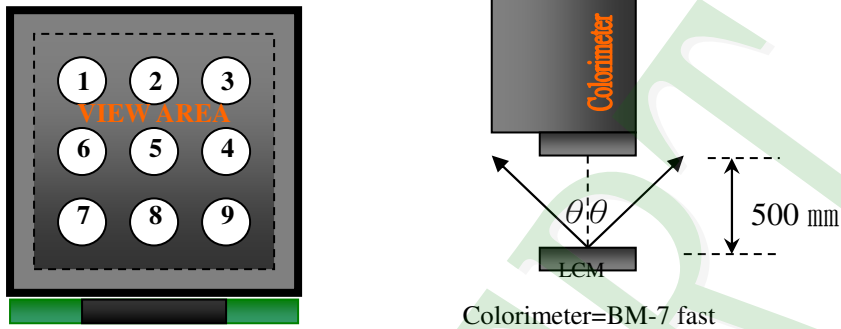

To be measured at the center area of panel with a viewing cone of 1° by Topcon luminance meter BM-7, after 10 minutes operation (module)

Note2: Definition of response time:

The output signals of photo detector are measured when the input signals are changed from "black" to "white"(falling time) and from "white" to "black"(rising time), respectively. The response time is defined as the time interval between the 10% and 90% of Amplitudes.

Refer to figure as below:

Normally White



Normally Black

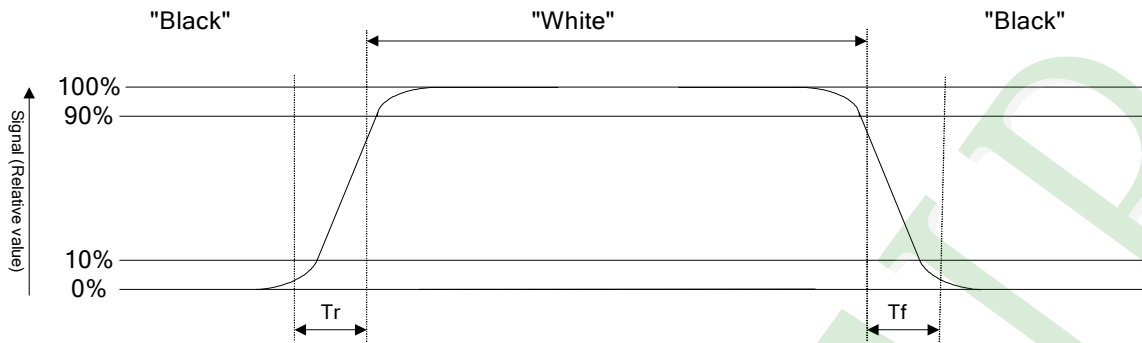

Note3: Definition of contrast ratio:

Contrast ratio is calculated with the following formula

$$\text{Contrast ratio (CR)} = \frac{\text{Photo detector output when LCD is at "White" state}}{\text{Photo detector output when LCD is at "Black" state}}$$

Note4: Definition of viewing angle:

Refer to figure as below:

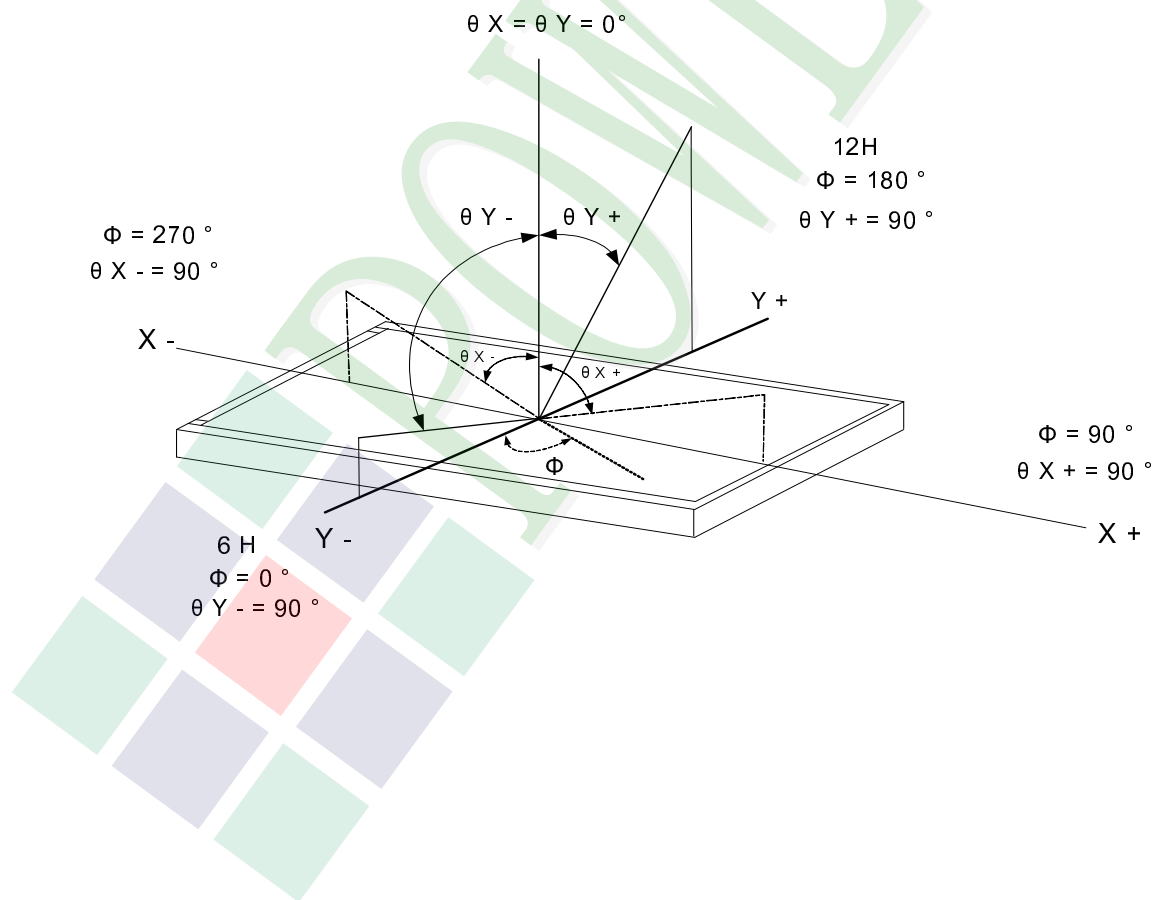

1.6 Backlight Characteristics

Maximum Ratings

Item	Symbol	Min.	Max.	Unit	Remark
LED Forward Current	I_F	210		mA	
LED Reverse Voltage	V_R	10		V	

Electrical / Optical Characteristics

Item	Symbol	Min.	Typ.	Max.	Unit	Remark
LED Voltage	V_L	16.2	18.0	19.2	V	Note1
LED Current	I_L	-	90	-	mA	-
LED life time	-	50,000	-	-	H _r	Note2

Note 1: The LED Supply Voltage is defined by the number of LED at $T_a=25^\circ\text{C}$ and $I_L=90\text{ mA}$.

Note 2: The "LED life time" is defined as the module brightness decrease to 50% original brightness at $T_a=25^\circ\text{C}$ and $I_L=90\text{ mA}$. The LED life time could be decreased if operating I_L is larger than 90 mA.

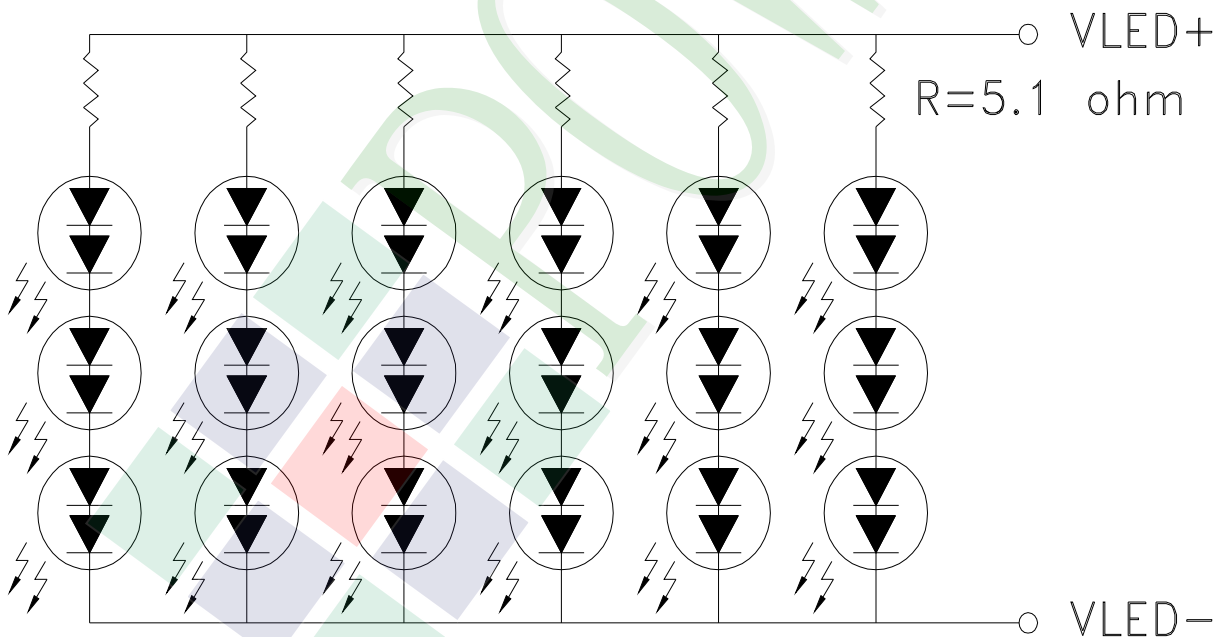

1.7 Touch Panel Characteristics

Features

Item	Standard Value
Touch Panel Size	5.0"
Touch type	True Multi-Touch Capacitive Touch Panel
Input Method	True Multi-touch with up to 5 Points of Absolution X and Y Coordinates
Output Interface	I ² C
IC	HYCON----HY4635

I²C Address

Bit 7	Bit 6	Bit 5	Bit 4	Bit 3	Bit 2	Bit 1	Bit 0
0	1	1	1	0	0	0	R/W

Bit 0: 0 for Write / 1 for Read

Mechanical Specifications

Item	Standard Value	Unit
Viewing Area	110 mm (W) x 66.8 mm (H)	mm

Absolute Maximum Ratings

Item	Symbol	Condition	Min.	Max.	Unit
Supply voltage	TPVDD	-	-0.2	4.0	V
Operating Temperature	T _{OP}	Non condenssing	-20	70	°C
Storage Temperature	T _{ST}	Non condenssing	-30	80	°C

DC Electrical Characteristics

Item	Symbol	Condition	Min.	Typ.	Max.	Unit
Power Supply Voltage	TPVDD	-	2.8	3.3	3.6	V
Input High Voltage	V _{IH}	-	-	-	0.7 * TPVDD	V
Input Low Voltage	V _{IL}	-	-	-	0.3 * TPVDD	V

Optical Characteristics

Item	Standard Value	Unit
Total light transmittance	85% or more	-
Hardness	≥6H	-

Touch Panel IC Read/Write description & Register Mapping

Reference : HY463x Application Notes.

2. MODULE STRUCTURE

2.1 Counter Drawing

2.1.1 LCM Mechanical Diagram

* See Appendix

2.1.2 Block Diagram

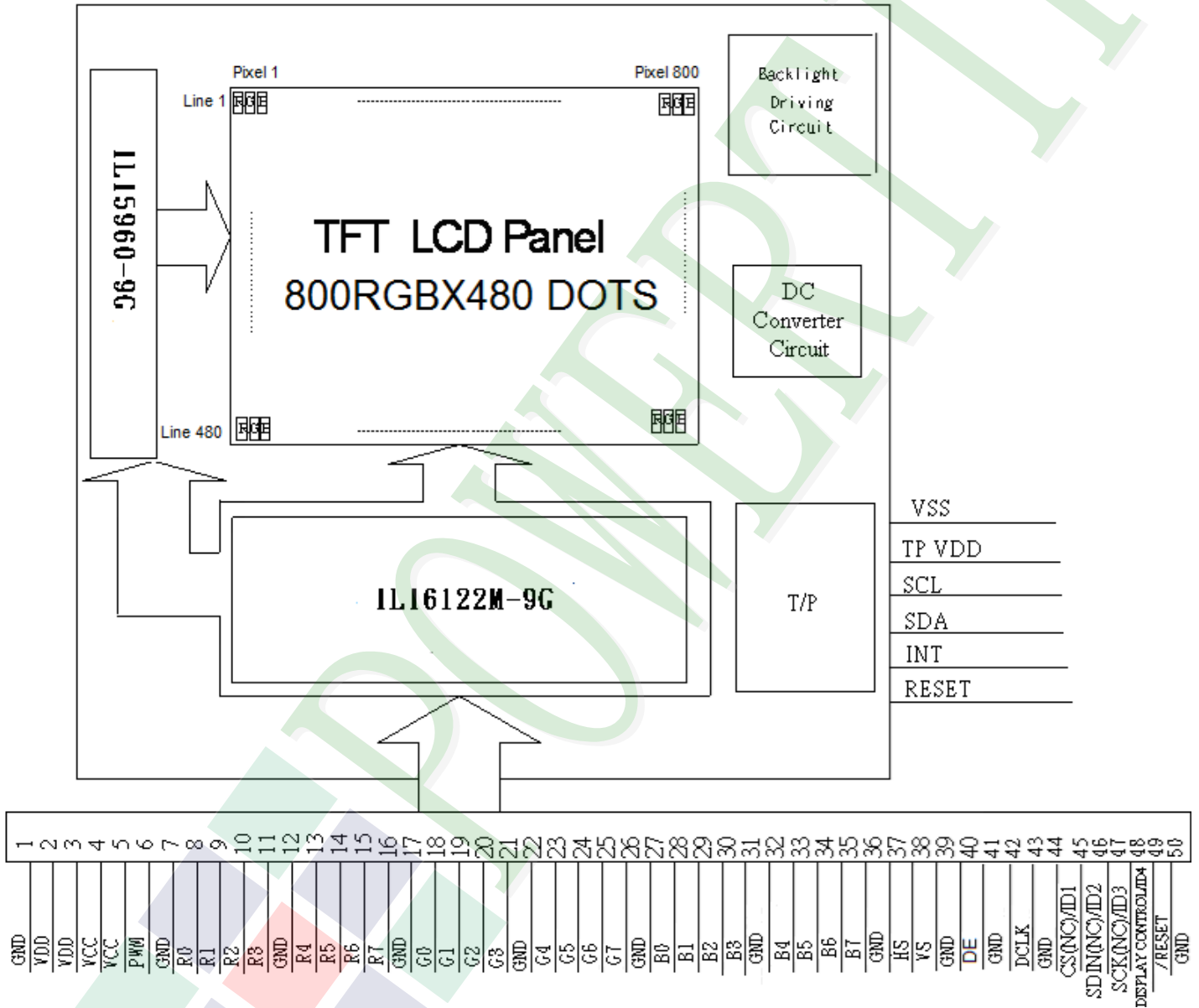

2.2 Interface Pin Description

Pin#	Name	DESCRIPTION
1	GND	Power ground.
2	VDD	Power for Digital Circuit.
3	VDD	Power for Digital Circuit.
4	VCC	Power For LED backlight.
5	VCC	Power For LED backlight.
6	PWM	Shutdown & Dimming control input for backlight. Do not allow this pin to float. "Hi" =100%, "Low" = 0%.
7	GND	Power ground.
8	R0	Red Data.
9	R1	Red Data.
10	R2	Red Data.
11	R3	Red Data.
12	GND	Power ground.
13	R4	Red Data.
14	R5	Red Data.
15	R6	Red Data.
16	R7	Red Data.
17	GND	Power ground.
18	G0	Green Data.
19	G1	Green Data.
20	G2	Green Data.
21	G3	Green Data.
22	GND	Power ground.
23	G4	Green Data.
24	G5	Green Data.
25	G6	Green Data.
26	G7	Green Data.
27	GND	Power ground.
28	B0	Blue Data.
29	B1	Blue Data.

Pin#	Name	DESCRIPTION
30	B2	Blue Data.
31	B3	Blue Data.
32	GND	Power ground.
33	B4	Blue Data.
34	B5	Blue Data.
35	B6	Blue Data.
36	B7	Blue Data.
37	GND	Power ground.
38	HS	Line synchronization signal. Horizontal Sync Input.
39	VS	Frame synchronization signal. Vertical Sync Input.
40	GND	Power ground.
41	DE	Display enable pin from controller. Data Input Enable.
42	GND	Power ground.
43	DCLK	Sample clock. Data will be latched at the falling edge of DCLK.
44	GND	Power ground.
45	CS(NC) / ID1	No Function./ ID[4:1]These pins select LCM type.
46	SDIN(NC) / ID2	No Function./ ID[4:1]These pins select LCM type.
47	SCK(NC) / ID3	No Function ./ ID[4:1]These pins select LCM type.
48	DISPLAY CONTROL /	Display Enable(Hi Active)./ ID[4:1]These pins select LCM type.
49	/RESET	Global Reset (Low Active).
50	GND	Power ground.

Capacitive Touch Panel(CTP) Interface

Pin No.	Symbol	Function
1	VSS	Touch Panel output pin.
2	TPVDD	Power Supply Voltage (3.3V)
3	SCL	I2C Clock
4	SDA	I2C Data
5	INT	The Interrupt the CTP to the Host
6	RESET	RESET

2.3 Timing Characteristics

2.3.1 Input Clock and Data Timing

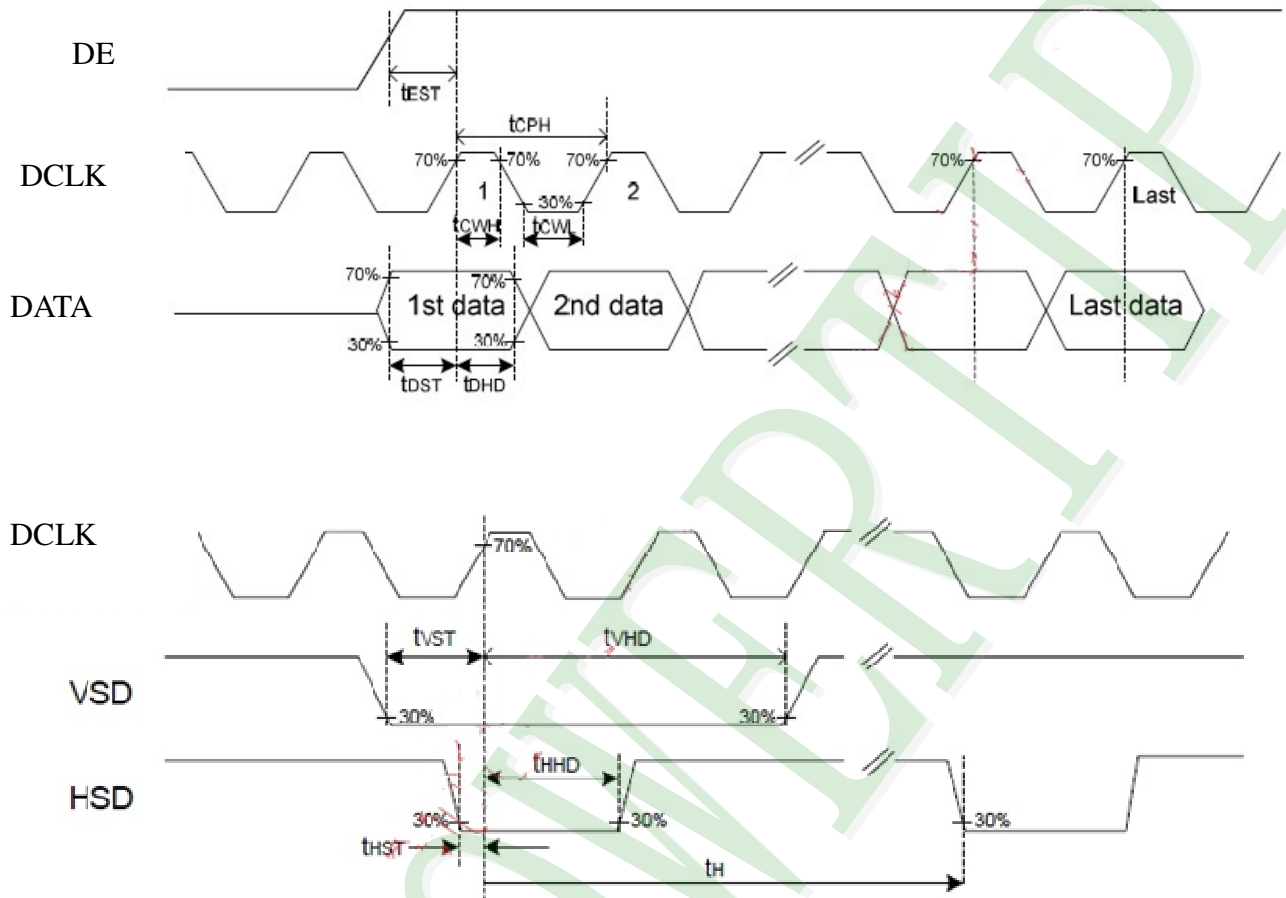

Parameters	Symbol	Spec			Unit	Conditions
		Min.	Typ.	Max.		
VDD Power ON slew rate	tPOR	--	--	20	ms	0V ~ 0.9VDD
RSTB pulse width	trST	10	--	--	us	CLKIN=50MHz
CLKIN cycle time	tCPH	20	--	--	ns	
CLKIN pulse duty	tcWH	40	50	60	%	
VSD setup time	tvST	8	--	--	ns	
VSD hold time	tvHD	8	--	--	ns	
HSD setup time	thST		--	--	ns	
HSD hold time	thHD	8	--	--	ns	
Data setup time	tdST	8	--	--	ns	D0[7:0], D1[7:0], D2[7:0] to CLKIN
Data hold time	tdHD	8	--	--	ns	D0[7:0], D1[7:0], D2[7:0] to CLKIN
DE setup time	teST	8	--	--	ns	
DE hold time	teHD	8	--	--	ns	
Output stable time	tsST	--	--	6	us	10% to 90% target voltage. CL=120pF, R=10KW
CLKIN frequency	fCLK	--	40	50	MHZ	VDD=3.0 ~ 3.6V
CLKIN cycle time	fCLK	20	25	--	ns	
CLKIN pulse duty	tcWH	40	50	60	%	TCLK
Time from HSD to Source output	thSO	--	20	--	CLKIN	
Time from HSD to LD	thLD	--	20	--	CLKIN	Note (2)
Time from HSD to STV	thSTV	--	2	--	CLKIN	
Time from HSD to CKV	thCKV		20	--	CLKIN	
Time from HSD to OEV	thOEV	--	4	--	CLKIN	
LD pulse width	twLD	--	10		CLKIN	Note (2)
CKV pulse width	twCKV	--	66	--	CLKIN	
OEV pulse width	twoEV	--	74	--	CLKIN	

Note: (1) VDD=3.0 ~ 3.6V, VDDA=6.5~13.5V, DGND=AGND=0V, Ta=-20~+85°C

(2) The contents of the data register are transferred to the latch circuit at the rising edge of LD. Then the gray scale voltage is output from the device at the falling edge of LD.

2.3.2 Vertical input timing

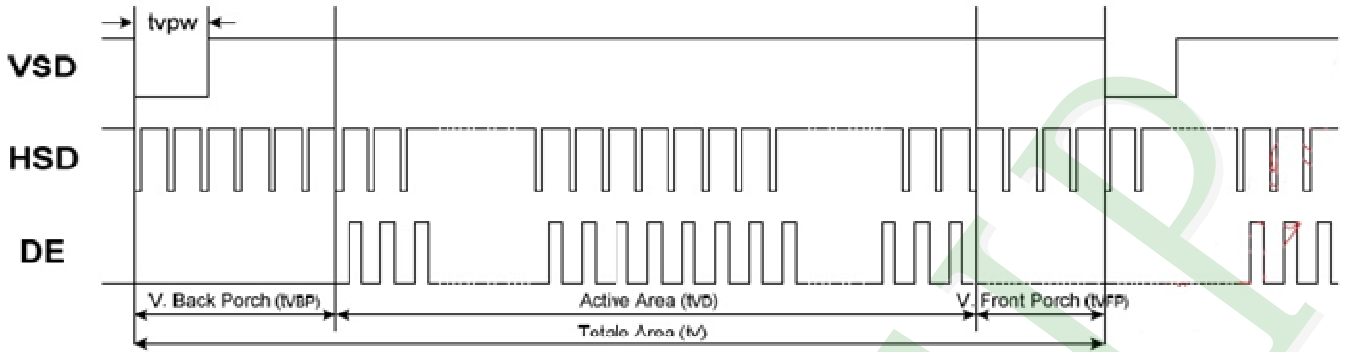

Parameter	Symbol	Value			Unit
		Min	Typ	Max	
Vertical display area	tvd		480		H
VSYNC period time	tv	510	525	650	H
VSYNC pulse width	tpw	1	-	20	H
VSYNC back Porch(Blanking)	tvb	23	23	23	H
VSYNC Front Porch	tvfb	7	22	147	H

2.3.3 Horizontal Input Timing

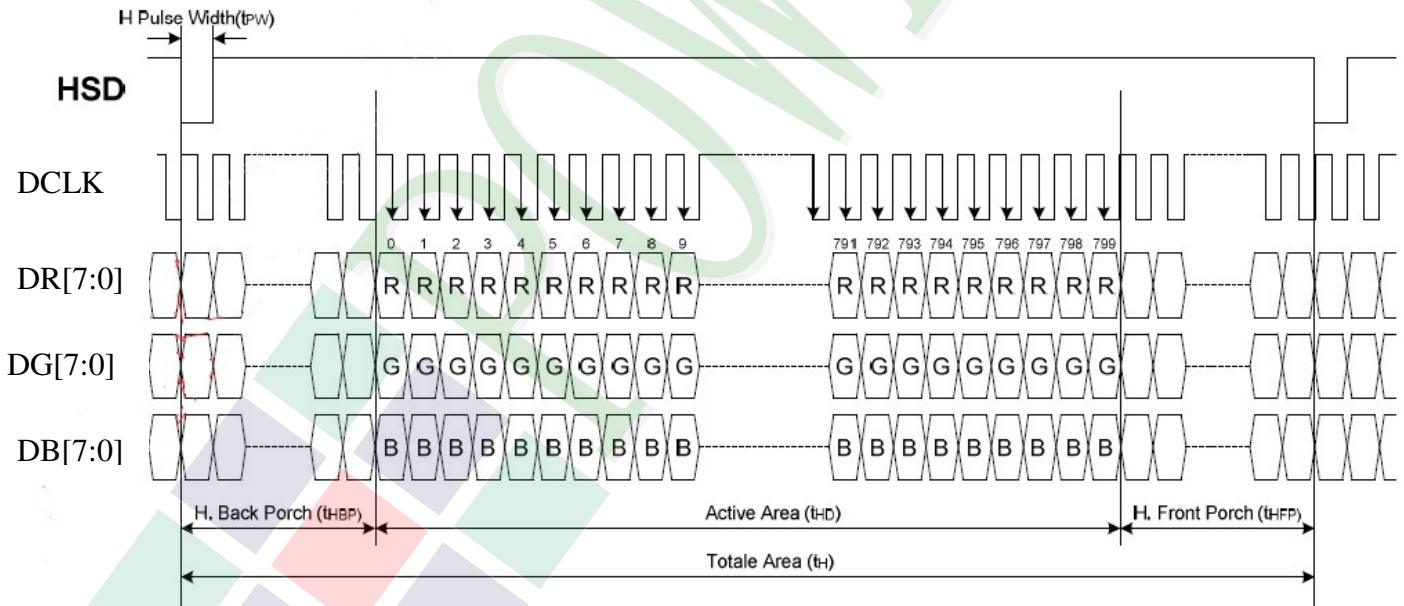

Parameter	Symbol	Value			Unit
		Min	Typ	Max	
Horizontal display area	thd	800			DCLK
DCLK frequency	fclk	-	33.3	50	MHz
1 Horizontal Line	th	862	1056	1200	DCLK
HSD pulse width	Min	-	1		
	Typ	-	-		
	Max	-	40		
HSD Back Porch (Blacking)	thp	46	46	46	
HSD Front Proch	thfb	16	210	354	

3. QUALITY ASSURANCE SYSTEM

3.1 Quality Assurance Flow Chart

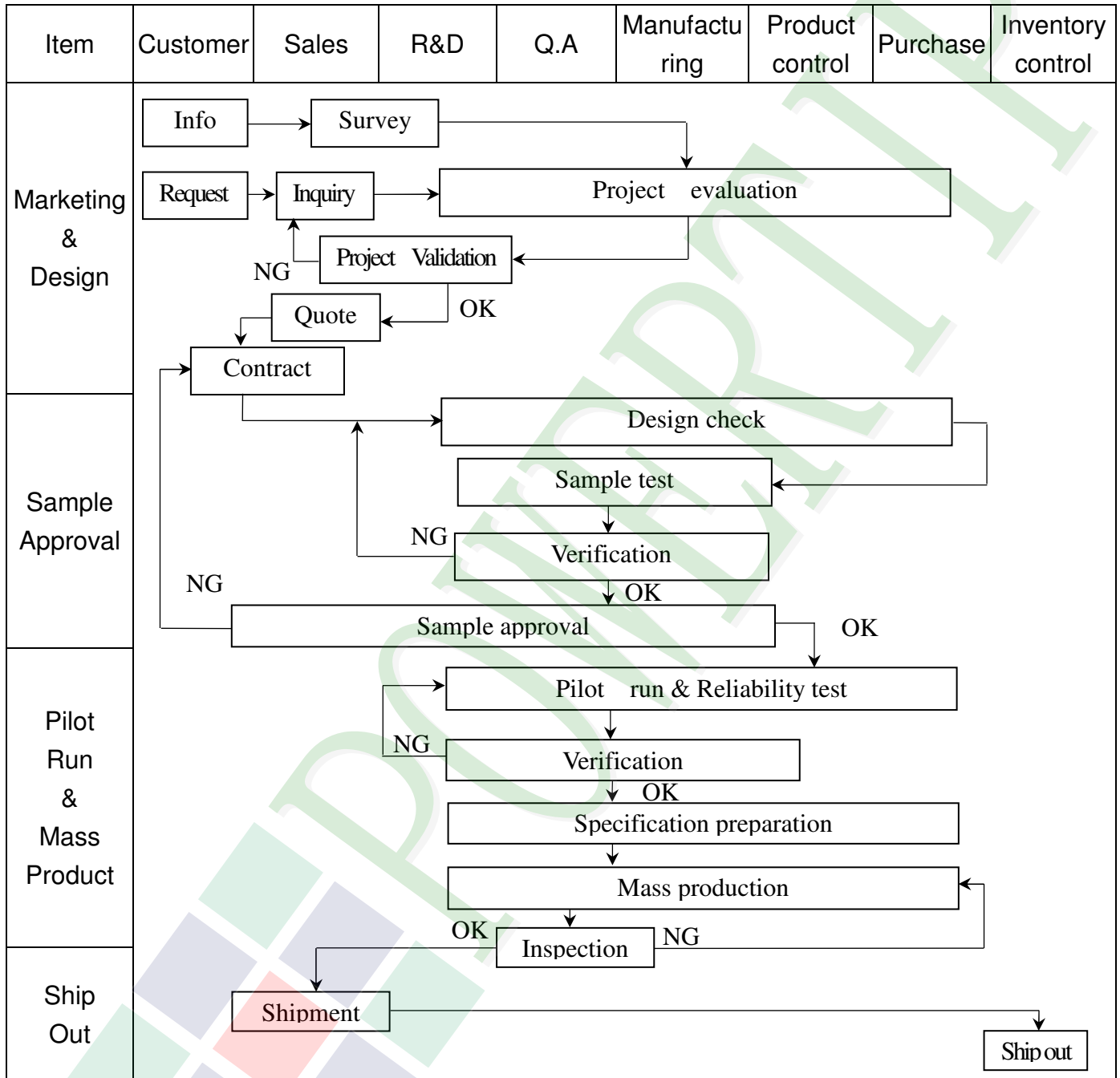

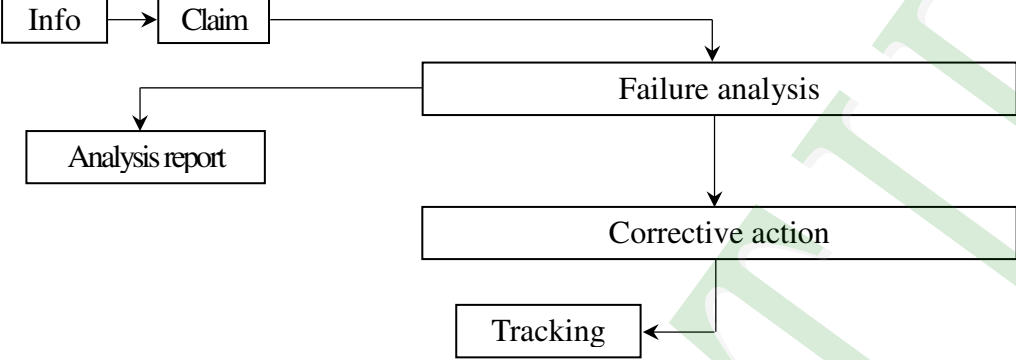
Item	Customer	Sales	R&D	Q.A	Manufacturing	Product control	Purchase	Inventory control
Sales Service	 <pre> graph TD Info[Info] --> Claim[Claim] Claim --> Failure[Failure analysis] Failure --> Report[Analysis report] Failure --> Action[Corrective action] Action --> Tracking[Tracking] </pre>							
Q.A Activity	1. ISO 9001 Maintenance Activities 3. Equipment calibration 5. Standardization Management				2. Process improvement proposal 4. Education And Training Activities			

3.2 Inspection Specification

◆Scope : The document shall be applied to TFT-LCD Module for 3.5" ~15" (Ver.B01).

◆Inspection Standard : MIL-STD-105E Table Normal Inspection Single Sampling Level II.

◆Equipment : Gauge 、 MIL-STD 、 Powertip Tester 、 Sample

◆Defect Level : Major Defect AQL : 0.4 ; Minor Defect AQL : 1.5

◆OUT Going Defect Level : Sampling.

◆Standard of the product appearance test :

a. Manner of appearance test :

(1). The test best be under 20W×2 fluorescent light , and distance of view must be at 30 cm.

(2). The test direction is base on about around 45° of vertical line.

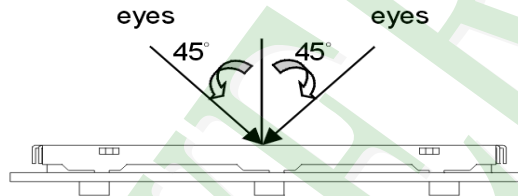

(3). Definition of area.

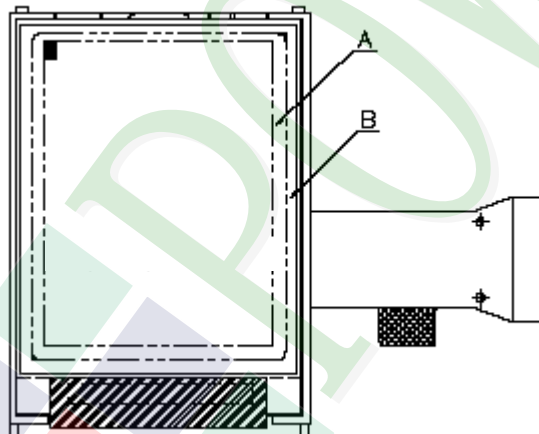

A area : viewing area

B area : Outside of viewing area

(4). Standard of inspection : (Unit : mm)

◆Specification For TFT-LCD Module 3.5" ~15" :
(Ver.B01)

NO	Item	Criterion	Level												
01	Product condition	1. 1 The part number is inconsistent with work order of production.	Major												
		1. 2 Mixed product types.	Major												
		1. 3 Assembled in inverse direction.	Major												
02	Quantity	2. 1 The quantity is inconsistent with work order of production.	Major												
03	Outline dimension	3. 1 Product dimension and structure must conform to structure diagram.	Major												
04	Electrical Testing	4. 1 Missing line character and icon.	Major												
		4. 2 No function or no display.	Major												
		4. 3 Display malfunction.	Major												
		4. 4 LCD viewing angle defect.	Major												
		4. 5 Current consumption exceeds product specifications.	Major												
		4. 6 Mura can not be seen through 5% ND filter. (Mura : Under the normal examination angle of view, the picture has the non-uniform phenomenon.)	Minor												
05	Dot defect (Bright dot 、 Dark dot) On -display	<table border="1" style="margin-left: auto; margin-right: auto;"> <thead> <tr> <th colspan="2">Item</th> <th>Acceptance (Q'ty)</th> </tr> </thead> <tbody> <tr> <td rowspan="4" style="text-align: center; vertical-align: middle;">Dot Defect</td> <td style="text-align: center;">Bright Dot</td> <td style="text-align: center;">≤ 4</td> </tr> <tr> <td style="text-align: center;">Dark Dot</td> <td style="text-align: center;">≤ 5</td> </tr> <tr> <td style="text-align: center;">Joint Dot</td> <td style="text-align: center;">≤ 3</td> </tr> <tr> <td style="text-align: center;">Total</td> <td style="text-align: center;">≤ 7</td> </tr> </tbody> </table>	Item		Acceptance (Q'ty)	Dot Defect	Bright Dot	≤ 4	Dark Dot	≤ 5	Joint Dot	≤ 3	Total	≤ 7	Minor
		Item		Acceptance (Q'ty)											
		Dot Defect	Bright Dot	≤ 4											
			Dark Dot	≤ 5											
			Joint Dot	≤ 3											
Total	≤ 7														
5. 1 Inspection pattern : full white , full black , Red , Green and blue screens.															
5. 2 It is defined as dot defect if defect area $> 1/2$ dot.															
5. 3 The distance between two dot defect ≥ 5 mm.															
5. 4 Bright dot that can not be seen through 5% ND filter.															

◆Specification For TFT-LCD Module 3.5" ~15" :

(Ver.B01)

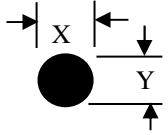
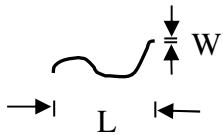
NO	Item	Criterion	Level																																										
06	Black or white dot、scratch、contamination Round type  $\Phi = (x + y) / 2$ Line type 	6.1 Round type (Non-display or display) : <table border="1"> <thead> <tr> <th rowspan="2">Dimension (diameter : Φ)</th> <th colspan="2">Acceptance (Q'ty)</th> </tr> <tr> <th>A area</th> <th>B area</th> </tr> </thead> <tbody> <tr> <td>$\Phi \leq 0.25$</td> <td colspan="2">Ignore</td> </tr> <tr> <td>$0.25 < \Phi \leq 0.50$</td> <td>5</td> <td rowspan="3">Ignore</td> </tr> <tr> <td>$\Phi > 0.50$</td> <td>0</td> </tr> <tr> <td>Total</td> <td>5</td> </tr> </tbody> </table>	Dimension (diameter : Φ)	Acceptance (Q'ty)		A area	B area	$\Phi \leq 0.25$	Ignore		$0.25 < \Phi \leq 0.50$	5	Ignore	$\Phi > 0.50$	0	Total	5	Minor																											
		Dimension (diameter : Φ)		Acceptance (Q'ty)																																									
A area	B area																																												
$\Phi \leq 0.25$	Ignore																																												
$0.25 < \Phi \leq 0.50$	5	Ignore																																											
$\Phi > 0.50$	0																																												
Total	5																																												
6.2 Line type(Non-display or display) : <table border="1"> <thead> <tr> <th rowspan="2">module size</th> <th rowspan="2">Length (L)</th> <th rowspan="2">Width (W)</th> <th colspan="2">Acceptance (Q'ty)</th> </tr> <tr> <th>A area</th> <th>B area</th> </tr> </thead> <tbody> <tr> <td rowspan="4">3.5" to less 9"</td> <td>---</td> <td>$W \leq 0.03$</td> <td colspan="2">Ignore</td> </tr> <tr> <td>$L \leq 10.0$</td> <td>$0.03 < W \leq 0.05$</td> <td>4</td> <td rowspan="4">Ignore</td> </tr> <tr> <td>$L \leq 5.0$</td> <td>$0.05 < W \leq 0.10$</td> <td>2</td> </tr> <tr> <td>---</td> <td>$W > 0.10$</td> <td colspan="2">As round type</td> </tr> <tr> <td colspan="3">Total</td> <td>5</td> </tr> <tr> <td rowspan="4">9" to 15"</td> <td>---</td> <td>$W \leq 0.05$</td> <td colspan="2">Ignore</td> </tr> <tr> <td>$L \leq 10.0$</td> <td>$0.05 < W \leq 0.10$</td> <td>5</td> <td rowspan="4">Ignore</td> </tr> <tr> <td>---</td> <td>$W > 0.10$</td> <td colspan="2">As round type</td> </tr> <tr> <td colspan="3">Total</td> <td>5</td> </tr> </tbody> </table>	module size	Length (L)	Width (W)	Acceptance (Q'ty)		A area	B area	3.5" to less 9"	---	$W \leq 0.03$	Ignore		$L \leq 10.0$	$0.03 < W \leq 0.05$	4	Ignore	$L \leq 5.0$	$0.05 < W \leq 0.10$	2	---	$W > 0.10$	As round type		Total			5	9" to 15"	---	$W \leq 0.05$	Ignore		$L \leq 10.0$	$0.05 < W \leq 0.10$	5	Ignore	---	$W > 0.10$	As round type		Total			5	
module size				Length (L)	Width (W)	Acceptance (Q'ty)																																							
	A area	B area																																											
3.5" to less 9"	---	$W \leq 0.03$	Ignore																																										
	$L \leq 10.0$	$0.03 < W \leq 0.05$	4	Ignore																																									
	$L \leq 5.0$	$0.05 < W \leq 0.10$	2																																										
	---	$W > 0.10$	As round type																																										
Total			5																																										
9" to 15"	---	$W \leq 0.05$	Ignore																																										
	$L \leq 10.0$	$0.05 < W \leq 0.10$	5	Ignore																																									
	---	$W > 0.10$	As round type																																										
	Total				5																																								
07	Polarizer Bubble	<table border="1"> <thead> <tr> <th rowspan="2">Dimension (diameter : Φ)</th> <th colspan="2">Acceptance (Q'ty)</th> </tr> <tr> <th>A area</th> <th>B area</th> </tr> </thead> <tbody> <tr> <td>$\Phi \leq 0.25$</td> <td colspan="2">Ignore</td> </tr> <tr> <td>$0.25 < \Phi \leq 0.50$</td> <td>4</td> <td rowspan="4">Ignore</td> </tr> <tr> <td>$0.50 < \Phi \leq 0.80$</td> <td>1</td> </tr> <tr> <td>$\Phi > 0.80$</td> <td>0</td> </tr> <tr> <td>Total</td> <td>5</td> </tr> </tbody> </table>	Dimension (diameter : Φ)		Acceptance (Q'ty)		A area	B area	$\Phi \leq 0.25$	Ignore		$0.25 < \Phi \leq 0.50$	4	Ignore	$0.50 < \Phi \leq 0.80$	1	$\Phi > 0.80$	0	Total	5	Minor																								
Dimension (diameter : Φ)	Acceptance (Q'ty)																																												
	A area	B area																																											
$\Phi \leq 0.25$	Ignore																																												
$0.25 < \Phi \leq 0.50$	4	Ignore																																											
$0.50 < \Phi \leq 0.80$	1																																												
$\Phi > 0.80$	0																																												
Total	5																																												

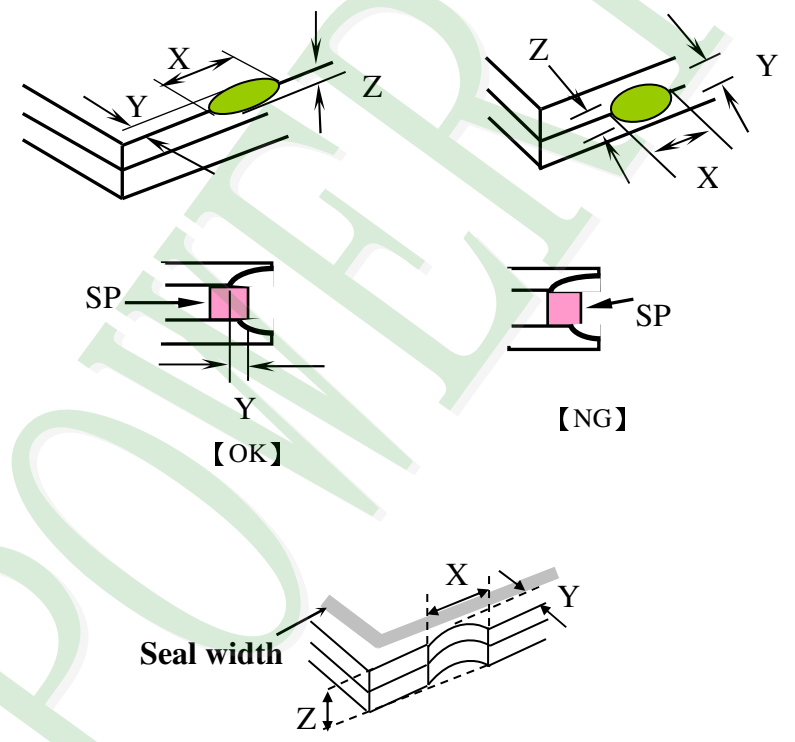
NO	Item	Criterion	Level						
08	The crack of glass	<p>Symbols :</p> <p>X : The length of crack Z : The thickness of crack t : The thickness of glass</p> <p>Y : The width of crack. W : terminal length a : LCD side length</p> <hr/> <p>8.1 General glass chip : 8.1.1 Chip on panel surface and crack between panels:</p> 	Minor						
		<table border="1" data-bbox="539 1579 1353 1870"> <thead> <tr> <th>X</th> <th>Y</th> <th>Z</th> </tr> </thead> <tbody> <tr> <td>$\leq a$</td> <td>Crack can't enter viewing area</td> <td>$\leq 1/2 t$</td> </tr> <tr> <td>$\leq a$</td> <td>Crack can't exceed the half of SP width.</td> <td>$1/2 t < Z \leq 2 t$</td> </tr> </tbody> </table>		X	Y	Z	$\leq a$	Crack can't enter viewing area	$\leq 1/2 t$
X	Y	Z							
$\leq a$	Crack can't enter viewing area	$\leq 1/2 t$							
$\leq a$	Crack can't exceed the half of SP width.	$1/2 t < Z \leq 2 t$							

◆ Specification For TFT-LCD Module 3.5" ~15" :

(Ver.B01)

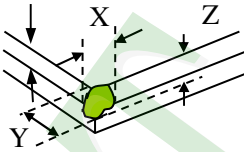
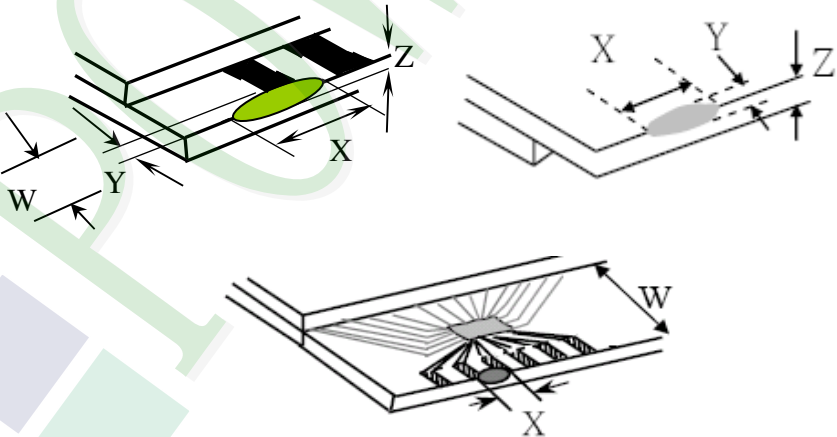
NO	Item	Criterion	Level												
08	The crack of glass	<p>Symbols :</p> <p>X : The length of crack Z : The thickness of crack t : The thickness of glass</p> <p>Y : The width of crack. W : terminal length a : LCD side length</p> <hr/> <p>8.1.2 Corner crack :</p>  <table border="1" data-bbox="523 768 1337 1059"> <thead> <tr> <th>X</th> <th>Y</th> <th>Z</th> </tr> </thead> <tbody> <tr> <td>$\leq 1/5 a$</td> <td>Crack can't enter viewing area</td> <td>$Z \leq 1/2 t$</td> </tr> <tr> <td>$\leq 1/5 a$</td> <td>Crack can't exceed the half of SP width.</td> <td>$1/2 t < Z \leq 2 t$</td> </tr> </tbody> </table>	X	Y	Z	$\leq 1/5 a$	Crack can't enter viewing area	$Z \leq 1/2 t$	$\leq 1/5 a$	Crack can't exceed the half of SP width.	$1/2 t < Z \leq 2 t$				
		X	Y	Z											
$\leq 1/5 a$	Crack can't enter viewing area	$Z \leq 1/2 t$													
$\leq 1/5 a$	Crack can't exceed the half of SP width.	$1/2 t < Z \leq 2 t$													
		<p>8.2 Protrusion over terminal :</p> <p>8.2.1 Chip on electrode pad :</p>  <table border="1" data-bbox="560 1697 1345 1872"> <thead> <tr> <th></th> <th>X</th> <th>Y</th> <th>Z</th> </tr> </thead> <tbody> <tr> <td>Front</td> <td>$\leq a$</td> <td>$\leq 1/2 W$</td> <td>$\leq t$</td> </tr> <tr> <td>Back</td> <td>$\leq a$</td> <td>$\leq W$</td> <td>$\leq 1/2 t$</td> </tr> </tbody> </table>		X	Y	Z	Front	$\leq a$	$\leq 1/2 W$	$\leq t$	Back	$\leq a$	$\leq W$	$\leq 1/2 t$	Minor
	X	Y	Z												
Front	$\leq a$	$\leq 1/2 W$	$\leq t$												
Back	$\leq a$	$\leq W$	$\leq 1/2 t$												

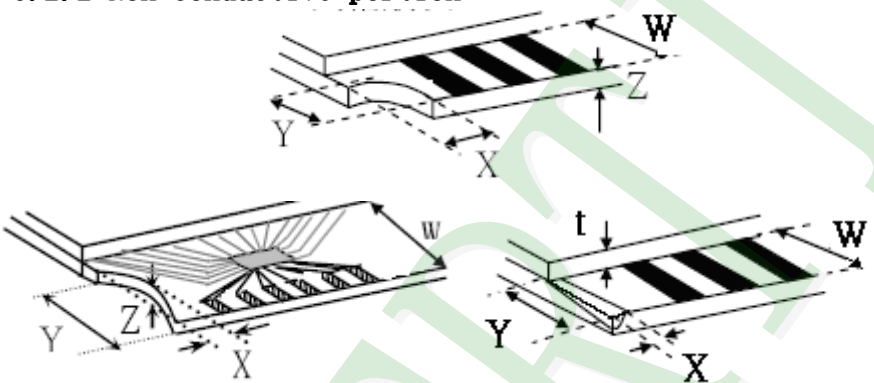
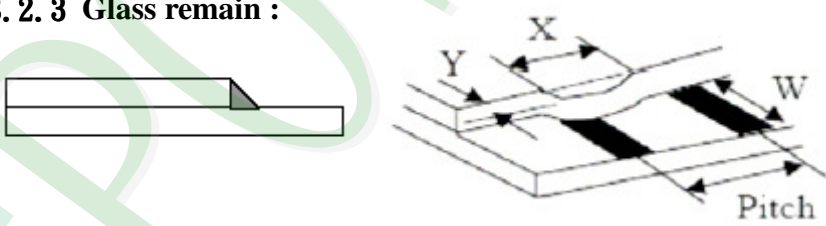
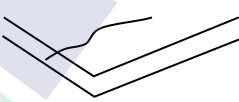
NO	Item	Criterion	Level									
08	The crack of glass	<p>Symbols :</p> <p>X : The length of crack Y : The width of crack. Z : The thickness of crack W : terminal length t : The thickness of glass a : LCD side length</p>	Minor									
		<p>8.2.2 Non-conductive portion :</p>  <table border="1" data-bbox="625 967 1257 1093"> <thead> <tr> <th>X</th> <th>Y</th> <th>Z</th> </tr> </thead> <tbody> <tr> <td>$\leq 1/3 a$</td> <td>$\leq W$</td> <td>$\leq t$</td> </tr> </tbody> </table> <p>⊙ If the chipped area touches the ITO terminal, over 2/3 of ● the ITO must remain and be inspected according to electrode terminal specifications.</p> <p>8.2.3 Glass remain :</p>  <table border="1" data-bbox="545 1523 1241 1648"> <thead> <tr> <th>X</th> <th>Y</th> <th>Z</th> </tr> </thead> <tbody> <tr> <td>$\leq a$</td> <td>$\leq 1/3 W$</td> <td>$\leq t$</td> </tr> </tbody> </table> <p>8.2.4 Cracking</p>  <p style="text-align: center;">Not Allowed</p>		X	Y	Z	$\leq 1/3 a$	$\leq W$	$\leq t$	X	Y	Z
X	Y	Z										
$\leq 1/3 a$	$\leq W$	$\leq t$										
X	Y	Z										
$\leq a$	$\leq 1/3 W$	$\leq t$										



◆Specification For TFT-LCD Module 3.5" ~15" :

(Ver.B01)

NO	Item	Criterion	Level
09	Backlight elements	9. 1 Backlight can't work normally.	Major
		9. 2 Backlight doesn't light or color is wrong.	Major
		9. 3 Illumination source flickers when lit.	Major
10	General appearance	10. 1 Pin type 、 quantity 、 dimension must match type in structure diagram.	Major
		10. 2 No short circuits in components on PCB or FPC .	Major
		10. 3 Parts on PCB or FPC must be the same as on the production characteristic chart .There should be no wrong parts , missing parts or excess parts.	Major
		10. 4 Product packaging must the same as specified on packaging specification sheet.	Minor
		10. 5 The folding and peeled off in polarizer are not acceptable.	Minor
		10. 6 The PCB or FPC between B/L assembled distance(PCB or FPC) is ≤ 1.5 mm.	Minor

5. PRECAUTION RELATING PRODUCT HANDLING

5.1 SAFETY

- 5.1.1 If the LCD panel breaks , be careful not to get the liquid crystal to touch your skin.
- 5.1.2 If the liquid crystal touches your skin or clothes , please wash it off immediately by using soap and water.

5.2 HANDLING

- 5.2.1 Avoid any strong mechanical shock which can break the glass.
- 5.2.2 Avoid static electricity which can damage the CMOS LSI—When working with the module , be sure to ground your body and any electrical equipment you may be using.
- 5.2.3 Do not remove the panel or frame from the module.
- 5.2.4 The polarizing plate of the display is very fragile. So , please handle it very carefully ,do not touch , push or rub the exposed polarizing with anything harder than an HB pencil lead (glass , tweezers , etc.)
- 5.2.5 Do not wipe the polarizing plate with a dry cloth , as it may easily scratch the surface of plate.
- 5.2.6 Do not touch the display area with bare hands , this will stain the display area.
- 5.2.7 Do not use ketonics solvent & aromatic solvent. Use with a soft cloth soaked with a cleaning naphtha solvent.
- 5.2.8 To control temperature and time of soldering is $320\pm 10^{\circ}\text{C}$ and 3-5 sec.
- 5.2.9 To avoid liquid (include organic solvent) stained on LCM .

5.3 STORAGE

- 5.3.1 Store the panel or module in a dark place where the temperature is $25^{\circ}\text{C} \pm 5^{\circ}\text{C}$ and the humidity is below 65% RH.
- 5.3.2 Do not place the module near organics solvents or corrosive gases.
- 5.3.3 Do not crush , shake , or jolt the module.

5.4 TERMS OF WARRANTY

5.4.1 Applicable warrant period

The period is within thirteen months since the date of shipping out under normal using and storage conditions.

5.4.2 Unaccepted responsibility

This product has been manufactured to your company's specification as a part for use in your company's general electronic products. It is guaranteed to perform according to delivery specifications. For any other use apart from general electronic equipment , we cannot take responsibility if the product is used in nuclear power control equipment , aerospace equipment , fire and security systems or any other applications in which there is a direct risk to human life and where extremely high levels of reliability are required.

Approve	Check	Contact
Jimmy Chen	Tina Chen	Annie Kang

1. 包裝材料規格表 (Packaging Material) : (per carton)

No.	Item	Model	Dimensions (mm)	1Pcs Weight	Quantity	Total Weight
1	成品 (LCM)	PH800480T024-IHC07	131.0 X 90.5	0.0947	144	13.6368
2	多層薄膜(1)POF	OTFILM0BA03ABA	19"X350X0.015	—	6	—
3	TRAY 盤 (2)Tray	TY00000000308	352 X 260 X 12.8	0.0965	42	4.053
4	舒美墊(3) EPE	FOAM000000047	350 X 255 X 5	0.011	6	0.066
5	內盒(4)Product Box	BX36627063ABBA	383 X 270 X 66	0.182	6	1.092
6	保利龍板(5)Polylon board	OTPLB00PL08ABA	550 X 393 X 20	0.0284	2	0.0568
7	外紙箱(6)Carton	BX57041027CCBA	570 X 410 X 265	1.0	1	1.0
8						
9						

2. 一整箱總重量 (Total LCD Weight in carton) : 19.90 Kg±10%

3. 單箱數量規格表 (Packaging Specifications and Quantity) :

(1) LCM quantity per box : no per tray	4	x no of tray	6	=	24
(2) Total LCM quantity in carton : quantity per box	24	x no of boxes	6	=	144

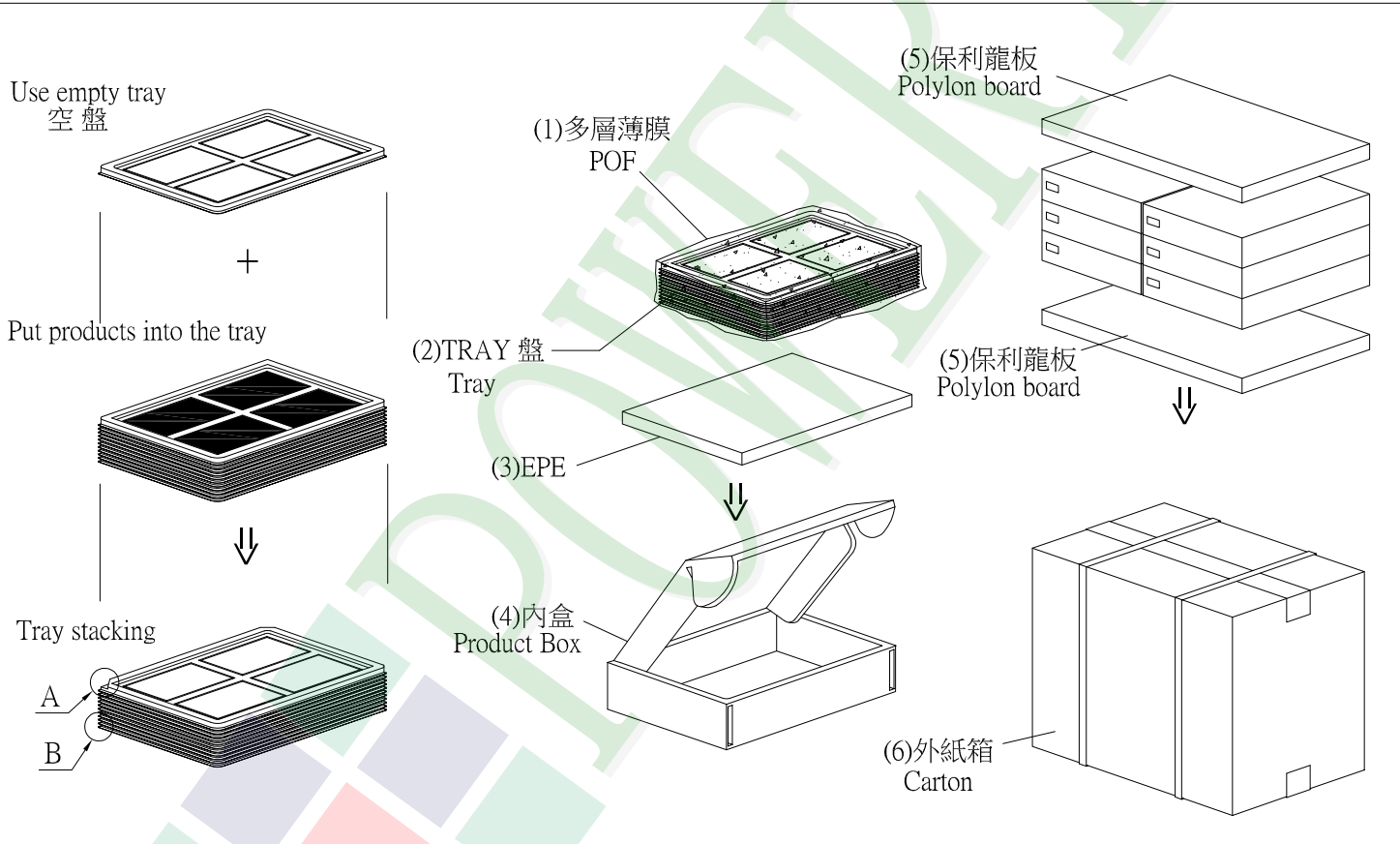

特 記 事 項 (REMARK)

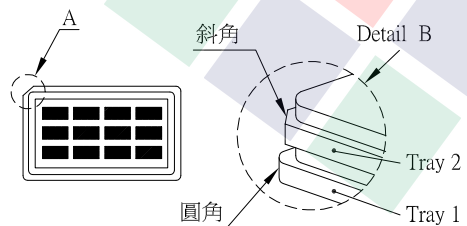

4. TRAY盤相疊時,需旋轉180度,請詳見B視圖
 Rotate tray 180 degrees and place on top of stack.
 Check the tray stack using Fig. B.