

ITEM NO.	PART NUMBER	DESCRIPTION	QTY.	COMPONENT NOTES
1	50-00026	Connector, dc plug, 5.5x2.5xL23 mm, molding style, spring contacts	1	
2	30-00683	Wire, 2C TS, 18 AWG, UL2464, 300V, 80C, 5.2 mm, VW-1, PVC	1	
3	24-00182	Overmold, dc plug, 5.5 mm, Tensility	1	PVC, black

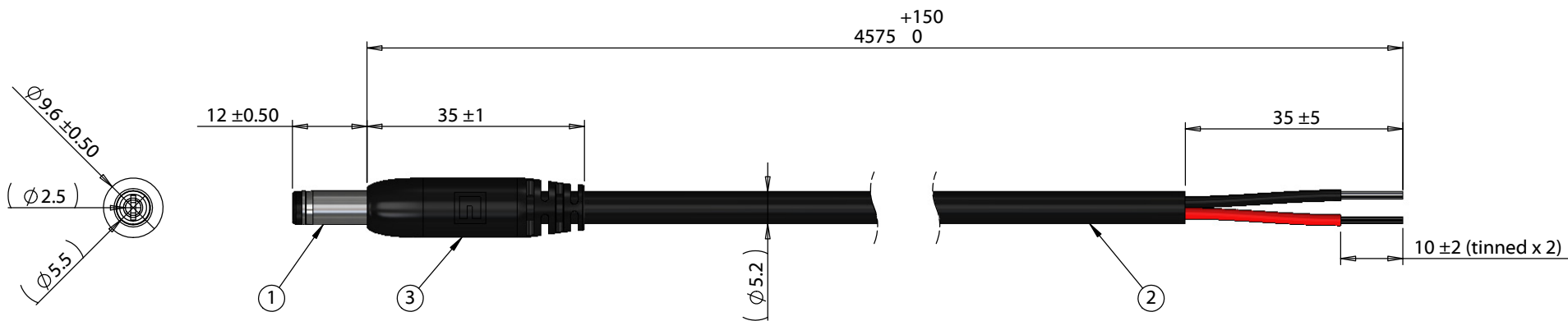

Notes:
Functionally equivalent components may be substituted

Wiring Diagram	
50-00026	wire color
center	red
sleeve	black

Revision:	Date:	Description:	Prepared:	Notes: RoHS compliant Function test: no open, no short circuit, no intermittent	<h1>TENSILITY</h1> <p>tel 1.541.323.3228 800 877.670.7118 fax 1.541.323.4202 web tensility.com</p>
A	06/06/2019	Initial release	Verified:		
			Dimensions are in millimeters. Tolerances: X: ± 0.5 mm X.X: ± 0.3 mm X.XX: ± 0.05 mm	Description:	Size: Part number:
				Cable, 4575 mm, 5.5x2.5x12 mm 50-00026 dc plug to stripped tinned, 18 AWG, 30-00683 wire	A 10-03349
				Scale: 1:1	Sheet 1 of 1

5

4

3

2

1