

5 CKT WITHOUT
MOUNTING EARS SHOWN

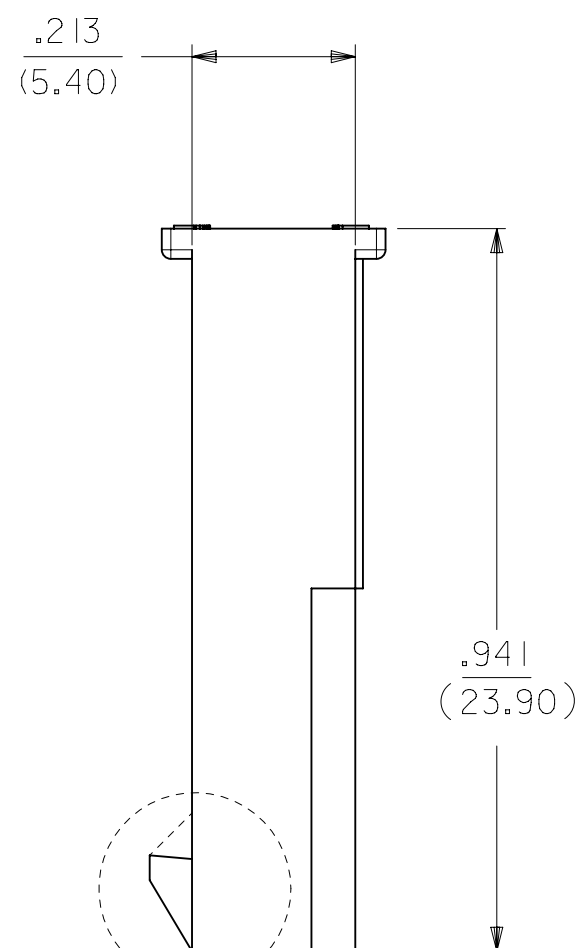

LOCK OPTION:

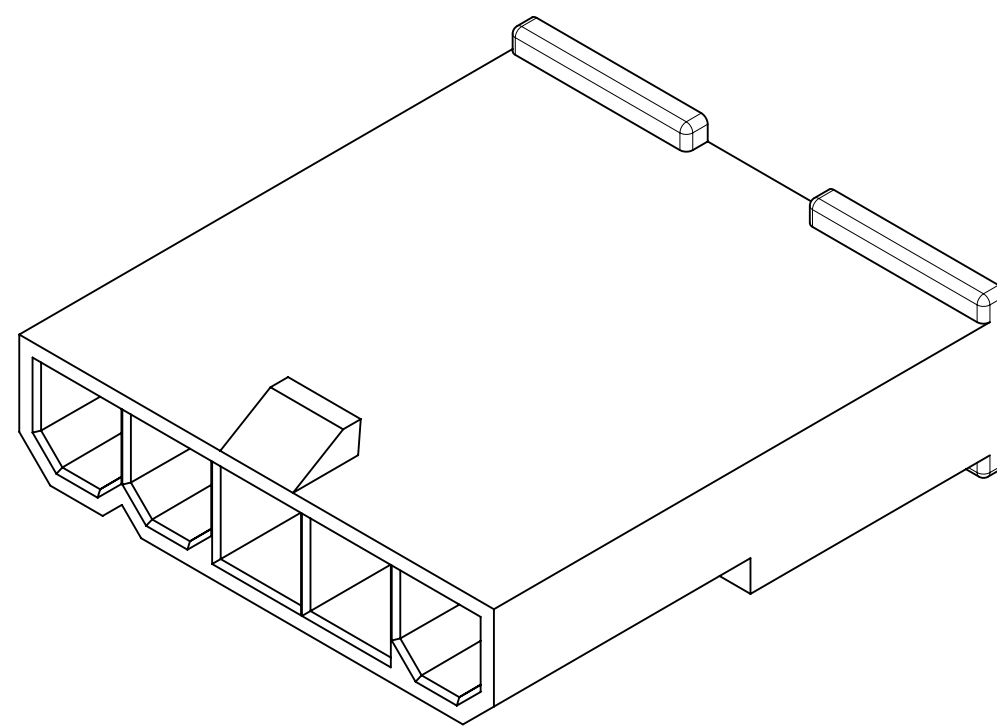
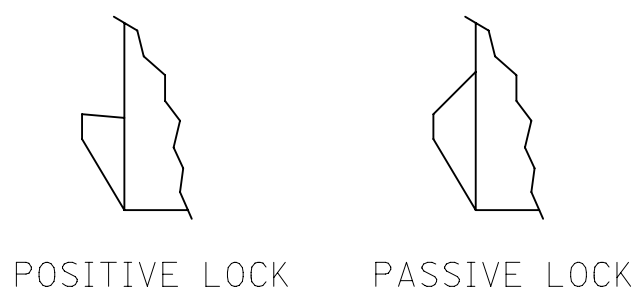

CKT SIZE	DIM A	DIM B	DIM C	DIM D
2	.165 (4.20)	.378 (9.60)	.394 (10.00)	.591 (15.00)
4	.496 (12.60)	.709 (18.00)	.724 (18.40)	.921 (23.40)
5	.661 (16.80)	.874 (22.20)	.890 (22.60)	1.087 (27.60)
6	.827 (21.00)	1.039 (26.40)	1.055 (26.80)	1.252 (31.80)
7	.992 (25.20)	1.205 (30.60)	1.220 (31.00)	1.417 (36.00)
8	1.157 (29.40)	1.370 (34.80)	1.386 (35.20)	1.583 (40.20)
9	1.323 (33.60)	1.535 (39.00)	1.551 (39.40)	1.748 (44.40)
10	1.488 (37.80)	1.701 (43.20)	1.717 (43.60)	1.913 (48.60)
11	1.654 (42.00)	1.866 (47.40)	1.882 (47.80)	2.079 (52.80)
12	1.819 (46.20)	2.031 (51.60)	2.047 (52.00)	2.244 (57.00)

NOTES:

- MATERIAL: BLANK=NYLON 6/6, UL 94V-2, COLOR: NATURAL.
210=NYLON 6/6, UL 94V-0, COLOR: NATURAL.
400=NYLON 6/6, UL 94 V-0, COLOR: BLACK.
- FINISH: NOTE APPLICABLE
- PRODUCT SPECIFICATION: PS-5556-001
- PACKAGING SPECIFICATION: BULK PER PK-5559-003
- THIS PART MATES WITH RECEPTACLE NO. 5557.
- THIS PART IS FOR USE WITH MOLEX MALE TERMINAL NO. 5558-*
- PANEL MOUNT VERSION IS FOR USE WITH .031/.079/(0.80/2.00) THICK PANELS.
- PANEL SHOULD BE PUNCHED IN THE DIRECTION OF CONNECTOR INSERTION.
- FACTORY ID MAY BE LOCATED ON EARS.
- THIS PART CONFORMS TO CLASS B REQUIREMENTS OF COSMETIC SPECIFICATION PS-45499-002.
- PART IS NOT DESIGNED FOR CURRENT SHARING.
- PARTS ARE NOT TO BE MATED OR UNMATED WHILE CIRCUITS ARE LIVE.
- WIRES ARE TO BE DRESSED IN SUCH A MANNER TO ALLOW THE TERMINALS TO FLOAT FREELY IN THE POCKET.

THIS DRAWING CONTAINS INFORMATION THAT IS PROPRIETARY TO MOLEX ELECTRONIC TECHNOLOGIES, LLC AND SHOULD NOT BE USED WITHOUT WRITTEN PERMISSION											
DIMENSION UNITS IN/MM		SCALE 1:1		CURRENT REV DESC: REMOVED OBSOLETE PART NUMBER AS PER PCN#511918				molex		MINI-FIT JR. SERIES PLUG (SINGLE ROW)	
GENERAL TOLERANCES (UNLESS SPECIFIED)				EC NO: 703993 DRWN: SUGEEB CHK'D: GGA APPR: GGA							
4 PLACES ±		±		2022/04/07				PRODUCT CUSTOMER DRAWING			
3 PLACES ±		± 0.01		2022/04/25				DOCUMENT NUMBER		DOC TYPE DOC PART REVISION	
2 PLACES ± 0.25		± 0.015		2022/04/25				55590002-SD		PSD 000 A1	
1 PLACE ± 0.38		±		INITIAL REVISION:				MATERIAL NUMBER CUSTOMER SHEET NUMBER			
0 PLACES ±		±		1989/02/19 2011/03/10				SEE TABLE		GENERAL MARKET 1 OF 3	
ANGULAR TOL ± 0.5 °				THIRD ANGLE PROJECTION		DRAWING		SERIES			
DRAFT WHERE APPLICABLE MUST REMAIN WITHIN DIMENSIONS				C-SIZE		5559					

THIS DRAWING REPLACES DRAWING SD-5559-NLP+

DOCUMENT STATUS	P1	RELEASE DATE	2022/04/25	07:01:54
-----------------	----	--------------	------------	----------

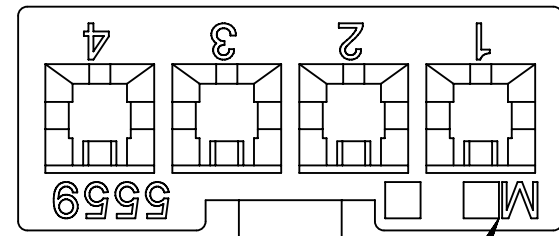

FACTORY ID
SEE NOTE 9

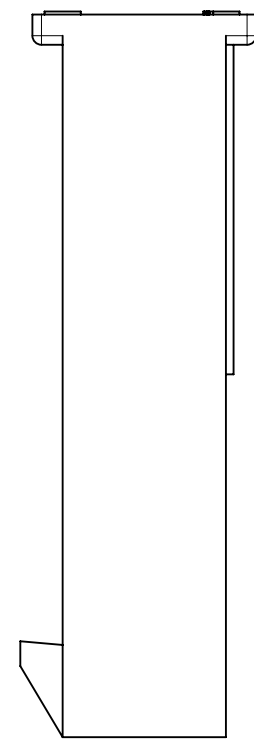
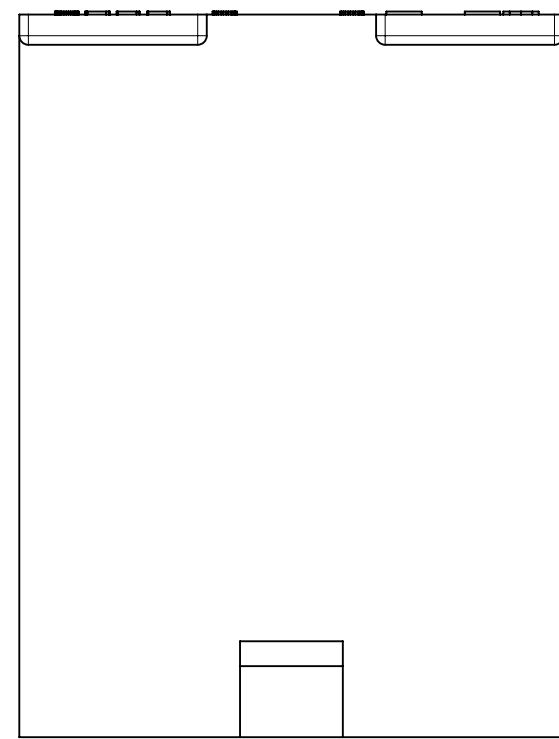

SEE NOTE 9

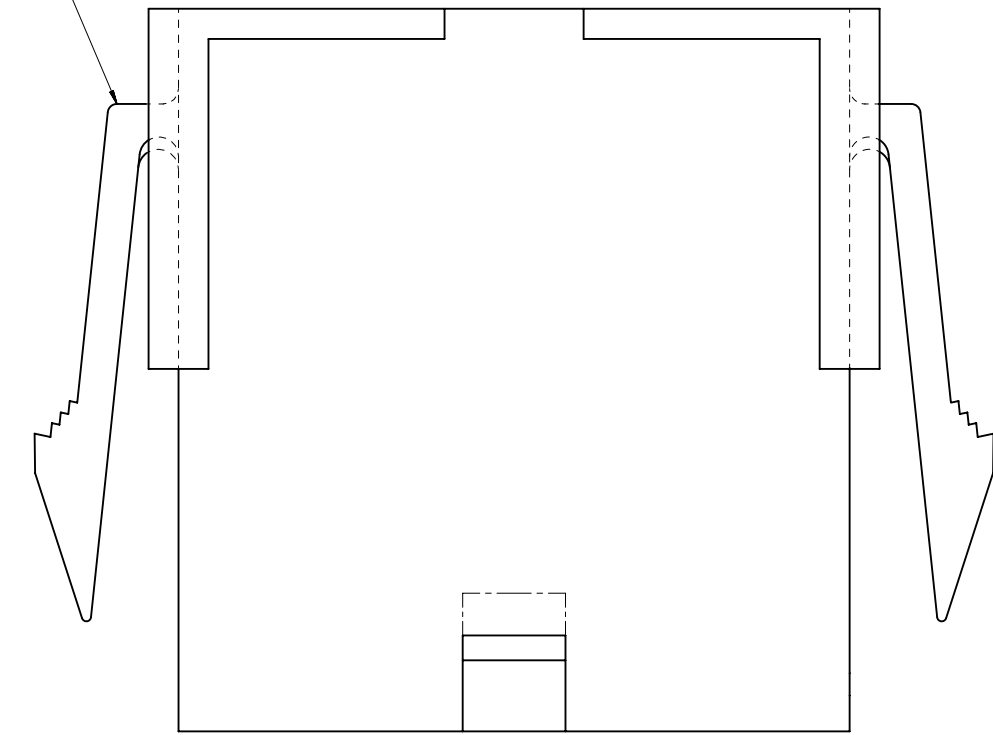

WITH MOUNTING EARS

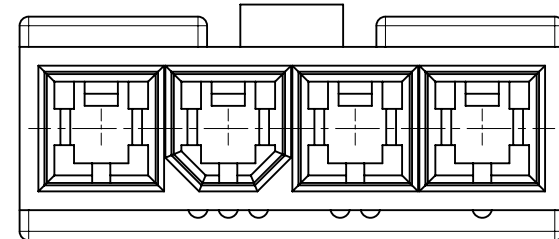
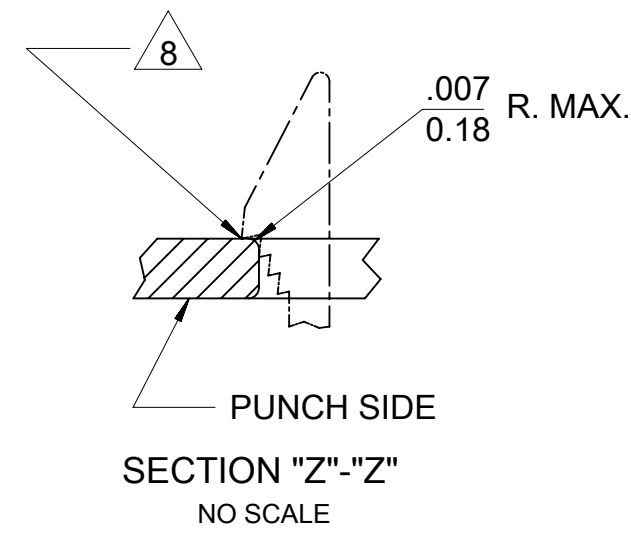

4 CKT WITHOUT
MOUNTING EARS SHOWN

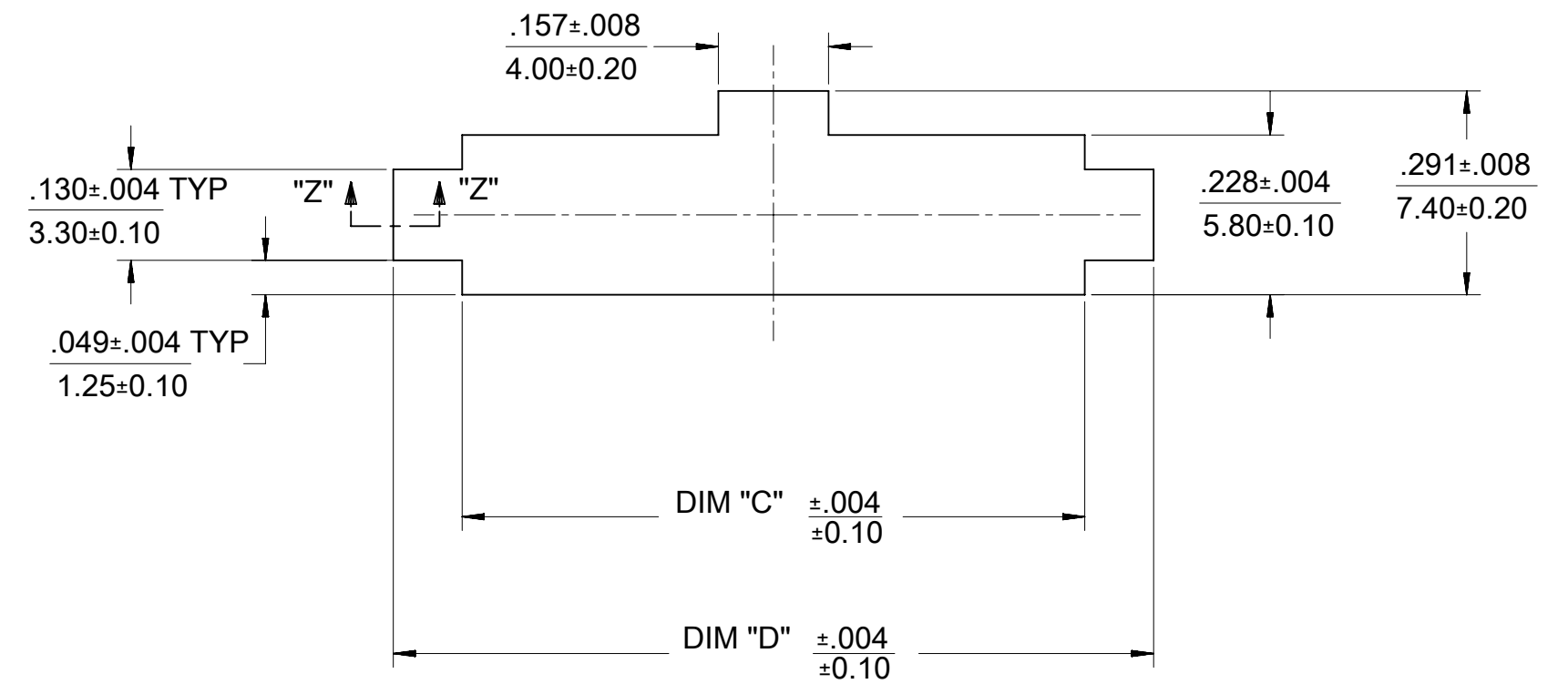

RECOMMENDED PANEL CUT-OUT
(SEE NOTE 7 & 8)

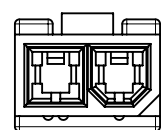

2 CIRCUIT

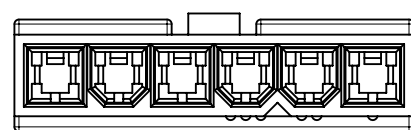

6 CIRCUIT

POLARIZATION

THIS DRAWING CONTAINS INFORMATION THAT IS PROPRIETARY TO MOLEX ELECTRONIC TECHNOLOGIES, LLC AND SHOULD NOT BE USED WITHOUT WRITTEN PERMISSION									
DIMENSION UNITS IN/MM		SCALE 1:1		CURRENT REV DESC: REMOVED OBSOLETE PART NUMBER AS PER PCN#511918				molex	
GENERAL TOLERANCES (UNLESS SPECIFIED)				EC NO: 703993		2022/04/07			
4 PLACES		±	±	DRWN: SUGEEB		2022/04/25		MINI-FIT JR. SERIES PLUG (SINGLE ROW)	
3 PLACES		±	± 0.01	CHK'D: GGA		2022/04/25			
2 PLACES		± 0.25	± 0.015	APPR: GGA		2022/04/25		PRODUCT CUSTOMER DRAWING	
1 PLACE		± 0.38	±	INITIAL REVISION:					
0 PLACES		±	±	DRWN: KSS		1989/02/19		DOCUMENT NUMBER	
ANGULAR TOL		± 0.5 °		APPR: FSMITH		2011/03/10		55590002-SD	
DRAFT WHERE APPLICABLE MUST REMAIN WITHIN DIMENSIONS		THIRD ANGLE PROJECTION		DRAWING		SERIES		MATERIAL NUMBER	
				C-SIZE		5559		SEE TABLE	
								CUSTOMER	
								GENERAL MARKET	
								DOC TYPE	
								PSD	
								DOC PART	
								000	
								REVISION	
								A1	
								SHEET NUMBER	
								2 OF 3	

THIS DRAWING REPLACES DRAWING SD-5559-NLP+

DOCUMENT STATUS	P1	RELEASE DATE	2022/04/25	07:01:54
-----------------	----	--------------	------------	----------

TOOLED	PART NO	ENG NO	CKT SIZE	MOUNTING OPTION	LOCK OPTION	MATERIAL SEE NOTE I
YES	46999-0655	5559-02P2	2	W/EARS	POSITIVE	94V-2
YES	46999-0656	5559-02P3	2	W/O EAR	POSITIVE	94V-2
YES	46999-0657	5559-02P2-2 I0	2	W/EARS	POSITIVE	94V-0
YES	46999-0658	5559-02P3-2 I0	2	W/O EAR	POSITIVE	94V-0
YES	46999-0884	5559-02P2-400	2	WEARS	POSITIVE	94V-0 BLACK
YES	46999-0885	5559-02P3-400	2	W/O EAR	POSITIVE	94V-0 BLACK
YES	39-01-4046	5559-04P3	4	W/O EAR	POSITIVE	94V-2
YES	39-01-4043	5559-04P2-2 I0	4	W/EARS	POSITIVE	94V-0
YES	39-01-4047	5559-04P3-2 I0	4	W/O EAR	POSITIVE	94V-0
YES	46999-0561	5559-04P3-400	4	W/O EAR	POSITIVE	94V-0 BLACK
YES	39-01-4052	5559-05P2	5	W/EARS	POSITIVE	94V-2
YES	39-01-4056	5559-05P3	5	W/O EAR	POSITIVE	94V-2
YES	39-01-4053	5559-05P2-2 I0	5	W/EARS	POSITIVE	94V-0
YES	39-01-4057	5559-05P3-2 I0	5	W/O EAR	POSITIVE	94V-0
YES	50-30-4446	5559-05P3-400	5	W/O EAR	POSITIVE	94V-0 BLACK
YES	39-01-4062	5559-06P2	6	W/EARS	POSITIVE	94V-2
YES	39-01-4066	5559-06P3	6	W/O EAR	POSITIVE	94V-2
YES	46999-0886	5559-06P2-400	6	WEARS	POSITIVE	94V-0 BLACK
YES	46999-0887	5559-06P3-400	6	W/O EAR	POSITIVE	94V-0 BLACK
YES	39-01-4063	5559-06P2-2 I0	6	W/EARS	POSITIVE	94V-0
YES	39-01-4067	5559-06P3-2 I0	6	W/O EAR	POSITIVE	94V-0
NO	39-01-4072	5559-07P2	7	W/EARS	POSITIVE	94V-2
NO	39-01-4076	5559-07P3	7	W/O EAR	POSITIVE	94V-2
NO	39-01-4073	5559-07P2-2 I0	7	W/EARS	POSITIVE	94V-0
NO	39-01-4077	5559-07P3-2 I0	7	W/O EAR	POSITIVE	94V-0
NO	39-01-4082	5559-08P2	8	W/EARS	POSITIVE	94V-2
NO	39-01-4086	5559-08P3	8	W/O EAR	POSITIVE	94V-2
NO	39-01-4083	5559-08P2-2 I0	8	W/EARS	POSITIVE	94V-0
NO	39-01-4087	5559-08P3-2 I0	8	W/O EAR	POSITIVE	94V-0
NO	39-01-4092	5559-09P2	9	W/EARS	POSITIVE	94V-2
NO	39-01-4096	5559-09P3	9	W/O EAR	POSITIVE	94V-2
NO	39-01-4093	5559-09P2-2 I0	9	W/EARS	POSITIVE	94V-0
NO	39-01-4097	5559-09P3-2 I0	9	W/O EAR	POSITIVE	94V-0
NO	39-01-4102	5559-10P2	10	W/EARS	POSITIVE	94V-2
NO	39-01-4106	5559-10P3	10	W/O EAR	POSITIVE	94V-2
NO	39-01-4103	5559-10P2-2 I0	10	W/EARS	POSITIVE	94V-0
NO	39-01-4107	5559-10P3-2 I0	10	W/O EAR	POSITIVE	94V-0
NO	39-01-4112	5559-11P2	11	W/EARS	POSITIVE	94V-2
NO	39-01-4116	5559-11P3	11	W/O EAR	POSITIVE	94V-2
NO	39-01-4113	5559-11P2-2 I0	11	W/EARS	POSITIVE	94V-0
NO	39-01-4117	5559-11P3-2 I0	11	W/O EAR	POSITIVE	94V-0
NO	39-01-4122	5559-12P2	12	W/EARS	POSITIVE	94V-2
NO	39-01-4126	5559-12P3	12	W/O EAR	POSITIVE	94V-2
NO	39-01-4123	5559-12P2-2 I0	12	W/EARS	POSITIVE	94V-0
NO	39-01-4127	5559-12P3-2 I0	12	W/O EAR	POSITIVE	94V-0

TOOLED	PART NO	ENG NO	CKT SIZE	MOUNTING OPTION	LOCK OPTION	MATERIAL SEE NOTE I
NO	NO E.D.P.	5559-04P4	4	W/EARS	PASSIVE	94V-2
NO	NO E.D.P.	5559-04P5	4	W/O EAR	PASSIVE	94V-2
NO	NO E.D.P.	5559-04P4-2 I0	4	W/EARS	PASSIVE	94V-0
NO	NO E.D.P.	5559-04P5-2 I0	4	W/O EAR	PASSIVE	94V-0
NO	NO E.D.P.	5559-05P5-2 I0	5	W/O EAR	PASSIVE	94V-0
NO	NO E.D.P.	5559-05P5-400	5	W/O EAR	PASSIVE	94V-0 BLACK
NO	NO E.D.P.	5559-06P4	6	W/EARS	PASSIVE	94V-2
NO	NO E.D.P.	5559-06P5	6	W/O EAR	PASSIVE	94V-2
NO	NO E.D.P.	5559-06P4-2 I0	6	W/EARS	PASSIVE	94V-0
NO	NO E.D.P.	5559-06P5-2 I0	6	W/O EAR	PASSIVE	94V-0
NO	NO E.D.P.	5559-07P4	7	W/EARS	PASSIVE	94V-2
NO	NO E.D.P.	5559-07P5	7	W/O EAR	PASSIVE	94V-2
NO	NO E.D.P.	5559-07P4-2 I0	7	W/EARS	PASSIVE	94V-0
NO	NO E.D.P.	5559-07P5-2 I0	7	W/O EAR	PASSIVE	94V-0
NO	NO E.D.P.	5559-08P4	8	W/EARS	PASSIVE	94V-2
NO	NO E.D.P.	5559-08P5	8	W/O EAR	PASSIVE	94V-2
NO	NO E.D.P.	5559-08P4-2 I0	8	W/EARS	PASSIVE	94V-0
NO	NO E.D.P.	5559-08P5-2 I0	8	W/O EAR	PASSIVE	94V-0
NO	NO E.D.P.	5559-09P4	9	W/EARS	PASSIVE	94V-2
NO	NO E.D.P.	5559-09P5	9	W/O EAR	PASSIVE	94V-2
NO	NO E.D.P.	5559-09P4-2 I0	9	W/EARS	PASSIVE	94V-0
NO	NO E.D.P.	5559-09P5-2 I0	9	W/O EAR	PASSIVE	94V-0
NO	NO E.D.P.	5559-10P4	10	W/EARS	PASSIVE	94V-2
NO	NO E.D.P.	5559-10P5	10	W/O EAR	PASSIVE	94V-2
NO	NO E.D.P.	5559-10P4-2 I0	10	W/EARS	PASSIVE	94V-0
NO	NO E.D.P.	5559-10P5-2 I0	10	W/O EAR	PASSIVE	94V-0
NO	NO E.D.P.	5559-11P4	11	W/EARS	PASSIVE	94V-2
NO	NO E.D.P.	5559-11P5	11	W/O EAR	PASSIVE	94V-2
NO	NO E.D.P.	5559-11P4-2 I0	11	W/EARS	PASSIVE	94V-0
NO	NO E.D.P.	5559-11P5-2 I0	11	W/O EAR	PASSIVE	94V-0
NO	NO E.D.P.	5559-12P4	12	W/EARS	PASSIVE	94V-2
NO	NO E.D.P.	5559-12P5	12	W/O EAR	PASSIVE	94V-2
NO	NO E.D.P.	5559-12P4-2 I0	12	W/EARS	PASSIVE	94V-0
NO	NO E.D.P.	5559-12P5-2 I0	12	W/O EAR	PASSIVE	94V-0

THIS DRAWING REPLACES DRAWING SD-5559-NLP+

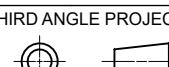
THIS DRAWING CONTAINS INFORMATION THAT IS PROPRIETARY TO MOLEX ELECTRONIC TECHNOLOGIES, LLC AND SHOULD NOT BE USED WITHOUT WRITTEN PERMISSION											
DIMENSION UNITS IN/MM		SCALE 1:1		CURRENT REV DESC: REMOVED OBSOLETE PART NUMBER AS PER PCN#511918							
GENERAL TOLERANCES (UNLESS SPECIFIED)				EC NO: 703993							
4 PLACES ±		MM		DRWN: SUGEEB				2022/04/07			
3 PLACES ±		INCH		CHK'D: GGA				2022/04/25			
2 PLACES ± 0.25				APPR: GGA				2022/04/25			
1 PLACE ± 0.38				INITIAL REVISION:							
0 PLACES ±				DRWN: KSS				1989/02/19			
ANGULAR TOL ± 0.5 °				APPR: FSMITH				2011/03/10			
DRAFT WHERE APPLICABLE MUST REMAIN WITHIN DIMENSIONS		THIRD ANGLE PROJECTION		DRAWING		SERIES		DOCUMENT NUMBER		DOC TYPE DOC PART REVISION	
				C-SIZE		5559		55590002-SD		PSD 000 A1	
								MATERIAL NUMBER		SHEET NUMBER	
								SEE TABLE		3 OF 3	
								GENERAL MARKET			

LEGEND

