

4

3

2

1

© - TE Connectivity. All Rights Reserved.

REVISIONS

P	LTR	DESCRIPTION	DATE	DWN	APVD
	G	CHANGE BASE MATERIAL TO PBT, DIMENSION CHANGE, CANCEL SEMKO ECN-21	15-JUL-21	XRL	K.T

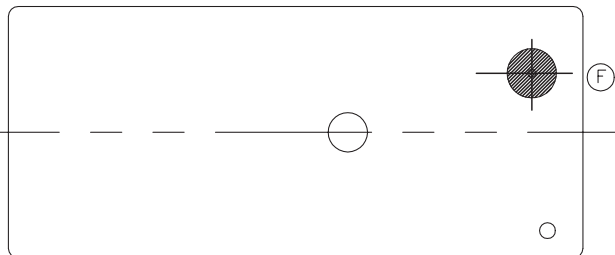

- NOTES:
 1.-SS-:PLASTIC SEALED TYPE
 2.LOT NO. SYSTEM AS FOLLOWING:

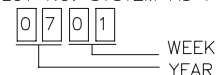

- 3.GENERAL TOLERANCE AS FOLLOWING:

TOLERANCE	
0~0.99mm	±0.1
1mm~2.99mm	±0.2
3mmMIN.	±0.3

- (E) 4.TERMINAL DIMENSION IS NOT INCLUDING SOLDER TIP.
 FOR THE TIN-PLATING OF THE PINS:
 +0.1mm FOR WIDTH,THICKNESS AND DIAMETER.
 +0.5mm FOR LENGTH.

(E)

PART A PART B C:MADE IN CHINA

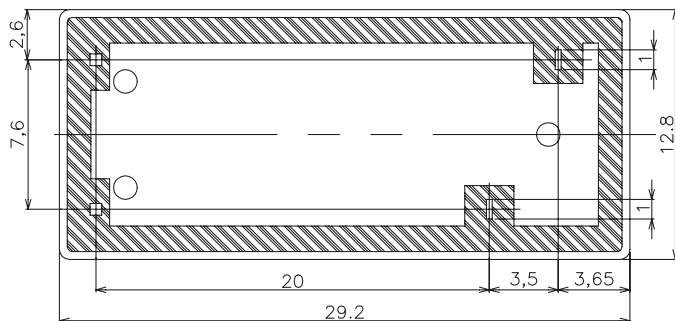
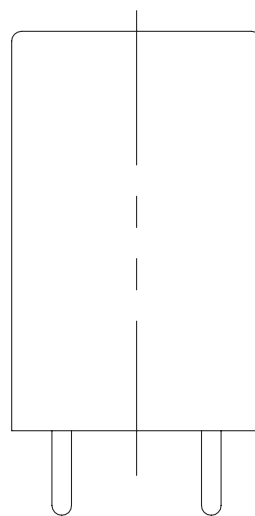
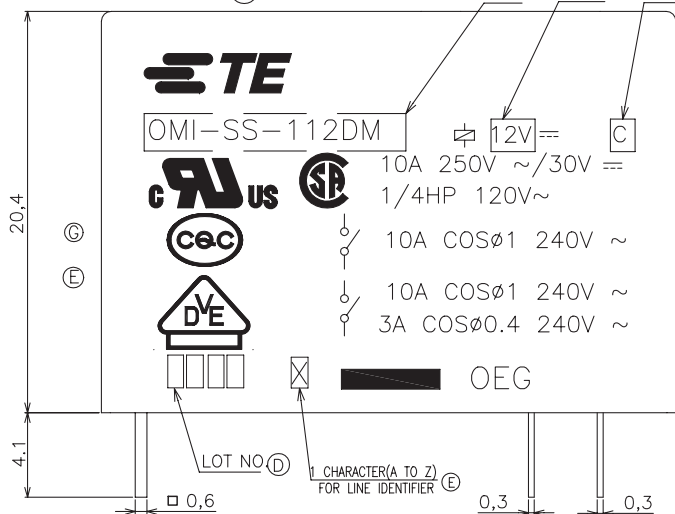

THIS DRAWING IS A CONTROLLED DOCUMENT.		DWN H.SASAKI	TE Connectivity		
DIMENSIONS: mm		CHK Y.OIKAWA			
TOLERANCES UNLESS OTHERWISE SPECIFIED:		APVD A.NAGAI	OMI-SH-D/L CUSTOMER DRAWING		
0 PLC ± - 1 PLC ± - 2 PLC ± - 3 PLC ± - 4 PLC ± - ANGLES ± - FINISH		PRODUCT SPEC -	RESTRICTED TO		
MATERIAL		APPLICATION SPEC -	SIZE A3	CAGE CODE 00779	DRAWING NO C=6-1419144-2
		WEIGHT -	CUSTOMER DRAWING		
		SCALE 1:1		SHEET 1 of 2	REV G

4

3

2

1

© - TE Connectivity. All Rights Reserved.

REVISIONS

P	LTR	DESCRIPTION	DATE	DWN	APVD

CONNECTION DIAGRAM (BOTTOM VIEW)

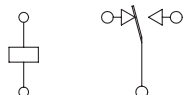

DRILLING DIAGRAM(2/1) (BOTTOM VIEW)

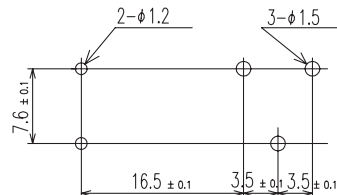

1-1419122-4	OMI-SH-124LM	24V	OMI-SH-124LM
1419122-6	OMI-SH-112LM	12V	OMI-SH-112LM
1419122-2	OMI-SH-112DM	12V	OMI-SH-112DM
6-1419144-2	OMI-SH-106DM	6V	OMI-SH-106DM
PART NO	TE TYPE NAME	PART B	PART A

RELAY TYPE

		EPOXY RESIN	RESIN	17
UL94 V-0		PBT	CASE	16
		—	TAPE	15
CLASS E		UEW	MAGNETIC WIRE	14
UL94 V-0		PBT	BASE	13
UL94 V-0		PBT	BOBBIN	12
	SOLDER DIP	CP WIRE	COIL TERMINAL	11
UL94 V-0		PPS	CARD	10
		Ag ALLOY	MOVABLE CONTACT	9
		Ag ALLOY	STATIONARY CONTACT	8
		Cu ALLOY	HINGE SPRING	7
	SOLDER DIP	Cu ALLOY	B TERMINAL	6
	SOLDER DIP	Cu ALLOY	M TERMINAL	5
	SOLDER DIP	Cu ALLOY	MOVABLE SPRING	4
		STEEL	CORE	3
		STEEL	ARMATURE	2
		STEEL	YOKE	1
INCOMBUSTIBILITY	TREATMENT	MATERIAL	DESCRIPTION	ITEM

THIS DRAWING IS A CONTROLLED DOCUMENT.		DWN H.SASAKI														
DIMENSIONS: mm		CHK Y.OIKAWA														
TOLERANCES UNLESS OTHERWISE SPECIFIED:		APVD A.NAGAI	NAME OMI-SH-D/L CUSTOMER DRAWING													
<table border="1"> <tr><td>0 PLC</td><td>± -</td></tr> <tr><td>1 PLC</td><td>± -</td></tr> <tr><td>2 PLC</td><td>± -</td></tr> <tr><td>3 PLC</td><td>± -</td></tr> <tr><td>4 PLC</td><td>± -</td></tr> </table>		0 PLC	± -	1 PLC	± -	2 PLC	± -	3 PLC	± -	4 PLC	± -	PRODUCT SPEC —	SIZE A3	CAGE CODE 00779	DRAWING NO C=6-1419144-2	RESTRICTED TO —
0 PLC	± -															
1 PLC	± -															
2 PLC	± -															
3 PLC	± -															
4 PLC	± -															
MATERIAL —		FINISH —	APPLICATION SPEC —	WEIGHT —	SCALE 1:1	SHEET 2 OF 2										
CUSTOMER DRAWING			REV G													