

VDC	1200 V
I <sub>F</sub>	50 A
T <sub>j,max</sub>	175 °C

## 1200V SiC Power Module Dual Diode Pack

### Features

- SiC Schottky Diode
  - Zero reverse recovery
  - Zero forward recovery
  - Temperature independent switching behavior
  - Positive temperature coefficient on V<sub>F</sub>
- Low stray inductance
- High junction temperature operation
- All parts tested to greater than 1,400V

### Benefits

- Outstanding performance at high frequency operation
- Low loss and low EMI noise
- Very rugged and easy mounting
- Internally isolated package (AIN)
- Low junction to case thermal resistance
- Easy paralleling due to positive T<sub>C</sub> of V<sub>F</sub>
- RoHS compliant

### Applications

- Switched-mode power supply
- Induction heater
- Welding equipment
- Charging station

### Package

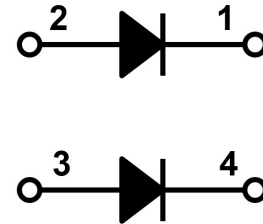

Parallel

Part #	Package	Marking
GHXS050B120S-D3	SOT-227	GHXS050B120S-D3



**Maximum Ratings**, at T<sub>j</sub>=25 °C, unless otherwise specified (per leg)

Characteristics	Symbol	Conditions	Values	Unit
Continuous forward current	I <sub>F</sub>	T <sub>C</sub> =25 °C, T <sub>J</sub> =175 °C	101	A
		T <sub>C</sub> =130 °C, T <sub>J</sub> =175 °C	50	
		T <sub>C</sub> =150 °C, T <sub>J</sub> =175 °C	34	
Surge non-repetitive forward current sine halfwave	I <sub>FSM</sub>	T <sub>C</sub> =25 °C, t <sub>p</sub> =8.3 ms	390	A
		T <sub>C</sub> =110 °C, t <sub>p</sub> =8.3 ms	340	
Non-repetitive peak forward current	I <sub>F,max</sub>	T <sub>C</sub> =25 °C, t <sub>p</sub> =10 μs	2000**	A
i <sup>2</sup> t value	∫i <sup>2</sup> dt	T <sub>C</sub> =25 °C, t <sub>p</sub> =8.3 ms	631	A <sup>2</sup> s
		T <sub>C</sub> =110 °C, t <sub>p</sub> =8.3 ms	480	
Repetitive peak reverse voltage	V <sub>RRM</sub>	T <sub>J</sub> =25 °C	1200	V
Diode dv/dt ruggedness	dv/dt	Turn-on slew rate, repetitive	200	V/ns
Power dissipation	P <sub>tot</sub> *	T <sub>C</sub> =25 °C	349	W
Operating junction temperature	T <sub>J</sub>		-55... 175	°C
Storage temperature	T <sub>storage</sub>		-55... 150	°C

**Notes:** \*Typical R<sub>thjC</sub> used

\*\*Limited by testing equipment

# 1200V SiC Power Module

# GHXS050B120S-D3

Electrical Characteristics, at  $T_j=25\text{ }^\circ\text{C}$ , unless otherwise specified (per leg)

Characteristics	Symbol	Conditions	Values			Unit
			min.	typ.	max.	
DC blocking voltage	$V_{DC}$	$I_R=100\mu\text{A}$ , $T_j=25\text{ }^\circ\text{C}$	1200	-	-	V
Breakdown voltage	$V_{BR}$	$I_R=2\text{mA}$ , $T_j=25\text{ }^\circ\text{C}$	1400	-	-	V
Diode forward voltage	$V_F$	$I_F=50\text{A}$ , $T_j=25\text{ }^\circ\text{C}$	-	1.5	1.7	V
		$I_F=50\text{A}$ , $T_j=125\text{ }^\circ\text{C}$	-	1.8	-	
		$I_F=50\text{A}$ , $T_j=175\text{ }^\circ\text{C}$	-	2.1	2.7	
Reverse current	$I_R$	$V_R=1,200\text{V}$ , $T_j=25\text{ }^\circ\text{C}$	-	6	100	$\mu\text{A}$
		$V_R=1,400\text{V}$ , $T_j=25\text{ }^\circ\text{C}$	-	35	-	
		$V_R=1,200\text{V}$ , $T_j=125\text{ }^\circ\text{C}$	-	49	-	
		$V_R=1,200\text{V}$ , $T_j=175\text{ }^\circ\text{C}$	-	193	750	
Total capacitive charge	$Q_C$	$V_R=800\text{V}$ , $T_j=25\text{ }^\circ\text{C}$	-	269	-	nC
Total capacitance	C	$V_R=1\text{V}$ , $f=1\text{ MHz}$	-	3040	-	pF
		$V_R=400\text{V}$ , $f=1\text{ MHz}$	-	253	-	
		$V_R=800\text{V}$ , $f=1\text{ MHz}$	-	181	-	

Thermal and Package Characteristics, at  $T_j=25\text{ }^\circ\text{C}$ , unless otherwise specified

Characteristics	Symbol	Conditions	Values			Unit
			min.	typ.	max.	
Thermal resistance, junction-case	$R_{thJC}$	Per leg	-	0.43	0.52	$^\circ\text{C/W}$
Mounting torque	$M_d$	M4-0.7 screws	1.1	-	1.5	N-m
Terminal connection torque	$M_{dt}$	M4-0.7 screws	-	1.1	1.3	N-m
Package weight	$W_t$		-	32	-	g
Isolation voltage	$V_{ISOL}$	$I_{ISOL} < 1\text{mA}$ , 50/60 Hz, 1 min	2500	-	-	V

## Typical Performance Per Leg

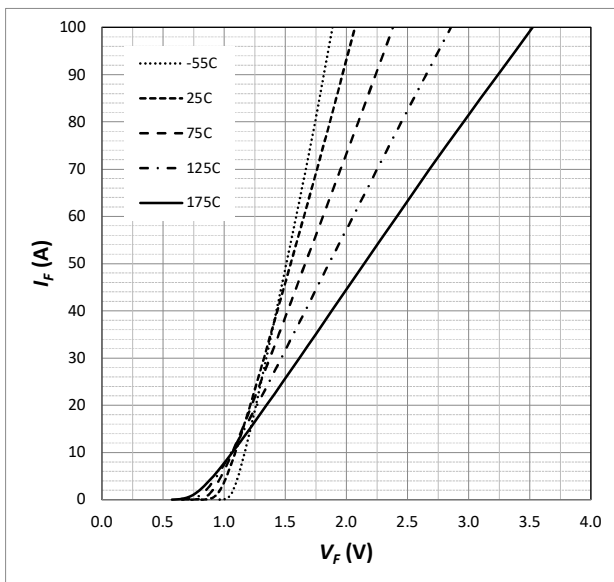

Fig. 1 Forward Characteristics (parameterized on  $T_j$ )

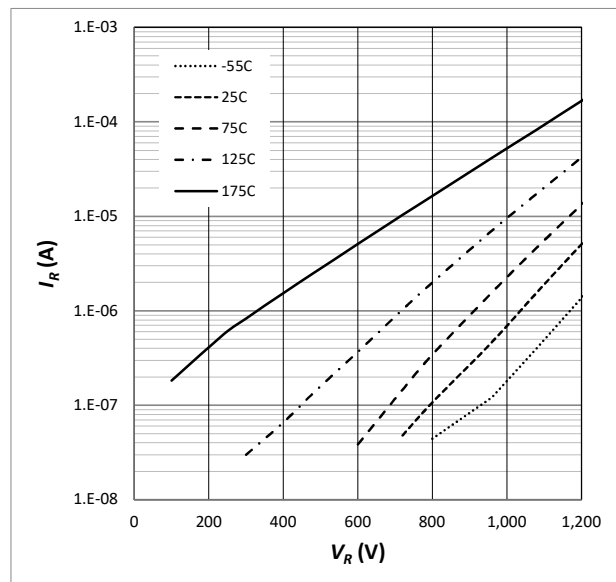

Fig. 2 Reverse Characteristics (parameterized on  $T_j$ )

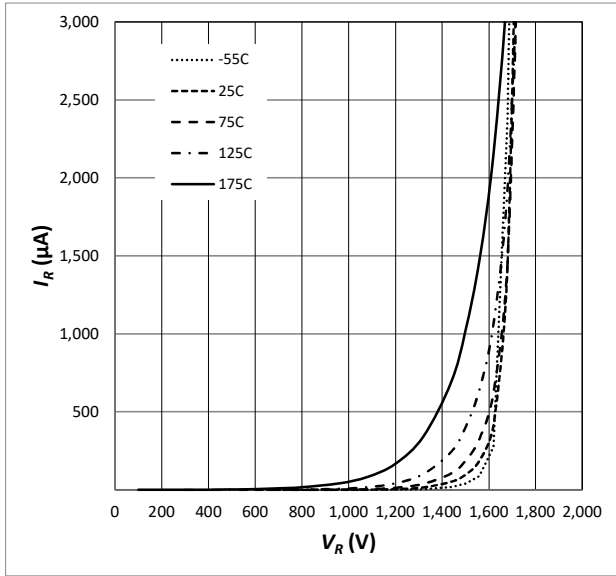

Fig. 3 Reverse Characteristics (parameterized on  $T_j$ )

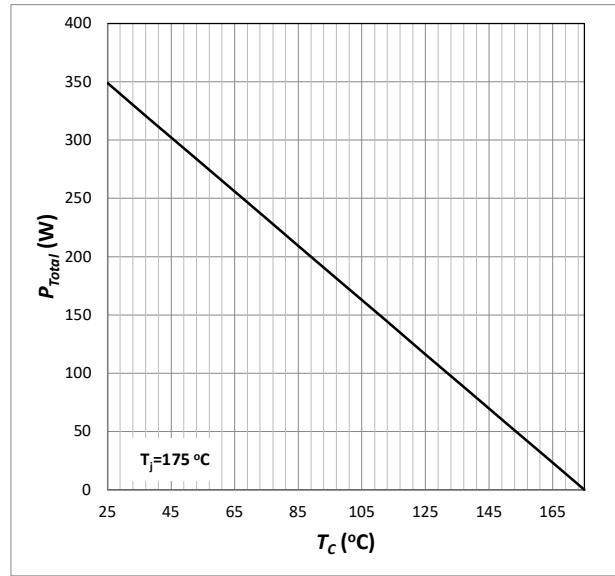

Fig. 4 Power Derating

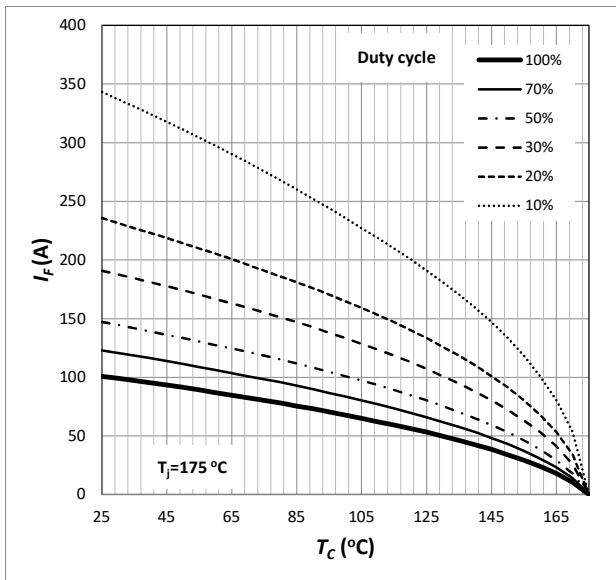

Fig. 5 Current Derating

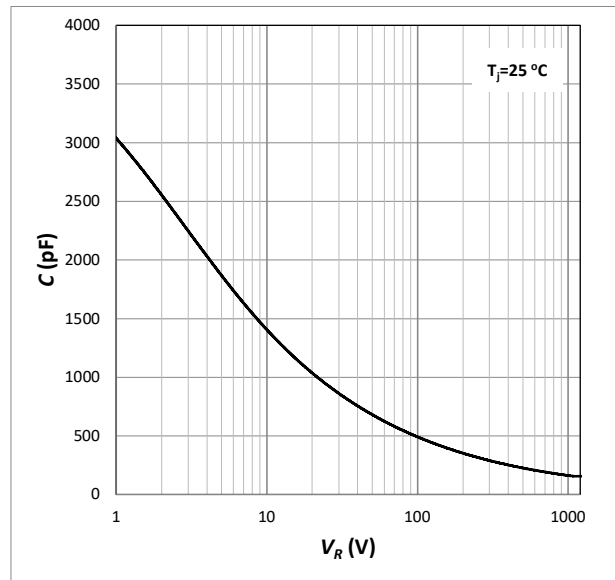

Fig. 6 Capacitance

# 1200V SiC Power Module

# GHXS050B120S-D3

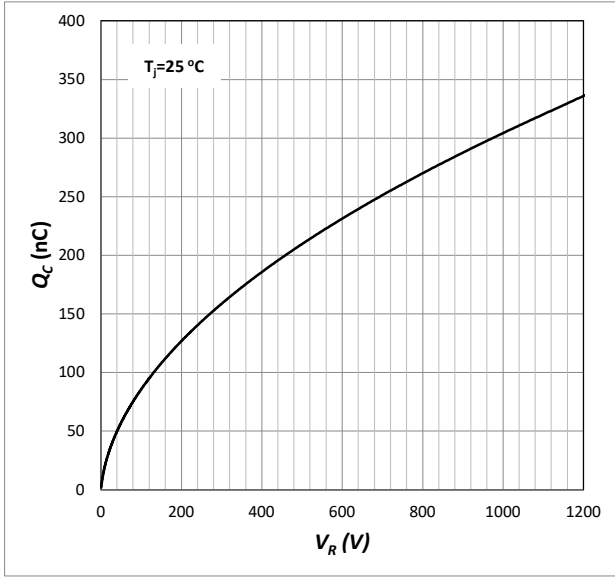

Fig. 7 Capacitive Charge

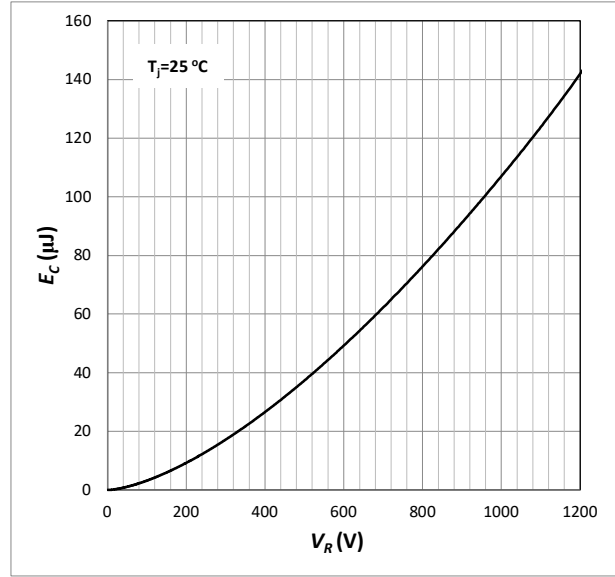

Fig. 8 Typical Capacitance Stored Energy

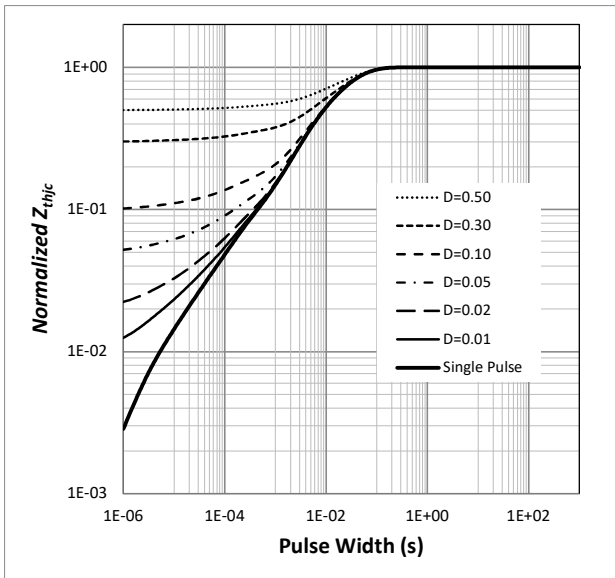
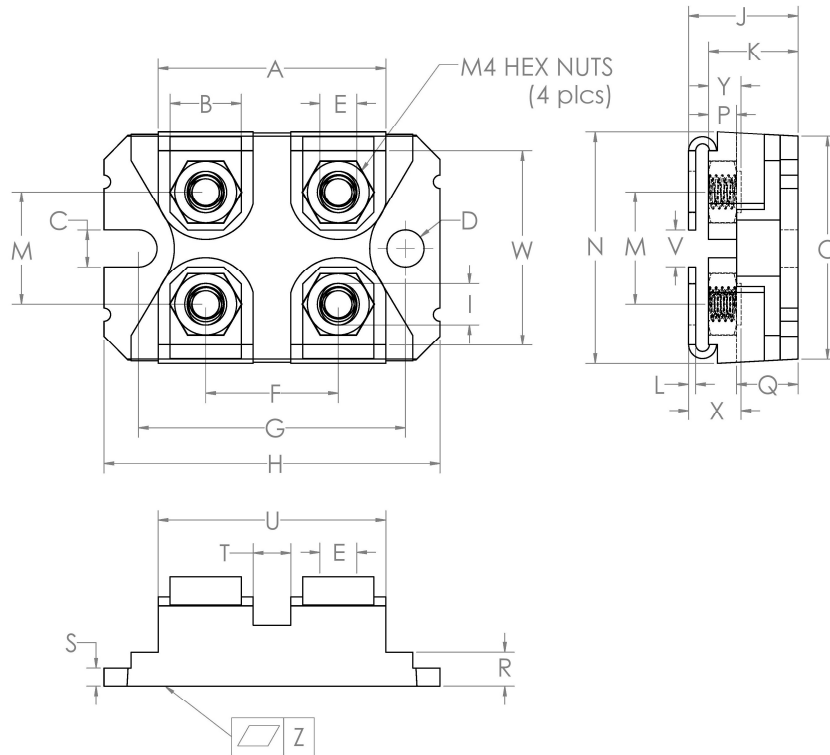

Fig. 9 Transient Thermal Impedance

# 1200V SiC Power Module

# GHXS050B120S-D3

## Package Dimensions SOT-227



Sym	Millimeters		Inches	
	Min	Max	Min	Max
A	31.67	31.90	1.247	1.256
B	7.95	8.18	0.313	0.322
C	4.14	4.24	0.163	0.167
D	4.14	4.24	0.163	0.167
E	4.14	4.24	0.163	0.167
F	14.94	15.09	0.588	0.594
G	30.15	30.25	1.187	1.191
H	38.00	38.10	1.496	1.500
I	4.75	4.83	0.187	0.190
J	11.68	12.19	0.460	0.480
K	9.45	9.60	0.372	0.378
L	0.76	0.84	0.030	0.033
M	12.62	12.88	0.497	0.507
N	25.15	25.30	0.990	0.996
O	24.79	25.04	0.976	0.986
P	3.02	3.15	0.119	0.124
Q	6.71	6.96	0.264	0.274
R	4.17	4.42	0.164	0.174
S	2.08	2.13	0.082	0.084
T	3.28	3.63	0.129	0.143
U	26.75	26.90	1.053	1.059
V	3.86	4.24	0.152	0.167
W	20.55	26.90	0.809	0.814
X	5.45	5.85	0.215	0.230
Y	3.15	3.66	0.124	0.144
Z	0.00	0.13	0.000	0.005

# 1200V SiC Power Module

# GHXS050B120S-D3

## Revision History

Date	Revision	Notes
9/4/2020	1.0	Initial release

## Notes

### **RoHS Compliance**

The levels of RoHS restricted materials in this product are below the maximum concentration values (also referred to as the threshold limits) permitted for such substances, or are used in an exempted application, in accordance with EU Directive 2011/65/EC (RoHS2), as implemented March, 2013. RoHS Declarations for this product can be obtained from the Product Documentation sections of [www.SemiQ.com](http://www.SemiQ.com).

### **REACH Compliance**

REACH substances of high concern (SVHC) information is available for this product. Since the European Chemicals Agency (ECHA) has published notice of their intent to frequently revise the SVHC listing for the foreseeable future, please contact our office at SemiQ Headquarters in Lake Forest, California to insure you get the most up-to-date REACH SVHC Declaration. REACH banned substance information (REACH Article 67) is also available upon request.

SemiQ Inc., reserves the right to make changes to the product specifications and data in this document without notice. SemiQ products are sold pursuant to SemiQ's terms and conditions of sale in place at the time of order acknowledgement.

This product has not been designed or tested for use in, and is not intended for use in, applications implanted into the human body nor in applications in which failure of the product could lead to death, personal injury or property damage, including but not limited to equipment used in the operation of nuclear facilities, life-support machines, cardiac defibrillators or similar emergency medical equipment, aircraft navigation or communication or control systems, or air traffic control.

SemiQ makes no warranty, representation or guarantee regarding the suitability of its products for any particular purpose, nor does SemiQ assume any liability arising out of the application or use of any product or circuit, and specifically disclaims any and all liability, including without limitation special, consequential or incidental damages. Buyer is responsible for its products and applications using SemiQ products.

To obtain additional technical information or to place an order for this product, please contact us. The information in this datasheet is provided by SemiQ. SemiQ reserves the right to make changes, corrections, modifications, and improvements of datasheet without notice.