

## CARMEN-50-W-C

~55° wide beam. Assembly with holder C compatible with LEDiL HEKLA.

### TECHNICAL SPECIFICATIONS:

Dimensions	Ø 50.0 mm
Height	25.5 mm
Fastening	socket
ROHS compliant	yes ⓘ

### MATERIAL SPECIFICATIONS:

Component	Type	Material	Colour	Finish
CARMEN-50-W	Single lens	PMMA	clear	
CARMEN-50-HLD-C	Holder	PC	black	

### ORDERING INFORMATION:



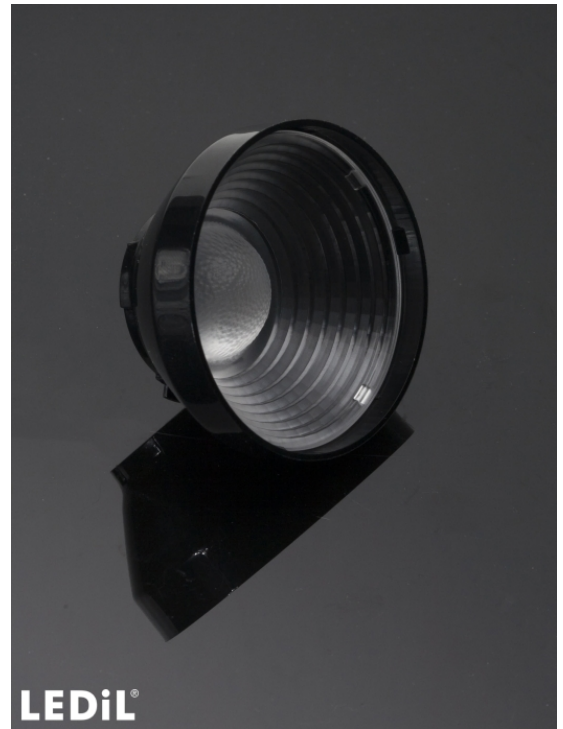

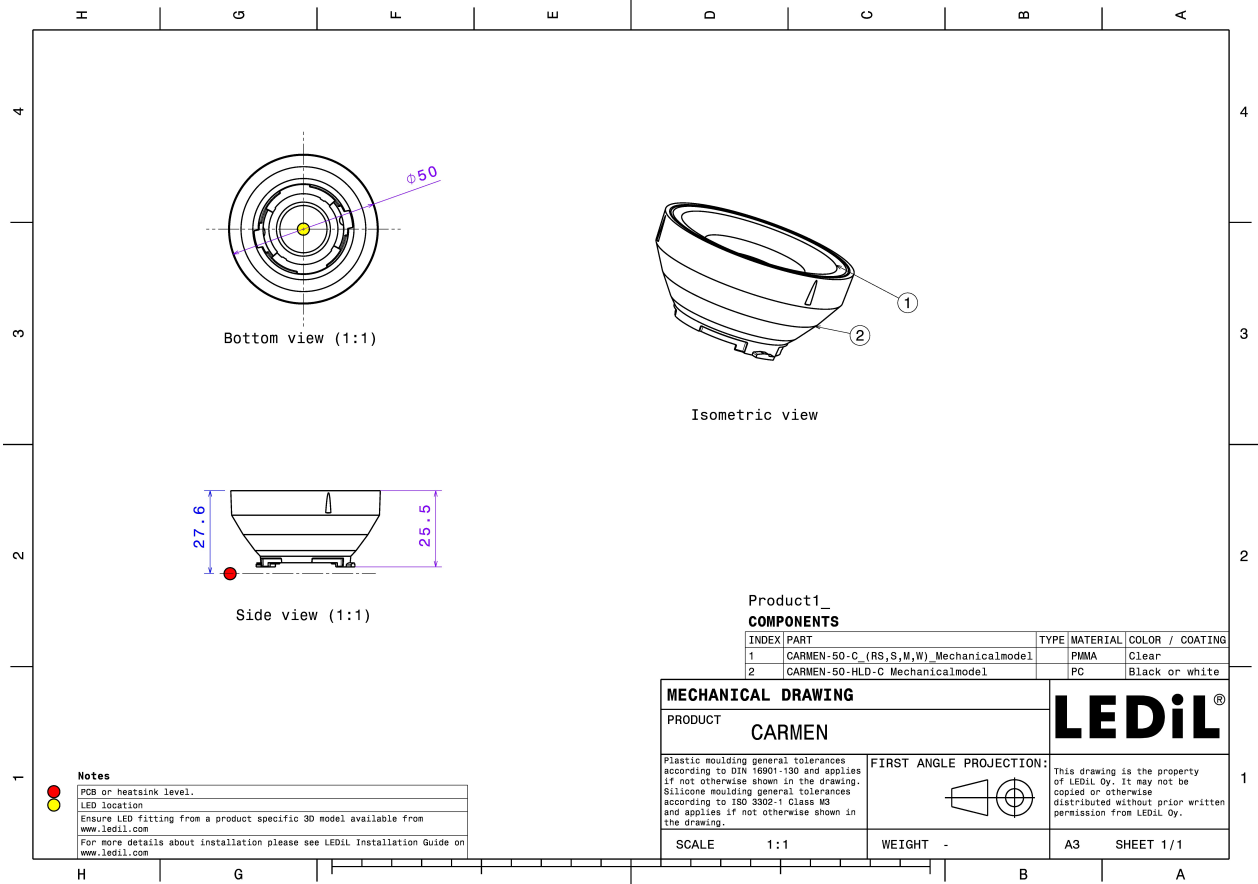
Component	Type	Qty in box	MOQ	MPQ	Box weight (kg)
CP16109_CARMEN-50-W-C » Box size: 476 x 273 x 292 mm	Single lens	308	112	28	5.7





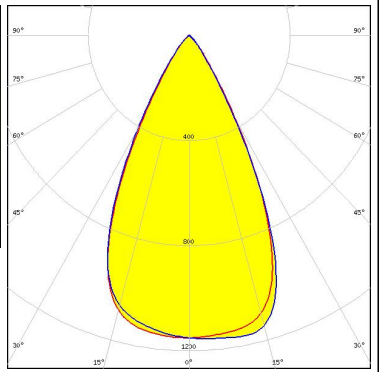

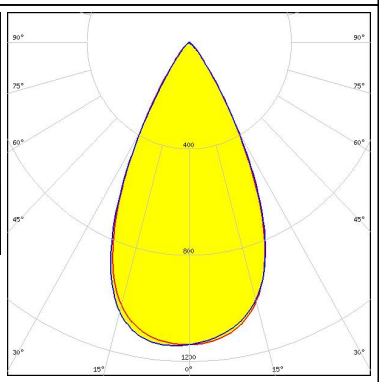
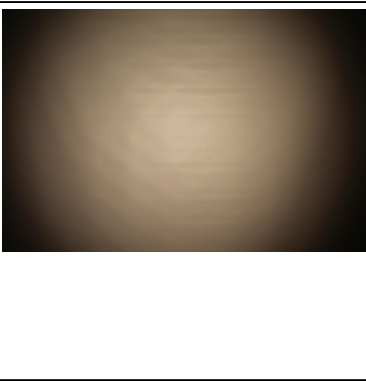
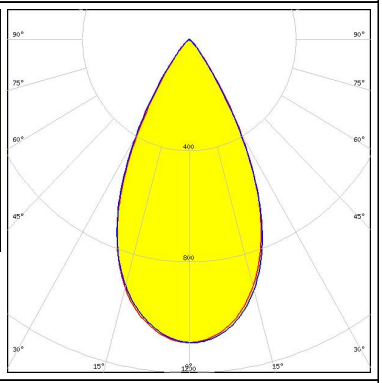

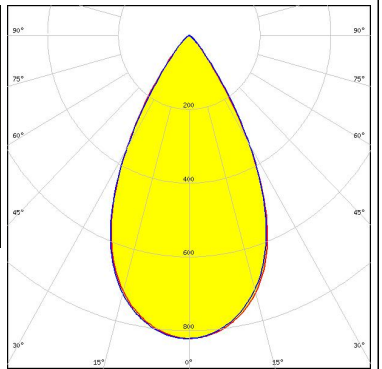

See also our general installation guide: [www.ledil.com/installation\\_guide](http://www.ledil.com/installation_guide)

#### PHOTOMETRIC DATA (MEASURED):

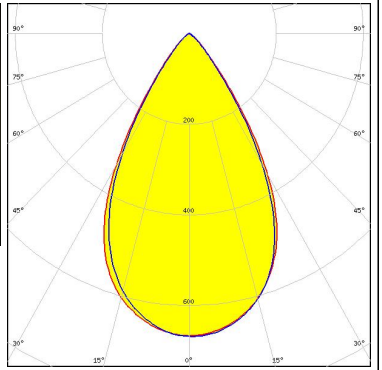
<p>bridgelux.</p> <p>LED V4 HD</p> <p>FWHM / FWTM 54.0° / 75.0°</p> <p>Efficiency 88 %</p> <p>Peak intensity 1.2 cd/m</p> <p>LEDs/each optic 1</p> <p>Light colour White</p> <p>Required components: F15253_HEKLA-SOCKET-A</p>		
<p>bridgelux.</p> <p>LED V6 HD</p> <p>FWHM / FWTM 53.0° / 76.0°</p> <p>Efficiency 84 %</p> <p>Peak intensity 1.1 cd/m</p> <p>LEDs/each optic 1</p> <p>Light colour White</p> <p>Required components: F15255_HEKLA-SOCKET-C</p>		
<p>bridgelux.</p> <p>LED V9 HD</p> <p>FWHM / FWTM 53.0° / 76.0°</p> <p>Efficiency 80 %</p> <p>Peak intensity 1.1 cd/m</p> <p>LEDs/each optic 1</p> <p>Light colour White</p> <p>Required components: F15859_HEKLA-SOCKET-I</p>		
<p>bridgelux.</p> <p>LED VERO13</p> <p>FWHM / FWTM 56.0° / 80.0°</p> <p>Efficiency 68 %</p> <p>Peak intensity 0.8 cd/m</p> <p>LEDs/each optic 1</p> <p>Light colour White</p> <p>Required components: C16142_HEKLA-SOCKET-K</p>		

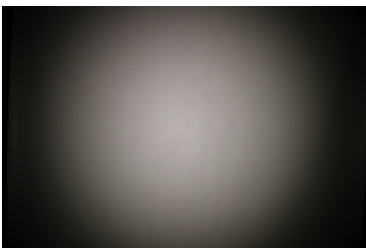
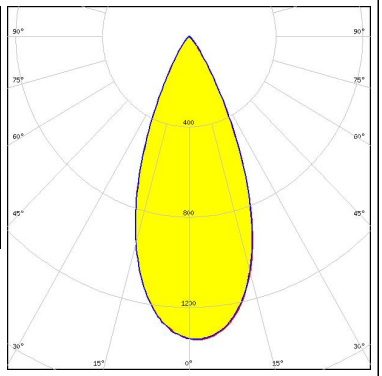
#### PHOTOMETRIC DATA (MEASURED):

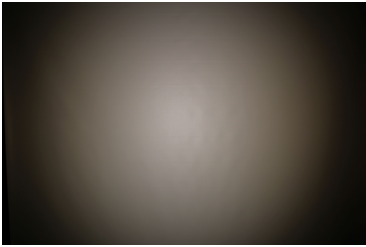
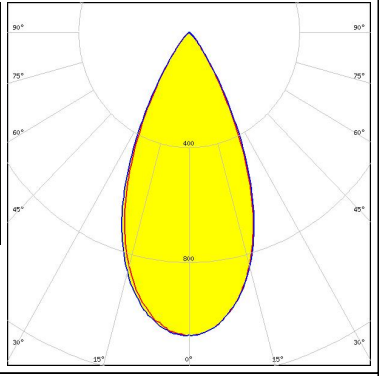
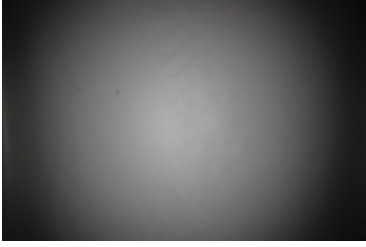
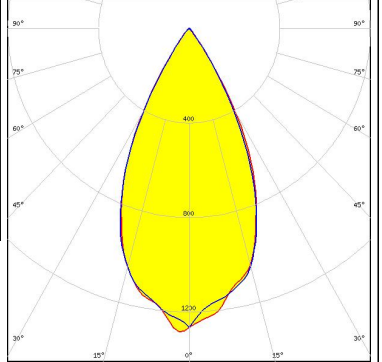
<p></p> <p>LED Vesta DTW 13mm (21W)            FWHM / FWTM 60.0° / 85.0°            Efficiency 62 %            Peak intensity 0.7 cd/lm            LEDs/each optic 1            Light colour Tunable White</p> <p>Required components:            C16142_HEKLA-SOCKET-K            Bender Wirth: 491 Typ L8</p>		
<p></p> <p>LED Vesta TW 6mm DP            FWHM / FWTM 43.0° / 67.0°            Efficiency 71 %            Peak intensity 1.3 cd/lm            LEDs/each optic 1            Light colour White</p> <p>Required components:            C16142_HEKLA-SOCKET-K            Bender Wirth: 504 Typ L8</p>		
<p></p> <p>LED Vesta TW 9mm (9W) DP            FWHM / FWTM 48.0° / 73.0°            Efficiency 68 %            Peak intensity 1.1 cd/lm            LEDs/each optic 1            Light colour White</p> <p>Required components:            C16142_HEKLA-SOCKET-K            Bender Wirth: 489 Typ L8</p>		
<p><b>CITIZEN</b></p> <p>LED CLL02x/CLU02x (LES10)            FWHM / FWTM 54.0° / 81.0°            Efficiency 80 %            Peak intensity 1 cd/lm            LEDs/each optic 1            Light colour White</p> <p>Required components:            F15255_HEKLA-SOCKET-C</p>		

#### PHOTOMETRIC DATA (MEASURED):

#### CITIZEN

LED CLU700/701/702  
 FWHM / FWTM 52.0° / 76.0°  
 Efficiency 85 %  
 Peak intensity 1.2 cd/lm  
 LEDs/each optic 1  
 Light colour White  
 Required components:  
 F15255\_HEKLA-SOCKET-C

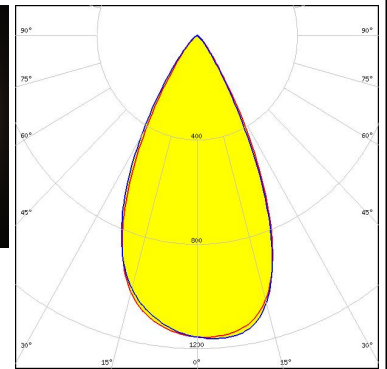
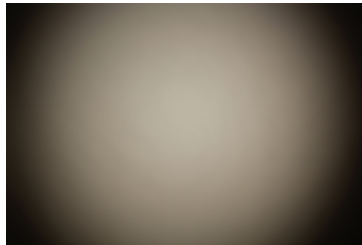

#### CITIZEN

LED CLU710/711  
 FWHM / FWTM 52.0° / 77.0°  
 Efficiency 78 %  
 Peak intensity 1.1 cd/lm  
 LEDs/each optic 1  
 Light colour White  
 Required components:  
 F15859\_HEKLA-SOCKET-I

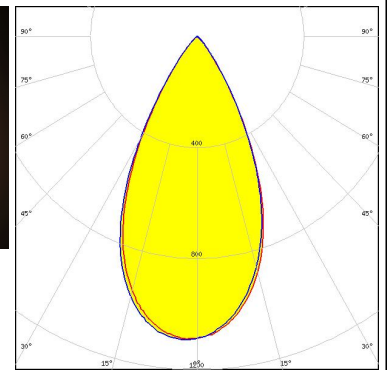
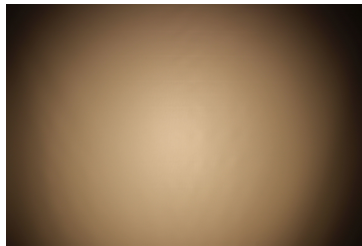

#### CITIZEN

LED CLU7A2 (LES 4.2mm)  
 FWHM / FWTM 53.0° / 73.0°  
 Efficiency 87 %  
 Peak intensity 1.2 cd/lm  
 LEDs/each optic 1  
 Light colour White  
 Required components:  
 F15255\_HEKLA-SOCKET-C

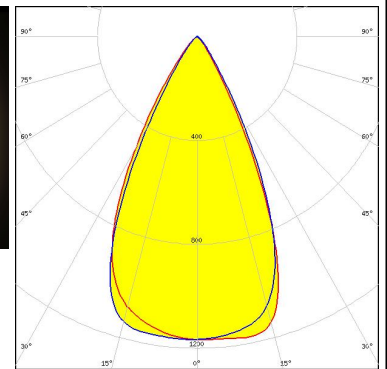

#### CITIZEN

LED CLU7B2  
 FWHM / FWTM 51.0° / 72.0°  
 Efficiency 85 %  
 Peak intensity 1.2 cd/lm  
 LEDs/each optic 1  
 Light colour White  
 Required components:  
 F15255\_HEKLA-SOCKET-C

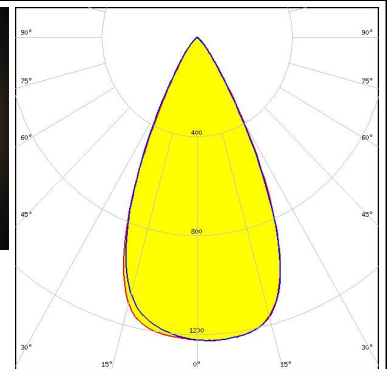
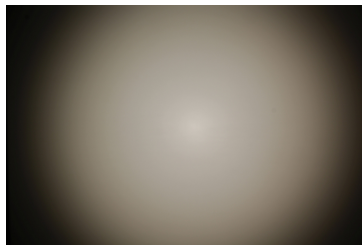

#### PHOTOMETRIC DATA (MEASURED):



LED CMA1516  
 FWHM / FWTM 57.0° / 81.0°  
 Efficiency 83 %  
 Peak intensity 1 cd/lm  
 LEDs/each optic 1  
 Light colour White  
 Required components:  
 F15256\_HEKLA-SOCKET-D

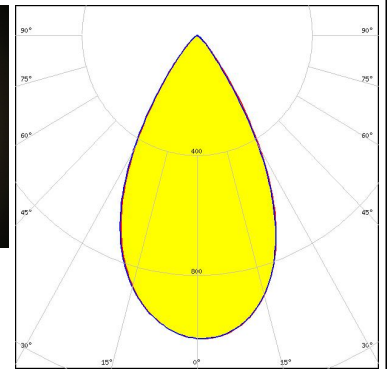
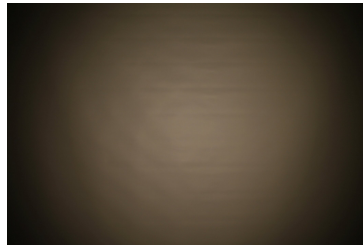

LED CMT14xx  
 FWHM / FWTM 55.0° / 81.0°  
 Efficiency 54 %  
 Peak intensity 0.7 cd/lm  
 LEDs/each optic 1  
 Light colour White  
 Required components:  
 F15255\_HEKLA-SOCKET-C

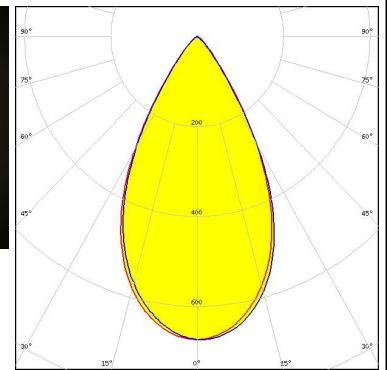
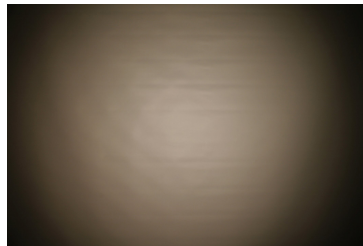

LED CXA/B 13xx  
 FWHM / FWTM 54.0° / 76.0°  
 Efficiency 88 %  
 Peak intensity 1.2 cd/lm  
 LEDs/each optic 1  
 Light colour White  
 Required components:  
 F15956\_HEKLA-SOCKET-J

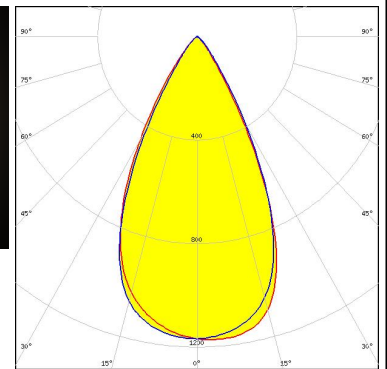
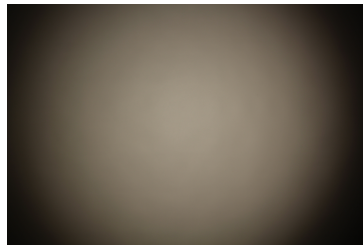

LED CXA/B 13xx  
 FWHM / FWTM 54.0° / 77.0°  
 Efficiency 86 %  
 Peak intensity 1.1 cd/lm  
 LEDs/each optic 1  
 Light colour White  
 Required components:  
 F15956\_HEKLA-SOCKET-J

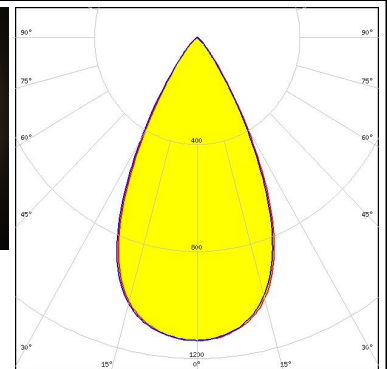
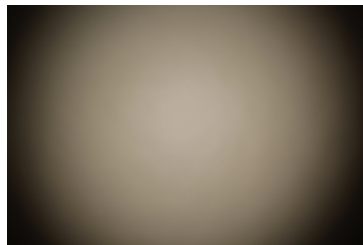

#### PHOTOMETRIC DATA (MEASURED):



LED CXA/B 15xx  
 FWHM / FWTM 56.0° / 81.0°  
 Efficiency 84 %  
 Peak intensity 1 cd/lm  
 LEDs/each optic 1  
 Light colour White  
 Required components:  
 F15256\_HEKLA-SOCKET-D

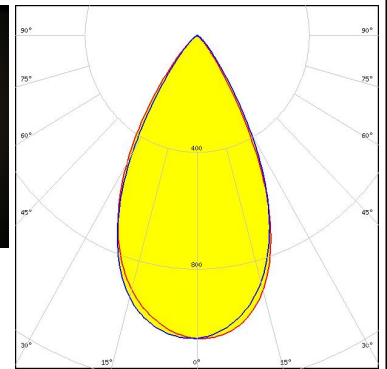
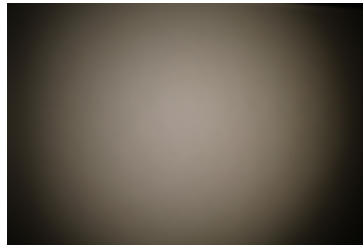

LED LUXEON CoB 1202HD  
 FWHM / FWTM 54.0° / 76.0°  
 Efficiency 85 %  
 Peak intensity 1.1 cd/lm  
 LEDs/each optic 1  
 Light colour White  
 Required components:  
 F15848\_HEKLA-SOCKET-G

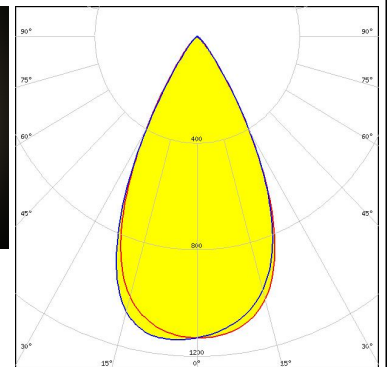
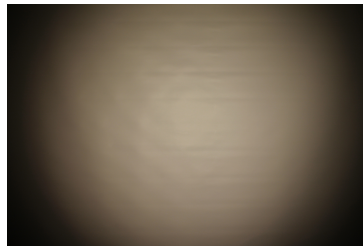

LED LUXEON CoB 1202s  
 FWHM / FWTM 52.0° / 75.0°  
 Efficiency 85 %  
 Peak intensity 1.2 cd/lm  
 LEDs/each optic 1  
 Light colour White  
 Required components:  
 F15848\_HEKLA-SOCKET-G

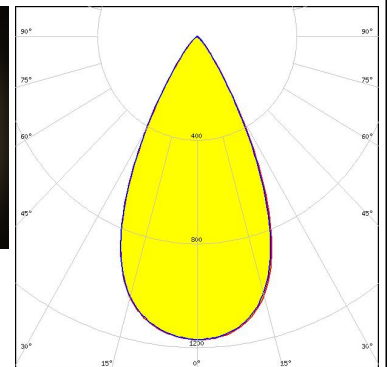
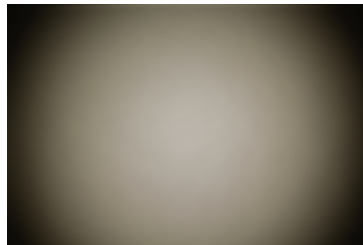

LED LUXEON CX Plus CoB - HD S01H4  
 FWHM / FWTM 45.0° / 67.0°  
 Efficiency 78 %  
 Peak intensity 1.4 cd/lm  
 LEDs/each optic 1  
 Light colour White  
 Required components:  
 Bender Wirth: 634c Hekla

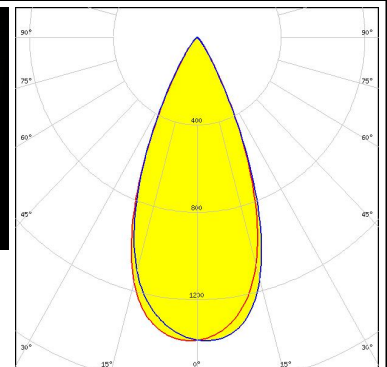
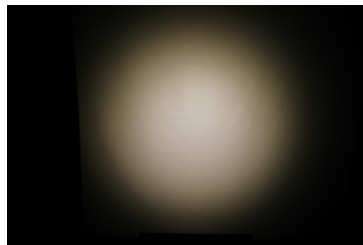



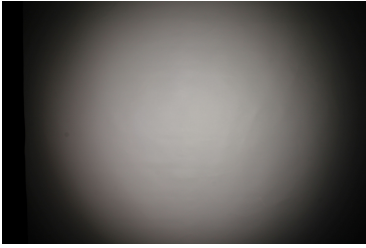
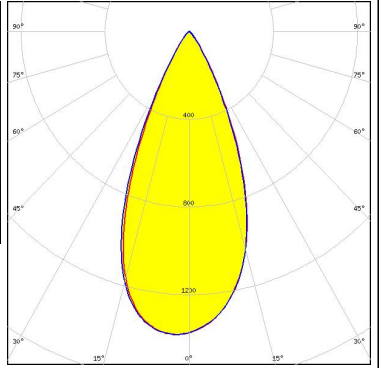
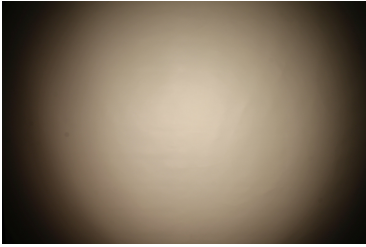
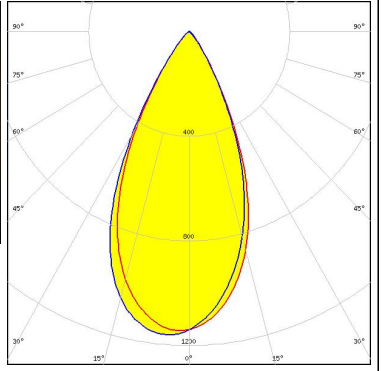
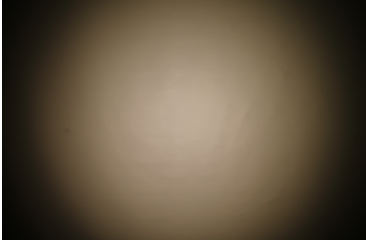
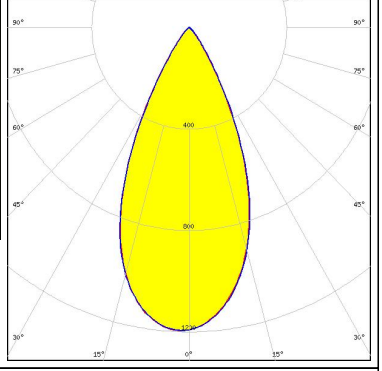
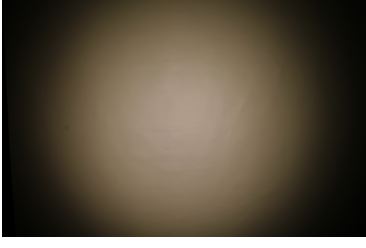
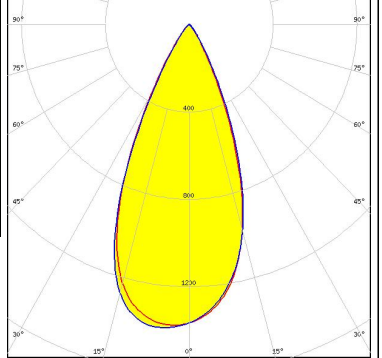

#### PHOTOMETRIC DATA (MEASURED):



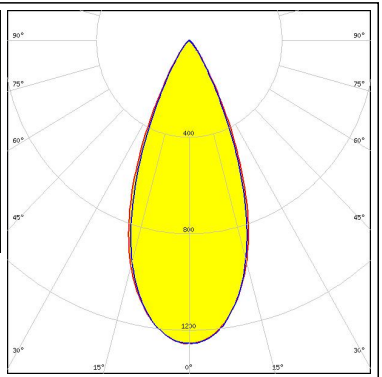

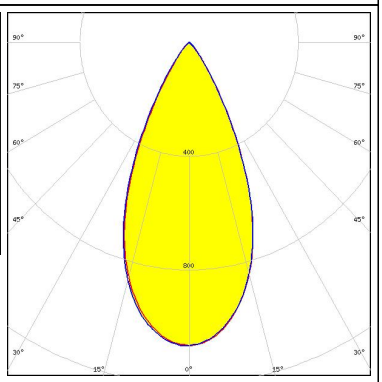
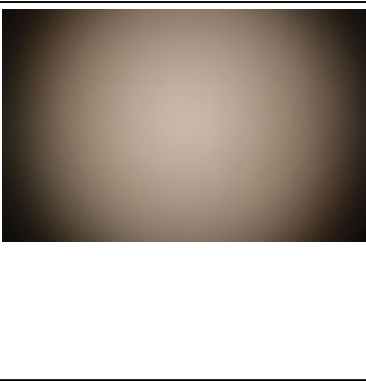
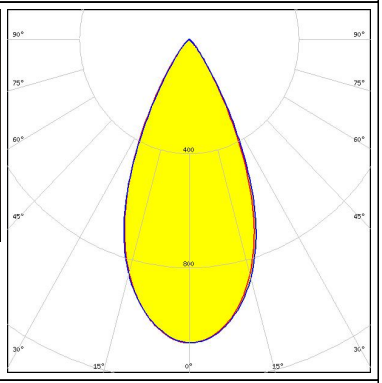

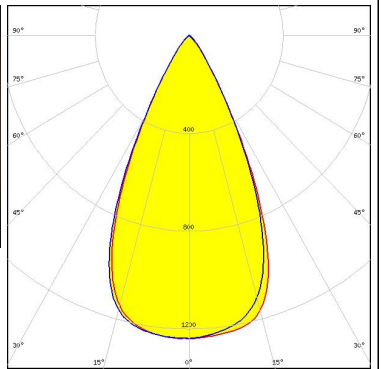
<p><b>LUMILEDS</b></p> <p>LED LUXEON CX Plus CoB - HD S01H6 / HD S02H6</p> <p>FWHM / FWTM 45.0° / 68.0°</p> <p>Efficiency 77 %</p> <p>Peak intensity 1.4 cd/lm</p> <p>LEDs/each optic 1</p> <p>Light colour White</p> <p>Required components: Bender Wirth: 634c Hekla</p>		
<p><b>LUMILEDS</b></p> <p>LED LUXEON CX Plus CoB - HD S04H9</p> <p>FWHM / FWTM 49.0° / 74.0°</p> <p>Efficiency 76 %</p> <p>Peak intensity 1.2 cd/lm</p> <p>LEDs/each optic 1</p> <p>Light colour White</p> <p>Required components: Bender Wirth: 634c Hekla</p>		
<p><b>LUMILEDS</b></p> <p>LED LUXEON CX Plus CoB M02 / M03 (Gen2)</p> <p>FWHM / FWTM 48.0° / 72.0°</p> <p>Efficiency 75 %</p> <p>Peak intensity 1.2 cd/lm</p> <p>LEDs/each optic 1</p> <p>Light colour White</p> <p>Required components: Bender Wirth: 641a Hekla</p>		
<p><b>LUMILEDS</b></p> <p>LED LUXEON CX Plus CoB S01 (Gen2)</p> <p>FWHM / FWTM 45.0° / 67.0°</p> <p>Efficiency 78 %</p> <p>Peak intensity 1.4 cd/lm</p> <p>LEDs/each optic 1</p> <p>Light colour White</p> <p>Required components: Bender Wirth: 634c Hekla</p>		

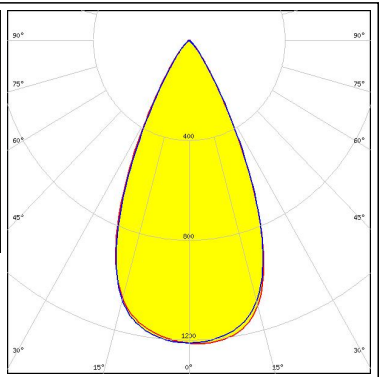

#### PHOTOMETRIC DATA (MEASURED):

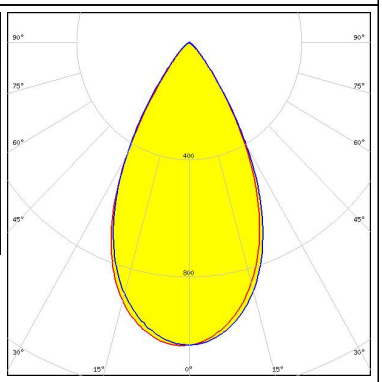
<p><b>LUMINUS</b></p> <p>LED CDM-6 (Dim-To-Warm)</p> <p>FWHM / FWTM 44.0° / 68.0°</p> <p>Efficiency 68 %</p> <p>Peak intensity 1.3 cd/lm</p> <p>LEDs/each optic 1</p> <p>Light colour White</p> <p>Required components: C16142_HEKLA-SOCKET-K Bender Wirth: 490 Typ L8</p>		
<p><b>LUMINUS</b></p> <p>LED CDM-9 (Dim-To-Warm)</p> <p>FWHM / FWTM 48.0° / 72.0°</p> <p>Efficiency 67 %</p> <p>Peak intensity 1.1 cd/lm</p> <p>LEDs/each optic 1</p> <p>Light colour White</p> <p>Required components: C16142_HEKLA-SOCKET-K Bender Wirth: 490 Typ L8</p>		
<p><b>LUMINUS</b></p> <p>LED CTM-9 (Tunable White)</p> <p>FWHM / FWTM 48.0° / 72.0°</p> <p>Efficiency 67 %</p> <p>Peak intensity 1 cd/lm</p> <p>LEDs/each optic 1</p> <p>Light colour White</p> <p>Required components: C16142_HEKLA-SOCKET-K Bender Wirth: 495 Typ L8</p>		
<p><b>LUMINUS</b></p> <p>LED CXM-3</p> <p>FWHM / FWTM 51.0° / 73.0°</p> <p>Efficiency 87 %</p> <p>Peak intensity 1.2 cd/lm</p> <p>LEDs/each optic 1</p> <p>Light colour White</p> <p>Required components: F15255_HEKLA-SOCKET-C</p>		

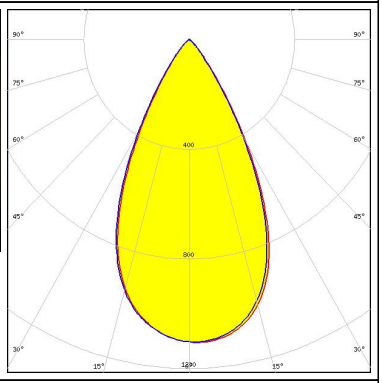
#### PHOTOMETRIC DATA (MEASURED):

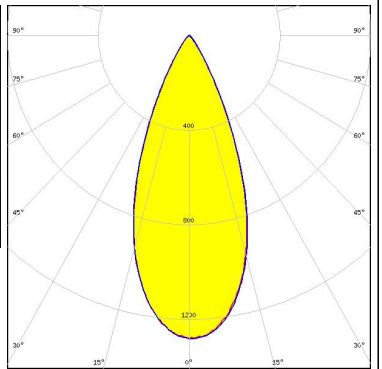
<p><b>LUMINUS</b></p> <p>LED CXM-4</p> <p>FWHM / FWTM 50.0° / 73.0°</p> <p>Efficiency 83 %</p> <p>Peak intensity 1.2 cd/lm</p> <p>LEDs/each optic 1</p> <p>Light colour White</p> <p>Required components: F15255_HEKLA-SOCKET-C</p>		
<p><b>LUMINUS</b></p> <p>LED CxM-9 (13.5x13.5)</p> <p>FWHM / FWTM 55.0° / 81.0°</p> <p>Efficiency 83 %</p> <p>Peak intensity 1 cd/lm</p> <p>LEDs/each optic 1</p> <p>Light colour White</p> <p>Required components: F15255_HEKLA-SOCKET-C</p>		
<p><b>NICHIA</b></p> <p>LED COB S-Type (LES 7)</p> <p>FWHM / FWTM 53.0° / 78.0°</p> <p>Efficiency 83 %</p> <p>Peak intensity 1.1 cd/lm</p> <p>LEDs/each optic 1</p> <p>Light colour White</p> <p>Required components: F15848_HEKLA-SOCKET-G</p>		
<p><b>NICHIA</b></p> <p>LED NJCWL024Z-V1MT: COB L-Type Tunable White</p> <p>FWHM / FWTM 42.0° / 67.0°</p> <p>Efficiency 66 %</p> <p>Peak intensity 1.3 cd/lm</p> <p>LEDs/each optic 1</p> <p>Light colour White</p> <p>Required components: C16142_HEKLA-SOCKET-K Bender Wirth: 497 Typ L8</p>		

#### PHOTOMETRIC DATA (MEASURED):



LED NVCWJ024Z-V1MT: COB J-Type Tunable White  
 FWHM / FWTM 49.0° / 74.0°  
 Efficiency 65 %  
 Peak intensity 1 cd/lm  
 LEDs/each optic 1  
 Light colour White  
 Required components:  
 C16142\_HEKLA-SOCKET-K  
 Bender Wirth: 498 Typ L8

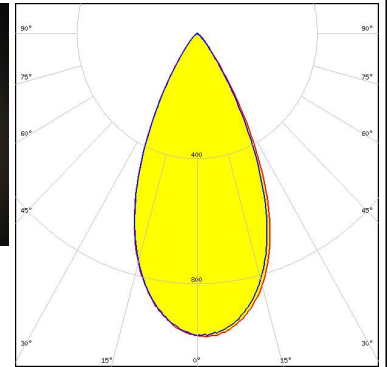

LED Fortimo SLM L09 CoB  
 FWHM / FWTM 55.0° / 79.0°  
 Efficiency 81 %  
 Peak intensity 1.1 cd/lm  
 LEDs/each optic 1  
 Light colour White  
 Required components:  
 F15858\_HEKLA-SOCKET-H

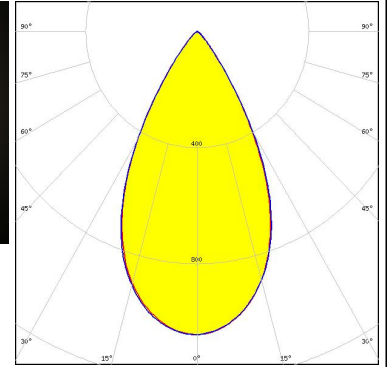

LED LC003D / LC006D / LC009D / LC013D  
 FWHM / FWTM 56.0° / 82.0°  
 Efficiency 82 %  
 Peak intensity 1 cd/lm  
 LEDs/each optic 1  
 Light colour White  
 Required components:  
 F15255\_HEKLA-SOCKET-C

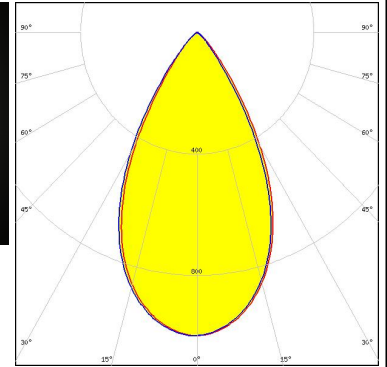
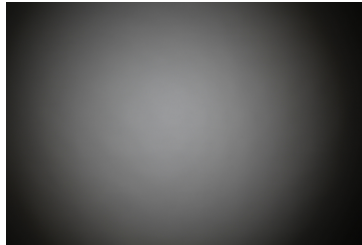

LED LC010C G2  
 FWHM / FWTM 51.0° / 74.0°  
 Efficiency 85 %  
 Peak intensity 1.2 cd/lm  
 LEDs/each optic 1  
 Light colour White  
 Required components:  
 F15255\_HEKLA-SOCKET-C

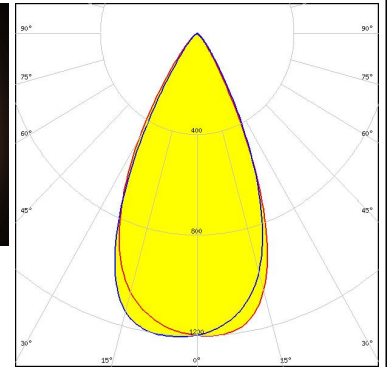
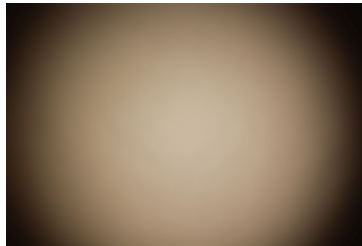

#### PHOTOMETRIC DATA (MEASURED):

### SAMSUNG

LED LC010T (Tunable White)  
 FWHM / FWTM 47.0° / 72.0°  
 Efficiency 67 %  
 Peak intensity 1.1 cd/lm  
 LEDs/each optic 1  
 Light colour Tunable White  
 Required components:  
 C16142\_HEKLA-SOCKET-K  
 Bender Wirth: 501 Typ L8

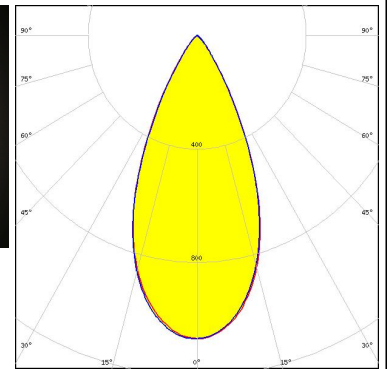

### SAMSUNG

LED LC020C G2  
 FWHM / FWTM 53.0° / 77.0°  
 Efficiency 79 %  
 Peak intensity 1.1 cd/lm  
 LEDs/each optic 1  
 Light colour White  
 Required components:  
 F15859\_HEKLA-SOCKET-I

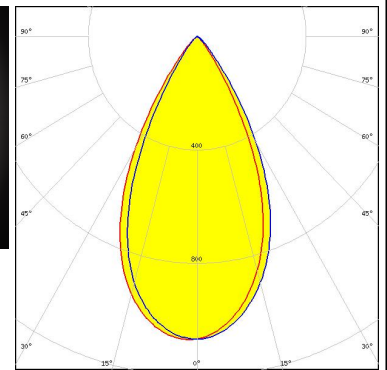

### TRIDONIC

LED SLE G7 LES09  
 FWHM / FWTM 53.0° / 79.0°  
 Efficiency 82 %  
 Peak intensity 1.1 cd/lm  
 LEDs/each optic 1  
 Light colour White  
 Required components:  
 F15255\_HEKLA-SOCKET-C

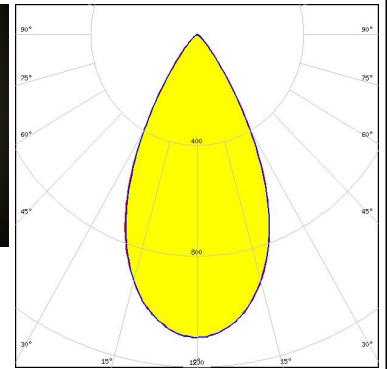
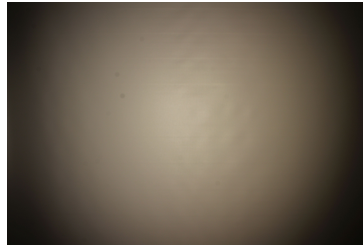

### TRIDONIC

LED SLE G7 LES13  
 FWHM / FWTM 64.0° / 87.0°  
 Efficiency 73 %  
 Peak intensity 0.7 cd/lm  
 LEDs/each optic 1  
 Light colour White  
 Required components:  
 F15859\_HEKLA-SOCKET-I

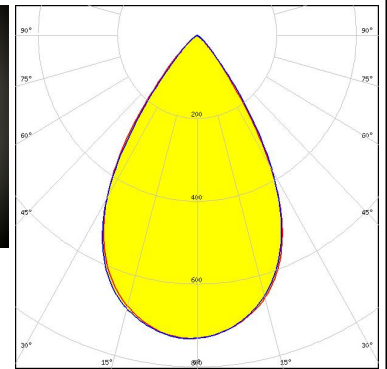
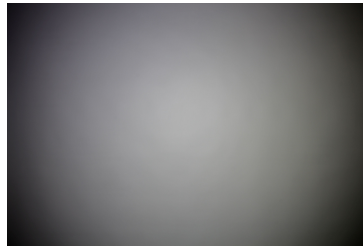

#### PHOTOMETRIC DATA (MEASURED):

#### XICATO

LED XOB 6 mm  
FWHM / FWTM 50.0° / 73.0°  
Efficiency 82 %  
Peak intensity 1.2 cd/lm  
LEDs/each optic 1  
Light colour White  
Required components:  
F15255\_HEKLA-SOCKET-C

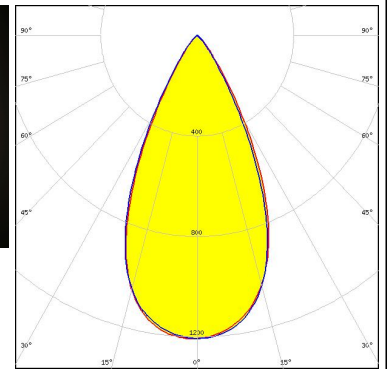

#### XICATO

LED XOB 9.8 mm  
FWHM / FWTM 54.0° / 79.0°  
Efficiency 83 %  
Peak intensity 1.1 cd/lm  
LEDs/each optic 1  
Light colour White  
Required components:  
F15255\_HEKLA-SOCKET-C

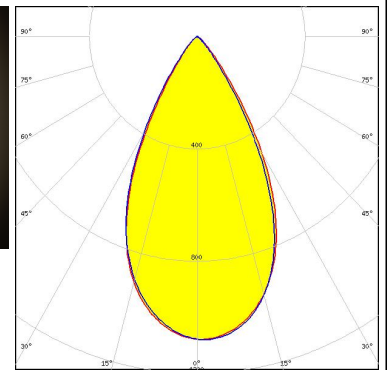

#### PHOTOMETRIC DATA (SIMULATED):

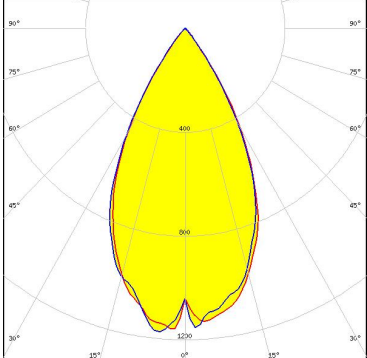
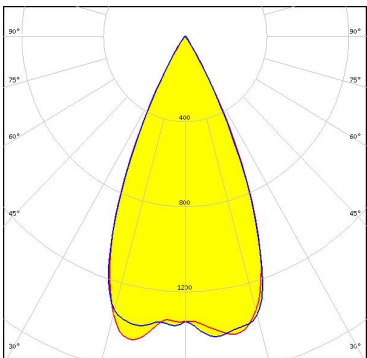
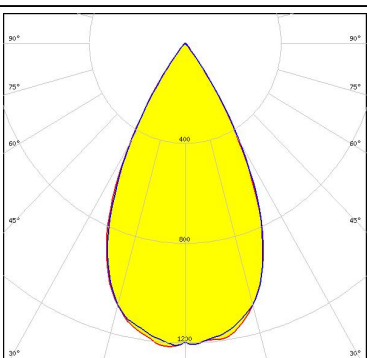
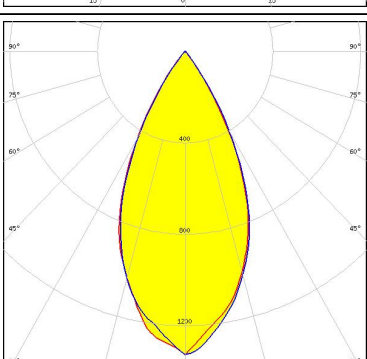
<p>bridgelux.</p> <p>LED V10 Gen7</p> <p>FWHM / FWTM 54.0° / 76.0°</p> <p>Efficiency 84 %</p> <p>Peak intensity 1.2 cd/lm</p> <p>LEDs/each optic 1</p> <p>Light colour White</p> <p>Required components: F15255_HEKLA-SOCKET-C</p>	
<p>bridgelux.</p> <p>LED V6 Gen6</p> <p>FWHM / FWTM 46.0° / 63.0°</p> <p>Efficiency 85 %</p> <p>Peak intensity 1.5 cd/lm</p> <p>LEDs/each optic 1</p> <p>Light colour White</p> <p>Required components: F15253_HEKLA-SOCKET-A</p>	
<p>bridgelux.</p> <p>LED V8 Gen7</p> <p>FWHM / FWTM 54.0° / 74.0°</p> <p>Efficiency 90 %</p> <p>Peak intensity 1.2 cd/lm</p> <p>LEDs/each optic 1</p> <p>Light colour White</p> <p>Required components: F15253_HEKLA-SOCKET-A</p>	
<p>bridgelux.</p> <p>LED VERO10</p> <p>FWHM / FWTM 49.0° / 73.0°</p> <p>Efficiency 83 %</p> <p>Peak intensity 1.3 cd/lm</p> <p>LEDs/each optic 1</p> <p>Light colour White</p> <p>Required components: F15616_HEKLA-SOCKET-F</p>	

#### PHOTOMETRIC DATA (SIMULATED):



**LED** COB L-Type (LES 11)  
**FWHM / FWTM** 65.0° / 87.0°  
**Efficiency** 84 %  
**Peak intensity** 0.8 cd/lm  
**LEDs/each optic** 1  
**Light colour** White  
**Required components:**  
 F15858\_HEKLA-SOCKET-H



**LED** COB L-Type (LES 9)  
**FWHM / FWTM** 62.0° / 81.0°  
**Efficiency** 89 %  
**Peak intensity** 1 cd/lm  
**LEDs/each optic** 1  
**Light colour** White  
**Required components:**  
 F15858\_HEKLA-SOCKET-H



**LED** COB S-Type (LES 6)  
**FWHM / FWTM** 48.0° / 67.0°  
**Efficiency** 79 %  
**Peak intensity** 1.4 cd/lm  
**LEDs/each optic** 1  
**Light colour** White  
**Required components:**  
 F15848\_HEKLA-SOCKET-G

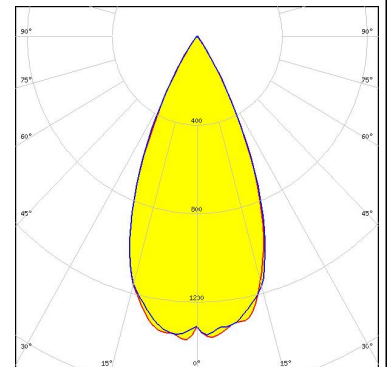

**LED** LC003D / LC006D / LC009D / LC013D  
**FWHM / FWTM** 53.0° / 75.0°  
**Efficiency** 79 %  
**Peak intensity** 1.2 cd/lm  
**LEDs/each optic** 1  
**Light colour** White  
**Required components:**  
 F17435\_HEKLA-G2-C

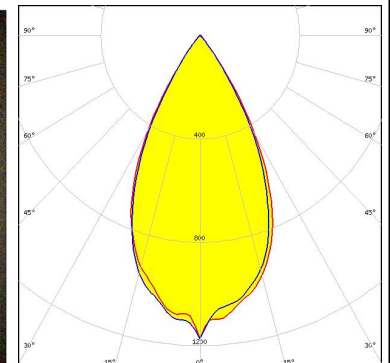
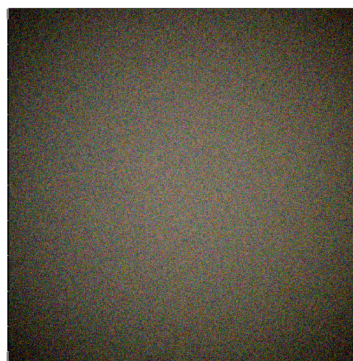

#### PHOTOMETRIC DATA (SIMULATED):

### SAMSUNG

LED LC003D / LC006D / LC009D / LC013D  
 FWHM / FWTM 52.0° / 74.0°  
 Efficiency 80 %  
 Peak intensity 1.2 cd/lm  
 LEDs/each optic 1  
 Light colour White  
 Required components:  
 F17435\_HEKLA-G2-C

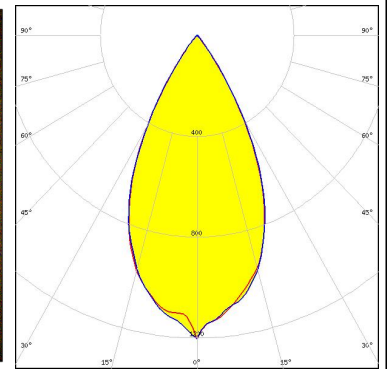

### SAMSUNG

LED LC010C  
 FWHM / FWTM 51.0° / 68.0°  
 Efficiency 84 %  
 Peak intensity 1.3 cd/lm  
 LEDs/each optic 1  
 Light colour White  
 Required components:  
 F17435\_HEKLA-G2-C

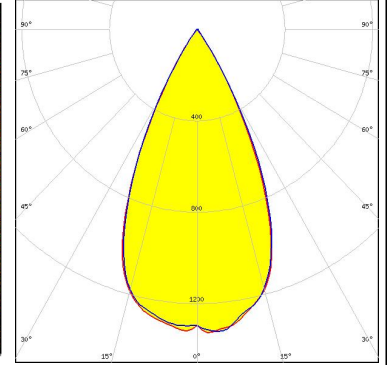

### SAMSUNG

LED LH231B  
 FWHM / FWTM 50.0° / 73.0°  
 Efficiency 82 %  
 Peak intensity 1.2 cd/lm  
 LEDs/each optic 7  
 Light colour White  
 Required components:  
 F15255\_HEKLA-SOCKET-C

### XICATO

LED XTM - 9mm LES  
 FWHM / FWTM 55.0° / 76.0 + 6.0°  
 Efficiency 87 %  
 Peak intensity 1.2 cd/lm  
 LEDs/each optic 1  
 Light colour White  
 Required components:  
 C15743\_XTM-ADAPTER-50-B

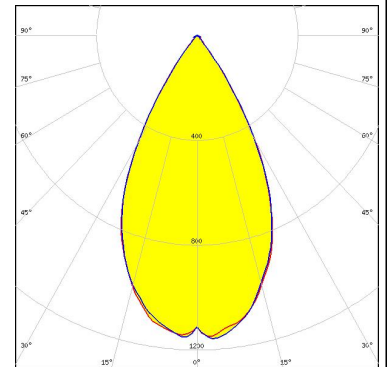



#### GENERAL INFORMATION:

NOTE: The typical beam angle will be changed by different color, chip size and chip position tolerance. The typical total beam angle is the full angle measured where the luminous intensity is half of the peak value.

Due to use of high power COB's with this product, special attention to proper thermal design is highly recommended. LEDiL has no liability for direct, indirect or consecutive damages arising from the LEDiL products being used outside of the recommended temperature range.

#### MATERIALS:

As part of our continuous research and improvement processes, and to ensure the best possible quality and availability of our products, LEDiL reserves the right to change material grades without notice.

#### PRODUCT DATA USER AGREEMENT AND DISCLAIMER:

The measured data in the provided downloadable LEDiL Product Datasheets and Mechanical 2D-Drawings is rounded and provided as reference for planning. LEDiL Oy's optical specifications have been verified by conducting performance testing of the products in accordance with the company's quality system. The reported data are averaged results of multiple measurements with typical variation. LEDiL Oy reserves the right to without prior notification make changes and improvements to its products.

LEDiL Oy assumes neither warranty, nor guarantee nor any other liability of any kind for the contents and correctness of the provided data. The provided data has been generated with highest diligence but the provided data may in reality not represent the complete possible variation range of all intrinsic parameters. Therefore, in certain cases a deviation from the provided data could occur.

LEDiL Oy reserves the right to undertake technical changes of its products without further notification which could lead to changes in the provided data. LEDiL Oy assumes no liability of any kind for the possible deviation from any provided data or any other damage resulting from the usage of the provided data.

The user agrees to this disclaimer and user agreement with the download or usage of the provided files.

#### LEDiL Oy

Joensuunkatu 13  
FI-24240 SALO  
Finland

#### LEDiL Inc.

228 West Page Street  
Suite D  
Sycamore IL 60178  
USA

#### Ledil Optics Technology (Shenzhen) Co., Ltd.

# 405 , Block B  
Casic Motor Building  
Shenzhen 518057  
P.R.CHINA

#### Local sales and technical support

[www.ledil.com/  
where\\_to\\_buy](http://www.ledil.com/where_to_buy)

#### Shipping locations

Salo, Finland  
Hong Kong, China

#### Distribution Partners

[www.ledil.com/  
where\\_to\\_buy](http://www.ledil.com/where_to_buy)