

SF2378E

925.2 MHz
SAW Filter

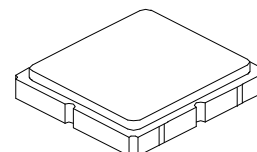

SM3030-6

- **RF Filter for Mobile Communication Applications**
- **Low Insertion Loss**
- **3.0 x 3.0 x 1.3 mm Surface-Mount Case**
- **Complies with Directive 2002/95/EC (RoHS)**
- **Moisture Sensitivity Level: 1**

Absolute Maximum Ratings

Rating	Value	Units
Maximum Incident Power in Passband	+15	dBm
Maximum DC Voltage Between any 2 Terminals	3	VDC
Operating Temperature Range	-30 to +85	°C
Storage Temperature Range	-40 to +85	°C
Terminating Source Impedance (single) Z_S	50	Ω
Terminating Load Impedance (single) Z_L	50	Ω
Maximum Soldering Profile	260 °C for 10 s	

Characteristic	Sym	Notes	Min	Typ	Max	Units
Center Frequency	f_C			925.2		MHz
Minimum Insertion Loss, 922.3 - 928.1 MHz	IL			2.5	3.5	dB
Amplitude Ripple, 922.3 - 928.1 MHz				0.6	1.5	dB
VSWR						
Input (922.3 - 928.1 MHz)				1.4	2.0	
Output (922.3 - 928.1 MHz)				1.4	2.0	
Attenuation Referenced to 0 dB:						
10 to 815 MHz			42	45		dB
815 to 875 MHz			40	45		
875 to 905 MHz			35	40		
905 to 915 MHz			11	15		
945 to 950 MHz			35	40		
950 to 1150 MHz			50	55		
1150 to 1856 MHz			32	35		
1856 to 2500 MHz			32	35		

Case Style	SM3030-6 3 x 3 mm Nominal Footprint
Lid Symbolization (Y=year, WW=week, S=shift)	6F <u>Y</u> <u>WW</u> <u>S</u>

 **CAUTION: Electrostatic Sensitive Device. Observe precautions for handling.**

NOTES:

1. The design, manufacturing process, and specifications of this device are subject to change.
2. US or International patents may apply.
3. RoHS compliant from the first date of manufacture.

Electrical Connections

Connection	Terminals
Input	2
Output	5
Ground	All others

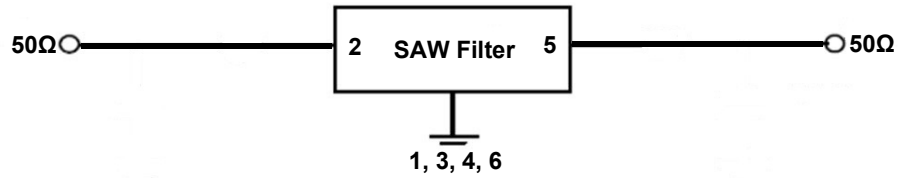

Frequency Characteristics

S21 Response: Span 200 MHz

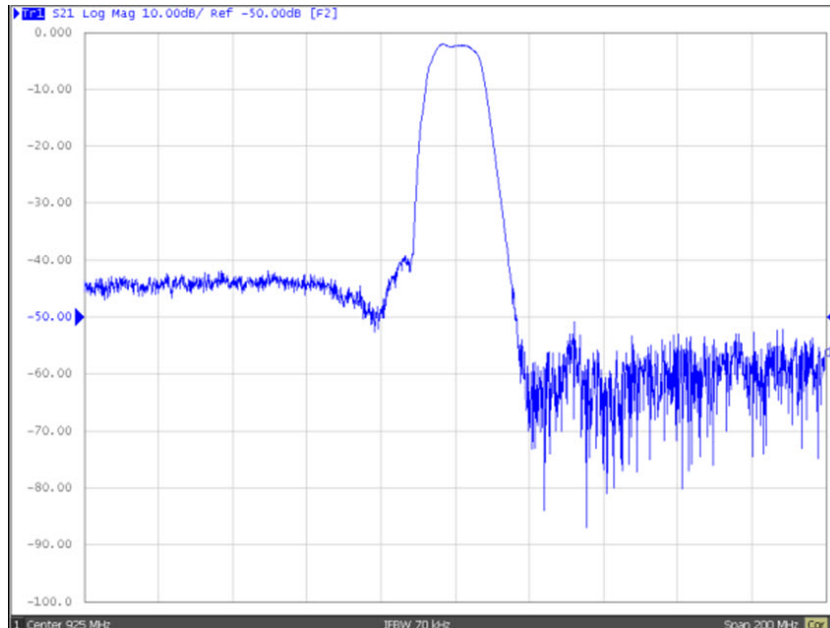

S21 Response: Span 5 MHz

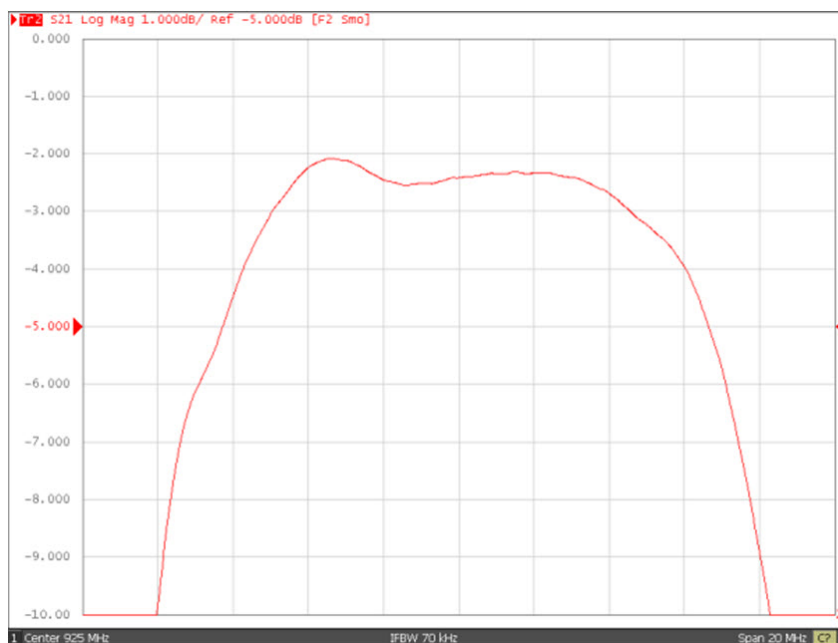

S21 Response: Span 5 MHz

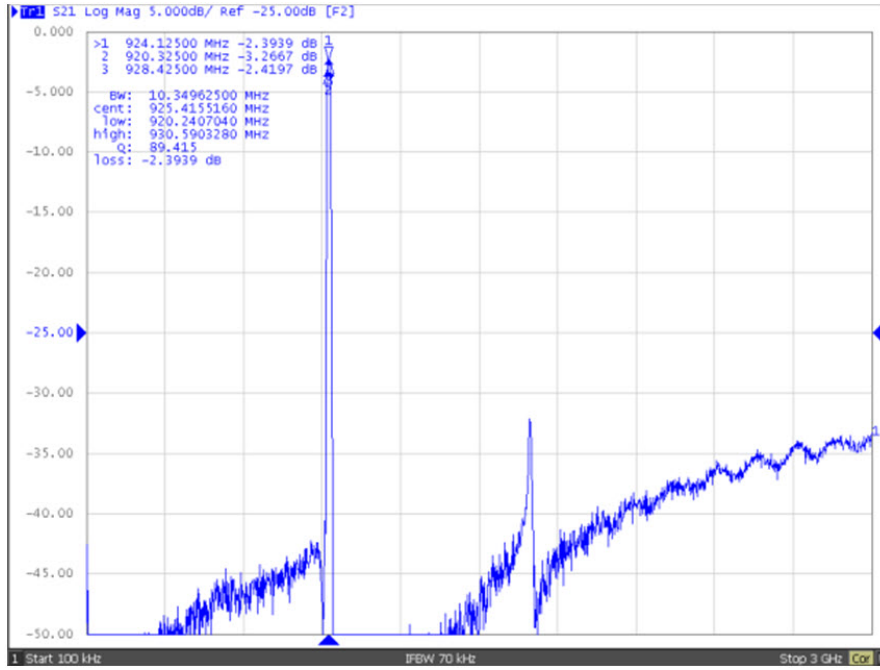

S21 Response: Span 5 MHz

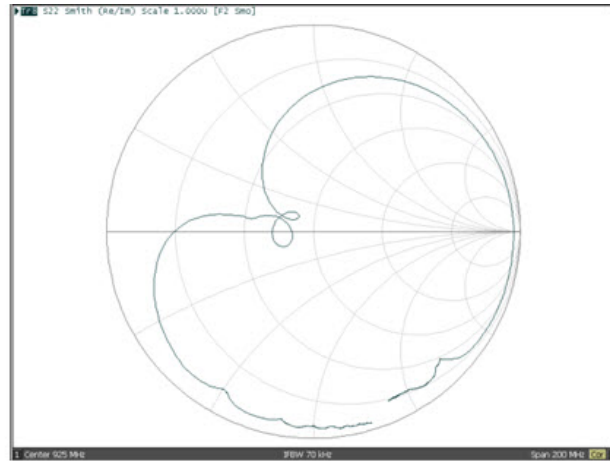
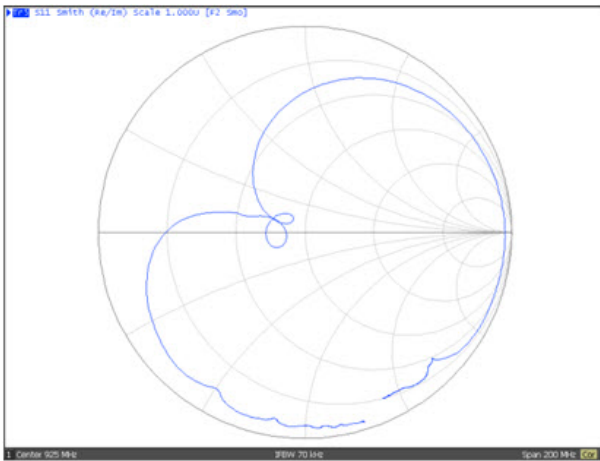

SM3030-6 Case

6-Terminal Ceramic Surface-Mount Case 3.0 X 3.0 mm Nominal Footprint

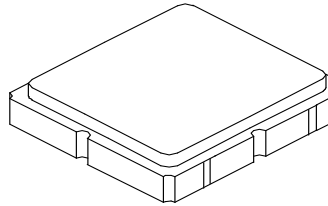

PCB Footprint, Top View

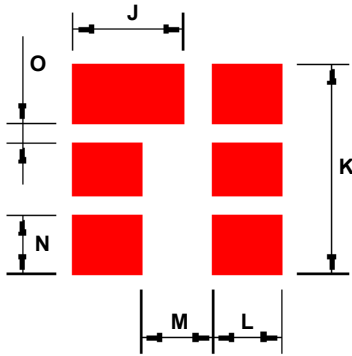

Case Dimensions

Dimension	mm			Inches		
	Min	Nom	Max	Min	Nom	Max
A	2.85	3.0	3.15-	0.151	0.118	0.124
B	2.85	3.0	3.15-	0.151	0.118	0.124
C	-	-	1.4	-	-	0.055
D	0.55	0.60	0.65	0.021	0.023	0.025
E	-	0.45	-	-	0.110	-
F	-	0.15	-	-	0.063	-
G	1.05	1.20	1.35	0.041	0.047	0.053
H	0.38	0.53	0.68	0.014	0.020	0.026
I	0.60	0.75	0.90	0.023	0.029	0.035
J	-	1.70	-	-	0.066	-
K	-	3.20	-	-	0.125	-
L	-	1.05	-	-	0.041	-
M	-	1.10	-	-	0.043	-
N	-	0.90	-	-	0.035	-
O	-	0.30	-	-	0.011	-

TOP VIEW

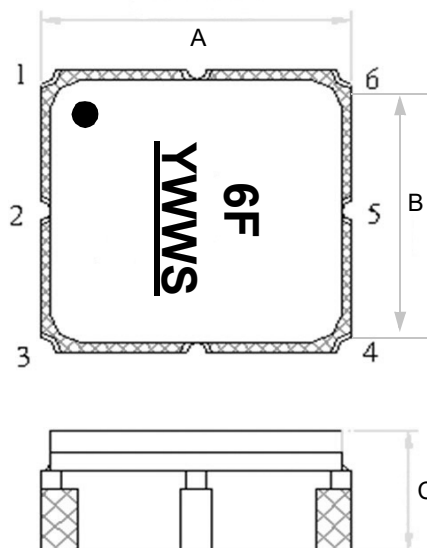

BOTTOM VIEW

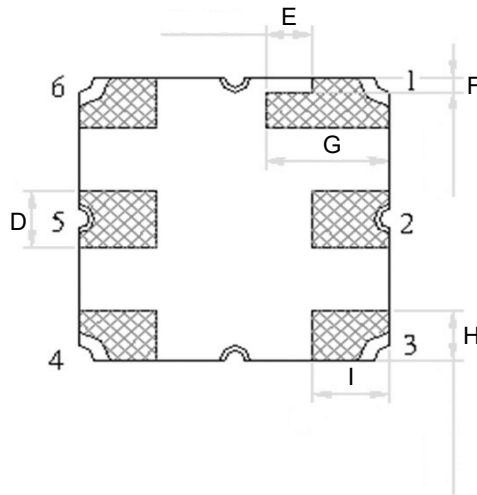

Tape and Reel Specifications

Tape and Reel Standard per ANSI/EIA-481

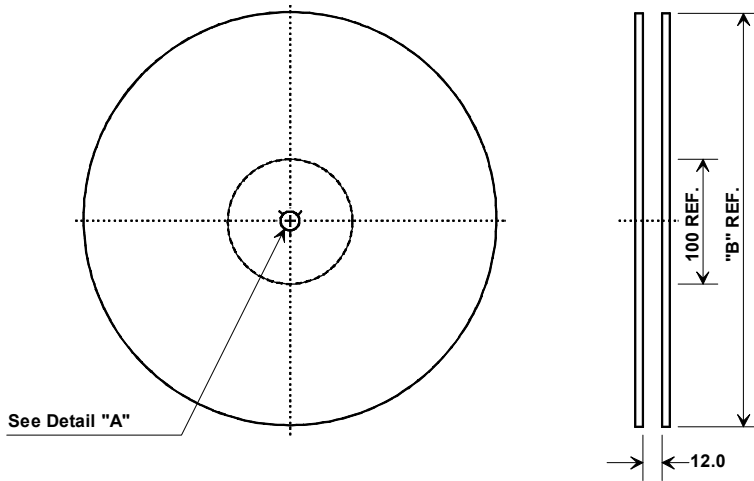

"B"		Quantity Per Reel
Nominal Size		
Inches	millimeters	
7	178	500
13	330	3000

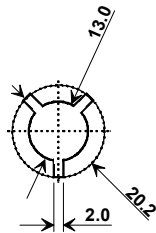

COMPONENT ORIENTATION and DIMENSIONS

Carrier Tape Dimensions	
Ao	4.25 mm
Bo	4.25 mm
Ko	1.3 mm
Pitch	8.0 mm
W	12.0 mm

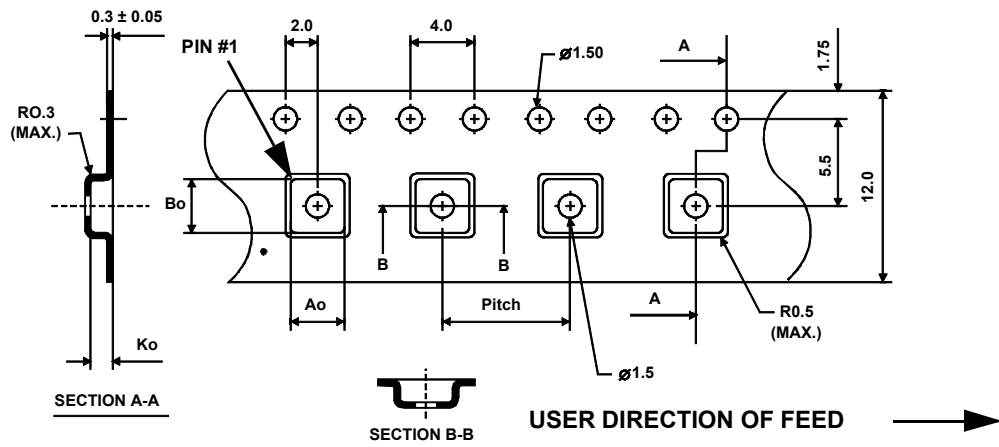

Recommended Reflow Profile

1. Preheating shall be fixed at 150~180°C for 60~90 seconds.
2. Ascending time to preheating temperature 150°C shall be 30 seconds min.
3. Heating shall be fixed at 220°C for 50~80 seconds and at 260°C +0/-5°C peak (10 seconds).
4. Time: 5 times maximum.

