



BeStar Technologies Inc.

Address: 761 N. 17th Street Unit 4, St. Charles, IL 60174

Tel : 847-261-2850 E-mail : sales@bestartech.com Web : www.bestartech.com

Document Number : 1610-65
Revision : A2
Total Pages : 6
Prepare by : Hermes, **Shum**
Date : 28 November, 2019

SENER Brand Power Product

www.jlsener.com

Document Type : Specification
Product Type : Lithium Fluorocarbons Coin Cell
Ordering Code : SBR2450
Cell Part Number : BR2450

A1 - New issue created by Hermes, Shum on 22 Nov., 2019		
A2 - Updated sections 2 ~ 6 by Hermes, Shum on 28 Nov., 2019		

This material is the property of BeStar Technologies Inc.
Unauthorized copying or use of this material is prohibited.

1. Purpose and Scope

This document contains both general requirements, qualification requirements, and those specific electrical, mechanical requirements for this part.

2. Description

Ø24mm Lithium Fluorocarbons coin cell, RoHS compliant.

3. Application

Computers and Peripherals, Portable Equipment, etc.

4. Component Requirement

4.1. General Requirement

4.1.1.	Operating Temperature Range	: -40°C to +85°C
4.1.2.	Storage Temperature Range	: 0°C to +30°C
4.1.3.	Storage Humidity	: 40 ~ 75%
4.1.4.	Weight	: Approx. 6.9g
4.1.5.	Materials of Positive Terminal	: SUS Stainless
4.1.6.	Materials of Negative Terminal	: SUS Stainless

4.2. Electrical Requirement

4.2.1.	Nominal Voltage	: 3V
4.2.2.	Nominal Capacity (under Load 7.5kΩ Load and 2.0V End-voltage)	: 550mAh
4.2.3.	Standard Discharge Current	: 0.4mA

4.3. Standard Characteristics

4.3.1. Discharge Characteristics (End Voltage: 2V, Temperature: 23°C)

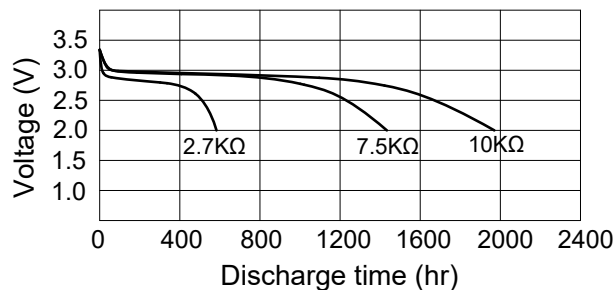

Figure 1. Discharge Characteristics

4.3.2. Load-Capacity (End Voltage: 2V)

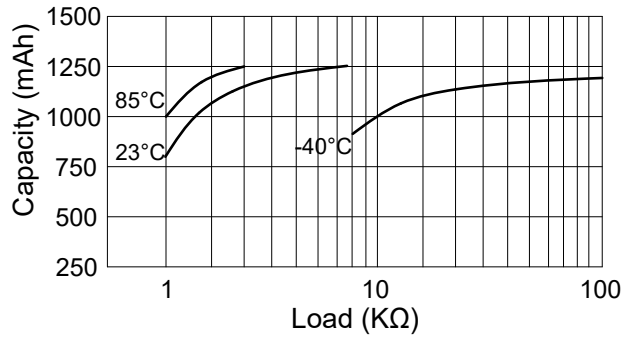

Figure 2. Load-Capacity

4.3.3. Pulse Discharge Characteristics (Discharge depth 40%, pulse load for 15 sec)

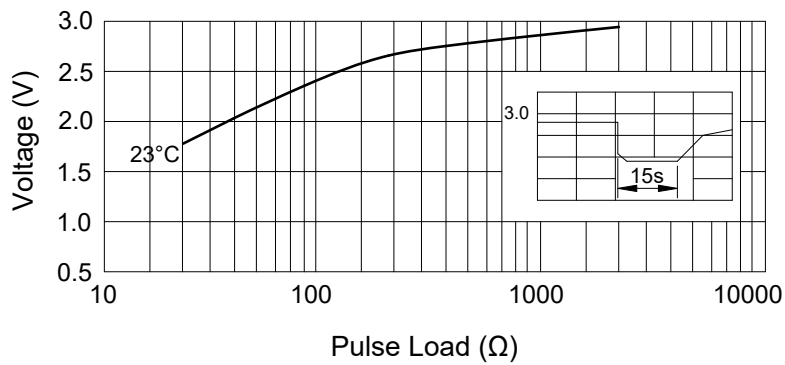

Figure 3. Pules Discharge Characteristics

4.3.4. Temperature Characteristics (End Voltage: 2V, Load: 15KΩ)

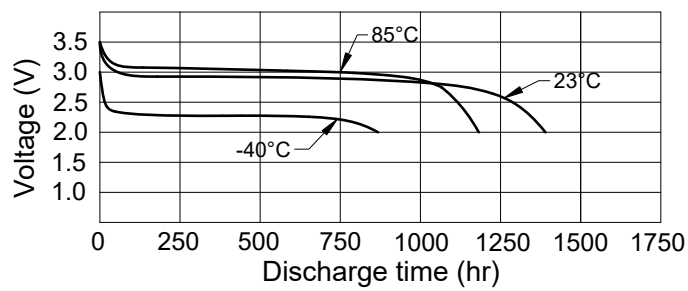

Figure 4. Temperature Characteristics

4.3.5. Load-Operating voltage (Discharge depth: 40%)

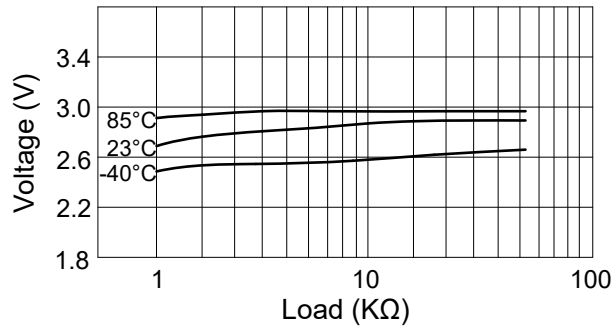

Figure 5. Load-Operating voltage

4.3.6. Storage Characteristics (End Voltage: 2V, Temperature: 23°C, Load: 7.5KΩ)
(Storage at 60°C after 30 days equivalent to storage at room temperature for 18 months)

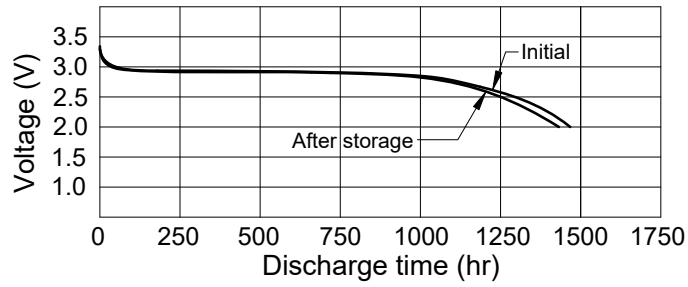

Figure 6. Storage Characteristics

5. Reliability Test

- 5.1. Open-circuit Voltage** : Subject samples to $+20 \pm 2$ °C for 8 hours or longer. Then measure the voltage between both terminals at the same ambient temperature with DC voltmeter.
- 5.2. Closed-circuit Voltage** : Subject samples to $+20 \pm 2$ °C for 8 hours or longer. Then measure the voltage between both terminals at the same ambient temperature with DC voltmeter. Measured value shall be based on meter reading taken 0.8 seconds after the circuit is closed.
- 5.3. Service Life** : Subject samples to 20 ± 2 °C for 8 hours or longer. Then continuously discharge at the same ambient temperature and through 7.5k Ω . Discharge until terminal voltage of the test specimens falls below the discharge end-point voltage of 2.0V, and the time during which the terminal voltage is equal to and above the discharge end-point voltage shall be taken as the service life.
- 5.4. Service Life after High Temperature Storage** : Store samples at $+60 \pm 2$ °C for 20 days. Then subject samples to $+20 \pm 2$ °C and ordinary humidity 55% \pm 20% for 12 hours or longer and continuously discharge through 7.5K Ω . Discharge until the voltage falls below the discharge end-point voltage of 2.0V, and the time during which the voltage is equal to and above the discharge end-point voltage shall be taken as the service life.
- 5.5. Electrolyte Leakage Test** : Samples shall be examined for electrolyte leakage while they are kept at ordinary temperature and ordinary humidity after being stored at 45 ± 2 °C and 75% relative humidity for 30 days.
- 5.6. Self-discharge** : Store samples for 12 months at $+20 \pm 2$ °C and 55% \pm 20% relative humidity and tested for service life in accordance with the method specified in 5.3. Self-discharge shall be determined as follows:

$$\text{Self-discharge rate (\%)} = (Y1-Y2)/Y1 \times 100\%$$

Y1 : Average initial discharge life of batteries of the same lot

Y2 : Average discharge life after storage

6. Mechanical Layout

Unit : mm

Tolerance : Linear XX.X = ±0.3
 XX.XX = ±0.05
 Angular = ±0.25°

(unless otherwise specified)

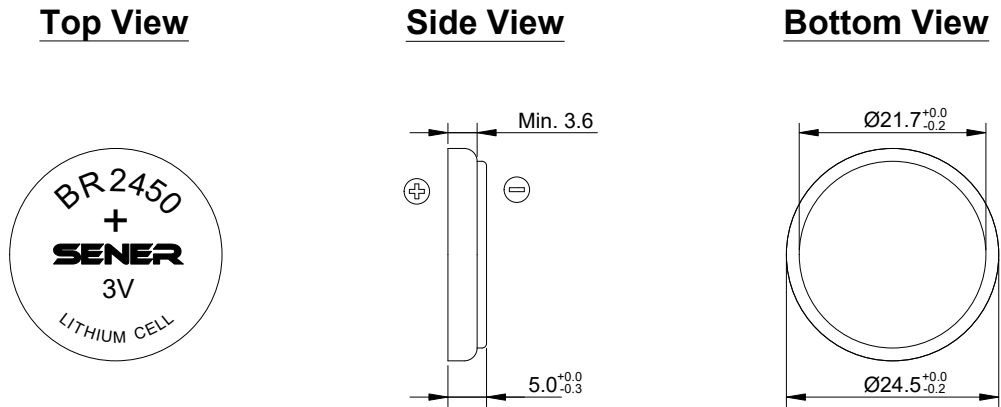

Figure 7. SBR2450 Mechanical Layout