

MAX15104

Small 2A, Low-Dropout Linear Regulator in a 2.7mm x 1.6mm Package

General Description

The MAX15104 is a small, low-dropout linear regulator optimized for networking, datacom, and server applications. The regulator delivers up to 2A from a 1.7V to 5.5V input supply with output accuracy of $\pm 1.6\%$. The output is adjustable down to 0.6V with a guaranteed dropout voltage of less than 150mV at full load. The internal p-channel switch is protected with a foldback current limit and thermal shutdown.

The MAX15104 features an external bypass input to reduce noise. This bypass input also serves as a soft-start control. An enable input and power-good output are included for power sequence control.

The MAX15104 is available in a 1.6mm x 2.7mm WLP package and is fully specified from the -40°C to $+85^{\circ}\text{C}$ operating temperature range.

Features

- 1.7V to 5.5V Operating Range
- 150mV Dropout Guaranteed at 2A
- $\pm 1.6\%$ Output Accuracy Over Line, Load, and Temperature
- 70dB PSRR At 500kHz
- Adjustable Output from 0.6V to 5.2V
- Foldback Current Protection
- Thermal Shutdown Protection
- Low Noise $15\mu\text{V}_{\text{RMS}}$ (typ)
- Small 1.6mm x 2.7mm WLP Package

Ordering Information appears at end of data sheet.

Applications

- Networking
- Telecom/Datacom
- Servers
- Base Stations
- PLL Power

Typical Operating Circuit

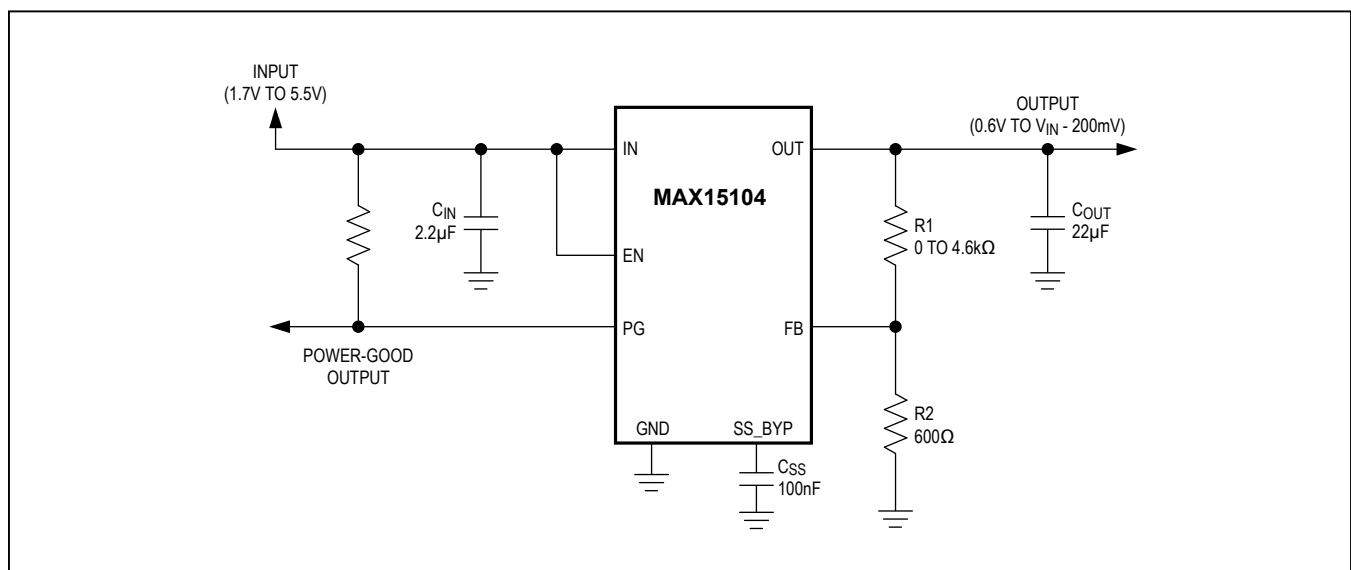

Absolute Maximum Ratings

IN, SS_BYP, FB to GND	-0.3V to +6V	Operating Temperature Range.....	-40°C to +85°C
EN, PG, OUT to GND	-0.3V to (V _{IN} + 0.3V)	Storage Temperature Range.....	-65°C to +150°C
OUT Short Circuit	Continuous	Junction Temperature.....	+150°C
Continuous Power Dissipation (T _A = +70°C)		Soldering Temperature (reflow) (Note 1).....	+260°C
WLP (derate 19.2mW/°C above +70°C).....	1538mW		

Stresses beyond those listed under "Absolute Maximum Ratings" may cause permanent damage to the device. These are stress ratings only, and functional operation of the device at these or any other conditions beyond those indicated in the operational sections of the specifications is not implied. Exposure to absolute maximum rating conditions for extended periods may affect device reliability.

Note 1: The WLP package is constructed using a unique set of package techniques that impose a limit on the thermal profile. The device can be exposed during board-level solder attach and rework. This limit permits only the use of the solder profiles recommended in the industry-standard specification JEDEC 020A, paragraph 7.6, Table 3 for IR/VPR and convection reflow. Preheating is required. Hand or wave soldering is not allowed.

Package Thermal Characteristics (Note 2)

WLP
Junction-to-Ambient Thermal Resistance (θ_{JA})30°C/W

Note 2: Package thermal resistances were obtained using the method described in JEDEC specification JESD51-7, using a four-layer board. For detailed information on package thermal considerations, refer to www.maximintegrated.com/thermal-tutorial.

Electrical Characteristics

(V_{IN} = 3.3V, V_{OUT} = 1.5V, V_{EN} = V_{IN}, I_{OUT} = 100mA, C_{IN} = 2.2µF, C_{OUT} = 22µF, T_A = T_J = -40°C to +85°C, typical values are at T_A = +25°C, unless otherwise noted.) (Note 3)

PARAMETER	SYMBOL	CONDITIONS	MIN	TYP	MAX	UNITS
IN						
Input Voltage Range	V _{IN}		1.7		5.5	V
Input Undervoltage Lockout	V _{IN_UV}	V _{IN} rising		2.03	2.099	V
Input Undervoltage Lockout Hysteresis	V _{IN_UV_HYS}			70		mV
OUT						
Output Voltage Range	V _{OUT}		0.6		5.2	V
Load Regulation		I _{OUT} = 30mA to 2A		0.1		%/A
Line Regulation		V _{IN} = 1.7V to 5.5V, V _{OUT} = 0.6V, I _{OUT} = 190mA	-0.15		+0.15	%/V
Dropout Voltage		I _{OUT} = 2A, V _{FB} = 580mV (Note 4)		50	150	mV
In-Regulation Current Limit		V _{IN} = 5.5V, V _{FB} = 500mV		2.5		A
Short-Circuit Foldback Current Limit		V _{IN} = 5.5V, V _{OUT} = 0V, V _{FB} < 100mV		1.4		A
Output Shutdown Leakage		V _{IN} = 5.5V, V _{OUT} = 0V, V _{EN} = 0V			5	µA
Line Transient		ΔV _{IN} = 0.5V, t _{RISE} = t _{FALL} = 5µs		2		%

Electrical Characteristics (continued)

($V_{IN} = 3.3V$, $V_{OUT} = 1.5V$, $V_{EN} = V_{IN}$, $I_{OUT} = 100mA$, $C_{IN} = 2.2\mu F$, $C_{OUT} = 22\mu F$, $T_A = T_J = -40^\circ C$ to $+85^\circ C$, typical values are at $T_A = +25^\circ C$, unless otherwise noted.) (Note 3)

PARAMETER	SYMBOL	CONDITIONS	MIN	TYP	MAX	UNITS	
Load Transient		$I_{OUT} = 100mA$ to $1A$ to $100mA$, $t_{RISE} = t_{FALL} = 1\mu s$		1.3		%	
Power-Supply Rejection		Frequency = $500kHz$, $I_{OUT} = 500mA$		70		dB	
Output Voltage Noise		Frequency = $500Hz$ to $100kHz$, $I_{OUT} = 100mA$		15		μV_{RMS}	
FB							
FB Threshold Accuracy		$I_{OUT} = 190mA$, $V_{OUT} = 1.5V$ to $5V$, $V_{IN} = (V_{OUT} + 0.3V)$ to $5.5V$	593	600	606	mV	
		$I_{OUT} = 3mA$ to $2A$, $V_{OUT} = 1.5V$ to $5V$, $V_{IN} = (V_{OUT} + 0.3V)$ to $5.5V$	590		610		
FB Input Current		$V_{FB} = 0.6V$, $V_{IN} = 5.5V$			1	μA	
GND							
Ground Supply Current				1.8	3.5	mA	
Ground Shutdown Current		$V_{IN} = 1.7V$ to $5.5V$			1	μA	
POWER-GOOD OUTPUT							
Power-Good (PG) Threshold		V_{FB} moving out of regulation, $V_{HYS} = 15mV$	FB = high	638	650	662	mV
			FB = low	538	550	562	
Power-Good (PG) Output-Voltage Low		$I_{PG} = 2mA$ (sink)		25	80	mV	
Power-Good (PG) Delay				100		μs	
Power-Good (PG) Leakage		$V_{PG} = 5.5V$			1	μA	
ENABLE							
Enable Input High Threshold	V_{EN_HIGH}		1.2			V	
Enable Input Low Threshold	V_{EN_LOW}				0.4	V	
Enable Input Bias Current		$V_{EN} = 0$ to $5.5V$	-1		+1	μA	
SOFT-START							
Soft-Start Charging Current		$V_{SS_BYP} = 100mV$	8	9.2	12	μA	
Soft-Start Pulldown Resistance		$V_{EN} = 0V$, $I_{SS_BYP} = 2mA$		45	100	Ω	
THERMAL SHUTDOWN							
Thermal Shutdown Threshold				+160		$^\circ C$	
Thermal Shutdown Hysteresis		Threshold falling		15		$^\circ C$	

Note 3: All devices 100% production tested at $T_A = +25^\circ C$. Limits over the temperature range are guaranteed by design.

Note 4: Dropout is defined as $V_{IN} - V_{OUT}$ when V_{OUT} falls 3% below its nominal voltage value.

Typical Operating Characteristics

($V_{IN} = 1.8V$, $V_{OUT} = 1.5V$, $T_A = +25^\circ C$, unless otherwise noted.)

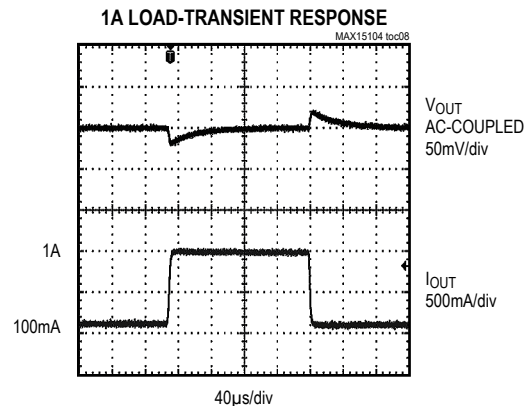
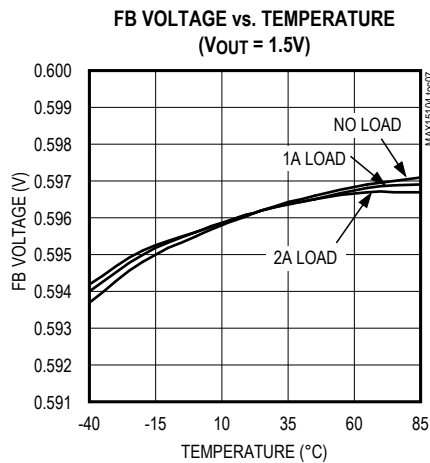
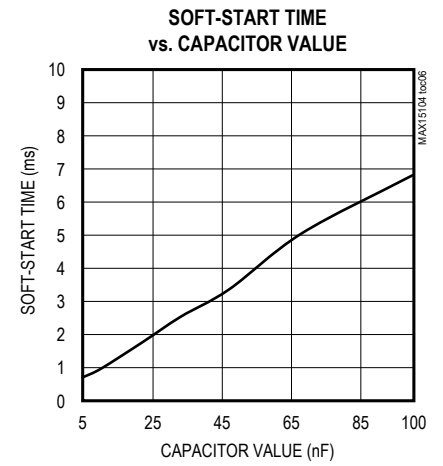
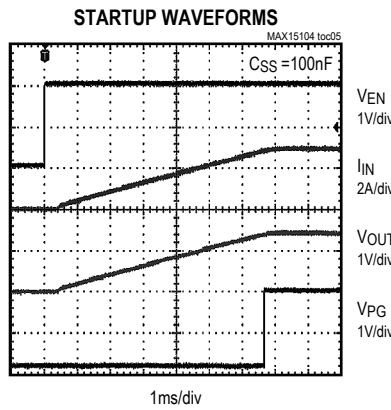
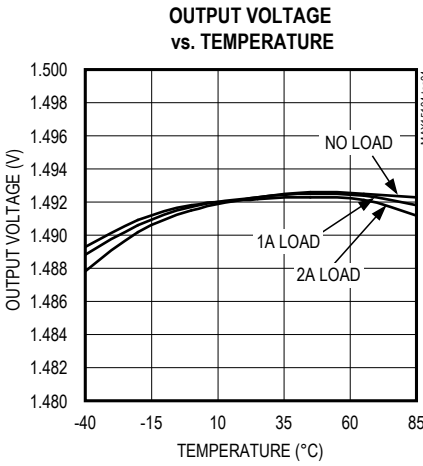
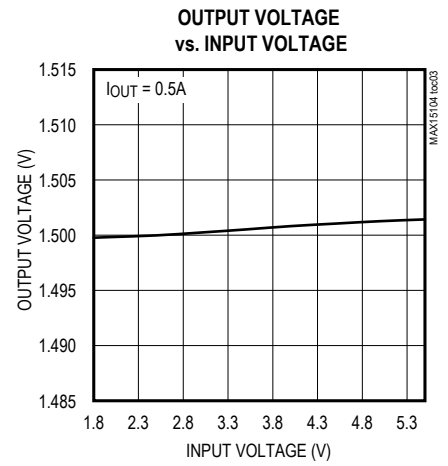
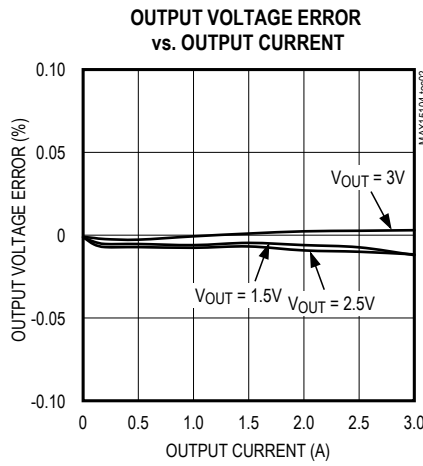
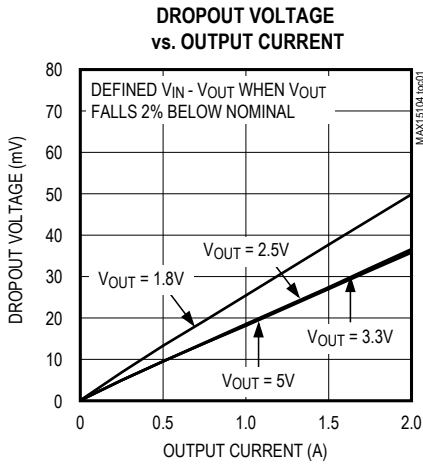

Typical Operating Characteristics (continued)

($V_{IN} = 1.8V$, $V_{OUT} = 1.5V$, $T_A = +25^\circ C$, unless otherwise noted.)

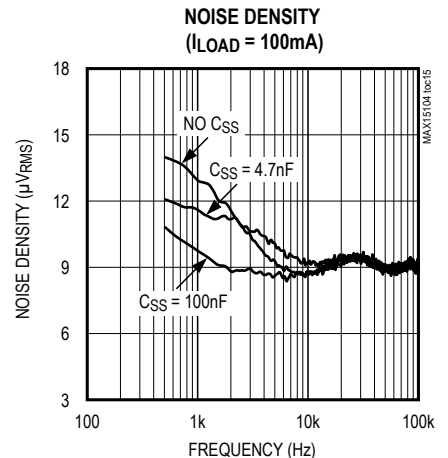
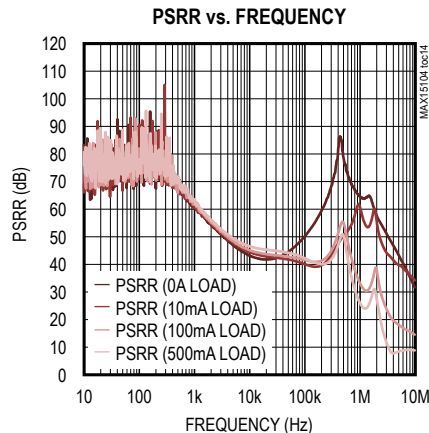
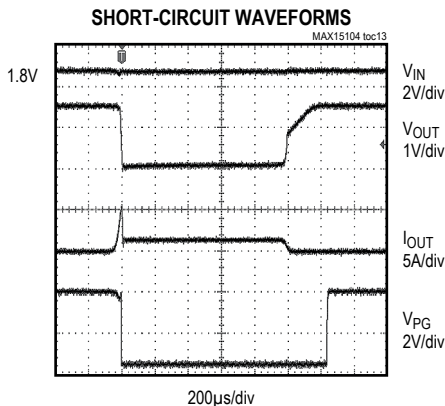
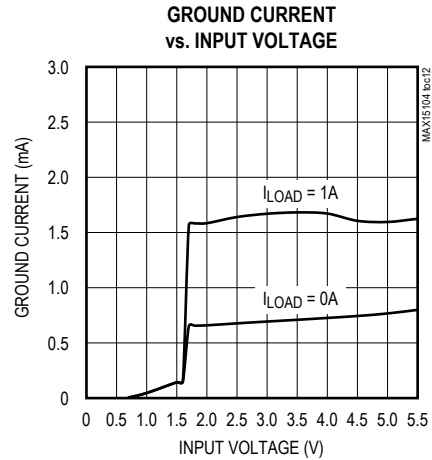
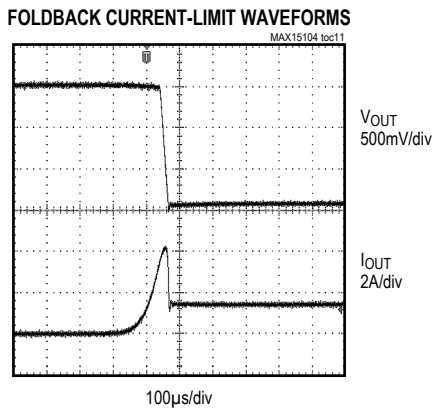
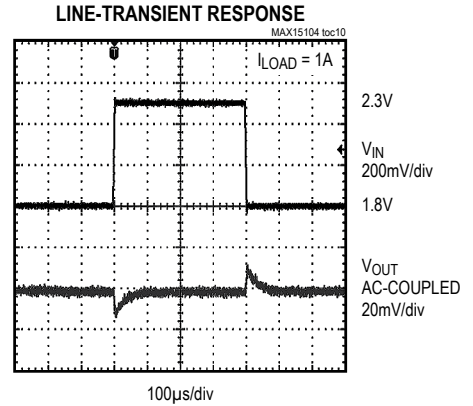
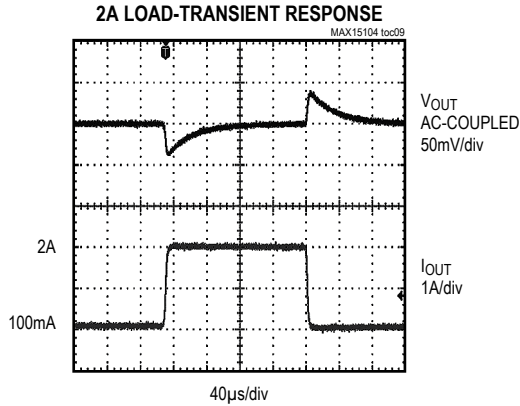

Bump Configuration

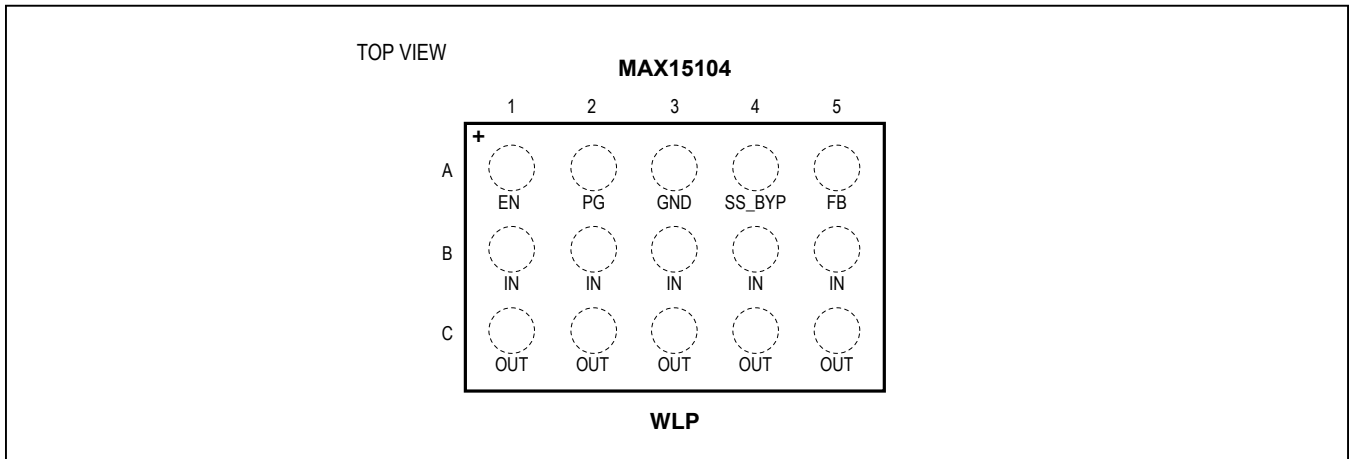

Bump Description

BUMP	NAME	FUNCTION
A1	EN	Active-High Enable Input. Drive EN logic-high to enable the LDO. Connect to IN for always-on operation.
A2	PG	Power-Good Output. Open-drain output asserts high when the voltage is within regulation.
A3	GND	Ground
A4	SS_BYP	SS_BYP Bypass/Soft-Start Input. Connect a ceramic capacitor from SS_BYP to GND to reduce the output noise and set the soft-start ramp time.
A5	FB	Feedback Input. Connect a resistive divider from OUT to GND to set the output voltage.
B1, B2, B3, B4, B5	IN	Supply Voltage Input. Connect to supply voltage from 1.7V to 5.5V. Bypass IN to GND with a 2.2μF or greater ceramic capacitor.
C1, C2, C3, C4, C5	OUT	Regulated Output. Connect a 22μF capacitor from OUT to GND. For better load transient performance a larger capacitor can be used.

Functional Diagram

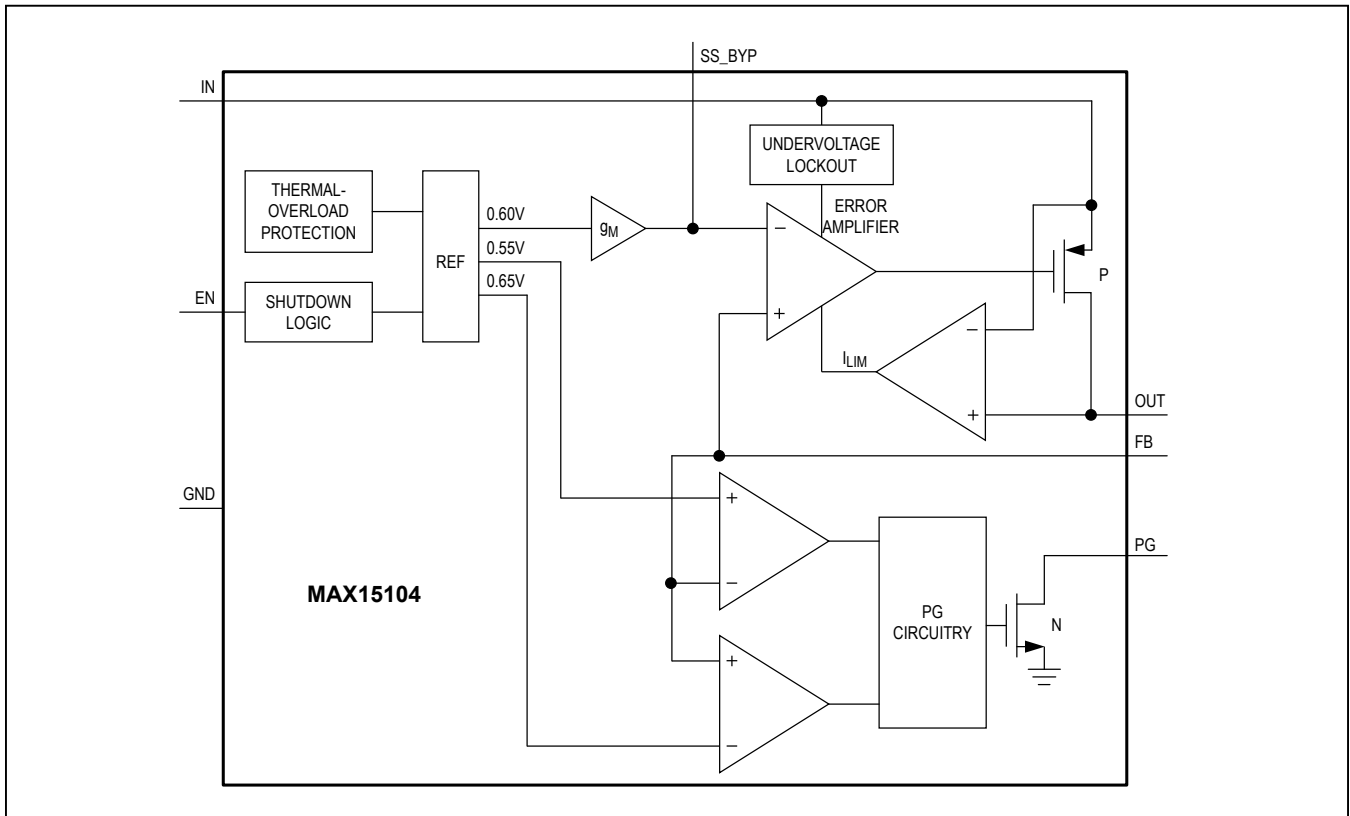

Detailed Description

The MAX15104 is a small, low-dropout linear regulator optimized for server, network, and telecom applications. The regulator delivers up to 3A from a 1.7V to 5.5V input supply with output accuracy of ±1.6%. The output is adjustable down to 0.6V with a guaranteed dropout voltage of less than 150mV at full load. The internal p-channel switch is protected with a foldback current limit and thermal shutdown.

The MAX15104 features an external bypass input to reduce noise. This bypass input also serves as a soft-start control. An enable input and power-good output are included for power sequence control.

Internal p-Channel Pass Transistor

The MAX15104 features a 2A p-channel MOSFET pass transistor. Unlike similar designs with pnp pass transistors, the gate-drive current to the p-channel power

transistor is extremely low. PNP-based regulators also waste considerable current in dropout when the pass transistor saturates and uses high base-drive currents under large loads. The MAX15104 does not suffer from these deficiencies and consumes only 1.8mA of quiescent current even in dropout.

Output Voltage Selection

The MAX15104 features an adjustable output. The output voltage can be set between +0.6V to $V_{IN} - 200mV$ using an external resistive voltage-divider to FB (see the [Typical Operating Circuit](#)). The output voltage is set using the following equation:

$$V_{OUT} = V_{FB} (1 + R1/R2)$$

where $V_{FB} = +600mV$.

To simplify resistor selection:

$$R1 = R2 (V_{OUT}/V_{FB} - 1)$$

Set R2 to 600Ω.

Enable

A logic-low on EN disables the MAX15104. In shutdown, the pass transistor, control circuitry, reference, and all biases are turned off, reducing supply current to typically 1µA. Connect EN to IN for normal operation. In shutdown, the soft-start capacitor is discharged using an internal pulldown resistance.

Soft-Start

As shown in the [Typical Operating Circuit](#), the MAX15104 uses a gm stage and integrating capacitor C_{SS} to control the regulator’s feedback set point. When EN is driven low, the soft-start capacitor is discharged. When EN is driven high or power is applied to the device, a constant 9.2µA current charges the soft-start capacitor. At startup, the feedback set point increases linearly, which reduces the inrush supply current.

$$t_{SS} = 6.315 \times 10^{-5} \times C_{SS}$$

where C_{SS} is in nF. Use capacitor values between 30nF to 100nF with voltage ratings greater than 5V.

Because this ramp is applied to the current-limit comparator, the actual time for the output voltage to ramp up depends on the load current and output capacitor. Leave SS_BYP unconnected to disable soft-start.

Foldback Current Limiting

The MAX15104 features a 2.5A current limit when the output voltage is in regulation. When the voltage at the output drops to 17% of its nominal value, the current limit exponentially folds back to 1.4A. The output can be shorted to ground for an indefinite period of time without damaging the device. Avoid continuous output current of greater than 2A to prevent damage to the regulator.

Thermal-Overload Protection

A thermal-overload circuit limits total power dissipation in the MAX15104. When the junction temperature exceeds T_J = +160°C, the thermal sensor turns off the pass transistor, allowing the IC to cool. The thermal sensor turns the pass transistor on once the IC’s junction temperature drops approximately 15°C. Continuous short-circuit conditions will consequently result in a foldback limited output.

Thermal-overload protection is designed to safeguard the MAX15104 in the event of fault conditions. For continuous operation, do not exceed the junction temperature rating of T_J = +125°C.

Operating Region and Power Dissipation

The power dissipation across the device is P = I_{OUT}(V_{IN} - V_{OUT}). The resulting maximum power dissipation is:

$$P_{MAX} = [(T_{J(MAX)} - T_A)/(\theta_{JA})]$$

where (T_{J(MAX)} - T_A) is the temperature difference between the maximum allowed die junction (+150°C) and the surrounding air. [Figure 1](#) shows the allowable power dissipation for typical PCBs at +25°C, +50°C, and +70°C ambient temperatures (refer to the MAX15104 EV kit).

Applications Information

Capacitor Selection and Regulator Stability

Capacitors are required at the MAX15104’s input and output. Connect at least a 2.2µF capacitor between IN and GND (C_{IN}) and a 22µF capacitor between OUT and GND (C_{OUT}). 10µF can be used for lower current operation (1A for example). Use only surface-mount ceramic capacitors that have low equivalent series resistance (ESR). Make the input and output traces at least 2.5mm wide, and connect C_{IN} and C_{OUT} within 6mm of the IC to minimize the impact of PCB trace inductance.

The output capacitor’s ESR can affect stability and output noise. Use capacitors with 50mΩ or less ESR to ensure stability and optimum transient response. This is particularly true in applications with very low output voltage (< 2V) and high output current (> 0.5A).

Since some capacitor dielectrics can vary over bias voltage and temperature, consult the capacitor manufacturer specifications to ensure that the capacitors meet these requirements over all combinations of operating voltage and temperature.

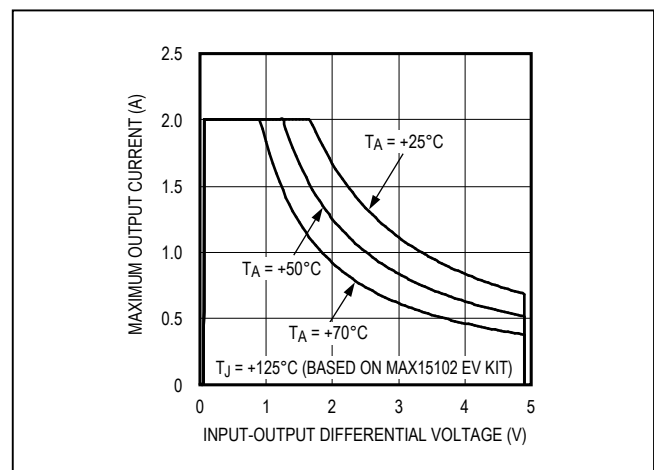

Figure 1. Maximum Output Current Curves

MAX15104

Small 2A, Low-Dropout Linear Regulator in a 2.7mm x 1.6mm Package

Input-Output (Dropout) Voltage

A regulator's minimum input-to-output voltage differential (dropout voltage) determines the lowest usable supply voltage. The dropout voltage is simply the product of regulator's $R_{DS(ON)}$ for the pass device and rated load current. The MAX15104's $R_{DS(ON)}$ is 25m Ω , at 2A this yields a dropout voltage of 50mV (see the [Electrical Characteristics](#) and the Dropout Voltage vs. Output Current graph in the [Typical Operating Characteristics](#)).

Noise, PSRR, and Transient Response

The MAX15104 is designed to achieve low dropout voltage while still maintaining good noise, transient response, and AC rejection. When operating from very noisy sources, supply noise rejection and transient response can be improved by increasing the values of the input and output capacitors. The MAX15104 output noise is typically 15 μ V_{RMS} (see the Noise Density graph in the [Typical Operating Characteristics](#)).

Thermal Considerations in PCB Layout

The rated package dissipation strongly depends on the copper area connected to the regulator. The maximum power dissipation allowed in the package is 1538mW (measured from the MAX15104 EV kit).

More power dissipation can be handled by the package if great attention is given during PCB layout. For example, using the top and bottom copper as a heatsink and connecting the thermal vias to one of the middle layers (GND) transfers the heat from the package into the board more efficiently, resulting in lower junction temperature at high power dissipation in some MAX15104 applications. Furthermore, the solder mask around the IC area on both top and bottom layers can be removed to radiate the heat directly into the air. The maximum allowable power dissipation in the IC is as follows:

$$P_{MAX} = [(T_{J(MAX)} - T_A)/(\theta_{JA})]$$

where $(T_{J(MAX)} - T_A)$ is the temperature difference between the maximum-allowed die junction (+150°C) and the surrounding air.

A sample layout is available on the MAX15104 EV kit.

Ordering Information

PART	TEMP RANGE	PIN-PACKAGE
MAX15104EWL+	-40°C to +85°C	15 WLP

+Denotes a lead(Pb)-free/RoHS-compliant package.

Chip Information

PROCESS: BiCMOS

Package Information

For the latest package outline information and land patterns (footprints), go to www.maximintegrated.com/packages. Note that a "+", "#", or "-" in the package code indicates RoHS status only. Package drawings may show a different suffix character, but the drawing pertains to the package regardless of RoHS status.

PACKAGE TYPE	PACKAGE CODE	OUTLINE NO.	LAND PATTERN NO.
15 WLP	W151B2+1	21-0205	Refer to Application Note 1891

Revision History

REVISION NUMBER	REVISION DATE	DESCRIPTION	PAGES CHANGED
0	4/12	Initial release	—
1	8/16	Update <i>Absolute Maximum Ratings</i> section	2

For pricing, delivery, and ordering information, please contact Maxim Direct at 1-888-629-4642, or visit Maxim Integrated's website at www.maximintegrated.com.

Maxim Integrated cannot assume responsibility for use of any circuitry other than circuitry entirely embodied in a Maxim Integrated product. No circuit patent licenses are implied. Maxim Integrated reserves the right to change the circuitry and specifications without notice at any time. The parametric values (min and max limits) shown in the Electrical Characteristics table are guaranteed. Other parametric values quoted in this data sheet are provided for guidance.