

MOTOR SPECIFICATIONS

Part Number	BL17E28-01D-03RO
Length Dimension	71 mm [2.80 in]
Rated Voltage	24 VDC
Rated Output Power	60 W
Pole Number	6
Phase Number	3
Rated Speed	4000 RPM
Max Speed	5000 RPM
Rated Torque	0.144 N-m [20.39 oz-in]
Rated Current	3.1 Amps
Back EMF Constant	3.15Vrms/krpm [4.45 Vpeak/krpm]
Moment of Inertia	0.0000072 kg-m ² [0.39 oz-in ²]
Resistance	0.68 Ohms
Inductance	0.6 mH
Weight	0.55 kg [1.21 lb]

ENCODER SPECIFICATIONS

Part Number	E5 Encoder
Type	Optical Incremental Encoder
Resolution	1000 CPR
Index	Yes
Output Type:	Differential

MOTOR OPERATING SPECIFICATIONS

Hall Effect Angle	120° electrical Angle
Radial Play	0.002 in [0.05 mm] @ 0.99 lbs [0.45 kg]
End Play	0.003 in [0.08 mm] @ 99.21 lbs [45.00 kg]
Max. Radial Force	0.394 in [10.00 mm] @ 3.37 lbs [1.53kg]
Max. Axial Force	2.25 lbs [1.02 kg]
Insulation Class	Class B
Dielectric Strength	500 VDC for 1 minute
Insulation Resistance	100 Ω min. 500 VDC
Ambient Operating Temp.	-20°C to 50°C
Storage Temperature	-20°C to 100°C
Humidity Range (%)	85% (RH) non-condensing

DIMENSIONS

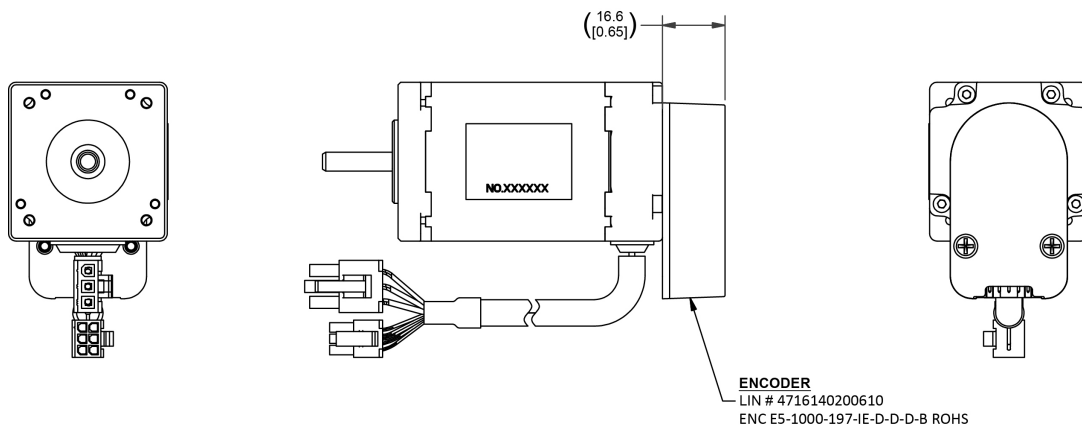
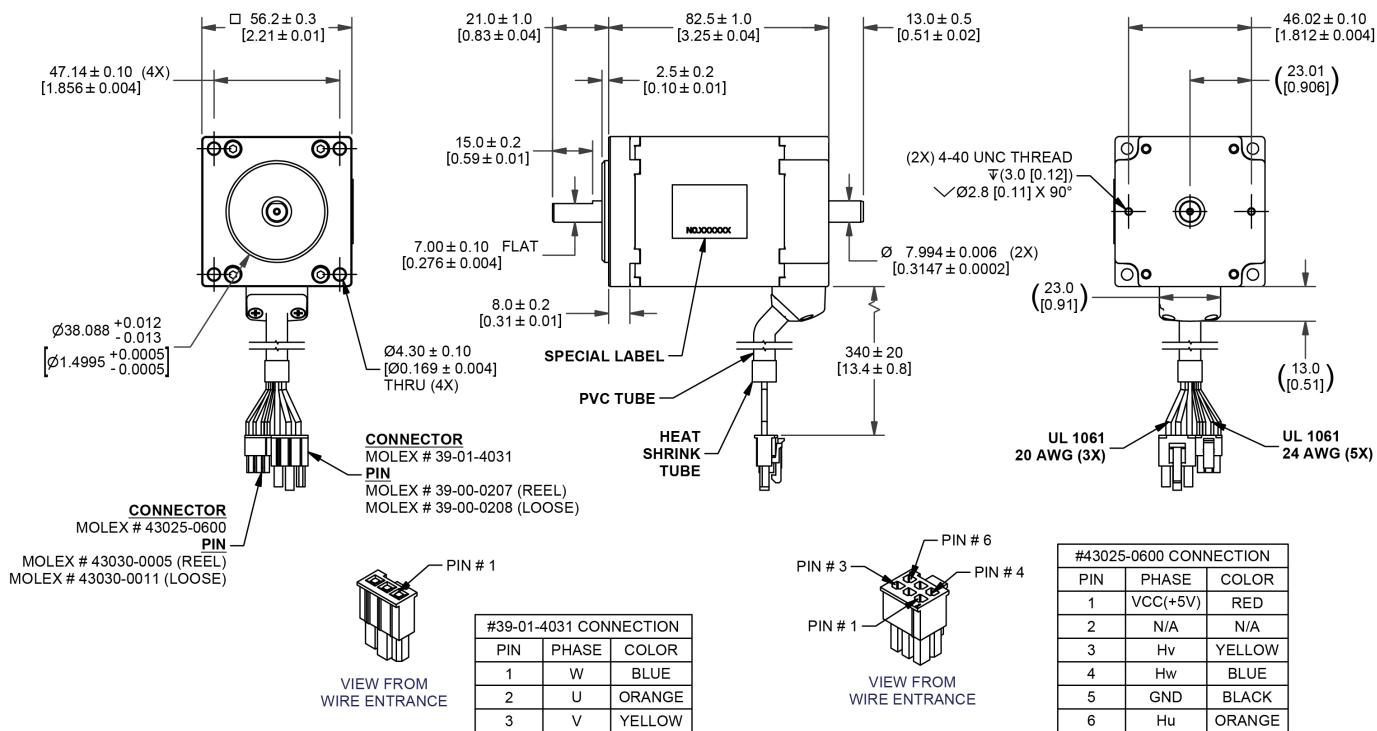

RECOMMENDED PRODUCTS



BLDC DRIVER
BLDC50-BL17E28-01



BLDC EXTENSION CABLE
4201-100/300



E5 ENCODER CABLE
CA-FC10-SH-NC-10-PKG

PERFORMANCE CURVE

BL17E28-01

Rated Voltage: 24Volts, Rated Current: 3.28 Amps

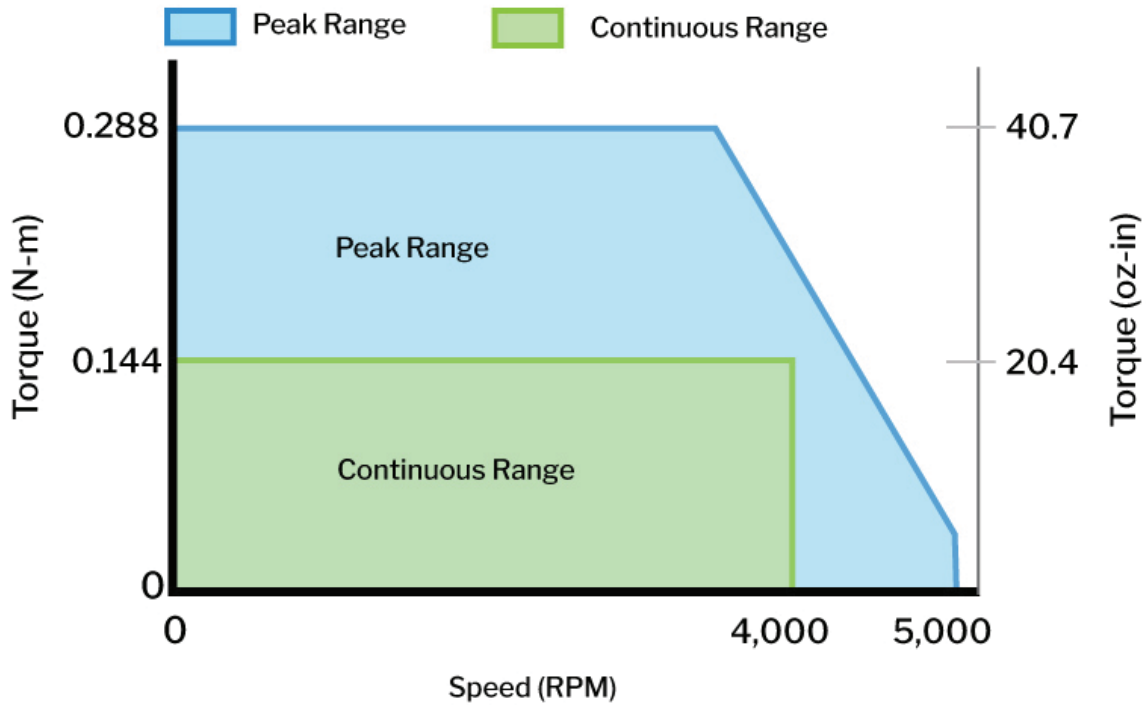

OPERATION & USAGE TIPS

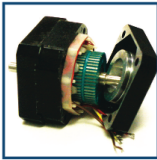

Do not disassemble motors; a significant reduction in motor performance will occur.

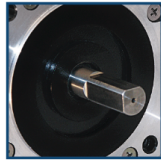

Do not machine shafts; this will have a negative effect on shaft run out and perpendicularity.

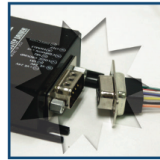

Do not disconnect motor from drive while in operation.

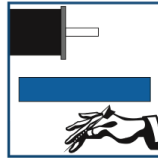

Do not use holding torque/detent torque of motor as a fail safe brake.

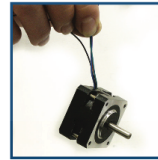

Do not hold motor by lead wires.



Do not exceed the rated current; this will burn the motor.

FAILURE TO COMPLY WITH THESE RECOMMENDATIONS WILL VOID ALL WARRANTY TERMS

Motion Control, **Solved.**

MOTOR ENGINEERING & MANUFACTURING



Optimized
For Your
Application



Quick
Prototype
Turnaround



Small Batch
to OEM Volume
Production



US Based
Support &
Manufacturing