

Data sheet | Item number: 789-804

Switching module; with latching pushbutton; Switching voltage: 250 VAC;

Switching current: 16 A

www.wago.com/789-804

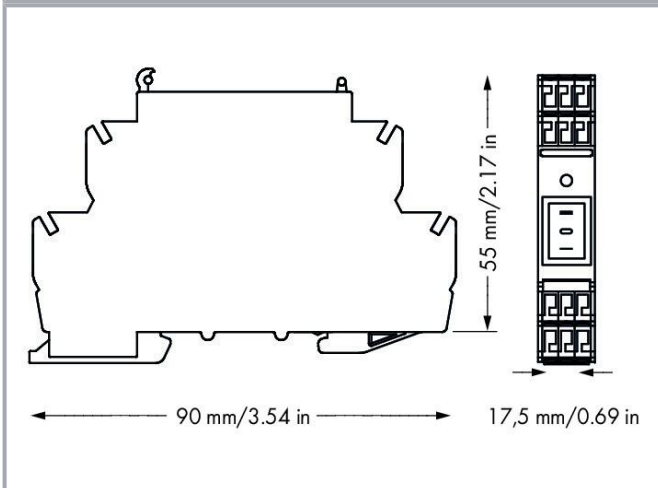
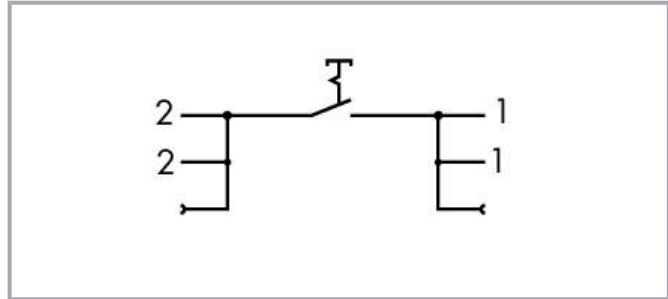

Data

Electrical data

Operating voltage	≤250 VAC
Switching current (resistive) max.	16 A
Inrush current (max.)	100 A (Capacitive)
Switching voltage (max.)	AC 250 V
Contact resistance	≤ 100 mΩ (12 V/1 ADC; New condition)
Insulation resistance	≥ 100 MΩ (500 VDC; New condition)

Subject to changes. Please also observe the further product documentation!

WAGO GmbH & Co. KG
Hansastr. 27
32423 Minden
Phone: +49571 887-0 | Fax: +49571 887-169
Email: info.de@wago.com | Web: www.wago.com

Do you have any questions about our products?
We are always happy to take your call at +49 (571) 887-44222.



Electrical life (NO; resistive load; 23 °C)	10 x 10 ³ switching operations
Mechanical life	50 x 10 ³ switching operations

Safety and protection

Rated voltage	250 V
Rated surge voltage	4 kV
Pollution degree	2
Dielectric strength (open contact) (AC, 1 min)	1.25 kV _{rms}

Connection data

Connection technology	CAGE CLAMP®
Solid conductor	02 ... 2.5 mm ² / 24 ... 14 AWG
Fine-stranded conductor	0.2 ... 2.5 mm ² / 24 ... 14 AWG
Strip length	9 ... 10 mm / 0.35 ... 0.39 inches

Physical data

Width	17.5 mm / 0.689 inches
Height	90 mm / 3.543 inches
Depth from upper-edge of DIN-rail	55 mm / 2.165 inches

Mechanical Data

Mounting type	DIN-35 rail
Housing design	DIN-rail-mount enclosure

Material Data

Contact material (switch)	Ag alloy
Fire load	3.404 MJ
Weight	40.8 g

Environmental requirements

Ambient temperature (operation)	-20 ... +55 °C
Ambient temperature (storage)	-40 ... +80 °C

Commercial data

Product Group	6 (INTERFACE ELECTRONIC)
---------------	--------------------------

Subject to changes. Please also observe the further product documentation!

eCl@ss 10.0	27-37-16-01
eCl@ss 9.0	27-37-16-01
ETIM 8.0	EC001437
ETIM 7.0	EC001437
PU (SPU)	10 (1) pcs
Packaging type	box
Country of origin	DE
GTIN	4050821274834
Customs tariff number	85365080900

Environmental Product Compliance

RoHS Compliance Status	Compliant, No Exemption
------------------------	-------------------------

Approvals / Certificates

General approvals

Logo	Approval	Additional Approval Text	Certificate name
	EAC Brjansker Zertifizierungsstelle	TP TC 004/2011	EAC RU C-DE.AM02.B.00122 /19

Optional accessories



Marking accessories

Marker			
	Item no.: 248-504 Mini-WSB marking card; as card; MARKED; 21 ... 30 (10x); not stretchable; Horizontal marking; snap-on type; white		www.wago.com/248-504

Jumpers

Jumper			
	Item no.: 789-112 Jumper; 12-way; silver-colored		www.wago.com/789-112

Ferrule

Ferrule			
	Item no.: 216-241 Ferrule; Sleeve for 0.5 mm ² / 20 AWG; insulated; electro-tin plated; electrolytic copper; gastight crimped; acc. to DIN 46228, Part 4/09.90; white		www.wago.com/216-241
	Item no.: 216-242 Ferrule; Sleeve for 0.75 mm ² / 18 AWG; insulated; electro-tin plated; electrolytic copper; gastight		www.wago.com/216-242

Subject to changes. Please also observe the further product documentation!

crimped; acc. to DIN 46228, Part 4/09.90; gray

**Item no.: 216-243**

Ferrule; Sleeve for 1 mm² / AWG 18; insulated; electro-tin plated; electrolytic copper; gastight crimped; www.wago.com/216-243
acc. to DIN 46228, Part 4/09.90; red

**Item no.: 216-244**

Ferrule; Sleeve for 1.5 mm² / AWG 16; insulated; electro-tin plated; electrolytic copper; gastight www.wago.com/216-244
crimped; acc. to DIN 46228, Part 4/09.90; black

Tool

Operating tool

**Item no.: 210-720**

Operating tool; Blade: 3.5 x 0.5 mm; with a partially insulated shaft; multicoloured

www.wago.com/210-720

Downloads**Documentation****Bid Text**

789-804 X81 - Datei	2019 Feb 19	xml 3.9 kB	Download
------------------------	-------------	---------------	----------

789-804 doc - Datei	2015 Feb 10	doc 26.1 kB	Download
------------------------	-------------	----------------	----------

Instruction Leaflet

		pdf 1.3 MB	Download
--	--	---------------	----------

Additional Information

Disposal and Recycling Electrical and electronic equipment, Batteries, Packaging	V 1.1.0 2022 Aug 18	pdf 2.2 MB	Download
---	------------------------	---------------	----------

CAD/CAE-Data**CAE data**

EPLAN Data Portal 789-804	URL	Download
---------------------------	-----	----------

ZUKEN Portal 789-804	URL	Download
----------------------	-----	----------

WSCAD Universe 789-804	URL	Download
------------------------	-----	----------

Subject to changes. Please also observe the further product documentation!

CAD data

2D/3D Models 789-804

[URL](#)

[Download](#)

Environmental Product Compliance

Compliance Search

Environmental Product Compliance 789-804

[URL](#)

[Download](#)

Switching module; with latching pushbutton; Switching voltage: 250 VAC; Switching current: 16 A

Installation Notes

Conductor termination

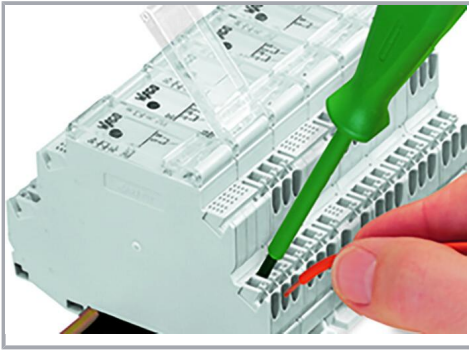

Inserting a conductor.

Subject to changes. Please also observe the further product documentation!