

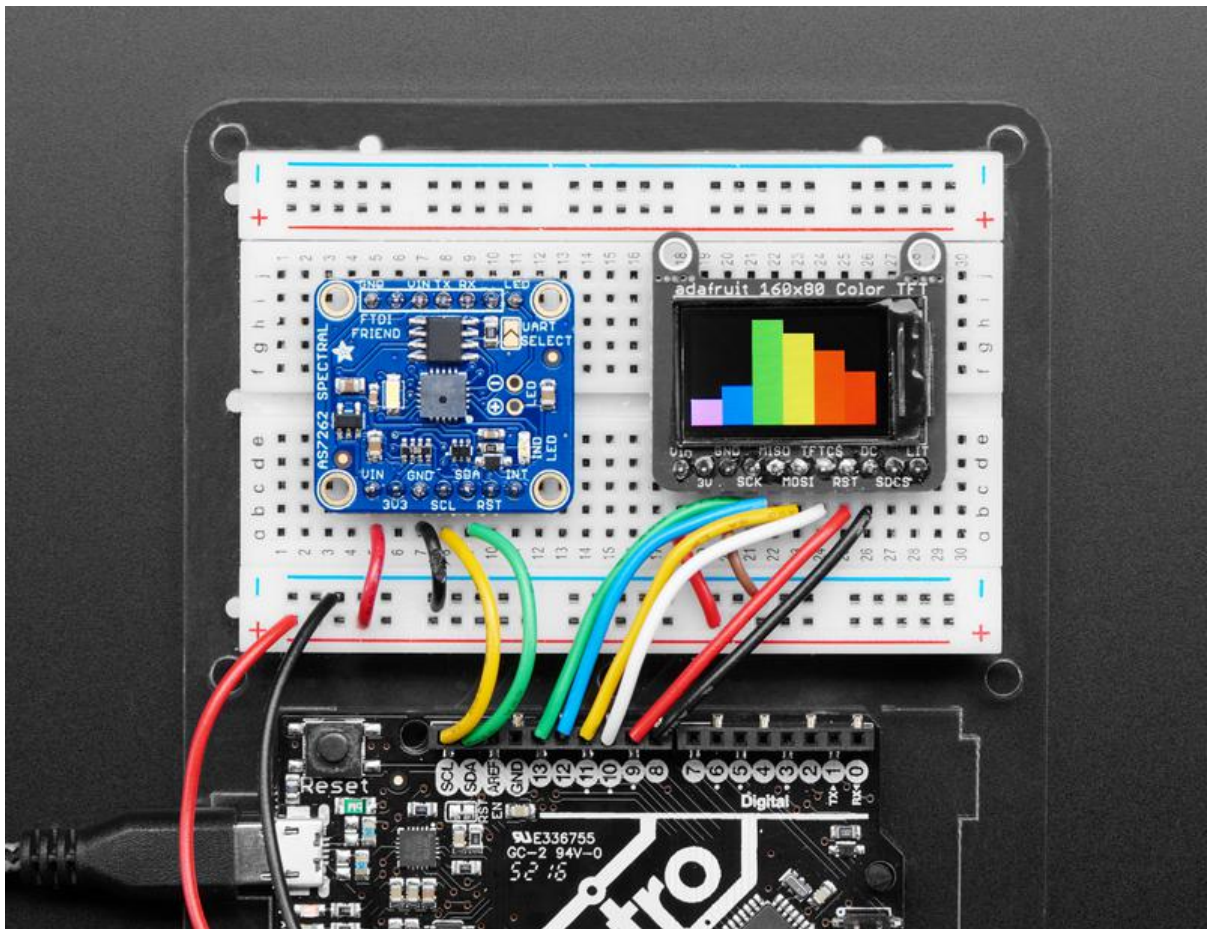

# Adafruit AS7262 6-channel Visible Light Sensor

Created by Dean Miller



<https://learn.adafruit.com/adafruit-as7262-6-channel-visible-light-sensor>

Last updated on 2022-12-01 03:11:35 PM EST

# Table of Contents

Overview	3
Pinouts	5
<ul style="list-style-type: none"><li>• Power Pins:</li><li>•</li><li>• Logic pins:</li><li>• UART Logic pins:</li></ul>	
Arduino Wiring & Test	6
<ul style="list-style-type: none"><li>• I2C Wiring</li><li>• Download Adafruit_AS726x library</li><li>• Load Test Example</li><li>• TFT Demo</li></ul>	
Python & CircuitPython	12
<ul style="list-style-type: none"><li>• CircuitPython Microcontroller Wiring - I2C</li><li>• CircuitPython Microcontroller Wiring - UART</li><li>• Python Computer Wiring - I2C</li><li>• CircuitPython Installation of AS726x Library</li><li>• Python Installation of AS726x Library</li><li>• CircuitPython &amp; Python Usage</li></ul>	
Python Docs	17
Downloads	17
<ul style="list-style-type: none"><li>• Documents</li><li>• Schematic</li><li>• Dimensions</li></ul>	

---

# Overview

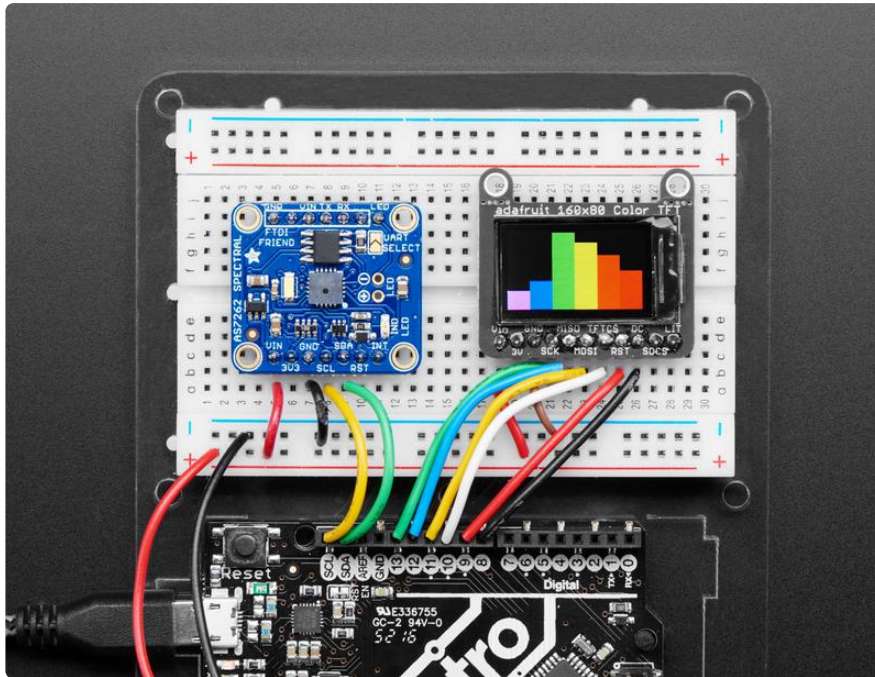

The colors of the rainbow, so pretty in the sky  
Are also in this sensor, controlled by you and I!

Detect trees of green, and red roses too with the new Adafruit AS7262 6-Channel Visible Light / Color Sensor Breakout. This sensor from AMS has 6 integrated visible light sensing channels for red, orange, yellow, green, blue, and violet. These channels can be read via the I2C bus as either raw 16-bit values or calibrated floating-point values. There is also an on-board temperature sensor that can be used to read the temperature of the chip, and a powerful LED flash to reflect light off objects for better color detection.

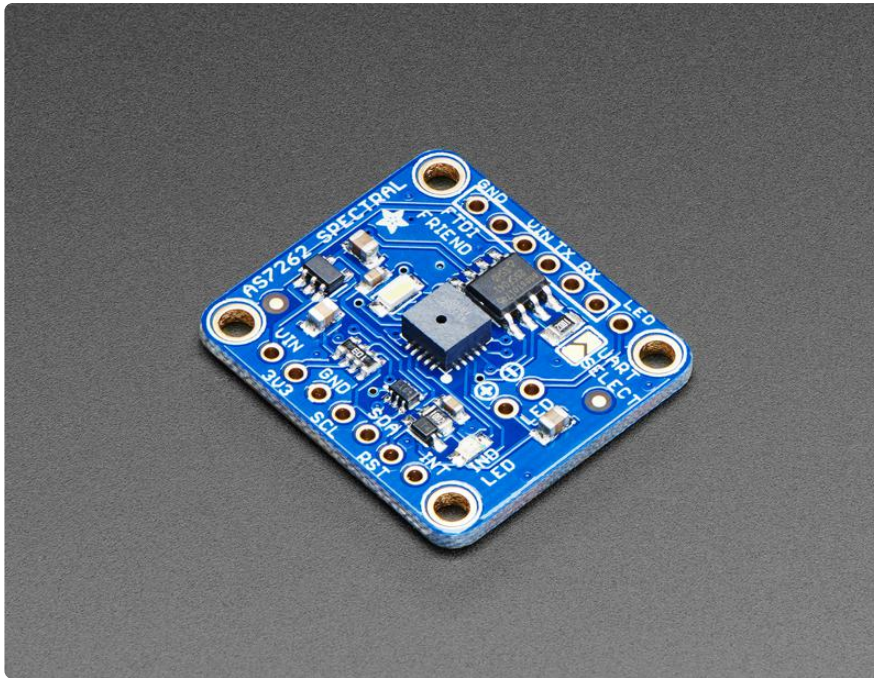

The 6 channels on the AS7262 are realized by silicon interference filters at 450nm, 500nm, 550nm, 570nm, 600nm, and 650nm. This breakout uses the I2C interface on the chip by default, but a UART interface that accepts AT commands is also selectable.

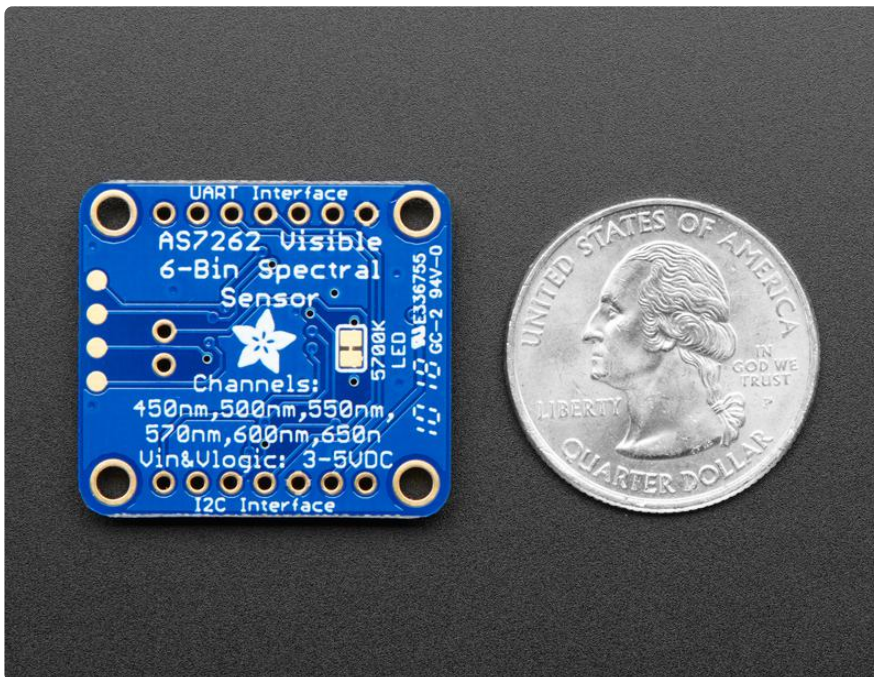

We've placed the sensor on a PCB for you and included an SPI flash chip pre-programmed with the device firmware, a 3.3V regulator, I2C level shifting, and the recommended LED with 5700K color temperature. Both the I2C and UART interfaces are broken out, making this breakout an excellent all-in-one solution for all your color-

sensing needs. The pinout for the UART interface is plug-and-play compatible with the Adafruit FTDI Friend.

We've also prepared software libraries to get you up and running in Arduino or CircuitPython with just a few lines of code!

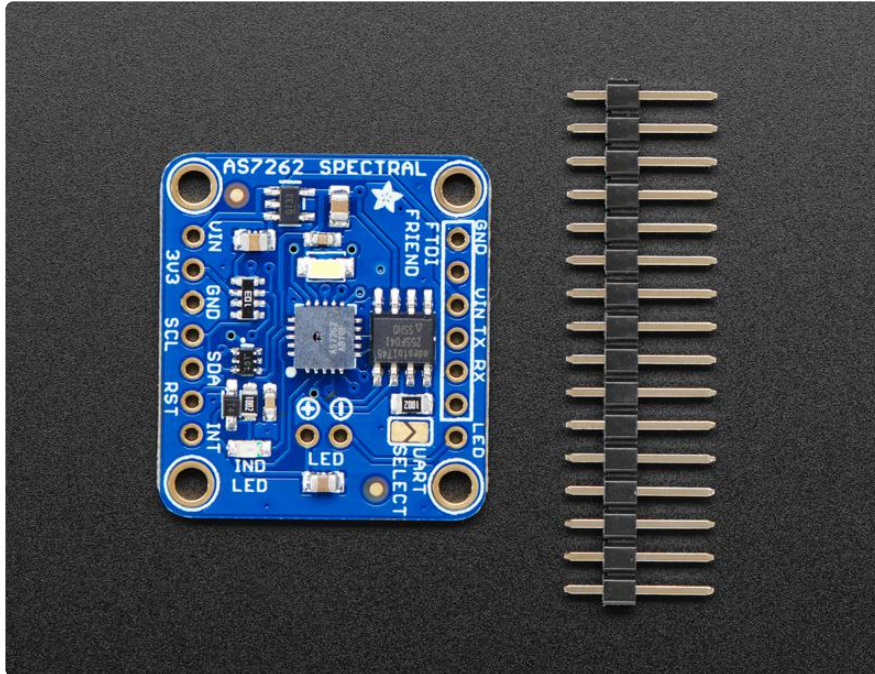

## Pinouts

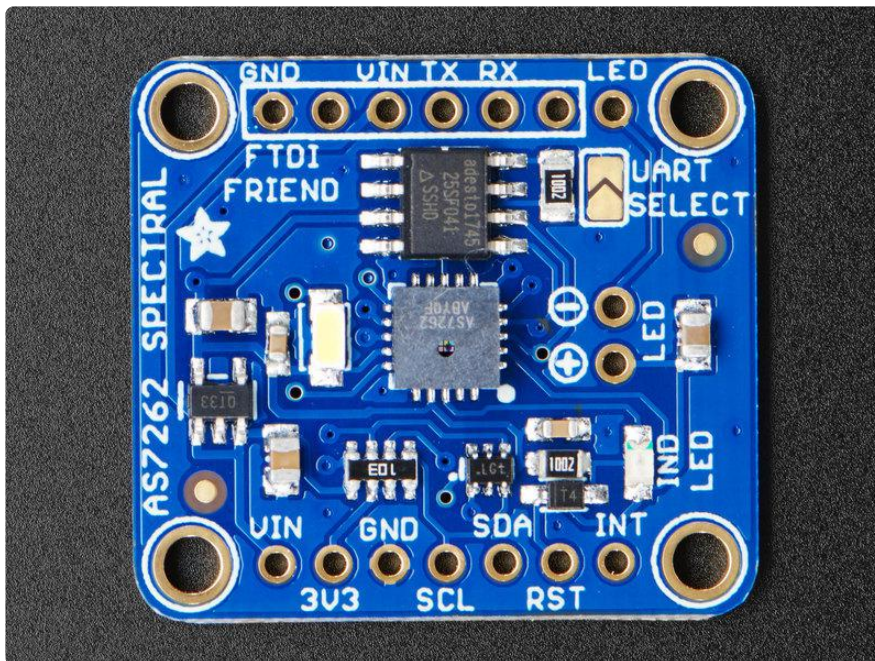

This sensor has 4 mounting holes and 2 header breakout strips.

## Power Pins:

- Vin - this is the power pin. Since the sensor uses 3.3V, we have included an onboard voltage regulator that will take 3-5VDC and safely convert it down. To power the board, give it the same power as the logic level of your microcontroller - e.g. for a 5V micro like Arduino, use 5V
- 3Vo - this is the 3.3V output from the voltage regulator, you can grab up to 100mA from this if you like
- GND - common ground for power and logic

## Logic pins:

- SCL - this is the I2C clock pin, connect to your microcontrollers I2C clock line. There is a 10K pullup on this pin and it is level shifted so you can use 3 - 5VDC. If UART mode is selected, this pin acts as RX.
- SDA - this is the I2C data pin, connect to your microcontrollers I2C data line. There is a 10K pullup on this pin and it is level shifted so you can use 3 - 5VDC. If UART mode is selected, this pin acts as TX.
- RST - this is the reset pin. When it is pulled to ground the sensor resets itself. This pin is level shifted so you can use 3-5VDC logic.

Solder closed the UART SELECT jumper to switch the sensor into UART mode.

## UART Logic pins:

- TX - this is the UART transmit pin, connect to your microcontrollers UART RX line. There is a 10K pullup on this pin and it is level shifted so you can use 3 - 5VDC. If I2C mode is selected, this pin acts as SCL.
- RX - this is the UART receive pin, connect to your microcontrollers UART TX line. There is a 10K pullup on this pin and it is level shifted so you can use 3 - 5VDC. If I2C mode is selected, this pin acts as SDA.

---

## Arduino Wiring & Test

You can easily wire this breakout to any microcontroller, we'll be using an Adafruit Metro M0 Express (Arduino compatible) with the Arduino IDE. But, you can use any other kind of microcontroller as well as long as it has I2C clock and I2C data lines.

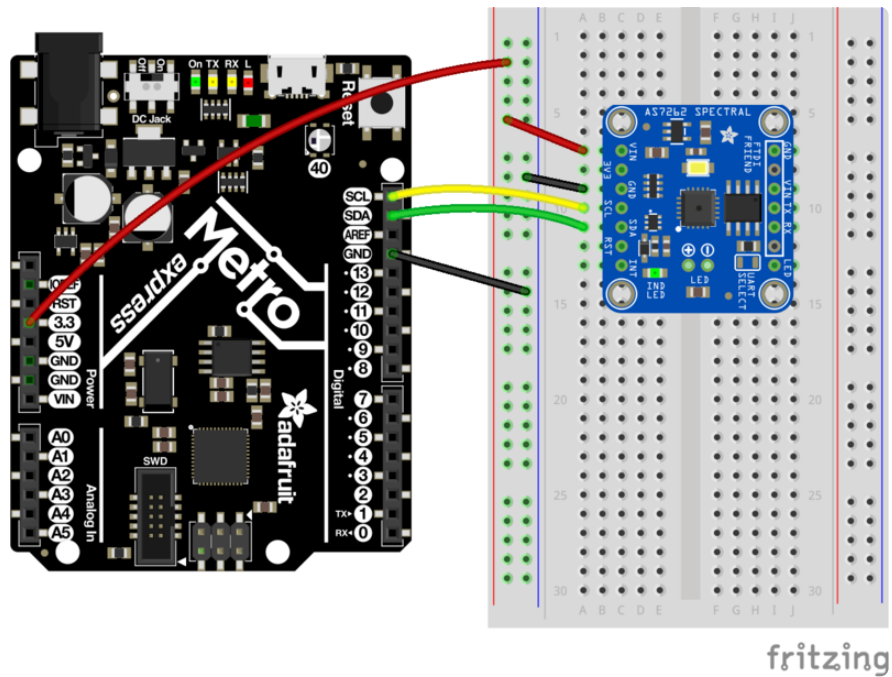

## I2C Wiring

- Connect Vin to the power supply, 3-5V is fine. Use the same voltage that the microcontroller logic is based off of. For most Arduinos, that is 5V
- Connect GND to common power/data ground
- Connect the SCL pin to the I2C clock SCL pin on your Arduino.  
On an UNO & '328 based Arduino, this is also known as A5, on a Mega it is also known as digital 21 and on a Leonardo/Micro, digital 3
- Connect the SDA pin to the I2C data SDA pin on your Arduino.  
On an UNO & '328 based Arduino, this is also known as A4, on a Mega it is also known as digital 20 and on a Leonardo/Micro, digital 2

This sensor uses I2C address 0x49.

## Download Adafruit\_AS726x library

To begin reading sensor data, you will need to download Adafruit\_AS726x from the Arduino library manager.

Open up the Arduino library manager:

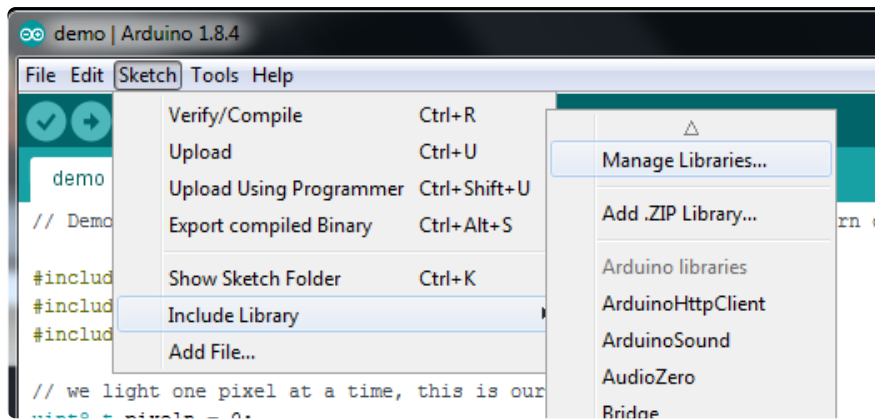

Search for the Adafruit AS726X library and install it



We also have a great tutorial on Arduino library installation at:

<http://learn.adafruit.com/adafruit-all-about-arduino-libraries-install-use> ()

## Load Test Example

Open up File->Examples->Adafruit\_AS726x->AS7262\_test and upload to your Arduino wired up to the sensor. This example connects to the sensor and starts taking readings.

Once uploaded to your Arduino, open up the serial console at 9600 baud speed to see the readings. Your sensor will read the temperature and it's 6 visible light channels. Your serial monitor will look something like this:



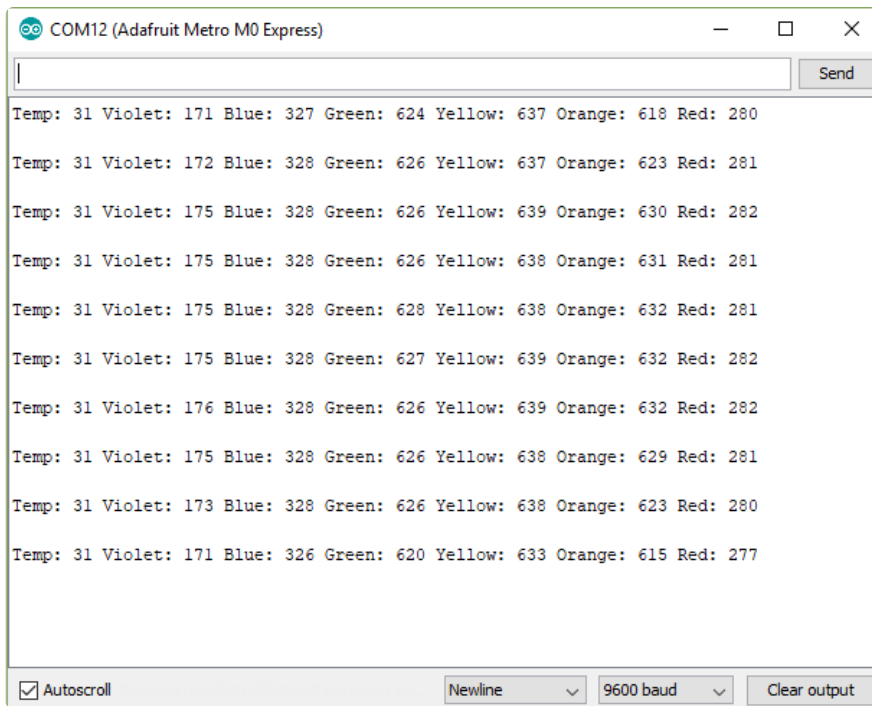

## TFT Demo

You can create a nice bar graph of the sensors 6 color channels using a 0.90 inch TFT from Adafruit.

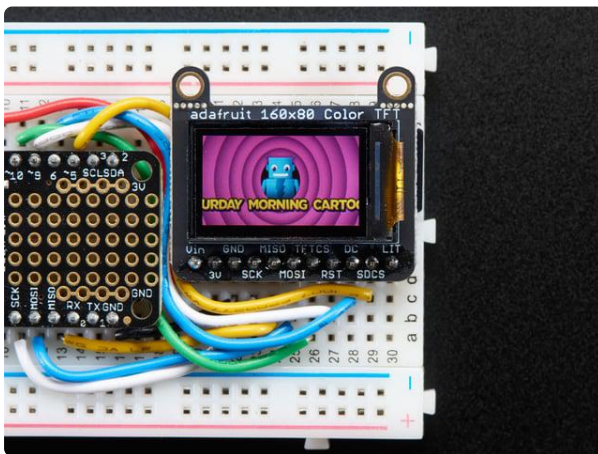

[Adafruit 0.96" 160x80 Color TFT Display w/ MicroSD Card Breakout](https://www.adafruit.com/product/3533)

Say hello to our 0.96" 160x80 Color TFT Display w/ MicroSD Card Breakout – we think it's...

<https://www.adafruit.com/product/3533>

Wire the TFT up as shown:

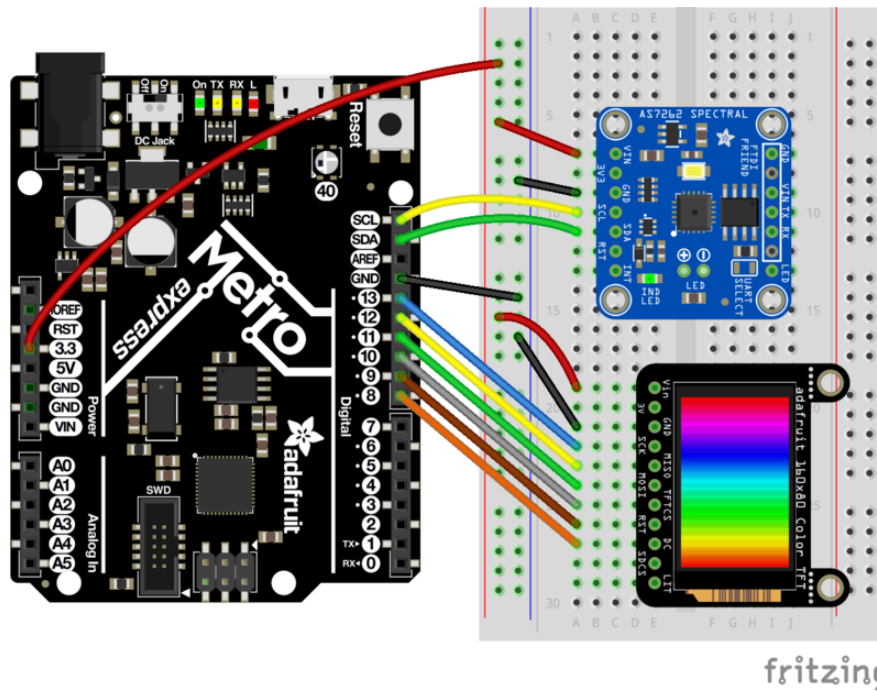

Upload the following code to your board through the Arduino IDE (the code is also available under File->Examples->Adafruit\_AS726x->color\_graph)

```

/*****
  This is a library for the Adafruit AS7262 6-Channel Visible Light Sensor

  This sketch reads the sensor and creates a color bar graph on a tiny TFT

  Designed specifically to work with the Adafruit AS7262 breakout and 160x18 tft
  ----> http://www.adafruit.com/products/3779
  ----> http://www.adafruit.com/product/3533

  These sensors use I2C to communicate. The device's I2C address is 0x49
  Adafruit invests time and resources providing this open source code,
  please support Adafruit and open-source hardware by purchasing products
  from Adafruit!

  Written by Dean Miller for Adafruit Industries.
  BSD license, all text above must be included in any redistribution
  *****/

#include <Wire.h>
#include "Adafruit_AS726x.h"

#include <Adafruit_GFX.h> // Core graphics library
#include <Adafruit_ST7735.h> // Hardware-specific library
#include <SPI.h>

// For the breakout, you can use any 2 or 3 pins
// These pins will also work for the 1.8" TFT shield
#define TFT_CS 10
#define TFT_RST 9 // you can also connect this to the Arduino reset
// in which case, set this #define pin to -1!
#define TFT_DC 8

#define SENSOR_MAX 5000

#define BLACK 0x0000
#define GRAY 0x8410

```

```

#define WHITE    0xFFFF
#define RED      0xF800
#define ORANGE   0xFA60
#define YELLOW   0xFFE0
#define LIME     0x07FF
#define GREEN    0x07E0
#define CYAN     0x07FF
#define AQUA     0x04FF
#define BLUE     0x001F
#define MAGENTA  0xF81F
#define PINK     0xF8FF

uint16_t colors[] = {
    MAGENTA,
    BLUE,
    GREEN,
    YELLOW,
    ORANGE,
    RED
};

Adafruit_ST7735 tft = Adafruit_ST7735(TFT_CS, TFT_DC, TFT_RST);

//create the object
Adafruit_AS726x ams;

//buffer to hold raw values (these aren't used by default in this example)
//uint16_t sensorValues[AS726x_NUM_CHANNELS];

//buffer to hold calibrated values
float calibratedValues[AS726x_NUM_CHANNELS];

uint16_t barWidth;

void setup() {
    Serial.begin(9600);

    tft.initR(INITR_MINI160x80); // initialize a ST7735S chip, mini display
    tft.setRotation(3);

    tft.fillScreen(ST7735_BLACK);

    barWidth = tft.width() / AS726x_NUM_CHANNELS;

    // initialize digital pin LED_BUILTIN as an output.
    pinMode(LED_BUILTIN, OUTPUT);

    //begin and make sure we can talk to the sensor
    if(!ams.begin()){
        Serial.println("could not connect to sensor! Please check your wiring.");
        while(1);
    }

    ams.setConversionType(MODE_2);

    //uncomment this if you want to use the driver LED (off by default)
    //ams.drvOn();
}

void loop() {
    if(ams.dataReady()){
        //read the values!
        //ams.readRawValues(sensorValues);
        ams.readCalibratedValues(calibratedValues);

        for(int i=0; i<AS726x_NUM_CHANNELS; i++){

```

```

uint16_t height = map(calibratedValues[i], 0, SENSOR_MAX, 0, tft.height());
tft.fillRect(barWidth * i, 0, barWidth, tft.height() - height, ST7735_BLACK);
tft.fillRect(barWidth * i, tft.height() - height, barWidth, height,
colors[i]);
}
}
}

```

## Python & CircuitPython

It's easy to use the AS7262 with Python or CircuitPython and the [Adafruit CircuitPython AS726x \(\)](#) module. This module allows you to easily write Python code that reads color data and temperature from the sensor.

You can use this sensor with any CircuitPython microcontroller board or with a computer that has GPIO and Python [thanks to Adafruit\\_Blinka, our CircuitPython-for-Python compatibility library \(\)](#).

## CircuitPython Microcontroller Wiring - I2C

You can easily wire this breakout to a microcontroller running CircuitPython. We will be using a Metro M0 Express.

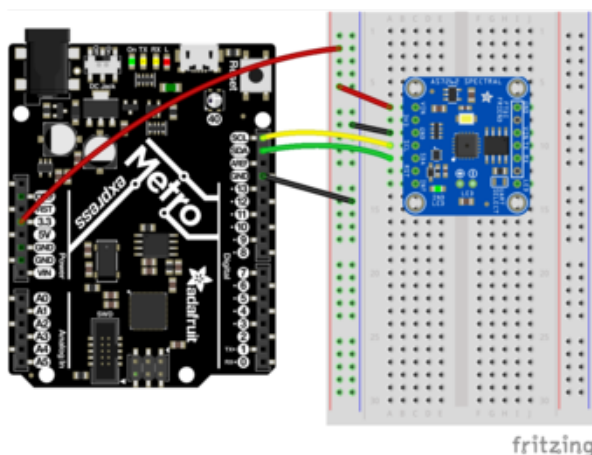

Connect Vin to the power supply, 3-5V is fine  
 Connect GND to common power/data ground  
 Connect the SCL pin to the I2C clock SCL pin on your Feather or Metro M0 (on a Gemma M0 this would be Pad #2/ A1)  
 Connect the SDA pin to the I2C data SDA pin on your Feather or Metro M0 (on a Gemma M0 this would be Pad #0/A2)

## CircuitPython Microcontroller Wiring - UART

Here's the wiring to use for UART:

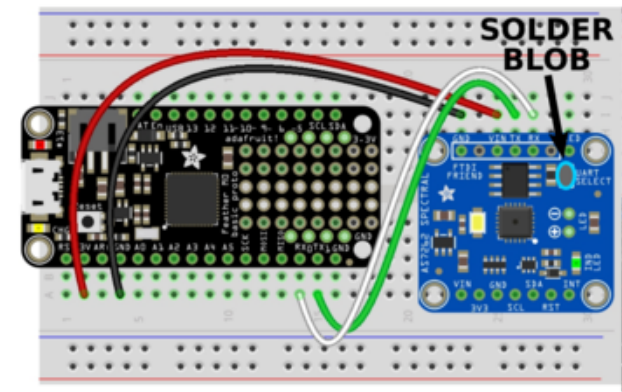

Feather 3V to board VIN  
 Feather GND to board GND  
 Feather RX to board RX\*  
 Feather TX to board TX\*

\* Yep, TX to TX and RX to RX, that appears to be the way the AS726x has named things.

Don't forget to solder the UART SELECT jumper to enable UART mode.

## Python Computer Wiring - I2C

Since there's dozens of Linux computers/boards you can use we will show wiring for Raspberry Pi. For other platforms, [please visit the guide for CircuitPython on Linux to see whether your platform is supported \(\)](#).

Here's the Raspberry Pi wired with I2C:

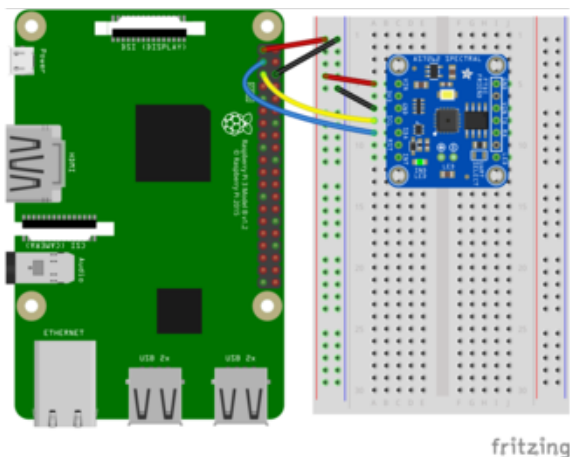

Pi 3V3 to sensor VIN  
 Pi GND to sensor GND  
 Pi SDA to sensor SDA  
 Pi SCL to sensor SCL

This sensor uses I2C address 0x49.

# CircuitPython Installation of AS726x Library

You'll need to install the [Adafruit\\_CircuitPython\\_AS726x library \(\)](#) library on your CircuitPython board.

First make sure you are running the [latest version of Adafruit CircuitPython \(\)](#) for your board.

Next you'll need to install the necessary libraries to use the hardware--carefully follow the steps to find and install these libraries from [Adafruit's CircuitPython library bundle \(\)](#). Our introduction guide has [a great page on how to install the library bundle \(\)](#) for both express and non-express boards.

Remember for non-express boards you'll need to manually install the necessary libraries from the bundle:

- adafruit\_as726x.mpy
- adafruit\_bus\_device
- adafruit\_register

You can also download the adafruit\_as726x.mpy from [it's release page on Github. \(\)](#)

Before continuing make sure your board's lib folder or root filesystem has the adafruit\_as726x.mpy, adafruit\_register, and adafruit\_bus\_device files and folders copied over.

Next [connect to the board's serial REPL \(\)](#) so you are at the CircuitPython >>> prompt.

## Python Installation of AS726x Library

You'll need to install the Adafruit\_Blinka library that provides the CircuitPython support in Python. This may also require enabling I2C on your platform and verifying you are running Python 3. [Since each platform is a little different, and Linux changes often, please visit the CircuitPython on Linux guide to get your computer ready \(\)!](#)

Once that's done, from your command line run the following command:

- `sudo pip3 install adafruit-circuitpython-as726x`

If your default Python is version 3 you may need to run 'pip' instead. Just make sure you aren't trying to use CircuitPython on Python 2.x, it isn't supported!

## CircuitPython & Python Usage

To demonstrate usage we will initialize the sensor and read it's onboard temperature sensor from the board's Python REPL.

Run the following code to import the necessary modules and initialize the I2C connection with the sensor:

### I2C Initialization

For I2C, use the following to create your sensor object:

```
import board
from adafruit_as726x import AS726x_I2C

i2c = board.I2C()
sensor = Adafruit_AS726x_I2C(i2c)
```

### UART Initialization - CircuitPython

For UART usage on a board (like a Feather) running CircuitPython, use the following to create your sensor object:

```
import board
from adafruit_as726x import AS726x_UART

uart = board.UART()
sensor = Adafruit_AS726x_UART(uart)
```

### Usage

Now you can read the temperature property from the sensor:

```
print('Temperature: {0}C'.format(sensor.temperature))
```

As long as you get a reasonable temperature (usually around 28 degrees C) you know your sensor is wired up correctly and working!

Below is a complete example that reads all color channels and prints them out as a graph in the REPL. Save this as code.py on your board and open the REPL to see the output.

```
# SPDX-FileCopyrightText: 2020 ladyada for Adafruit Industries
# SPDX-License-Identifier: MIT

import time
import board

# for I2C use:
from adafruit_as726x import AS726x_I2C

# for UART use:
# from adafruit_as726x import AS726x_UART

# maximum value for sensor reading
max_val = 16000

# max number of characters in each graph
max_graph = 80

def graph_map(x):
    return min(int(x * max_graph / max_val), max_graph)

# for I2C use:
i2c = board.I2C() # uses board.SCL and board.SDA
# i2c = board.STEMMA_I2C() # For using the built-in STEMMA QT connector on a
# microcontroller
sensor = AS726x_I2C(i2c)

# for UART use:
# uart = board.UART()
# sensor = AS726x_UART(uart)

sensor.conversion_mode = sensor.MODE_2

while True:
    # Wait for data to be ready
    while not sensor.data_ready:
        time.sleep(0.1)

    # plot plot the data
    print("\n")
    print("V: " + graph_map(sensor.violet) * "=")
    print("B: " + graph_map(sensor.blue) * "=")
    print("G: " + graph_map(sensor.green) * "=")
    print("Y: " + graph_map(sensor.yellow) * "=")
    print("O: " + graph_map(sensor.orange) * "=")
    print("R: " + graph_map(sensor.red) * "=")

    time.sleep(1)
```

Running the above code should something like this in your REPL:



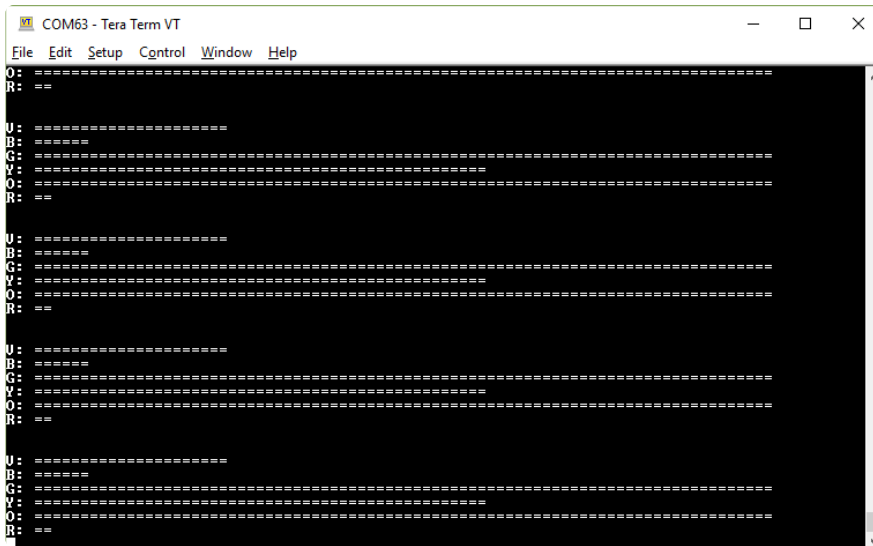

---

## Python Docs

[Python Docs \(\)](#)

---

## Downloads

## Documents

- [AS726x Datasheet \(\)](#)
- [AS726x Arduino Driver \(\)](#)
- [AS726x CircuitPython Driver \(\)](#)
- [Fritzing object in the Adafruit Fritzing Library \(\)](#)
- [AS7262 Breakout PCB files \(EAGLE format\) \(\)](#)

## Schematic

click to enlarge

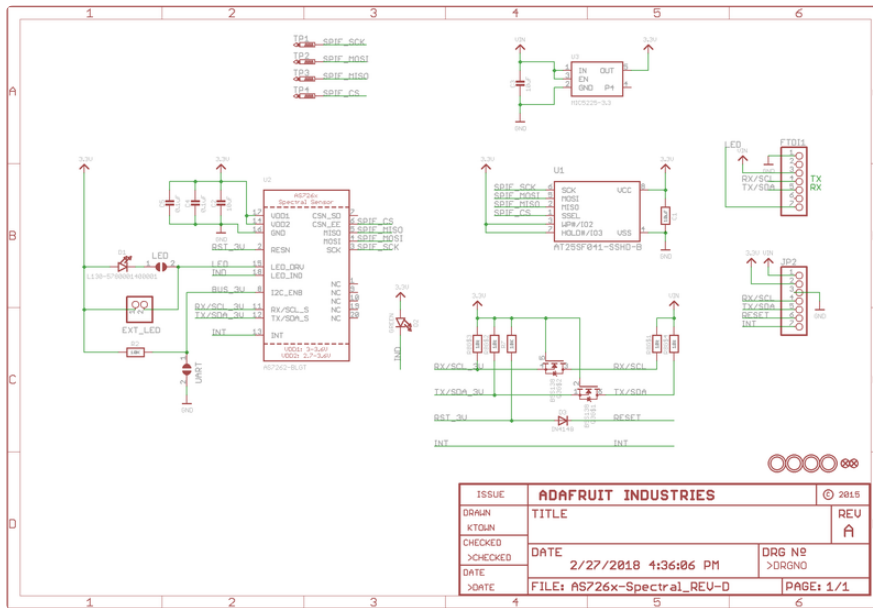

# Dimensions

in inches. Click to enlarge

