

EnerChip™ CC Real-Time Clock Evaluation Kit

System Features and Overview

CBC-EVAL-06 is a demonstration kit featuring the Cymbet EnerChip CBC3112 backup power and battery management circuit coupled with the Micro Crystal low power RV-2123 real-time clock (RTC) with integrated crystal.

The kit demonstrates just how compact an RTC and backup power solution can be using the low profile surface mount devices from Cymbet and Micro Crystal. The combined board space of the two-chip solution including RTC, crystal oscillator, rechargeable backup power source, and power management circuits, is **only 0.65 cm²**.

CBC-EVAL-06 has the following elements:

- Solid state rechargeable energy storage in low profile surface mount package, for real-time clock backup power
- Integrated battery management that controls battery charging and discharge cutoff, ensuring maximum service life of on-board storage cells
- Integrated real-time clock and crystal oscillator in small ceramic surface mount package with SPI bus
- USB connector for easy demonstration on personal computer
- Input/output access to board for easy connection to external microcontroller

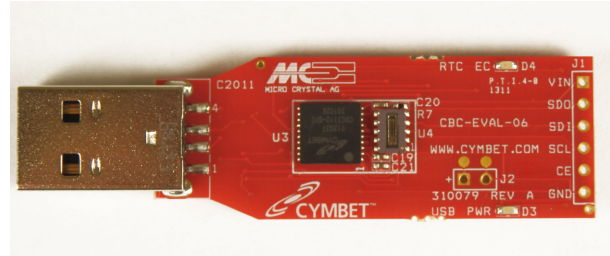

Figure 1: CBC-EVAL-06 Demo Kit.

Smallest RTC Power Backup Footprint

As shown above in Figure 1, the CBC-EVAL-06 demonstrates an extremely compact RTC power backup solution. The EnerChip CC CBC3112 is on the left and the Micro Crystal 2123 is on the right inside the white box. The block diagram of this simple two chip solution is shown in Figure 2.

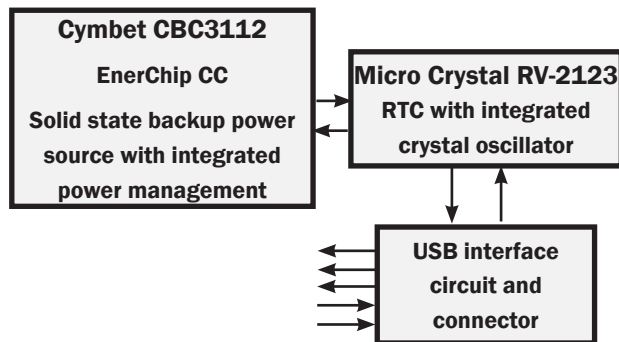
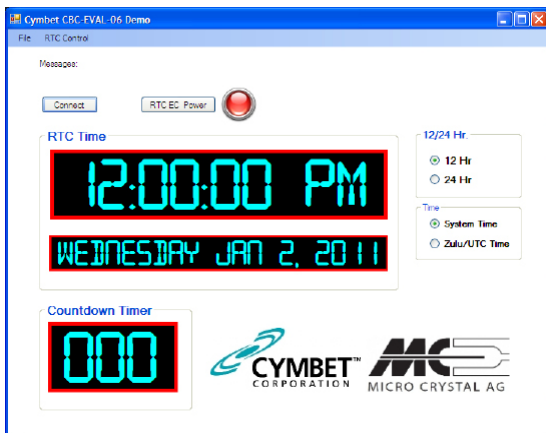

Figure 2: EnerChip CBC-EVAL-06 Demo Kit block diagram.

EVAL-06 Graphical User Interface

The CBC-EVAL-06 includes an easy to use PC based software application that communicates with the USB stick. Users can set the time of day, date and count-down timer values to experiment with RTC power-backup. The software works with Microsoft Windows XP and Windows 7 operating systems. Once the EVAL-06 USB stick is inserted into the PC, the Connect button is clicked in the GUI. This establishes communication over the USB port and the time, date and countdown selections are written to the RTC. The EVAL-06 can then be removed from the PC and the RTC will be powered by the EnerChip CC CBC3112.



CBC-EVAL-06 EnerChip CC RTC Evaluation Kit

CBC-EVAL-06 Module Connector, Jumpers, and Test Points

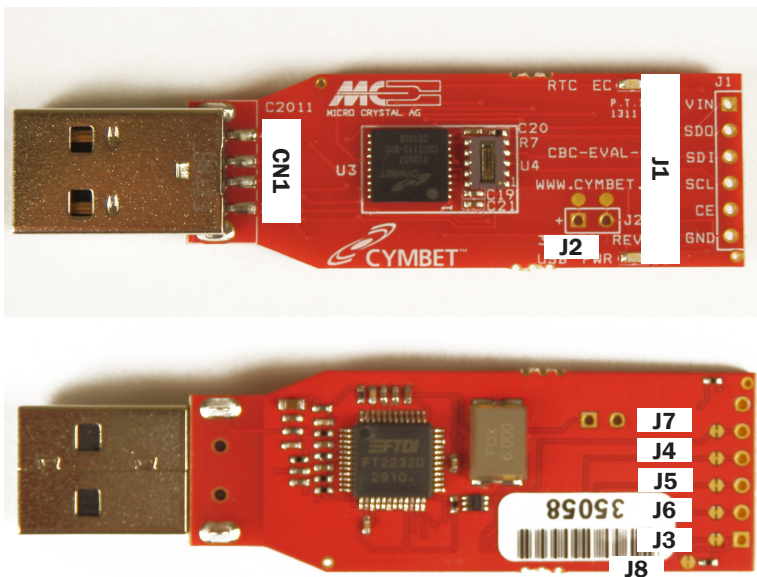

Figure 3: Locations of Connector and Jumpers.

JUMPERS AND CONNECTORS		
Jumper	Pin Number	Designation
J1	1	VIN
	2	SDO
	3	SDI
	4	SCL
	5	CE
	6	GND
J2	1	EXT ENERCHIP (+)
	2	EXT ENERCHIP (-) [GND]
J3	Trace	RTC PWR
J4	Trace	SCL
J5	Trace	SDI
J6	Trace	SDO
J7	Trace	CE
J8	Trace	RTCPWR LED (optional cut)
CN1	1	VDD (indirect)
	2	USBDM (indirect)
	3	USBDP and RSTOUT# (indirect)
	4	GND

CBC-EVAL-06 EnerChip CC RTC Evaluation Kit

Getting Started

For first time users who have not installed the demonstration software, follow these steps:

Insert the EVAL-06 Kit CD-ROM into the CD drive.

If the Microsoft .NET Framework Client Profile has not been loaded, a window will appear as shown below. Click 'Accept.'

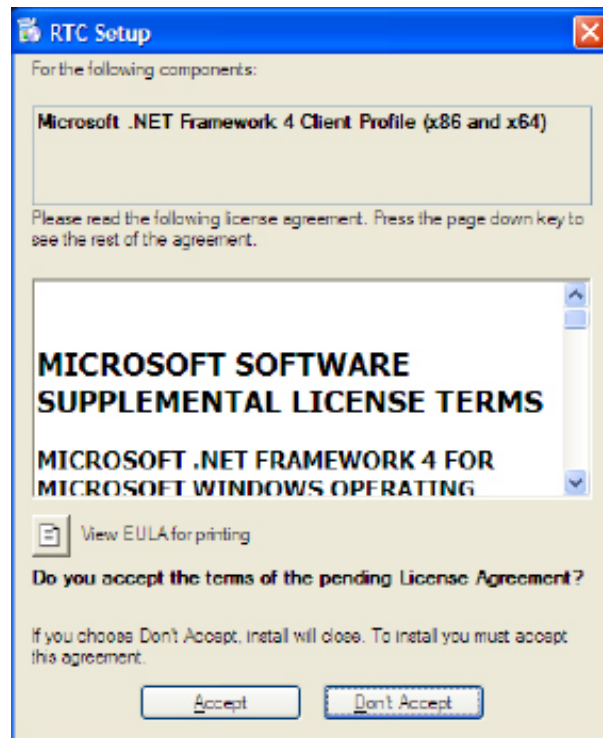

After Framework loads, click 'Yes', on Setup. This will reboot the computer.

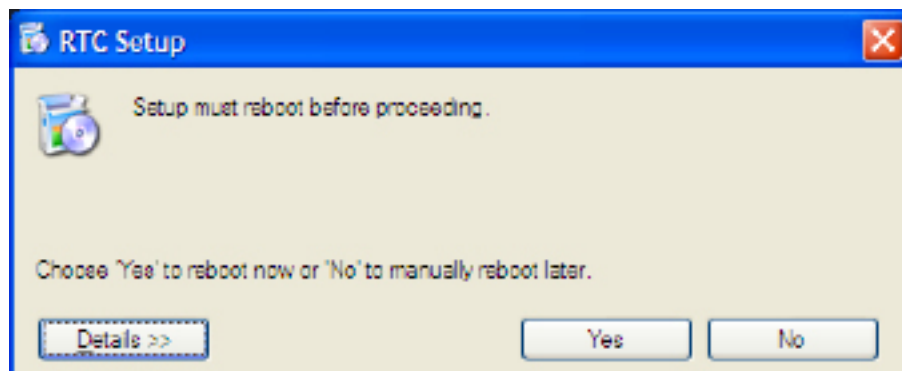

When the 'Welcome to the RTC Setup Wizard' window appears, click 'Next.'

CBC-EVAL-06 EnerChip CC RTC Evaluation Kit

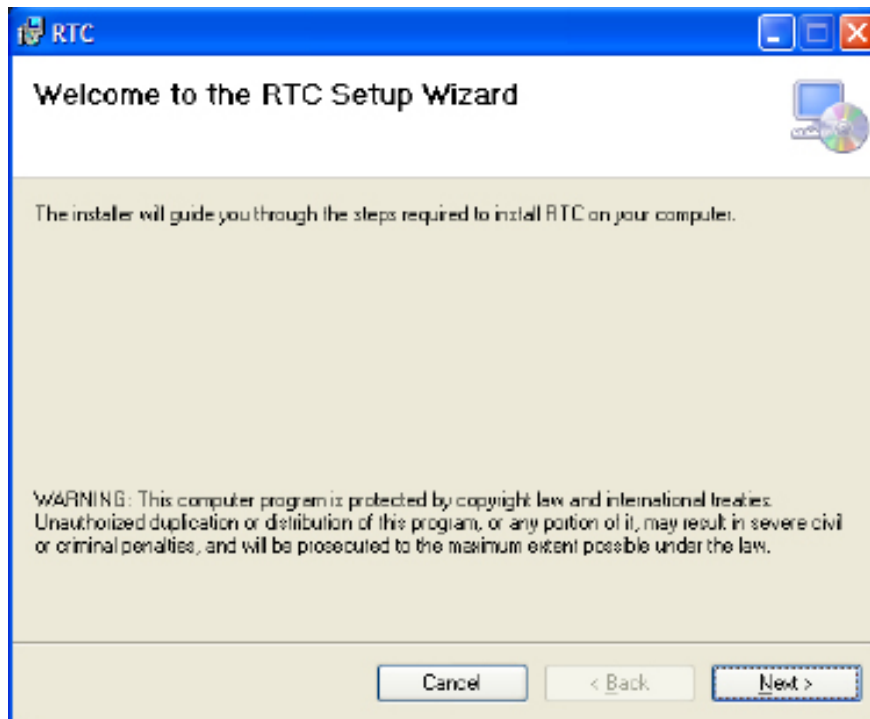

Click 'Next' on each of the next two windows that appear.

Installing RTC ...Installation complete, then click 'Close'

Insert EVAL-06 dongle into USB port. Both red LEDs will be lit

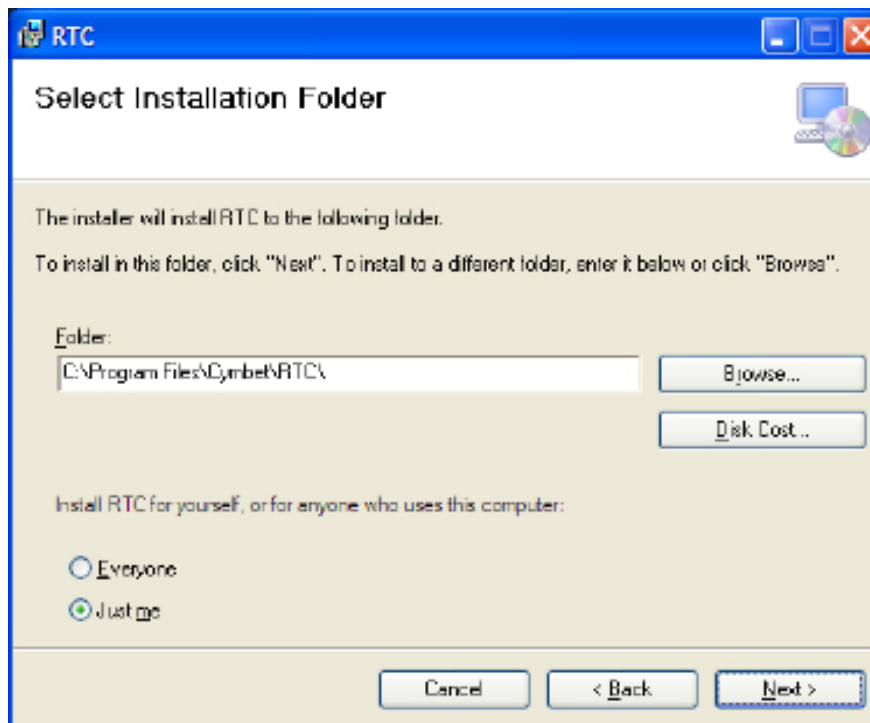

CBC-EVAL-06 EnerChip CC RTC Evaluation Kit

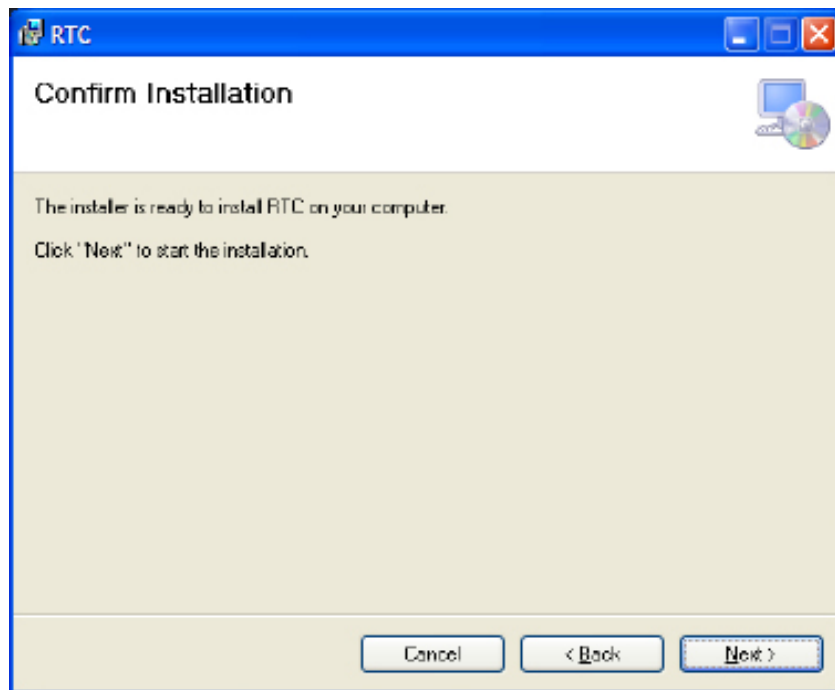

When the 'Found New Hardware Wizard' window appears, click 'No, not this time.'

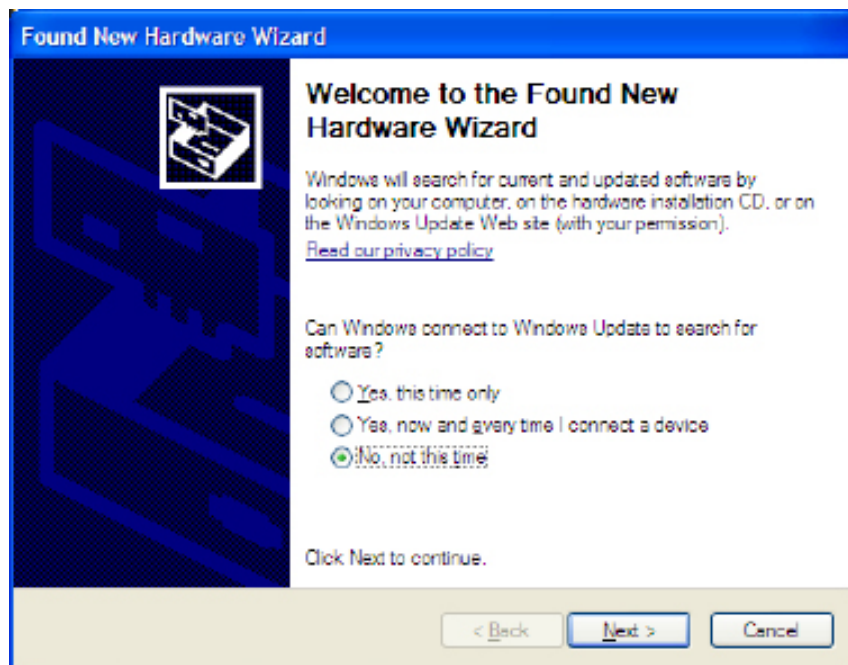

Click 'Next.'

Then, click 'Install from a list or specific location (Advanced)' and click 'Next.'

CBC-EVAL-06 EnerChip CC RTC Evaluation Kit

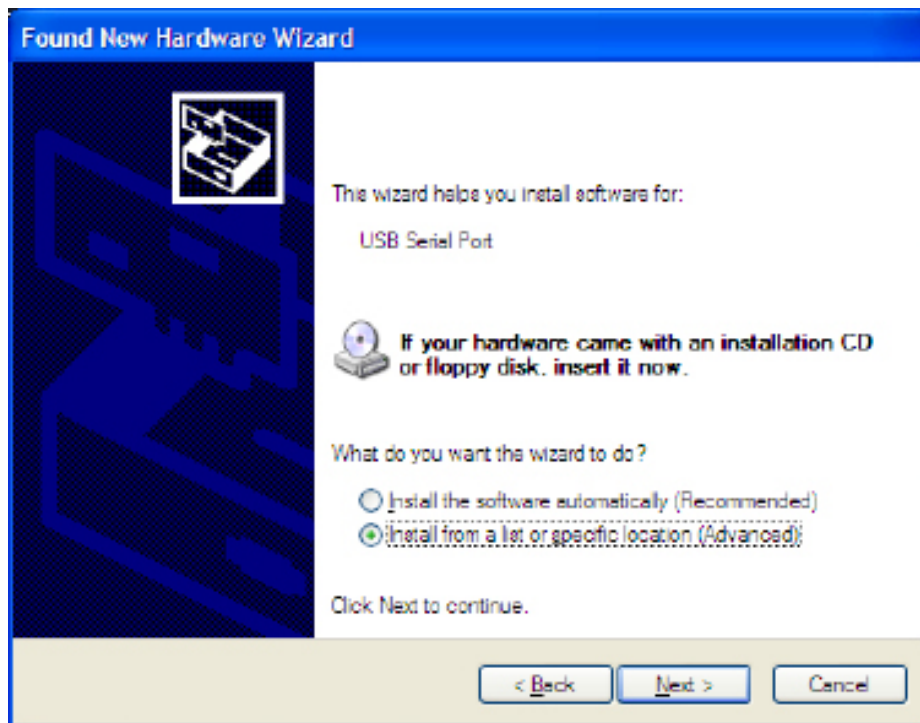

At the next window, check 'Include this location in the search,' then browse to 'My Computer.'

Continue navigating computer folders to the location shown below, then click 'OK' in the 'Browse for Folder' window.

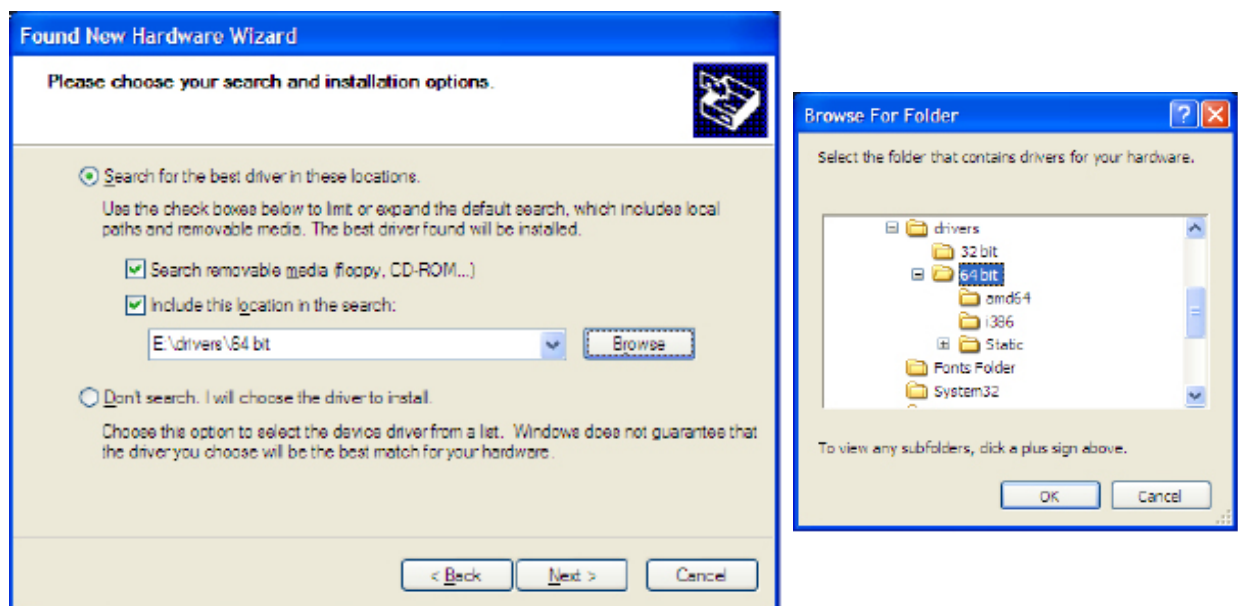

Click 'Next.'

CBC-EVAL-06 EnerChip CC RTC Evaluation Kit

When the 'Found New Hardware Wizard' window appears, Click 'Finish.'

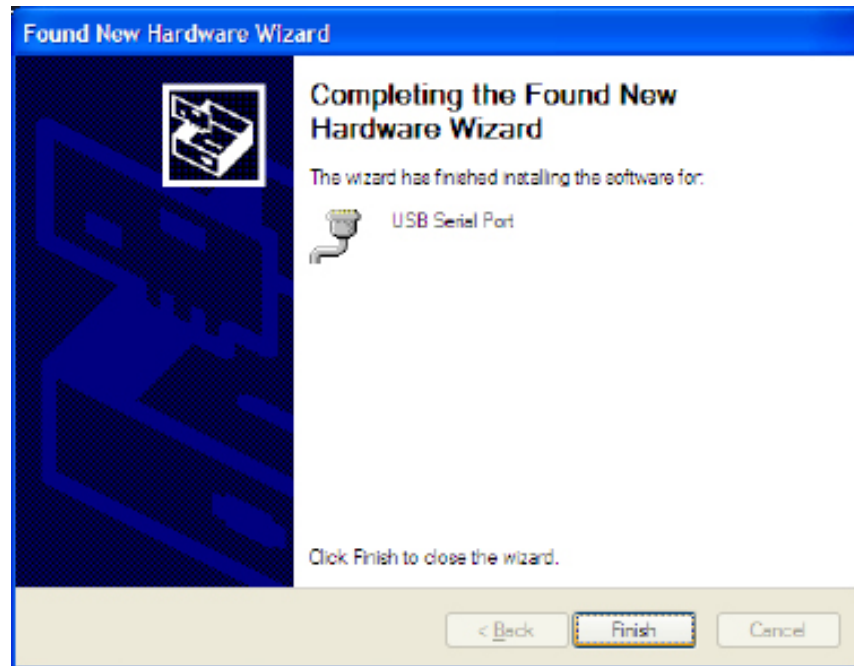

A 'Found New Hardware' balloon will appear on your screen, indicating a successful installation. The system is now ready to run the RTC demo.

CBC-EVAL-06 EnerChip CC RTC Evaluation Kit

Double-click the 'Cymbet RTC Demo' icon on the desktop. The following window should appear.

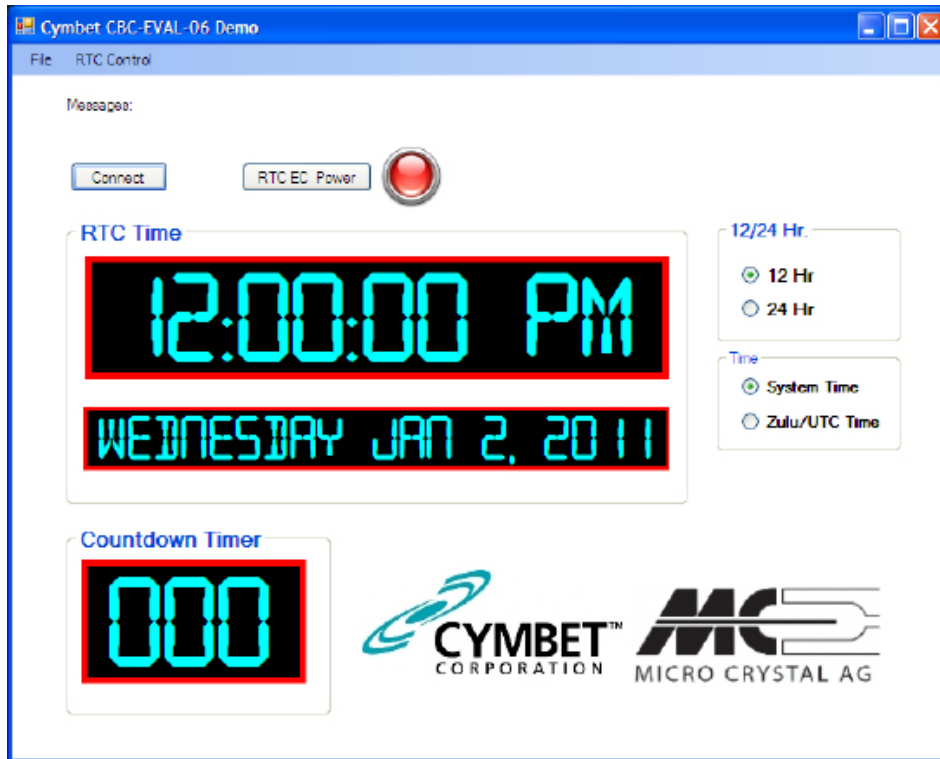

Plug in the EVAL-06 USB stick into a PC USB Port. Click 'Connect' on the Graphical User Interface (GUI). The System time will appear.

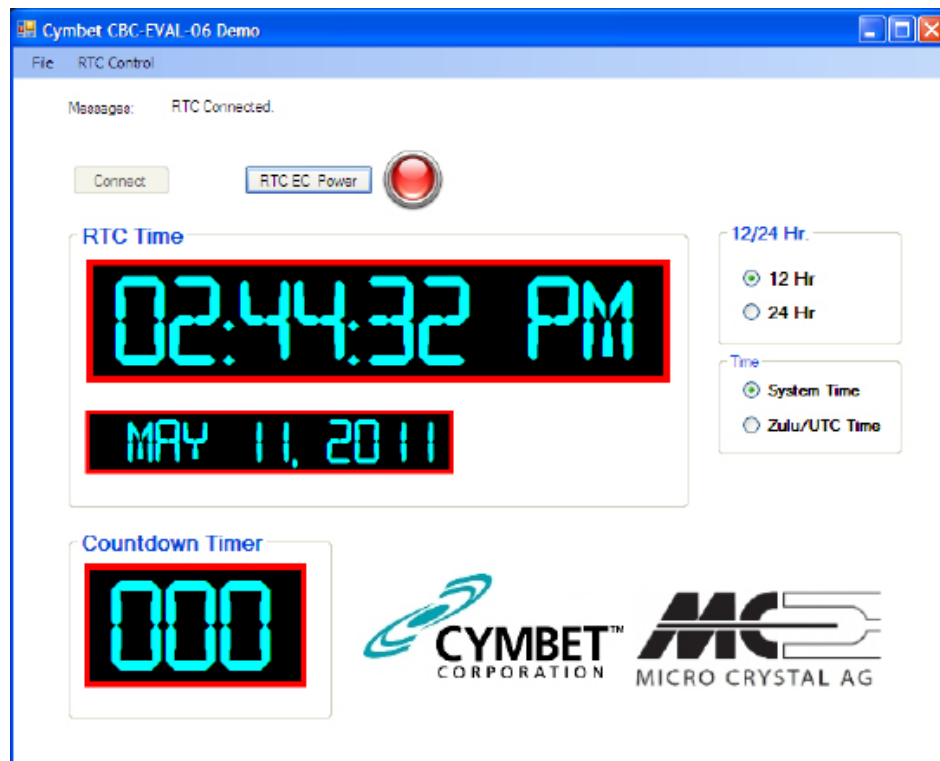

CBC-EVAL-06 EnerChip CC RTC Evaluation Kit

Click 'RTC EC Power' to disable power from the dongle. Power LED will turn off.

Click RTC EC Power to again apply power to the dongle.

To use Countdown Timer or clock settings, open 'RTC Control' menu.

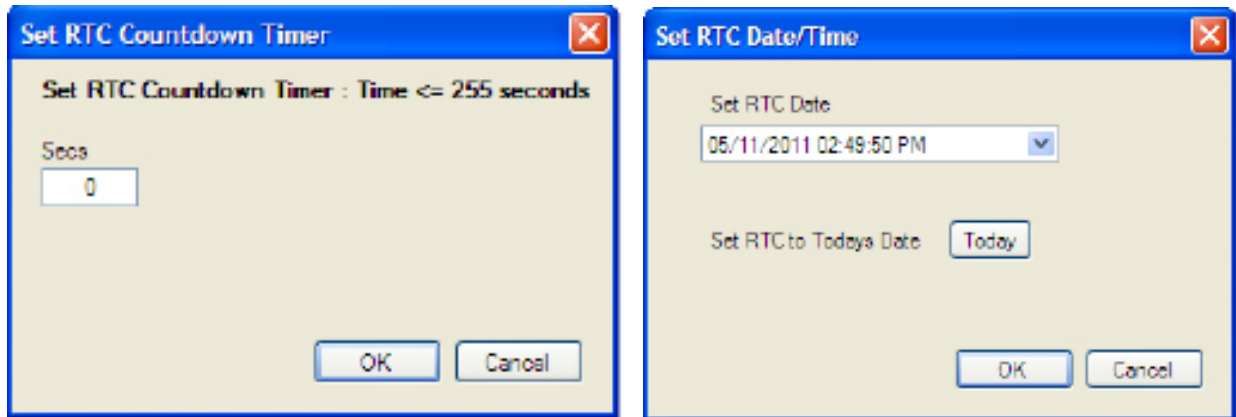

Select either option.

RTC Countdown Timer option allows user to apply a value from 0 to 255 in 'Secs' field.

Alternatively, the 'Set RTC Date/Time' option allows the user to set a specific date and time. Enter any arbitrary date and time as the starting time.

Once countdown timer or date and time have been set, the CBC3112 EnerChip can be used to maintain the timer or time by either disabling power from the dongle by clicking the 'RTC EC Power' button or removing the dongle from the USB port. In the absence of USB power, the CBC3112 will provide power to the RV-2123 RTC for up to 100 hours. Simply re-insert the dongle or re-apply power to verify that the countdown timer or time and date were maintained while the dongle was not under USB power.

CBC-EVAL-06 EnerChip CC RTC Evaluation Kit

CBC-EVAL-06 Circuit Schematic

The schematic of Figure 4 depicts the portion of the CBC-EVAL-06 including the EnerChip CC and the RTC module which is the top side of the USB stick. Note the presence of vias J1 for connecting the components to an external circuit for hardware development.

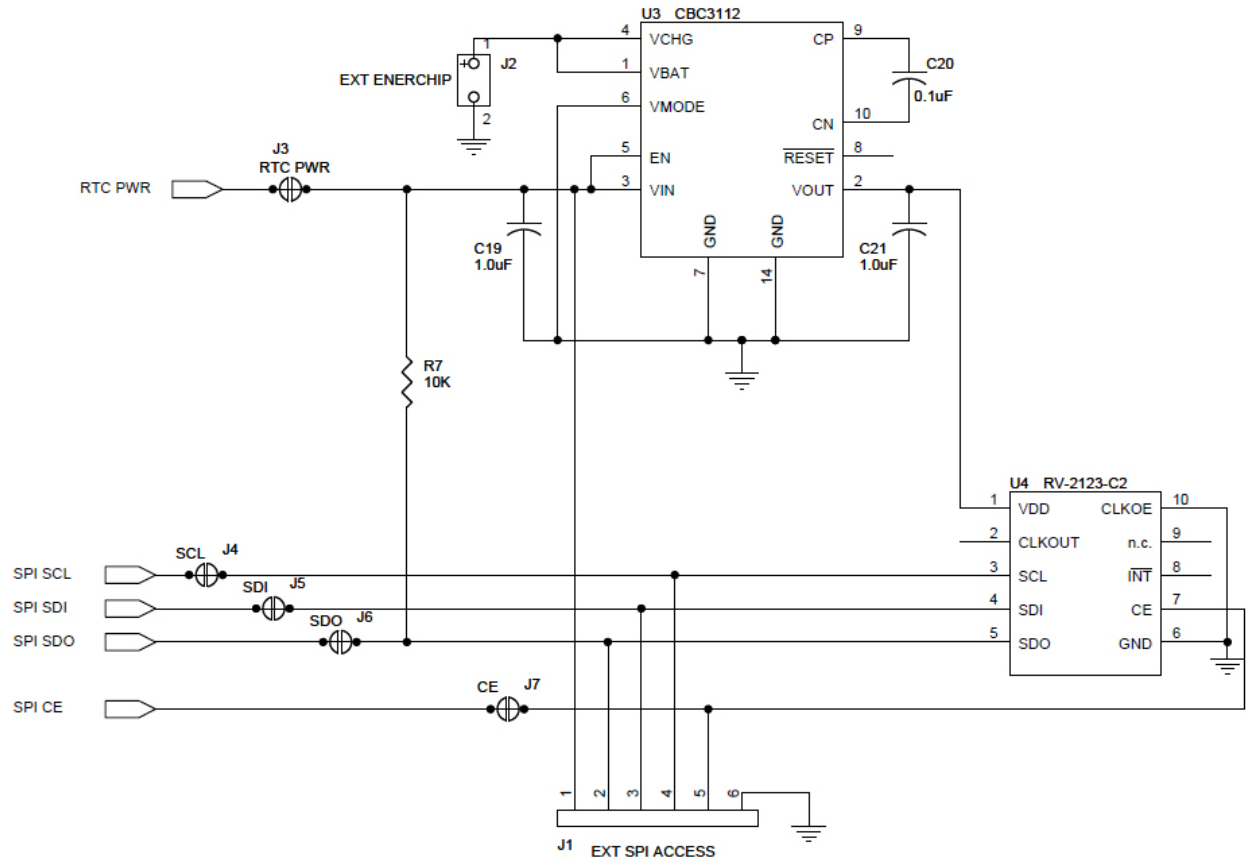

Figure 4: CBC-EVAL-06 Circuit Schematic (EnerChip CC and RTC Portion Only).

Table 1: CBC-EVAL-06 Bill of Materials.

Quantity	Ref Des	Manufacturer	Manufacturer Part #	Description
1	R8	Panasonic - ECG	ERJ-2GE0R00X	RES 0.0 OHM 1/10W 0402 SMD
2	R2,R3	Vishay/Dale	CRCW040227R0JNED	RES 27 OHM 1/16W 5% 0402 SMD
1	R1	Panasonic - ECG	ERJ-2RKF4700X	RES 470 OHM 1/10W 1% 0402 SMD
2	R9,R10	Yageo	RC0402JR-07680RL	RES 680 OHM 1/16W 5% 0402 SMD
1	R4	Vishay/Dale	CRCW04021K50JNED	RES 1.5K OHM 1/16W 5% 0402 SMD
3	R5,R6,R7	Vishay/Dale	CRCW040210K0FKED	RES 10.0K OHM 1/16W 1% 0402 SMD
2	C16,C17	Murata Electronics North America	GRM1555C1H270J201D	CAP CER 27PF 50V 5% C0G 0402
2	C6,C7	Murata Electronics North America	GCM1555C1H470JZ13D	CAP CER 47PF 50V C0G 0402
2	C1,C13	Murata Electronics North America	GCM155R71H103KA55D	CAP CER .01UF 50V X7R 0402
2	C5,C12	Murata Electronics North America	GRM155R71A333KA01D	CAP CER 33000PF 10V 10% X7R 0402
6	C2,C4,C11,C14,C15,C20	Murata Electronics North America	GRM155R61A104KA01D	CAP .1UF 10V CERAMIC X5R 0402
2	C19,C21	Murata Electronics North America	GRM155R60J105KE19D	CAP CER 1.0UF 6.3V 10% X5R 0402
1	C3	TDK Corporation	C1508X5R0J106M	CAP CER 10UF 6.3V X5R 0603
2	D3,D4	Lumex Opto/Components Inc	SML-LX06031W-TR	LED 635NM RED DIFF 0603 SMD
1	U2	FTDI, Future Technology Devices Int'l Ltd	FT2232D-REEL	IC USB FS DUAL UART/FIFO 48-LQFP
1	U3	Cymbet	CBC3112	EnerChip CC CBC3112
1	U4	Microcrystal	RV-2123-C2	IC RTC MODULE
1	Q1	Diodes Inc	DMP2004VK	MOSFET P-CH DUAL 530MA SOT-563
2	FB1,FB2	Murata Electronics North America	BLM15BD182SN1D	FERRITE CHIP 1800 OHM 100MA 0402
1	Y1	Fox Electronics	FQ7050B-6	CRYSTAL 6.0000 MHZ 20PF SMT
1	CN1	Molex Inc	480371000	CONN PLUG USB 4POS RT ANG SMD
1	PCB1	Cymbet	310079 REV. A	PRINTED CIRCUIT BOARD

CBC-EVAL-06 EnerChip CC RTC Evaluation Kit

CBC-EVAL-06 Assembly Diagrams

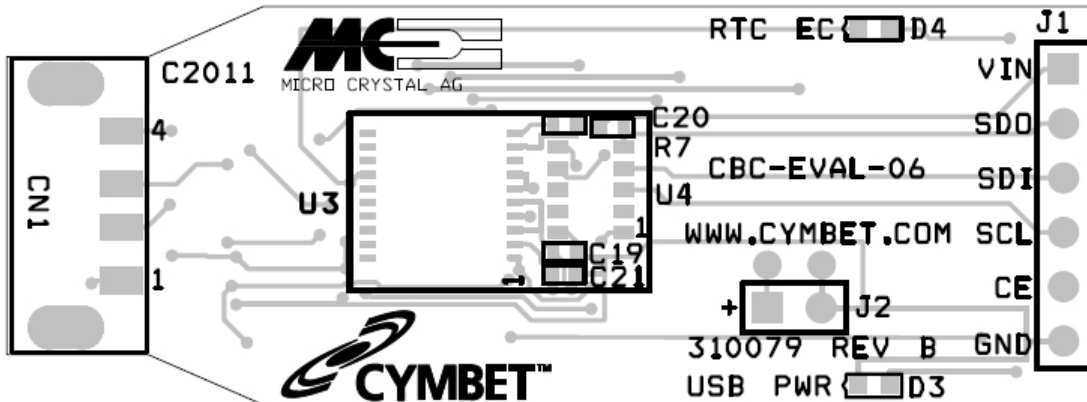

Figure 5: CBC-EVAL-06 Assembly Diagram (Top View).

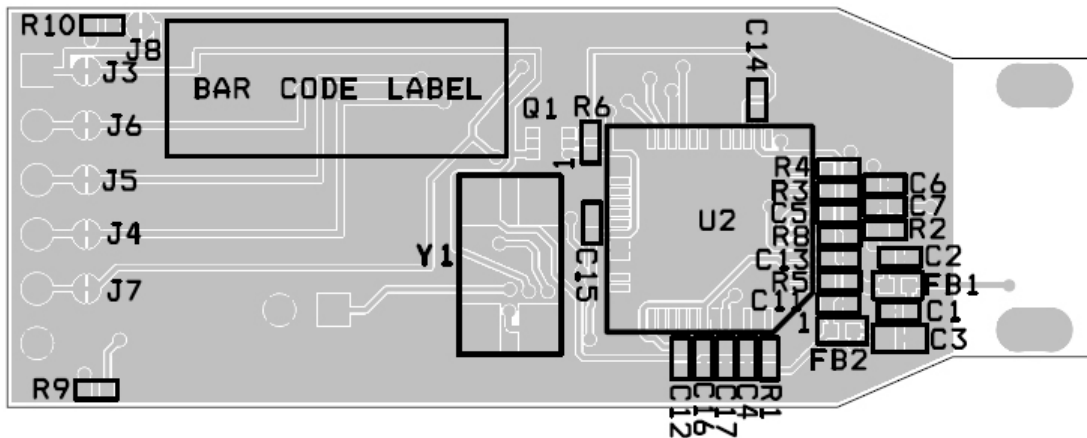

Figure 6: CBC-EVAL-06 Assembly Diagram (Bottom View).

Ordering Information

EnerChip Part Number	Description	Notes
CBC-EVAL-06	EnerChip CC RTC Demo Kit	Contains USB Stick with EnerChip CC and RTC Module
CBC3112-D7C	EnerChip CC with Integrated Power Management	Packaged in Tape and Reel or Tubes
CBC012-D5C	EnerChip 12µAh Solid State Battery	Packaged in Tape and Reel or Tubes

Disclaimer of Warranties; As Is

The information provided in this data sheet is provided "As Is" and Cymbet Corporation disclaims all representations or warranties of any kind, express or implied, relating to this data sheet and the Cymbet battery product described herein, including without limitation, the implied warranties of merchantability, fitness for a particular purpose, non-infringement, title, or any warranties arising out of course of dealing, course of performance, or usage of trade. Cymbet battery products are not approved for use in life critical applications. Users shall confirm suitability of the Cymbet battery product in any products or applications in which the Cymbet battery product is adopted for use and are solely responsible for all legal, regulatory, and safety-related requirements concerning their products and applications and any use of the Cymbet battery product described herein in any such product or applications.

**Cymbet, the Cymbet Logo and EnerChip are trademarks of Cymbet Corporation. All Rights Reserved.
EnerChip products and technology are covered by one or more patents or patents pending.**