

Data sheet | Item number: 770-123

Socket; with strain relief housing; 3-pole; Cod. A; 4,00 mm²; white

www.wago.com/770-123



Subject to changes. Please also observe the further product documentation!

WAGO GmbH & Co. KG
Hansastr. 27
32423 Minden
Phone: +49571 887-0 | Fax: +49571 887-169
Email: info.de@wago.com | Web: www.wago.com

Do you have any questions about our products?
We are always happy to take your call at +49 (571) 887-44222.

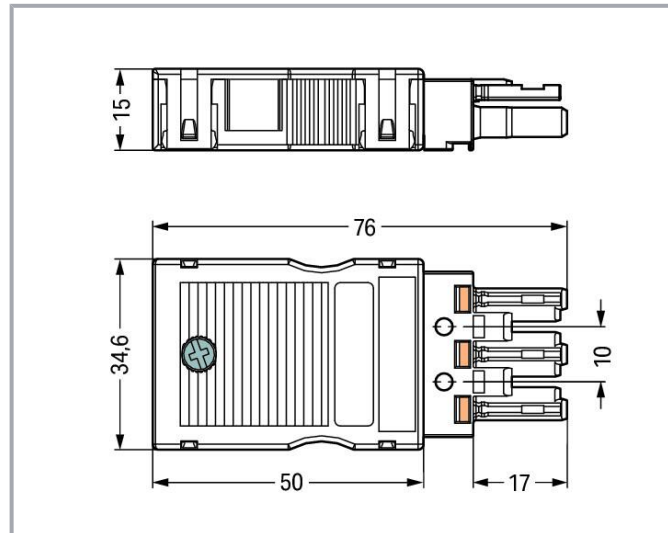
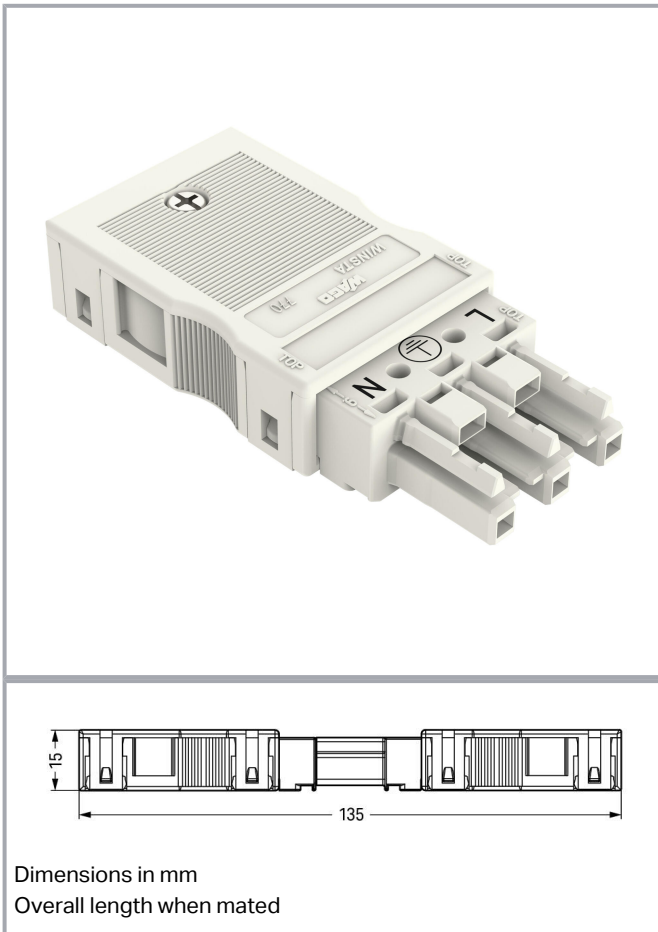

Item description

Female connector/socket WINSTA® MIDI with protection against mismatching

Use effective pluggable connections instead of laborious screw connections: With the WINSTA® MIDI female connector/socket A coding. Whether on PCBs, in control cabinets or for connecting lights – pluggable installation connectors from WAGO allow you to establish connections according to a huge variety of requirements in seconds. The mechanical coding and color coding of the pluggable installation connector ensure error-free installation of the individual components – including protection against mismatching. Thanks to the color coding and mechanical A coding of WINSTA® MIDI pluggable installation connectors, you can clearly distinguish different circuits. Important parameters in the selection of a pluggable installation connector are the rated current and voltage: They tell us about the product's domains of use. This product has a current rating of 25 A – as a result it is suitable for high power loads. The WINSTA® MIDI product line achieves maximum flexibility for the electrical installation. With its Push-in CAGE CLAMP® spring pressure connection technology, it achieves time-saving, error-free installation and offers flexibility for meeting all installation requirements. A range up to 55 mm can be used for the strip length.

Subject to changes. Please also observe the further product documentation!



Push-in CAGE CLAMP® spring pressure connection technology – pluggable installation instead of laborious screw connections!

The WINSTA® Pluggable Connection System is perfectly tailored to the strict requirements of building installation. It makes electrical installation pluggable, and therefore more efficient, even more reliable, and error-free. Use of this pre-assembled system decreases time spent on assembly and errors during installation at the construction site. Take advantage of the pluggable version of our maintenance-free spring pressure connection technology too! Plan your installation with WINSTA® MIDI pluggable installation connectors with marking from WAGO.

- protection against mismatching eliminates errors
- for automation controllers
- for any mains application
- ready to install and use immediately
- convenient installation and commissioning

Data

Electrical data

Ratings per IEC/EN

Ratings per	IEC/EN 60664-1
Nominal voltage (III/3)	250 V
Rated impulse voltage (III/3)	4 kV
Rated current	25 A
Legend (ratings)	(III / 3) ≙ Overvoltage category III / Pollution degree 3

Ratings per UL 1977

Note for the US market	Some versions may also be used for current interruption in accordance with the UL certificate in select applications with currents below 16 A and voltages up to 600 V. For further information, please contact your local sales office.
Rated voltage (UL 1977)	600 V
Rated current UL 1977	23 A

General

Note on contact resistance	approx. 1 mΩ of contact resistance approx. 0.25 mΩ contact transition plug/socket
----------------------------	--

Subject to changes. Please also observe the further product documentation!



Connection data

Connection points	6
Total number of potentials	3

Connection 1

Connection technology	Push-in CAGE CLAMP®
Actuation type	Operating tool Push-in
Nominal cross-section	4 mm ² / 12 AWG
Solid conductor	0.5 ... 4 mm ² / 20 ... 12 AWG
Solid conductor; push-in termination	1.5 ... 4 mm ² / 16 ... 12 AWG
Stranded conductor	0.5 ... 2.5 mm ² / 20 ... 14 AWG
Fine-stranded conductor	0.5 ... 4 mm ² / 20 ... 12 AWG
Fine-stranded conductor; with insulated ferrule	0.25 ... 1.5 mm ² / 20 ... 16 AWG
Fine-stranded conductor; with uninsulated ferrule	0.25 ... 2.5 mm ² / 20 ... 14 AWG
Fine-stranded conductor; with ferrule; push-in termination	1.5 mm ² / 16 AWG
Strip length	9 mm / 0.35 inches
Pole number	3
Connectable sheathed cable diameter	8 ... 11.5 mm
Conductor entry direction to mating direction	0°
Strip length (outer insulation)	55 mm

Physical data

Pin spacing	10 mm / 0.394 inches
Width	34.6 mm / 1.362 inches
Height	15 mm / 0.591 inches
Depth	76 mm / 2.992 inches

Mechanical Data

Application	General mains applications
Coding	A
Variable coding	Yes
Marking	L \perp N
Potential marking	L \perp N
Mating force of a plug-in connection	approx. 20 ... 70 N (depending on pole number)
Retention force of a plug-in connection	Locked: > 80 N

Subject to changes. Please also observe the further product documentation!



Unmating force of a plug-in connection	Unlocked: approx. 20 ... 70 N (depending on pole number)
Number of mating cycles	200, without resistive load
Protection type	IP2XC; When mated and secured with a strain relief housing: IP2xC (These compact connectors are not designed for use in open, easily accessible areas!)

Plug-in connection

Contact type (pluggable connector)	Female connector/socket
Connector (connection type)	for conductor
Mismating protection	Yes
Note on mismating protection	All <i>WINSTA</i> [®] components are 100% protected against mismating when: a.) plugging different numbers of poles b.) plugging while rotated 180 c.) plugging while laterally staggered d.) plugging one pole
Locking lever	Can be retrofitted
Locking of plug-in connection	locking lever
Note on locking system	All connectors for mounted installations (snap-in versions for lighting fixtures or devices, all types of PCB and distribution connectors) are factory-equipped with locking levers to ensure plugs and sockets are securely locked. Additional locking levers are only required for flying leads (plug/socket).
Strain relief	strain relief housing

Material Data

Note (material data)	Information on material specifications can be found here
Color	white
Cover color	gray
Material group	I
Insulation material	Polyamide (PA66)
Flammability class per UL94	V0
Clamping spring material	Chrome-nickel spring steel (CrNi)
Contact material	Copper or copper alloy; surface-treated
Contact plating	Tin
Fire load	0.436 MJ
Strain relief color	white
Weight	19.7 g

Subject to changes. Please also observe the further product documentation!

Environmental requirements

Processing temperature	-5 ... +40 °C
Continuous operating temperature	-35 ... +85 °C
Note on continuous operating temperature	Insulating parts for temperatures ≤ 105 °C

Commercial data



Product Group	20 (Winsta)
eCl@ss 10.0	27-44-06-05
eCl@ss 9.0	27-44-06-05
ETIM 8.0	EC002560
ETIM 7.0	EC002560
PU (SPU)	25 pcs
Packaging type	box
Country of origin	DE
GTIN	4044918252171
Customs tariff number	85366990990

Environmental Product Compliance

RoHS Compliance Status	Compliant, No Exemption
------------------------	-------------------------

Approvals / Certificates

General approvals

Logo	Approval	Additional Approval Text	Certificate name
	CCA DEKRA Certification B.V.	EN 61535	71-123228
	CCA DEKRA Certification B.V.	IEC 61535	NL-84761
	cURus Underwriters Laboratories Inc.	UL 1977	E45171
	VDE VDE Prüf- und Zertifizierungsinstitut	EN 61535	40029808

Subject to changes. Please also observe the further product documentation!



VDE
VDE Prüf- und Zertifizierungsinstitut



EN 61984

40002889



Declarations of conformity and manufacturer's declarations

Logo	Approval	Additional Approval Text	Certificate name
	EU-Declaration of Conformity WAGO GmbH & Co. KG	-	-

Approvals for marine applications

Logo	Approval	Additional Approval Text	Certificate name
	ABS American Bureau of Shipping	-	19- HG1868589- PDA
	DNV GL Det Norske Veritas, Germanischer Lloyd	-	TAE00001Z6
	LR Lloyds Register	IEC 61984	LR22429487TA

Counterpart

	Item no.770-133 Plug; with strain relief housing; 3-pole; Cod. A; 4,00 mm ² ; white	www.wago.com/770-133
	Item no.770-233 Plug; 3-pole; Cod. A; 4,00 mm ² ; white	www.wago.com/770-233
	Item no.770-233/002-000 Plug; with direct ground contact; 3-pole; Cod. A; 4,00 mm ² ; white	www.wago.com/770-233/002-000

Subject to changes. Please also observe the further product documentation!

WAGO GmbH & Co. KG
Hansastr. 27
32423 Minden
Phone: +49571 887-0 | Fax: +49571 887-169
Email: info.de@wago.com | Web: www.wago.com

Do you have any questions about our products?
We are always happy to take your call at +49 (571) 887-44222.



Item no.770-233/035-050
Plug; with strain relief housing; 3-pole; Cod. A; 4,00 mm²; white

www.wago.com/770-233/035-050



Item no.770-656
T-distribution connector; 3-pole; Cod. A; 1 input; 2 outputs; 2 locking levers; white

www.wago.com/770-656



Item no.770-6223
Linect® T-connector; 3-pole; Cod. A; 1 input; 2 outputs; white

www.wago.com/770-6223



Item no.770-657
3-way distribution connector; 3-pole; Cod. A; 1 input; 3 outputs; white

www.wago.com/770-657



Item no.770-658
5-way distribution connector; 3-pole; Cod. A; 1 input; 5 outputs; white

www.wago.com/770-658



Item no.770-665
T-distribution connector; 3-pole; Cod. A; 1 input; 2 outputs; 3 locking levers; for flying leads; white

www.wago.com/770-665



Item no.770-685
h-distribution connector; 3-pole; Cod. A; 1 input; 2 outputs; outputs on both sides; 3 locking levers; for flying leads; white

www.wago.com/770-685



Item no.770-686
h-distribution connector; 3-pole; Cod. A; 1 input; 2 outputs; outputs on one side; 3 locking levers; for flying leads; white

www.wago.com/770-686



Item no.770-683
h-distribution connector; 3-pole; Cod. A; 1 input; 2 outputs; outputs on both sides; 2 locking levers; white

www.wago.com/770-683



Item no.770-684
h-distribution connector; 3-pole; Cod. A; 1 input; 2 outputs; outputs on one side; 2 locking levers; white

www.wago.com/770-684



Item no.770-687
Distribution connector for switches; Single-pole switch and series circuit; 3-pole; Cod. A/S; 1 input; 5 outputs; white

www.wago.com/770-687

Item no.770-688

Subject to changes. Please also observe the further product documentation!



Distribution connector for switches; Single-pole and throttle two-way circuit; 3-pole; Cod. A/S; 1 input; 5 outputs; white

www.wago.com/770-688



Item no.770-733/007-000
Snap-in plug; with direct ground contact; 3-pole; Cod. A; 4,00 mm²; white

www.wago.com/770-733/007-000



Item no.770-733
Snap-in plug; 3-pole; Cod. A; 4,00 mm²; white

www.wago.com/770-733



Item no.770-833
Plug for PCBs; straight; 3-pole; Cod. A; white

www.wago.com/770-833



Item no.771-9993/006-102
pre-assembled interconnecting cable; Eca; Socket/plug; 3-pole; Cod. A; H05VV-F 3G 1.5 mm²; 1 m; 1,50 mm²; white

www.wago.com/771-9993/006-102



Item no.770-833/011-000
Plug for PCBs; angled; 3-pole; Cod. A; white

www.wago.com/770-833/011-000

Required accessories

Locking levers

Locking system



Item no.: 770-121
Locking lever; for flying leads; for manual operation; white

www.wago.com/770-121



Item no.: 770-131
Locking lever; for flying leads; for tool operation; white

www.wago.com/770-131



Item no.: 770-101
Locking lever; for flying leads; for manual operation; black

www.wago.com/770-101



Item no.: 770-111
Locking lever; for flying leads; for tool operation; black

www.wago.com/770-111

Optional accessories

Cover

Cover

Subject to changes. Please also observe the further product documentation!



Item no.: 770-201

Lockout cap; 12-pole, separable; for sockets; Plastic; black

www.wago.com/770-201



Item no.: 770-221

Lockout cap; 12-pole, separable; for sockets; Plastic; white

www.wago.com/770-221

Marking accessories

Marker



Item no.: 770-450/000-002

Marker card; Plastic; yellow

www.wago.com/770-450/000-002



Item no.: 770-450/000-001

Marker card; Plastic; green

www.wago.com/770-450/000-001



Item no.: 770-450/000-005

Marker card; Plastic; red

www.wago.com/770-450/000-005



Item no.: 770-450

Marker card; Plastic; white

www.wago.com/770-450



Item no.: 770-450/000-006

Marker card; Plastic; blue

www.wago.com/770-450/000-006



Item no.: 770-450/000-012

Marker card; Plastic; orange

www.wago.com/770-450/000-012

Tool

Operating tool



Item no.: 210-719

Operating tool; Blade: 2.5 x 0.4 mm; with a partially insulated shaft

www.wago.com/210-719



Item no.: 770-383

Operating tool; 3-way; green

www.wago.com/770-383

Subject to changes. Please also observe the further product documentation!

WAGO GmbH & Co. KG

Hansastr. 27

32423 Minden

Phone: +49571 887-0 | Fax: +49571 887-169

Email: info.de@wago.com | Web: www.wago.com

Do you have any questions about our products?

We are always happy to take your call at +49 (571) 887-44222.



Downloads

Documentation

Bid Text

770-123 X81 - Datei	2019 Feb 19	xml 3.1 kB	Download
770-123 doc - Datei	2015 Jun 8	doc 24.1 kB	Download
ausschreiben.de 770-123		URL	Download

CAD/CAE-Data

CAD data

2D/3D Models 770-123		URL	Download
----------------------	--	-----	----------

CAE data

EPLAN Data Portal 770-123		URL	Download
WSCAD Universe 770-123		URL	Download
ZUKEN Portal 770-123		URL	Download

Environmental Product Compliance

Compliance Search

Environmental Product Compliance 770-123 Socket; with strain relief housing; 3-pole; Cod. A; 4,00 mm ² ; white		URL	Download
--	--	-----	----------

Installation Notes

Conductor termination

Subject to changes. Please also observe the further product documentation!

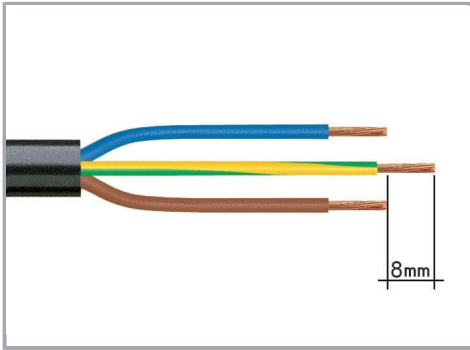

1. Strip length, outer insulation = 35 mm (2-pole), 55 mm (3- to 5-pole)
2. Strip length = 9 mm
3. Extended ground conductor = 8 mm

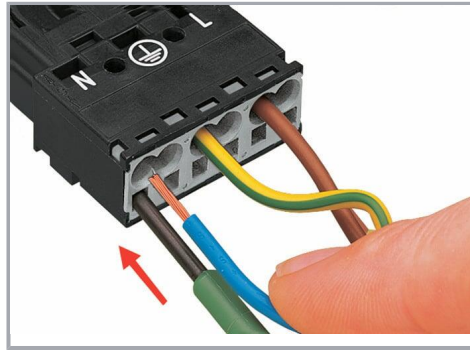

To terminate fine-stranded conductors, open the clamping unit via screwdriver (2.5 mm blade width) and insert a stripped conductor until it hits the backstop.

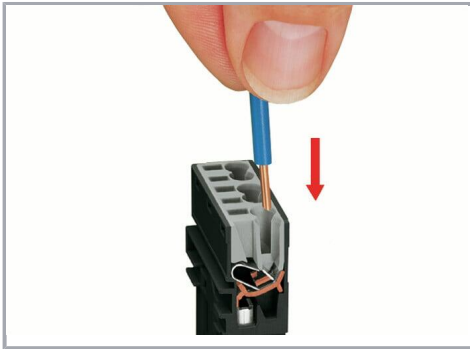

Insert the stripped solid conductor until it hits the backstop.

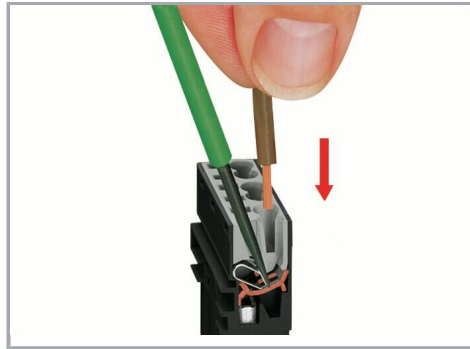

To terminate fine-stranded conductors, open the clamping unit via screwdriver (2.5 mm blade width) and insert a stripped conductor until it hits the backstop.

Conductor removal

Subject to changes. Please also observe the further product documentation!

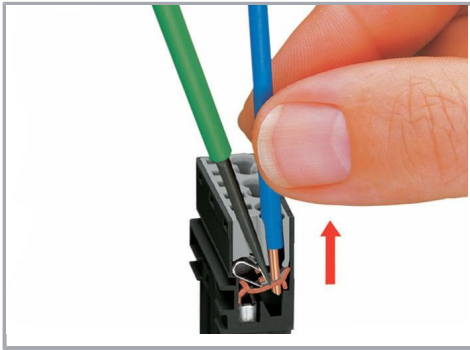

To remove the conductor, actuate the clamp via screwdriver (2.5 mm blade width) and pull out the conductor.

Installation

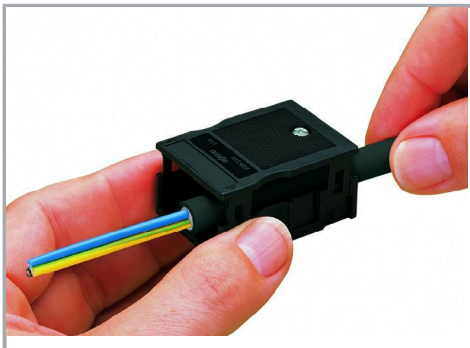

We recommend pulling the pre-latched strain relief housing over the cable prior to termination. However, the strain relief can be mounted at a later time as well.

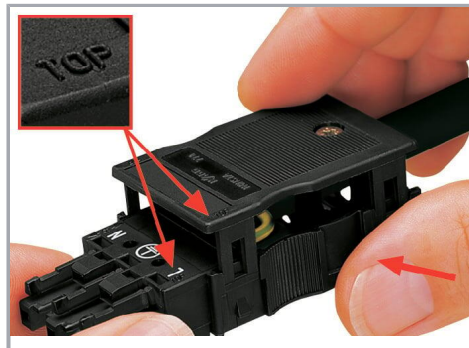

Latch the strain relief housing onto the plug /socket. Note the "TOP" inscription.

Subject to changes. Please also observe the further product documentation!

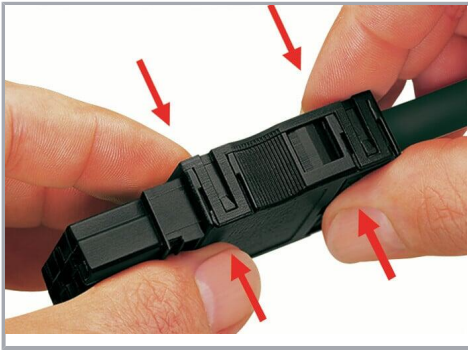

Prepare strain relief housing by snapping together upper and bottom part.



Tighten strain relief screw with screwdriver (2.5 mm blade width).

Coding



Simply cut off the coding pin from the socket.

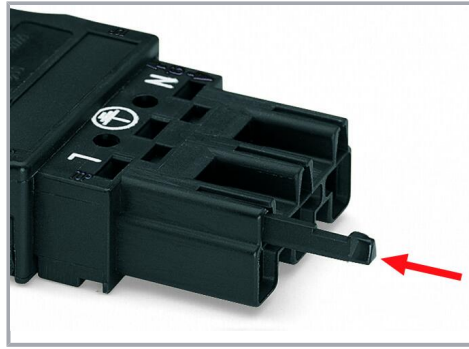

Insert coding pin into plug (break first) until it engages.

Shield termination

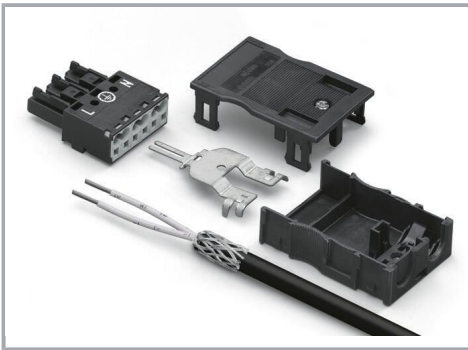

Connector with shield termination

Subject to changes. Please also observe the further product documentation!

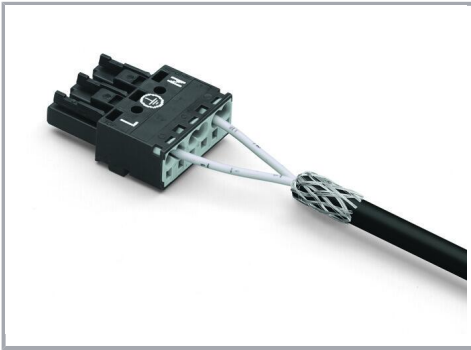

Apply the shield to the sheathed cable.

Strip length, outer insulation = 55 mm

Shield length = 10 mm

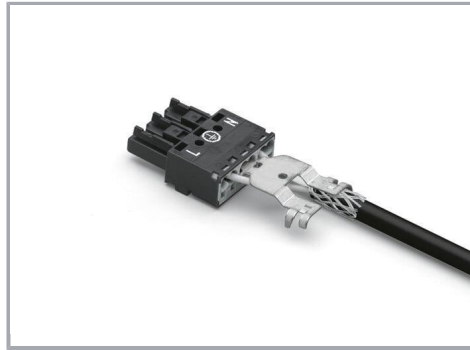

Push the shield connecting plate into the connector until fully inserted.

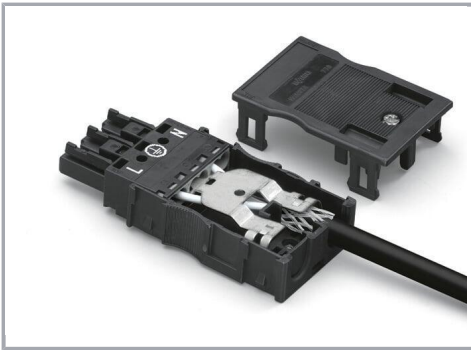

First insert the wired connector into a strain relief housing, then snap cover and tighten screw.

Product family

WINSTA® MIDI

[Show all products from the family](#)

Subject to changes. Please also observe the further product documentation!