

Safety Control Unit NX-SL3/SL5/SI/SO

**The simplest way to integrate safety into ultra-flexible, ultra-high-speed machine automation -
Bring safety to your production site**



For the most recent information on models that have been certified for safety standards, refer to your OMRON website.

- Automatic generation, from safety programs through to safety functional test reports
- Data logging with fast cycle time to detect causes of downtime and degradation of safety components
- Integrated safety to EtherNet/IP™ for safety communication between machines
- Integrated safety over EtherCAT® for high-speed, high-precision fieldbus communication in a machine
- Easy to set up motion and robots that are the key to quality and productivity enhancement

Features

- Meets EN ISO 13849-1 (PLe/Safety Category 4) and IEC 61508 (SIL3)
- CIP Safety™ allows standard devices and safety devices to be mixed on the same EtherNet/IP™ network
- Safety over EtherCAT (FSoE) allows standard devices and safety devices to be mixed on the same EtherCAT® network
- Reusable safety program POU's according to IEC 61131-3 make programming more efficient
- PLCopen® Function Blocks for Safety reduce time and cost to learn safety design
- Safety I/O wiring diagrams, safety circuit programs, and user-defined Function Blocks can be automatically generated, minimizing safety design errors
- Simple Automatic Test using Offline Simulation is available. Online Functional Test ensures and maintains safety during machine commissioning and operation



EtherNet/IP™ is a widely used and vendor-independent industrial Ethernet network that is managed by ODVA.



The Common Industrial Protocol (CIP™) is an industry standard open network, enabling seamless communication among CIP networks. CIP Safety™ adds safety functionality to CIP networks.



EtherCAT® is an industrial real-time communication network promoted by EtherCAT Technology Group (ETG).



Safety over EtherCAT (FSoE) allows a single communication system to be used for both control and safety data.

Trademarks

- Sysmac is a trademark or registered trademark of OMRON Corporation in Japan and other countries for OMRON factory automation products.
- Microsoft, Windows, Windows Vista, Excel, and Visual Basic are registered trademarks of Microsoft Corporation in the United States and other countries.
- EtherCAT® is registered trademark and patented technology, licensed by Beckhoff Automation GmbH, Germany.
- Safety over EtherCAT® is registered trademark and patented technology, licensed by Beckhoff Automation GmbH, Germany.
- ODVA, CIP™, CompoNet™, DeviceNet™, EtherNet/IP™, and CIP Safety™ are trademarks of ODVA.
- PLCopen® and related logo are registered trademarks of PLCopen®.
- The SD and SDHC logos are trademarks of SD-3C, LLC.

Other company names and product names in this document are the trademarks or registered trademarks of their respective companies.

NX-SL3/SL5/SI/SO



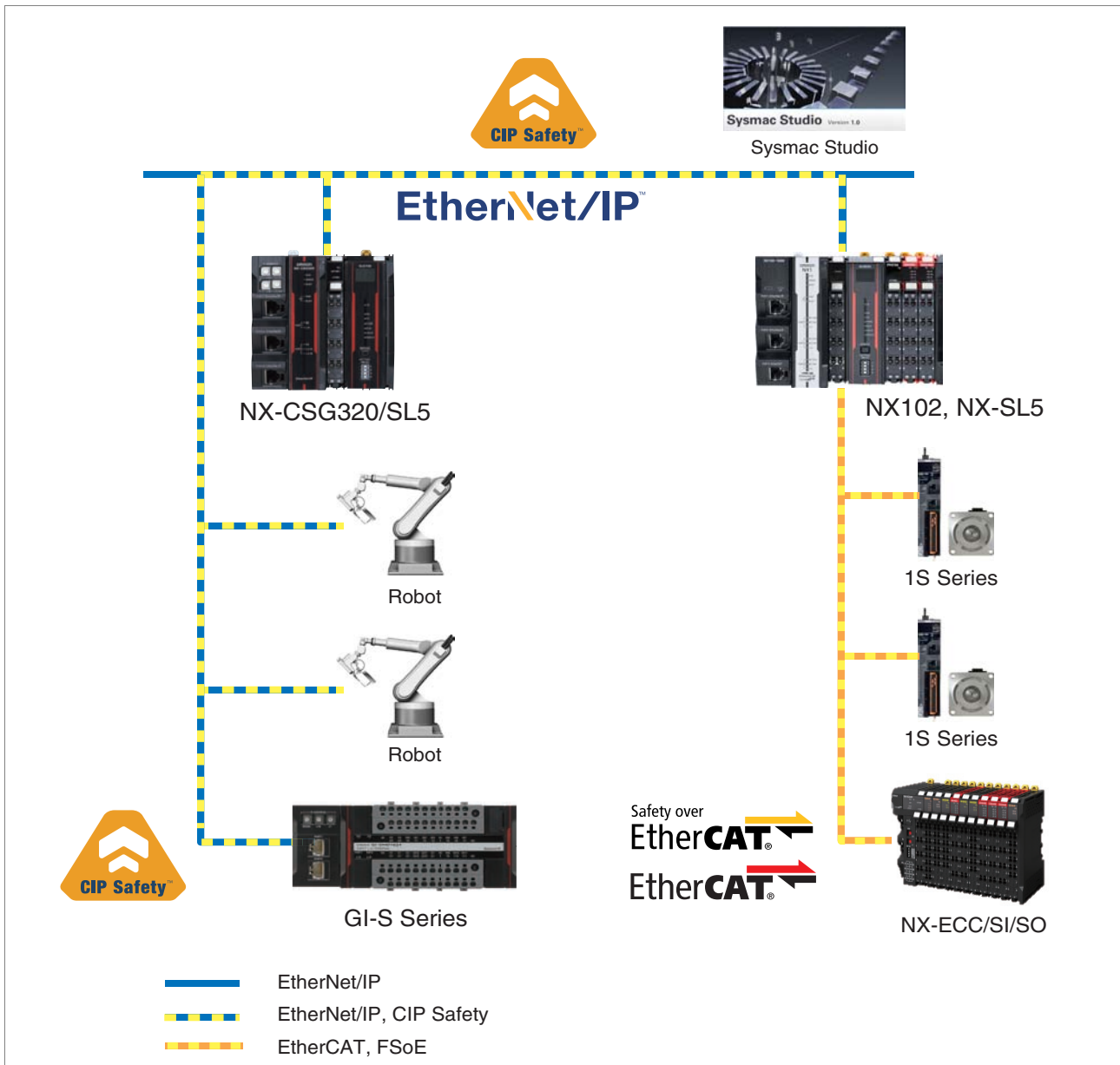

System configuration

Machine controller	NX102		NJ1/3/5 series, NX1P, NX7
Safety CPU unit	NX-SL5500 NX-SL5700	NX-SL3300 NX-SL3500	
System overview	Integrated safety of internal high-speed high-precision fieldbus and industrial Ethernet between instruments is realized	Enables both high-speed high-precision control and safety control	
Standard network	EtherNet/IP, EtherCAT		
Safety network	FSoE, CIP Safety	FSoE(Safety over EtherCAT)	
Number of safety I/O connections	NX-SL5500: Max. 128 NX-SL5700: Max. 254	NX-SL3300: Max. 32 NX-SL3500: Max. 128	
Safety motion	Connectable with 1S series		
Safety communication with robots	Connectable	Not connectable	
Safety data logging without tools	Supported	Not supported	
Common safety functions	<ul style="list-style-type: none"> • Automatic generation of safety I/O wiring diagram • Automatic generation of safety circuit program • Automatic generation of user definition function block • Offline simulation function and quick automatic test • Online safety function test 		
System configuration	System configuration diagram A (page 2)	System configuration diagram B (page 3)	System configuration diagram C (page 3)

System configuration A (NX102+SL5)



List of global standards

Safety certification standards		<ul style="list-style-type: none"> • EN ISO 13849-1 • EN ISO 13849-2 • IEC 61508 parts 1-7 • IEC/EN 62061 • IEC 61131-6 *
Network standards	EtherCAT, FSoE  Safety over 	IEC 617842-2-CPF12
	EtherNet/IP, CIP-Safety  	IEC 617842-2-CPF2
Programming languages		IEC 61131-3

* IEC 61131-6 is acquired by NX-SL5500/5700 only.

System configuration B (NX102+SL3)

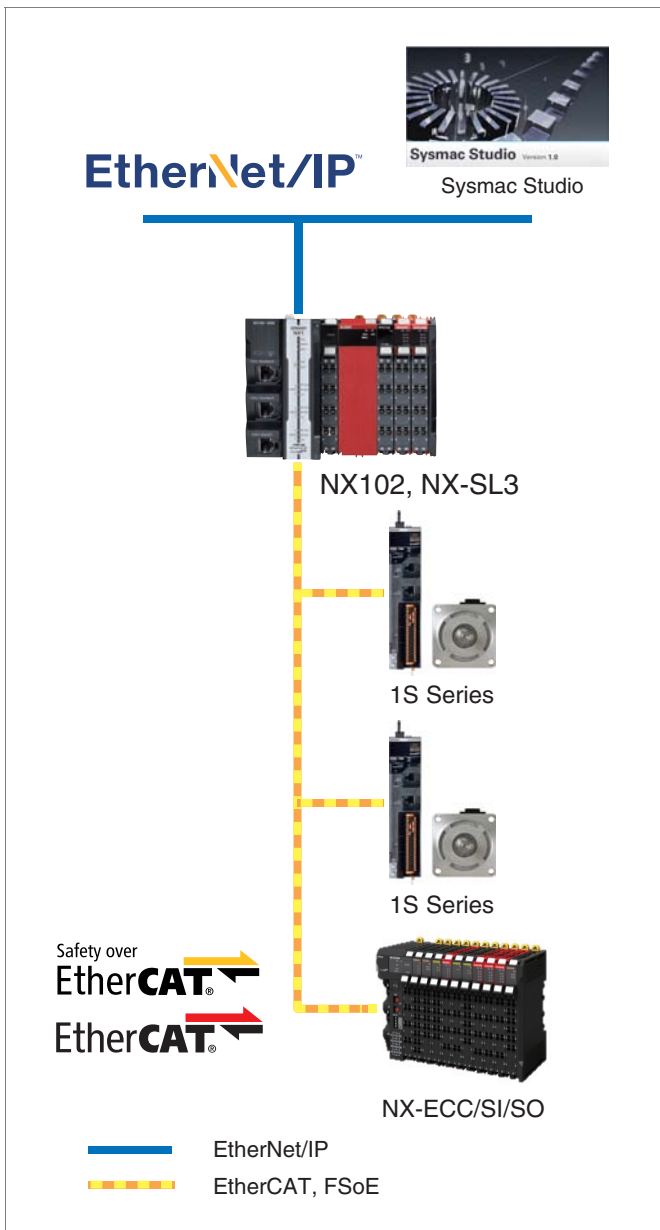

System configuration C (NJ+SL3)

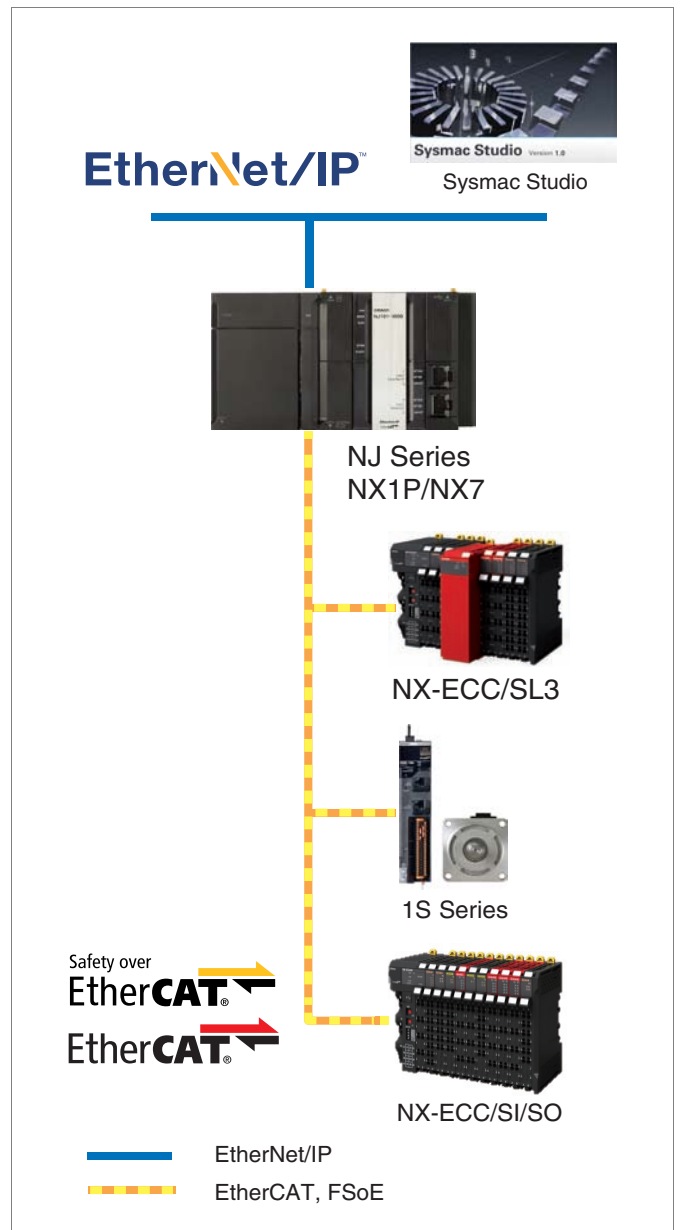

NX-SL5

NX-SL3

NX-SI/SO

Integrate safety into ultra-flexible, ultra-high-speed machine automation and build a distributed safety system



For the most recent information on models that have been certified for safety standards, refer to your OMRON website.

- Automatic generation, from safety programs through to safety functional test reports
- Data logging with fast cycle time to detect causes of downtime and degradation of safety components
- Integrated safety to EtherNet/IP™ for safety communication between machines
- Integrated safety over EtherCAT® for high-speed, high-precision fieldbus communication in a machine
- Easy to set up motion and robots that are the key to quality and productivity enhancement

- * The Common Industrial Protocol (CIP™) is an industry standard open network, enabling seamless communication among CIP networks. CIP Safety™ adds safety functionality to CIP networks.
- * Safety over EtherCAT (FSoE): The open protocol Safety over EtherCAT (abbreviated with FSoE "Safety over EtherCAT") defines a safety related communication layer for EtherCAT. Safety over EtherCAT meets the requirements of IEC 61508 SIL 3 and enables the transfer of safe and standard information on the same communication system without limitations with regard to transfer speed and cycle time.

Features

- Meets EN ISO 13849-1 (PLe/Safety Category 4) and IEC 61508 (SIL3)
- CIP Safety™ allows standard devices and safety devices to be mixed on the same EtherNet/IP network
- Safety over EtherCAT (FSoE) allows standard devices and safety devices to be mixed on the same EtherCAT® network
- Reusable safety program POUs according to IEC 61131-3 make programming more efficient
- PLCopen® Function Blocks for Safety reduce time and cost to learn safety design
- Safety I/O wiring diagrams, safety circuit programs, and user-defined Function Blocks can be automatically generated, minimizing safety design errors
- Simple Automatic Test using Offline Simulation is available. Online Functional Test ensures and maintains safety during machine commissioning and operation

Trademarks

- Sysmac and SYSMAC are trademarks or registered trademarks of OMRON Corporation in Japan and other countries for OMRON factory automation products.
- Microsoft, Windows, Windows Vista, Excel, and Visual Basic are either registered trademarks or trademarks of Microsoft Corporation in the United States and other countries.
- EtherCAT® is registered trademark and patented technology, licensed by Beckhoff Automation GmbH, Germany.
- Safety over EtherCAT® is a registered trademark and a patented technology licensed by Beckhoff Automation GmbH, Germany.
- ODVA, CIP™, CompoNet™, DeviceNet™, EtherNet/IP™, and CIP Safety™ are trademarks of ODVA.
- PLCopen® and related logo are registered trademarks of PLCopen®.
- The SD and SDHC logos are trademarks of SD-3C, LLC.

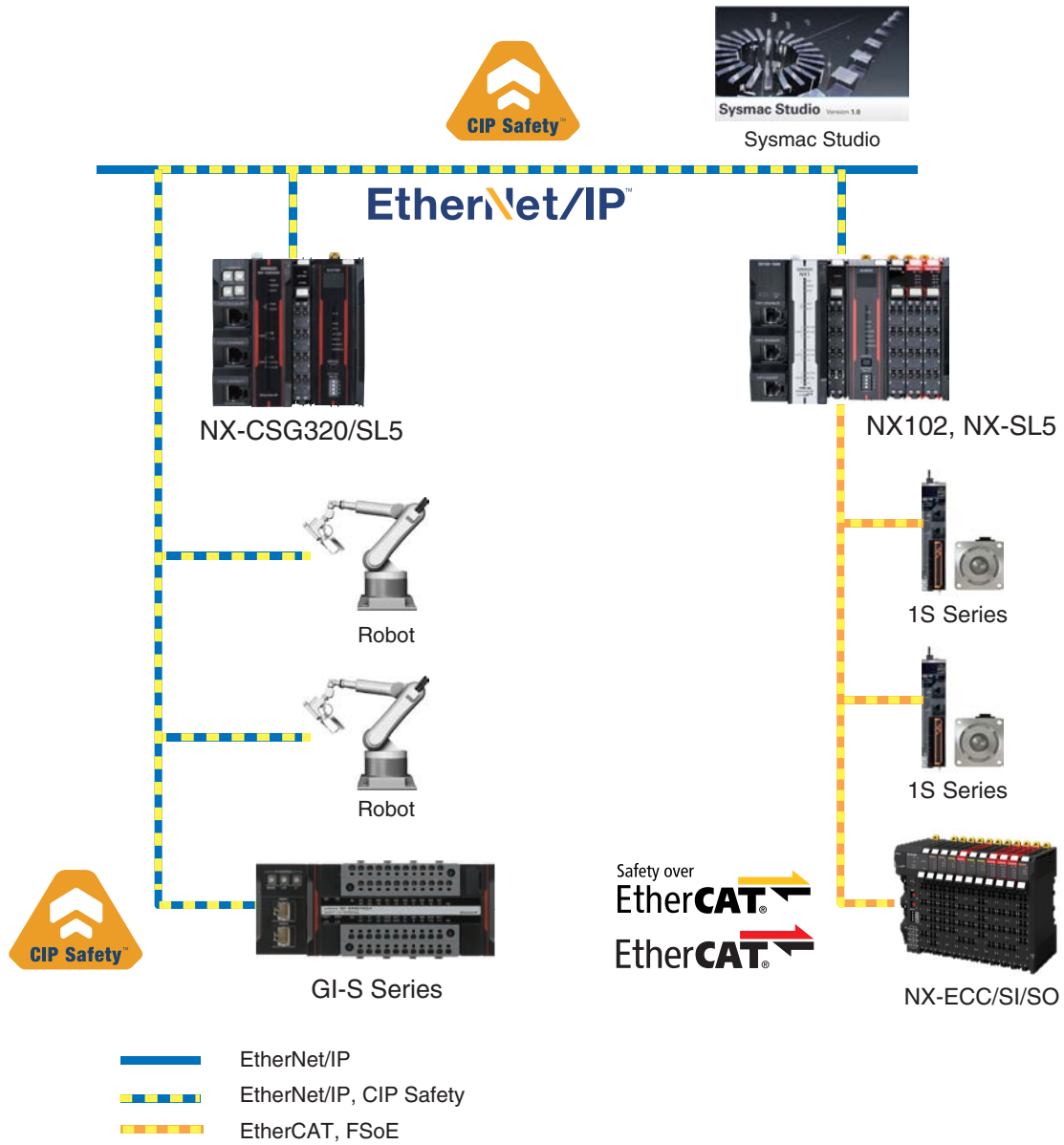

Other company names and product names in this document are the trademarks or registered trademarks of their respective companies.

System configuration



Ordering Information

Safety CPU Units NX-SL5500/5700

Unit type	Appearance	Specifications				Unit version	Model
		Maximum number of safety I/O points	Program capacity	Number of safety I/O connections	I/O refreshing method		
Safety CPU Unit (NX-SL5□□□)		1024 points	2048 KB	128	Free-Run refreshing	Ver. 1.4	NX-SL5500
		2032 points	4096 KB	254	Free-Run refreshing	Ver. 1.4	NX-SL5700

Accessories

There is no accessory.

Automation Software Sysmac Studio

Please purchase a DVD and required number of licenses the first time you purchase the Sysmac Studio. DVDs and licenses are available individually. Each model of licenses does not include any DVD.

Product name	Specifications	Number of licenses	Media	Model
Sysmac Studio Standard Edition Ver. 1.□□	The Sysmac Studio is the software that provides an integrated environment for setting, programming, debugging and maintenance of machine automation controllers including the NJ/NX-series CPU Units, NY-series Industrial PC, EtherCAT Slave, and the HMI.	--- (Media only)	Sysmac Studio 32-bit edition DVD	SYSMAC-SE200D
	Sysmac Studio runs on the following OS. Windows 7(32-bit/64-bit version)/8(32-bit/64-bit version)/8.1(32-bit/64-bit version)/10(32-bit/64-bit version) *1 For details, refer to your local OMRON website.	--- (Media only)	Sysmac Studio 64-bit edition DVD	SYSMAC-SE200D-64
	The Sysmac Studio Standard Edition DVD includes Support Software to set up EtherNet/IP Units, DeviceNet slaves, Serial Communications Units, and Support Software for creating screens on HMIs (CX-Designer). For details, refer to your local OMRON website.	1 license *2	---	SYSMAC-SE201L

Note: For details of the automation software Sysmac Studio, refer to your local OMRON website.

*1. SYSMAC-SE200D-64 runs on Windows 10 (64-bit edition).

*2. Multi licenses are available for the Sysmac Studio (3, 10, 30, or 50 licenses).

Regulations and Standards

NX-series Safety Control Units NX-SL5/SI/SO

Certification body	NX-SL5500/SL5700	NX-SI/SO
TÜV Rheinland *1	<ul style="list-style-type: none"> • EN ISO 13849-1 • EN ISO 13849-2 • IEC 61508 parts 1-7 • IEC/EN 62061 • IEC/EN 61131-2 • IEC 61326-3-1 	
	• IEC 61131-6 *2	---
UL	<ul style="list-style-type: none"> • NRAG (UL 61010-1 and UL 61010-2-201 and UL 121201) • NRAG7 (CSA C22.2 No. 61010-1 and CSA C22.2 No. 61010-2-201 and CSA C22.2 No. 213) 	<ul style="list-style-type: none"> • NRAG (UL 508 and ANSI/ISA 12.12.01) • NRAG7 (CSA C22.2 No. 142 and CSA C22.2 No. 213)
	• FSPC (IEC 61508 and ISO 13849) *2	---
Shipbuilding Standards	NK, LK	

*1. The FSoE protocol was certified for applications in which OMRON FSoE devices are connected to each other. For compatibility with FSoE devices other than OMRON FSoE devices, the customer must validate FSoE communications.

*2. Only NX-SL5500/5700 have obtained IEC 61131-6 and FSPC certifications.

The NX-series Safety Control Units allow you to build a safety control system that meets the following standards.

- Requirements for SIL 3 (Safety Integrity Level 3) in IEC 61508, IEC/EN 62061, (Functional Safety of Electrical/Electronic/Programmable Electronic Safety-related Systems)
- Requirements for PL_e (Performance Level e) and for safety category 4 in EN ISO13849-1

General Specifications

Item	Specification	
Enclosure	Mounted in a panel (open)	
Grounding method	Ground to 100 Ω or less	
Operating environment	Ambient operating temperature	0 to 55°C
	Ambient operating humidity	10% to 95% (with no condensation or icing)
	Atmosphere	Must be free from corrosive gases.
	Ambient storage temperature	-25 to 70°C (with no condensation or icing)
	Altitude	2,000 m max.
	Pollution degree	2 or less
	Noise immunity	Conforms to IEC 61131-2. 2 kV on power supply line
	Insulation class	Class III (SELV)
	Overvoltage category	II
	EMC immunity level	Zone B
	Vibration resistance	Conforms to IEC 60068-2-6. 5 to 8.4 Hz with 3.5-mm amplitude 8.4 to 150 Hz, acceleration of 9.8 m/s ² 100 minutes each in X, Y, and Z directions (10 sweeps of 10 min each = 100 min total)
	Shock resistance	Conforms to IEC 60068-2-27. 147 m/s ² , 3 times each in X, Y, and Z directions
	Insulation resistance *	20 MΩ between isolated circuits (at 100 VDC)
Dielectric strength *	510 VAC for 1 min between isolated circuits, leakage current: 5 mA max.	
Installation method	DIN Track (IEC 60715 TH35-7.5/TH35-15)	

* The specification is for the Communication Control Unit, Safety Input Unit, and Safety Output Unit, not for the Safety CPU Unit.

Unit Specifications

Unit name	Safety CPU Unit	
Model	NX-SL5500	NX-SL5700
Maximum number of safety I/O points	1024 points	2032 points
Program capacity	2048 KB	4096 KB
Number of safety master connections *1	128	254
Number of CIP Safety originator connections	128	254
Number of CIP Safety target connections	4	4
Number of originators that can be connected with a multi-cast connection	8	8
Number of FSoE master connections	128	254
I/O refreshing method	Free-Run refreshing	
External connection terminals	None	
Indicators		
Hardware switch settings		
Dimensions	30 × 100 × 71 mm (W × H × D)	
I/O power supply method	Not supplied.	
Current capacity of I/O power supply terminals	No I/O power supply terminals	
NX Unit power consumption *2	3.35 W max.	
Current consumption from I/O power supply	No consumption	
Weight	130 g max.	
Installation orientation and restrictions *3	Installation orientation: Upright installation Restriction: None.	

*1. This is the maximum number of Safety I/O connections that can be set to this Unit. The value is the total number of CIP Safety originator connections, CIP Safety target connections, and FSoE master connections.
 *2. The cable length for the Units (Communication Control Unit and Power Supply Unit for NX Units) that supply power to the corresponding Unit must be up to 20 m.
 *3. Only NX102 CPU Units and Communication Control Units can be connected. NX1P2 CPU Units or Communications Coupler Units cannot be connected.

Function Specifications

Refer to your local OMRON website for function specifications of the Safety Control Unit.

Version Information

Relationship between the Unit Versions of Safety Control Units and Sysmac Studio Versions

This section describes the combinations that can be used of the unit versions of the Safety Control Unit and NX102 CPU unit, and the version of the Sysmac Studio.

When connected with CPU rack

Safety Control Unit model and version		NX bus master: CPU Unit	
Model	Unit version	NX102 CPU unit	Sysmac Studio
NX-SL5500	Ver.1.3	Ver.1.31 or later	Ver.1.24 or later
	Ver.1.4		Ver.1.40 or later
NX-SL5700	Ver.1.2	---	---
	Ver.1.3	Ver.1.31 or later	Ver.1.24 or later
	Ver.1.4		Ver.1.40 or later
NX-SIH400	Ver.1.0	Ver.1.30 or later	Ver.1.22 or later
	Ver.1.1		
NX-SID800	Ver.1.0		
NX-SOH200			
NX-SOD400			

Part Names and Functions

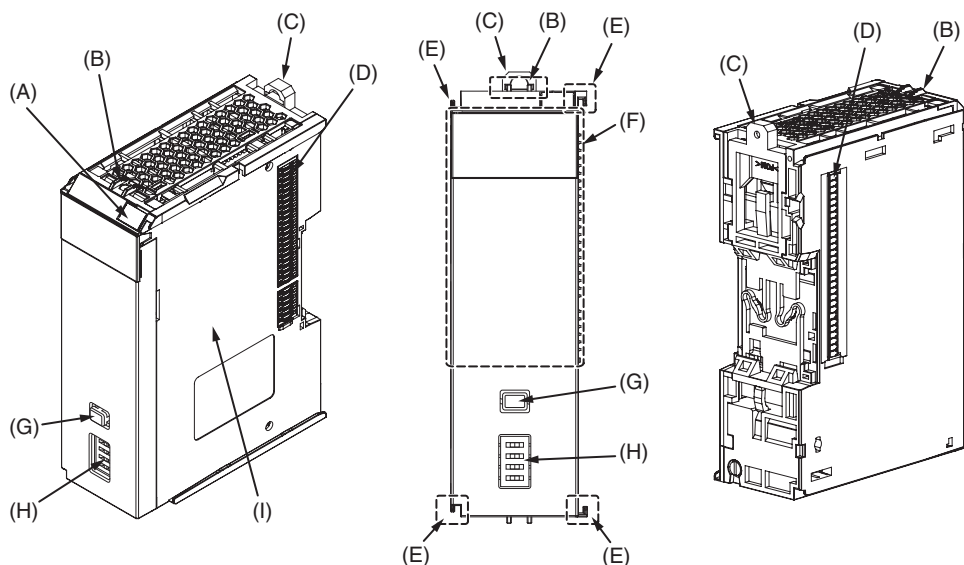

Letter	Name	Specification
(A)	Marker attachment locations	The locations where markers are attached. The markers made by OMRON are installed for the factory setting. Commercially available markers can also be installed.
(B)	Protrusions for removing the Unit	The protrusions to hold when removing the Unit.
(C)	DIN Track mounting hook	This hook is used to mount the NX Unit to a DIN Track.
(D)	NX bus connector	This is the NX-series bus connector.
(E)	Unit hookup guides	These guides are used to connect two Units.
(F)	Indicators	The indicators show the current operating status and power supply status of the Safety CPU Unit.
(G)	Service switch	This switch is used for the start trigger of various functions.
(H)	DIP switch	This switch is used for the Safety Unit Restore and the safety data logging function.
(I)	Unit specifications	The specifications of the Safety CPU Unit are given.

Indicators

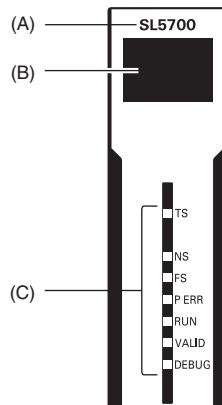

Letter	Name	Function
(A)	Model number display	Displays part of the model number of the Safety CPU Unit.
(B)	Seven-segment Indicator	Displays detailed information on the Safety CPU Unit.
(C)	Indicators	Show the current operating status and communications status of the Safety CPU Unit.

Indicator specifications

[TS] LED	The TS indicator shows the current status of the Safety CPU Unit and the communications status with the NX Bus Master.
[NS] LED	The NS indicator shows the CIP Safety communications status of the Safety CPU Unit.
[FS] LED	The FS indicator shows the FSoE communications status of the Safety CPU Unit.
[RUN] LED	The RUN indicator shows the execution status of the safety programs.
[DEBUG] LED	The DEBUG indicator shows the status whether the debug function can be executed on Safety CPU Unit.
[VALID] LED	The VALID indicator shows whether safety validation has been performed on the safety application data in the Safety CPU Unit.

Seven-segment Indicator

The two-digit seven-segment indicator shows the detailed information on the Safety CPU Unit.

At normal operation, When an error occurs, When a signature code is checked, When the Safety Unit Restore is executed, When the Safety Data Logging is executed

NX Unit Configuration

CPU Rack

The CPU Rack consists of an NX-series NX102 CPU Unit, NX Units, and an End Cover.
Up to 32 NX Units can be connected.

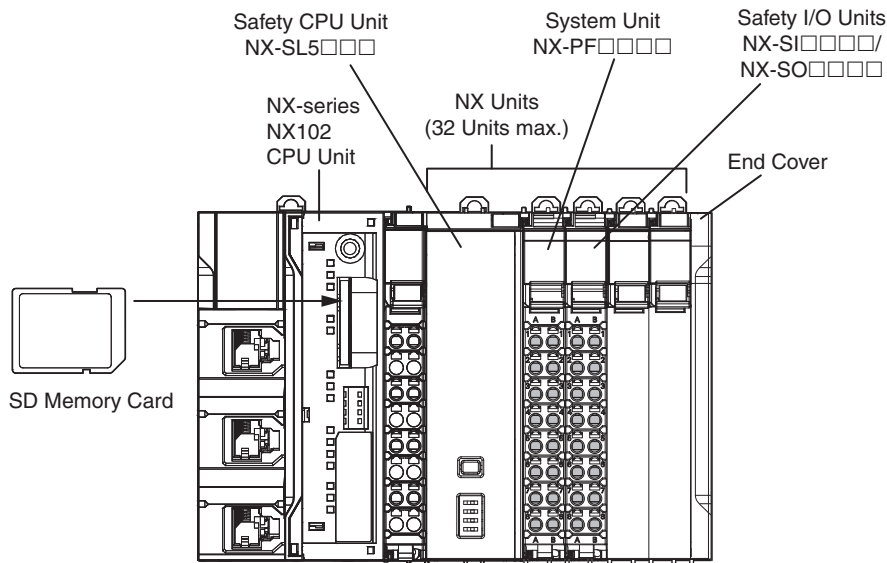

Up to 32 Units can be mounted to each CPU Rack.
For restrictions of the NX unit, refer to *NX-series NX102 CPU Unit Hardware User's Manual (W593)*.

Series	Configuration	Remarks
NX-series	NX-series NX102 CPU Unit	One required for every CPU Rack. Up to 32 Units can be mounted to each CPU Rack. For restrictions of the NX unit, refer to <i>NX-series NX102 CPU Unit Hardware User's Manual (W593)</i> .
	End Cover	Must be connected to the right end of the CPU Rack. One End Cover is provided with the CPU Unit.
	Safety Control Units	This is a programmable safety controller which supports IEC 61131-3 and PLCopen® TC5 Safety. This unit consists of safety CPU unit and safety I/O unit.
	Safety CPU Unit NX-SL5□□□	This Unit has safety control functions. It operates as an NX Unit. It also operates as an FSoE master. It operates as a CIP-Safety-on-EtherNet/IP device.
	Safety I/O Units	These Units have safety input functions or safety output functions. They operate as NX Units. These Units operate as FSoE slaves.
	Safety Input Unit	These Units have safety input functions.
	Safety Output Unit	These Units have safety output functions.
	System Unit	When the I/O power supply for the NX Unit connected to the CPU Unit is supplied through the NX bus, the IO power supply unit (NX-PF) must be used as well.
	Other NX units	For the latest lineup of NX units, refer to our catalog and our website, or inquire of our local representative.
NJ/NX-series	SD Memory Card	Install as required.

NX-SL5

NX-SL3

NX-SI/SO

Safety CPU Units NX-SL5500/SL5700

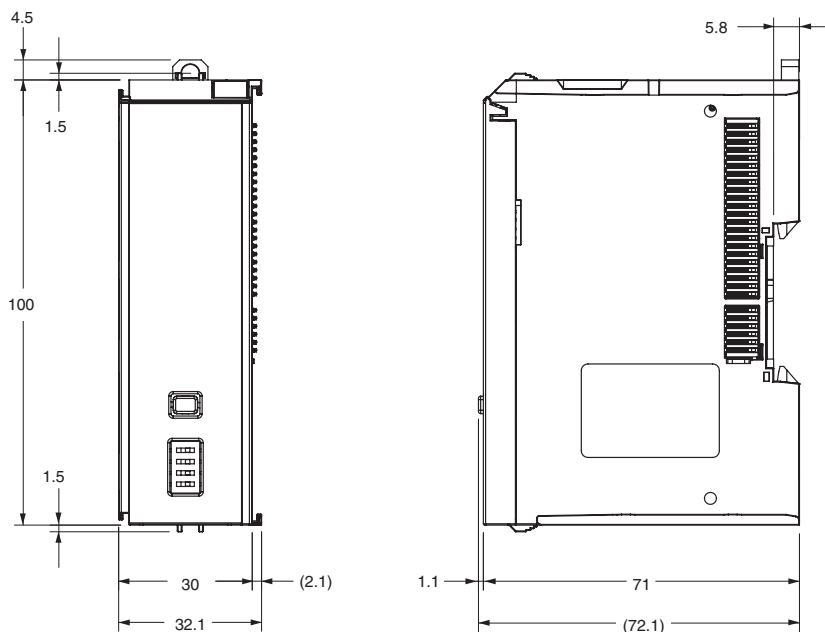

Related Manuals

Related Manuals	Cat. No.	Model numbers	Application	Description
NX-series Safety Control Unit User's Manual	Z930	NX-SL□□□□ NX-SI□□□□□ NX-SO□□□□□	Learning how to use the NX-series Safety Control Units.	Describes the hardware, setup methods, and functions of the NX-series Safety Control Units.
NX-series Safety Control Unit Instructions Reference Manual	Z931	NX-SL□□□□□	Learning about the specifications of instructions for the Safety CPU Unit.	Describes the instructions for the Safety CPU Unit.
NX-series NX102 CPU Unit Hardware User's Manual	W593	NX102-□□□□□	Learning the basic specifications of the NX102 CPU Units, including introductory information, designing, installation, and maintenance. Mainly hardware information is provided.	An introduction to the entire NX102 system is provided along with the following information on the CPU Unit. <ul style="list-style-type: none"> • Features and system configuration • Introduction • Part names and functions • General specifications • Installation and wiring • Maintenance and Inspection
NX-series Data Reference Manual	W525	NX-□□□□□	Referencing lists of the data that is required to configure systems with NX-series Units.	Lists of the power consumptions, weights, and other NX Unit data that is required to configure systems with NX-series Units are provided.
Sysmac Studio Version 1 Operation Manual	W504	SYSMAC-SE2□□□□	Learning about the operating procedures and functions of the Sysmac Studio.	Describes the operating procedures of the Sysmac Studio.
NX-series System Units User's Manual	W523	NX-PD1□□□□ NX-PF0□□□□ NX-PC0□□□□ NX-TB□□□□X	Learning how to use NX-series System Units.	The hardware and functions of the NX-series System Units are described.

The simplest way to integrate safety into ultra-high-speed machine automation - Bring safety to your production site



For the most recent information on models that have been certified for safety standards, refer to your OMRON website.

- Integrated safety over EtherCAT® for high-speed, high-precision fieldbus communication in a machine
- Easy to set up motion that is the key to quality and productivity enhancement

* Safety over EtherCAT (FSoE): The open protocol Safety over EtherCAT (abbreviated with FSoE "FailSafe over EtherCAT") defines a safety related communication layer for EtherCAT®. Safety over EtherCAT meets the requirements of IEC 61508 SIL 3 and enables the transfer of safe and standard information on the same communication system without limitations with regard to transfer speed and cycle time.

Features

- Meets EN ISO 13849-1 (PLe/Safety Category 4) and IEC 61508 (SIL3)
- Safety over EtherCAT (FSoE) allows standard devices and safety devices to be mixed on the same EtherCAT® network
- Reusable safety program POU's according to IEC 61131-3 make programming more efficient
- PLCopen® Function Blocks for Safety reduce time and cost to learn safety design
- Safety I/O wiring diagrams, safety circuit programs, and user-defined Function Blocks can be automatically generated, minimizing safety design errors
- Simple Automatic Test using Offline Simulation is available. Online Functional Test ensures and maintains safety during machine commissioning and operation

- Sysmac is a trademark or registered trademark of OMRON Corporation in Japan and other countries for OMRON factory automation products.
- EtherCAT® is registered trademark and patented technology, licensed by Beckhoff Automation GmbH, Germany.
- Safety over EtherCAT® is registered trademark and patented technology, licensed by Beckhoff Automation GmbH, Germany.
- ODVA, CIP™, CompoNet™, DeviceNet™, EtherNet/IP™, and CIP Safety™ are trademarks of ODVA.
- PLCopen® and related logo are registered trademarks of PLCopen®.

Other company names and product names in this document are the trademarks or registered trademarks of their respective companies.

System configuration

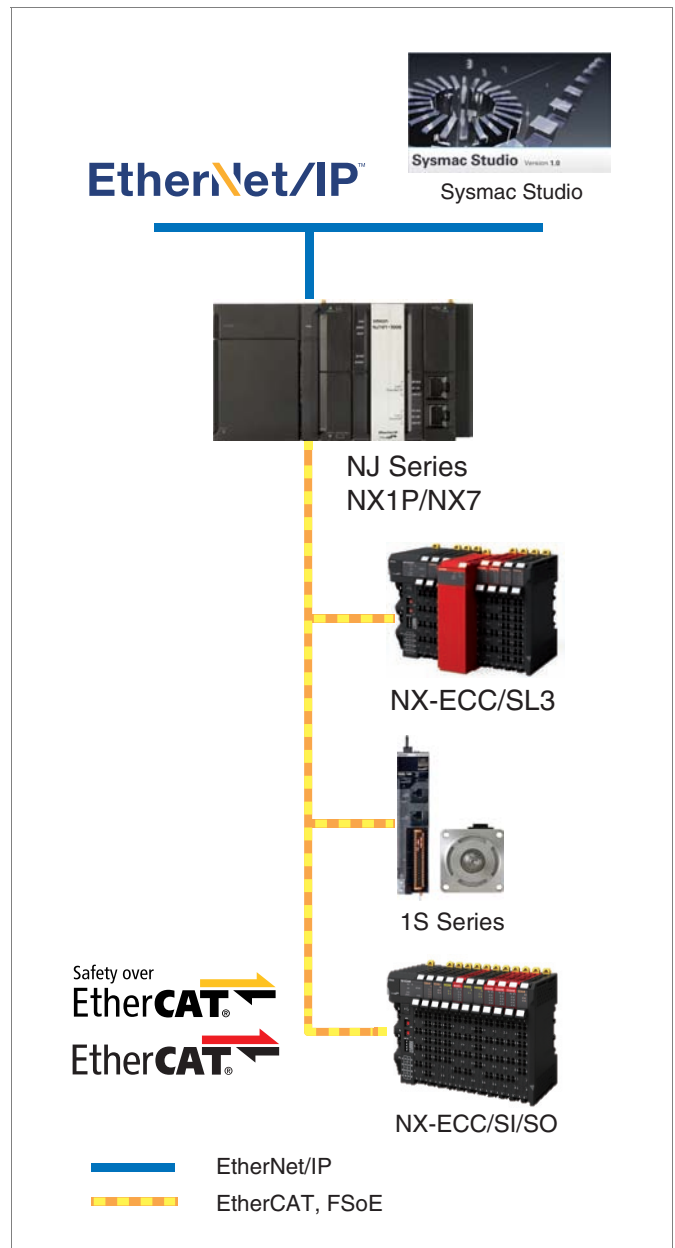
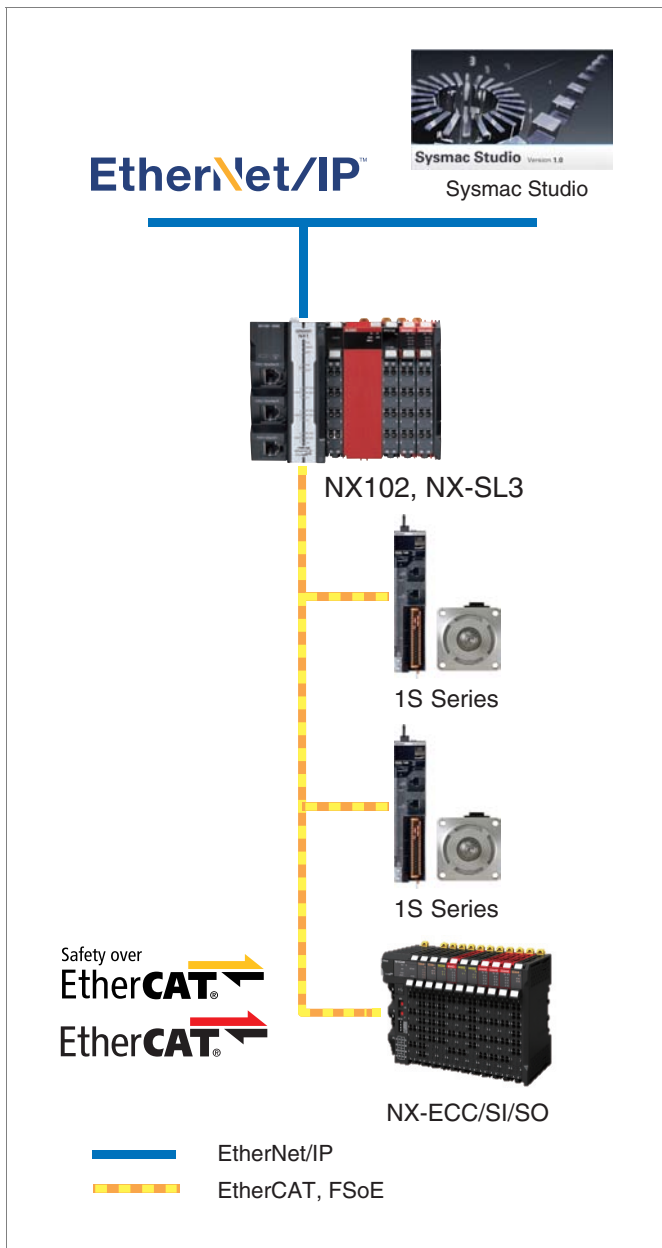

System configuration (NX102+SL3)

System configuration (NJ+SL3)



Ordering Information

Safety CPU Unit NX-SL3300/3500

Unit type	Appearance	Specifications				Unit version	Model
		Maximum number of safety I/O points	Program capacity	Number of safety I/O connections	I/O refreshing method		
Safety CPU Unit (NX-SL3□□0)		256 points	512KB	32	Free-Run refreshing	Ver. 1.1	NX-SL3300
		1024 points	2048KB	128	Free-Run refreshing	Ver. 1.1	NX-SL3500

Accessories

Not included.

Automation Software Sysmac Studio

Please purchase a DVD and required number of licenses the first time you purchase the Sysmac Studio. DVDs and licenses are available individually. Each model of licenses does not include any DVD.

Product name	Specifications	Number of licenses	Media	Model
Sysmac Studio Standard Edition Ver.1.□□ *3		---	Sysmac Studio 64-bit edition DVD	SYSMAC-SE200D-64
		1 license	---	SYSMAC-SE201L

Note: For details of the automation software Sysmac Studio, refer to your local OMRON website.

*1 Only EtherNet/IP coupler can be used for NX-I/O edition.

*2 Safety Edition can be used with Communication Control Unit and EtherNet/IP Coupler Unit.

*3 The Sysmac Studio Standard Edition with license(s) (SYSMAC-SE□□□L) provides functions of the NX-I/O Edition (SYSMAC-NE001L).

With the Sysmac Studio Standard Edition with license(s) (SYSMAC-SE□□□L) version 1.10 or higher, you can use the setup functions for the EtherNet/IP Coupler.

*4 SYSMAC-SE200D-64 runs on Windows 10 (64-bit edition).

Regulations and Standards

NX-series Safety Control Units NX-SL3/SI/SO

Certification body	Standards
TÜV Rheinland *	<ul style="list-style-type: none"> • EN ISO 13849-1 • EN ISO 13849-2 • IEC 61508 parts 1-7 • IEC/EN 62061 • IEC/EN 61131-2 • IEC 61326-3-1
UL	<ul style="list-style-type: none"> • NRAG (UL 508 and ANSI/ISA 12.12.01) • NRAG7 (CSA C22.2 No. 142 and CSA C22.2 No. 213)
Shipbuilding Standards	NK, LK

* The FSoE was certified for applications in which OMRON FSoE devices are connected to each other.

The NX-series Safety Control Units allow you to build a safety control system that meets the following standards.

- Requirements for SIL 3 (Safety Integrity Level 3) in IEC 61508, EN 62061, (Functional Safety of Electrical/Electronic/Programmable Electronic Safety-related Systems)
- Requirements for PLe (Performance Level e) and for safety category 4 in EN ISO13849-1



The NX-series Safety Control Units are also registered for RCM, EAC, and KC compliance.

General Specifications

Item	Specification	
Enclosure	Mounted in a panel (open)	
Grounding method	Ground to 100 Ω or less.	
Operating environment	Ambient operating temperature	0 to 55°C (The upper limit of the ambient operating temperature is restricted by the installation orientation.)
	Ambient operating humidity	10% to 95% (with no condensation or icing)
	Atmosphere	Must be free from corrosive gases.
	Ambient storage temperature	-25 to 70°C (with no condensation or icing)
	Altitude	2,000 m max.
	Pollution degree	2 or less.
	Noise immunity	Conforms to IEC 61131-2. 2 kV on power supply line (Conforms to IEC 61000-4-4.)
	Insulation class	Class III (SELV)
	Overvoltage category	II
	EMC immunity level	Zone B
	Vibration resistance	Conforms to IEC 60068-2-6. 5 to 8.4 Hz with 3.5-mm amplitude, 8.4 to 150 Hz, acceleration of 9.8 m/s ² , 100 minutes each in X, Y, and Z directions (10 sweeps of 10 min each = 100 min total)
	Shock resistance	Conforms to IEC 60068-2-27. 147 m/s ² , 3 times each in X, Y, and Z directions
	Insulation resistance *	20 MΩ between isolated circuits (at 100 VDC)
Dielectric strength *	510 VAC for 1 min between isolated circuits, leakage current: 5 mA max.	
Installation method	DIN Track (IEC 60715 TH35-7.5/TH35-15)	

* The specification is for the Communication Control Unit, Safety Input Unit, and Safety Output Unit, not for the Safety CPU Unit.

Unit Specifications

Unit name		Safety CPU Unit	
Model	NX-SL3300	NX-SL3500	
Maximum number of safety I/O points	256 points	1024 points	
Program capacity	512 KB	2048 KB	
Number of safety I/O connections	32	128	
Number of FSoE master connections	32	128	
I/O refreshing method	Free-Run refreshing		
External connection terminals	None		
Indicators			
Dimensions	30 × 100 × 71 mm (W × H × D)		
I/O power supply method	Not supplied.		
Current capacity of I/O power supply terminals	No I/O power supply terminals		
NX Unit power consumption *1	<ul style="list-style-type: none"> Connected to a CPU Unit 1.25 W max. Connected to a Communications Coupler Unit 0.90 W max. 		
Current consumption from I/O power supply	No consumption		
Weight	75 g max.		
Installation orientation and restrictions *2	Installation orientation: <ul style="list-style-type: none"> Connected to a CPU Unit Possible in the upright installation orientation. Connected to a Communications Coupler Unit Six possible orientations. Restriction: None		

*1 The cable length for the Units that supply power to the corresponding Unit must be up to 20 m.

*2 Only NX102 CPU Units can be connected. NX1P2 CPU Units cannot be connected.

Version Information

This section describes the possible combinations of versions of Safety Control Units, NJ/NX-series CPU Units, and Communications Coupler Units.

Safety Control Unit model and version		NX bus master: NX102 CPU Unit	NX bus master: EtherCAT Coupler Unit		Sysmac Studio
Model	Unit version	NX102 CPU unit	Communications Coupler Unit	NJ/NX1P/NX7 CPU Unit	
NX-SL3300	Ver.1.0	Ver.1.30 or later	Ver.1.1 or later	Ver.1.06 or later	Ver.1.22 or later
	Ver.1.1				
NX-SL3500	Ver.1.0	Ver.1.30 or later	Ver.1.2 or later	Ver.1.07 or later	Ver.1.22 or later
	Ver.1.1				
NX-SIH400	Ver.1.0	Ver.1.30 or later	Ver.1.2 or later	Ver.1.06 or later	Ver.1.22 or later
	Ver.1.1				
NX-SID800	Ver.1.0	Ver.1.30 or later	Ver.1.1 or later	Ver.1.06 or later	Ver.1.22 or later
NX-SOD400	Ver.1.0	Ver.1.30 or later	Ver.1.1 or later	Ver.1.06 or later	Ver.1.22 or later
NX-SOD200	Ver.1.0	Ver.1.30 or later	Ver.1.1 or later	Ver.1.06 or later	Ver.1.22 or later

Part Names and Functions

Safety CPU Unit NX-SL3300/SL3500

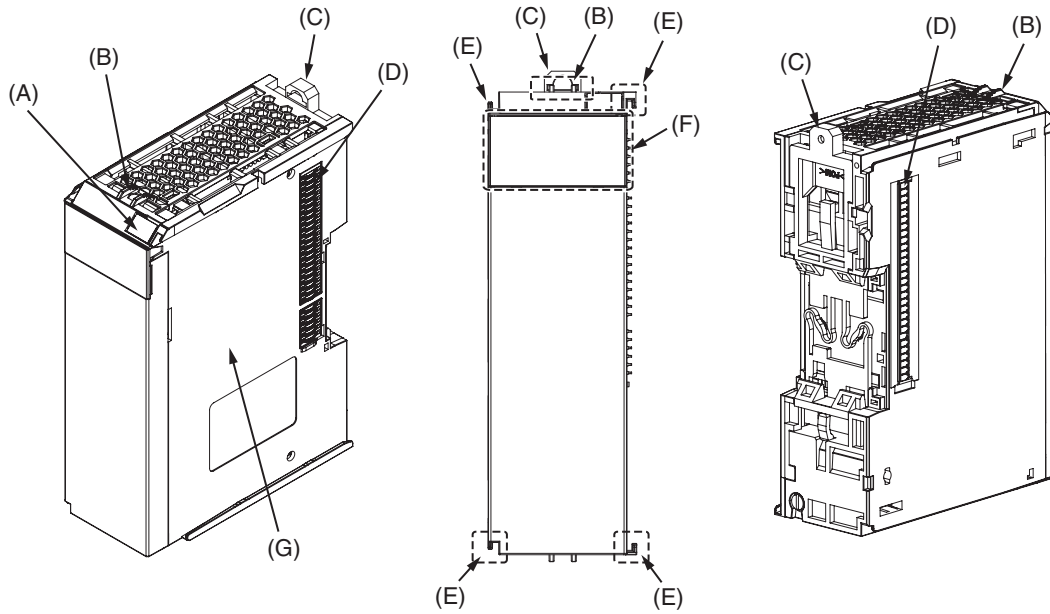

Letter	Item	Specification
(A)	Marker attachment locations	The locations where markers are attached. The markers made by OMRON are installed for the factory setting. Commercially available markers can also be installed.
(B)	Protrusions for removing the Unit	The protrusions to hold when removing the Unit.
(C)	DIN Track mounting hooks	These hooks are used to mount the NX Unit to a DIN Track.
(D)	NX bus connector	This is the NX-series bus connector. It is used to connect an NX-series Safety I/O Unit or other NX Unit.
(E)	Unit hookup guides	These guides are used to connect two Units.
(F)	Indicators	The indicators show the current operating status of the NX Unit or signal I/O status.
(G)	Unit specifications	The specifications of the NX Unit are given here.

Indicators

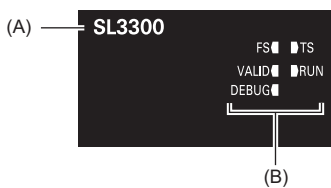

Letter	Name	Function
(A)	Model number display	Displays part of the model number of the Safety CPU Unit.
(B)	Indicators	The indicators show the current operating status and communications status of the Safety CPU Unit.

Indicator specifications

[TS] LED	The TS indicator shows the current operating status and communications status of the Safety CPU Unit.
[FS] LED	The FS indicator shows the safety communications status and safety function status of the Safety CPU Unit.
[RUN] LED	The RUN indicator shows the execution status of the safety programs.
[DEBUG] LED	The DEBUG indicator shows the status whether the debug function is executable on Safety CPU Unit.
[VALID] LED	The VALID indicator shows whether safety validation has been performed.

NX Unit Configuration

CPU Rack

The CPU Rack consists of an NX-series NX102 CPU Unit, NX Units, and an End Cover.
Up to 32 NX Units can be connected.

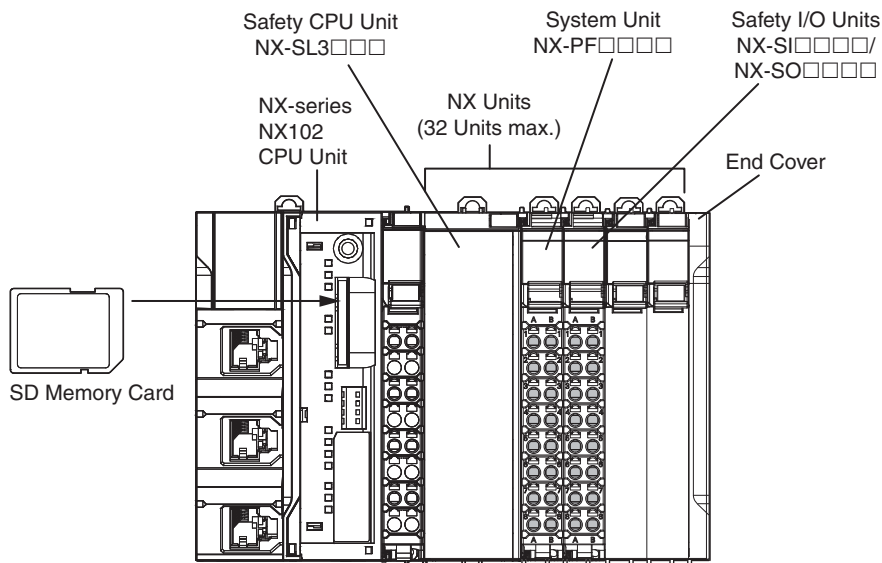

Up to 32 Units can be mounted to each CPU Rack.
For restrictions of the NX unit, refer to *NX-series NX102 CPU Unit Hardware User's Manual (W593)*.

Series	Configuration	Remarks
NX-series	NX-series NX102 CPU Unit	One required for every CPU Rack. Up to 32 Units can be mounted to each CPU Rack. For restrictions of the NX unit, refer to <i>NX-series NX102 CPU Unit Hardware User's Manual (W593)</i> .
	End Cover	Must be connected to the right end of the CPU Rack. One End Cover is provided with the CPU Unit.
	Safety Control Units	This is a programmable safety controller which supports IEC 61131-3 and PLCopen® TC5 Safety. This unit consists of safety CPU unit and safety I/O unit.
	Safety CPU Unit NX-SL3□□□	This Unit has safety control functions. It operates as an NX Unit. It also operates as an FSoE master. It operates as a CIP-Safety-on-EtherNet/IP device.
	Safety I/O Units	These Units have safety input functions or safety output functions. They operate as NX Units. These Units operate as FSoE slaves.
	Safety Input Unit	These Units have safety input functions.
	Safety Output Unit	These Units have safety output functions.
	System Unit	When the I/O power supply for the NX Unit connected to the CPU Unit is supplied through the NX bus, the IO power supply unit (NX-PF) must be used as well.
	Other NX units	For the latest lineup of NX units, refer to our catalog and our website, or inquire of our local representative.
NJ/NX-series	SD Memory Card	Install as required.

EtherCAT slave terminal

The EtherCAT slave terminal consists of NX-ECC EtherCAT coupler unit, component units of the NX unit, and end cover. Up to 63 NX Units can be connected.

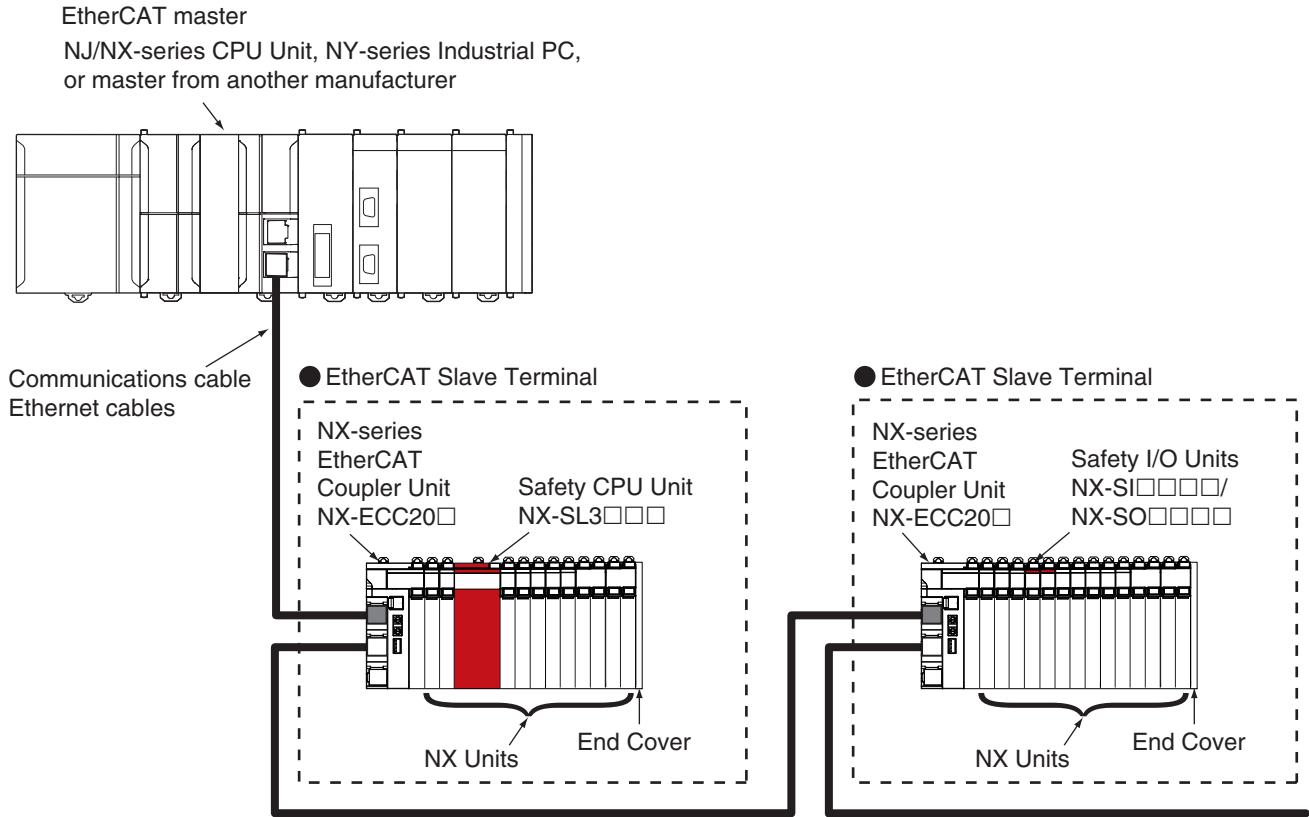

For restrictions of the NX unit, refer to *NX-series EtherCAT® Coupler Unit User's Manual (W519)*.

Series	Configuration	Remarks			
NJ/NX-series	EtherCAT master	The EtherCAT master manages the EtherCAT network, monitors the status of the slaves, and exchanges I/O data with the slaves.			
NX-series	NX-series EtherCAT Coupler Unit NX-ECC□□□	The EtherCAT Coupler Unit is an interface that performs process data communications between a group of NX Units and the EtherCAT master over an EtherCAT network. The I/O data for the NX Units is first accumulated in the EtherCAT Coupler Unit and then all of the data is exchanged with the EtherCAT master at the same time. The EtherCAT Coupler Unit can also perform message communications (SDO communications) with the EtherCAT master. You can connect up to 63 NX Units.			
	End Cover	This is required on the right end of the EtherCAT slave terminal. One cover comes with each coupler unit by default.			
	NX Units	The NX Units perform I/O processing with connected external devices. The NX Units perform process data communications with the EtherCAT master through the EtherCAT Coupler Unit.			
	System Unit	System Units are used as required to build a Slave Terminal.			
	Safety Control Units	The Safety Control Units constitute a programmable safety controller that complies with IEC 61131-3 and PLCopen® TC5 Safety. They include Safety CPU Units and Safety I/O Units.			
	<table border="1" style="width: 100%;"> <tr> <td>Safety CPU Unit NX-SL3□□□</td> <td>This Unit controls the Safety I/O Units through the NX bus and EtherCAT.</td> </tr> <tr> <td>Safety I/O Units</td> <td>Safety CPU unit control this units through the NX bus and EtherCAT.</td> </tr> </table>	Safety CPU Unit NX-SL3□□□	This Unit controls the Safety I/O Units through the NX bus and EtherCAT.	Safety I/O Units	Safety CPU unit control this units through the NX bus and EtherCAT.
Safety CPU Unit NX-SL3□□□	This Unit controls the Safety I/O Units through the NX bus and EtherCAT.				
Safety I/O Units	Safety CPU unit control this units through the NX bus and EtherCAT.				
Other NX units	For types of NX units, refer to <i>NX-series EtherCAT® Coupler Unit User's Manual (W519)</i> . For details of units, refer to the User's Manual of each unit. For the latest lineup of NX units, refer to our catalog and our website, or inquire of our local representative.				

Dimensions

Safety CPU Unit NX-SL3300/SL3500

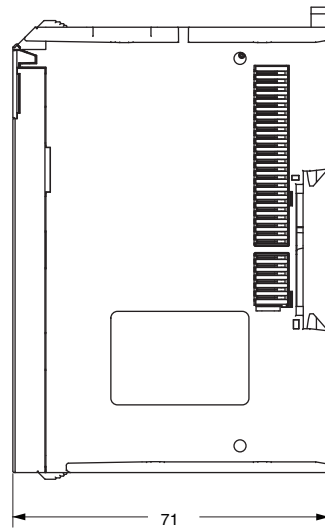
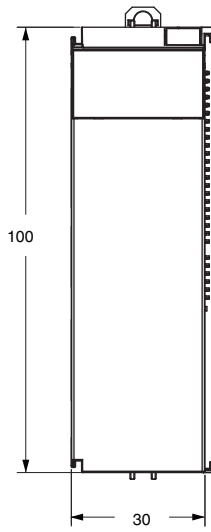

NX-SL5

NX-SL3

NX-SI/SO

Related Manuals

Cat. No.	Model number	Manual name	Application	Description
Z930	NX-SL□□□□ NX-SI□□□□ NX-SO□□□□	NX-series Safety Control Unit User's Manual	Learning how to use NX-series Safety Control Units.	Describes the hardware, setup methods, and functions of the NX-series Safety Control Units.
Z931	NX-SL□□□□	NX-series Safety Control Unit Instructions Reference Manual	Learning about the specifications of instructions for the Safety CPU Unit.	Describes the instructions for the Safety CPU Unit. When programming, use this manual together with the <i>NX-series Safety Control Units User's Manual</i> (Cat. No. Z930).
W504	SYSMAC-SE2□□□	Sysmac Studio Version 1 Operation Manual	Learning about the operating procedures and functions of the Sysmac Studio.	Describes the operating procedures of the Sysmac Studio.
W593	NX102-□□□□	NX-series NX102 CPU Unit Hardware User's Manual	Learning the basic specifications of the NX102 CPU Units, including introductory information, designing, installation, and maintenance. Mainly hardware information is provided.	An introduction to the entire NX102 system is provided along with the following information on the CPU Unit. <ul style="list-style-type: none"> • Features and system configuration • Introduction • Part names and functions • General specifications • Installation and wiring • Maintenance and Inspection
W519	NX-ECC□□□	NX-series EtherCAT® Coupler Unit User's Manual	Learning how to use the NX-series EtherCAT Coupler Unit and EtherCAT Slave Terminals.	The following items are described: the overall system and configuration methods of an EtherCAT Slave Terminal (which consists of an NX-series EtherCAT Coupler Unit and NX Units), and information on hardware, setup, and functions to set up, control, and monitor NX Units through EtherCAT.

Build a simple and flexible safety system

- Free combination of four types of safety input and output units
- Flexible panel design with a width of 12 mm per unit
- Quick wiring with detachable screwless clamping terminal block
- Direct connection to dedicated safety input components



For the most recent information on models that have been certified for safety standards, refer to your OMRON website.

* Safety over EtherCAT (FSoE): The open protocol Safety over EtherCAT (abbreviated with FSoE "FailSafe over EtherCAT") defines a safety related communication layer for EtherCAT. Safety over EtherCAT meets the requirements of IEC 61508 SIL 3 and enables the transfer of safe and standard information on the same communication system without limitations with regard to transfer speed and cycle time.

Features



- Meets EN ISO 13849-1 (PLe/Safety Category 4) and IEC 61508 (SIL3)
- Safety over EtherCAT (FSoE) allows standard devices and safety devices to be mixed on the same EtherCAT® network
- CIP Safety™ allows standard devices and safety devices to be mixed on the same EtherNet/IP™ network
- Omron's safety input components that require dedicated controllers can be connected directly

- Sysmac is a trademark or registered trademark of OMRON Corporation in Japan and other countries for OMRON factory automation products.
 - EtherCAT® is registered trademark and patented technology, licensed by Beckhoff Automation GmbH, Germany.
 - Safety over EtherCAT® is registered trademark and patented technology, licensed by Beckhoff Automation GmbH, Germany.
 - ODVA, CIP™, CompoNet™, DeviceNet™, EtherNet/IP™, and CIP Safety™ are trademarks of ODVA.
- Other company names and product names in this document are the trademarks or registered trademarks of their respective companies.

Ordering Information

Safety I/O Unit

Safety Input Units

Unit type	Appearance	Specifications							Unit version	Model
		Number of safety input points	Number of test output points	Internal I/O common	Rated input voltage	OMRON special safety input devices	Number of safety slave connections	I/O refreshing method		
Safety Input Units		4 points	2 points	Sinking inputs (PNP)	24 VDC	Can be connected. *	1	Free-Run refreshing	Ver. 1.1	NX-SIH400
		8 points	2 points	Sinking inputs (PNP)	24 VDC	Cannot be connected.	1	Free-Run refreshing	Ver. 1.0	NX-SID800

* The following OMRON special safety input devices can be connected directly without a special controller.



For detail of connectable OMRON special safety input devices, refer to NX-series Safety Control Units User's Manual (Cat.No.Z930).

Type	Model and corresponding PL and safety category
OMRON Single-beam Safety Sensors	E3ZS, E3FS *
OMRON Non-contact Door Switches	D40Z D40A
OMRON Safety Mats	UM *, UMA
OMRON Safety Edges	SGE (4-wire connection)

* E3FS series is no longer available for order after August 2016.

E3FS series is no longer available for order after June 2019.

Safety Output Units

Unit type	Appearance	Specifications						Unit version	Model
		Number of safety output points	Internal I/O common	Maximum load current	Rated voltage	Number of safety slave connections	I/O refreshing method		
Safety Output Units		2 points	Sourcing outputs (PNP)	2.0 A/point, 4.0 A/Unit at 40°C, and 2.5 A/Unit at 55°C The maximum load current depends on the installation orientation and ambient temperature.	24 VDC	1	Free-Run refreshing	Ver. 1.0	NX-SOH200
		4 points	Sourcing outputs (PNP)	0.5 A/point and 2.0 A/Unit	24 VDC	1	Free-Run refreshing	Ver. 1.0	NX-SOD400

Option

Product Name	Specification	Model
Unit/Terminal Block Coding Pins	For 10 Units (Terminal Block: 30 pins, Unit: 30 pins)	NX-AUX02

Product name	Specification				Model
	No. of terminals	Terminal number indications	Ground terminal mark	Terminal current capacity	
Terminal Block	8	A/B	None	10A	NX-TBA082
	16	A/B	None	10A	NX-TBA162

Accessories

Not included.

Regulations and Standards

NX-series Safety I/O Units NX-SI/SO

Certification body	Standards
TÜV Rheinland *	<ul style="list-style-type: none"> • EN ISO 13849-1 • EN ISO 13849-2 • IEC 61508 parts 1-7 • IEC/EN 62061 • IEC/EN 61131-2 • IEC 61326-3-1
UL	<ul style="list-style-type: none"> • NRAG (UL 508 and ANSI/ISA 12.12.01) • NRAG7 (CSA C22.2 No. 142 and CSA C22.2 No. 213)
Shipbuilding Standards	NK, LK

* The FSoE was certified for applications in which OMRON FSoE devices are connected to each other.

The NX-series Safety Control Units allow you to build a safety control system that meets the following standards.

- Requirements for SIL 3 (Safety Integrity Level 3) in IEC 61508, EN 62061, (Functional Safety of Electrical/Electronic/Programmable Electronic Safety-related Systems)
- Requirements for PL e (Performance Level e) and for safety category 4 in EN ISO13849-1

The NX-series Safety Control Units are also registered for RCM, EAC, and KC compliance.

General Specifications

Item	Specification	
Enclosure	Mounted in a panel (open)	
Grounding method	Ground to 100 Ω or less.	
Operating environment	Ambient operating temperature	0 to 55°C (The upper limit of the ambient operating temperature is restricted by the installation orientation.)
	Ambient operating humidity	10% to 95% (with no condensation or icing)
	Atmosphere	Must be free from corrosive gases.
	Ambient storage temperature	-25 to 70°C (with no condensation or icing)
	Altitude	2,000 m max.
	Pollution degree	2 or less.
	Noise immunity	Conforms to IEC 61131-2. 2 kV on power supply line (Conforms to IEC 61000-4-4.)
	Insulation class	Class III (SELV)
	Overvoltage category	II
	EMC immunity level	Zone B
	Vibration resistance	Conforms to IEC 60068-2-6. 5 to 8.4 Hz with 3.5-mm amplitude, 8.4 to 150 Hz, acceleration of 9.8 m/s ² , 100 minutes each in X, Y, and Z directions (10 sweeps of 10 min each = 100 min total)
	Shock resistance	Conforms to IEC 60068-2-27. 147 m/s ² , 3 times each in X, Y, and Z directions
	Insulation resistance	20 MΩ between isolated circuits (at 100 VDC)
Dielectric strength	510 VAC for 1 min between isolated circuits, leakage current: 5 mA max.	
Installation method	DIN Track (IEC 60715 TH35-7.5/TH35-15)	

NX-SI/SO

Unit Specifications

Safety Input Units NX-SIH400/SID800

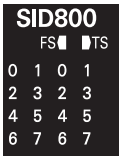
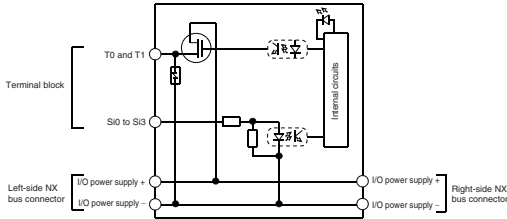
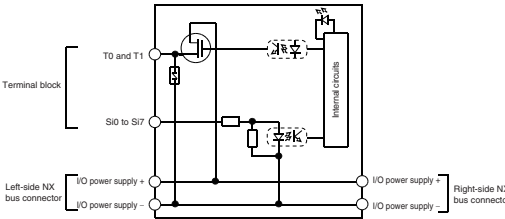
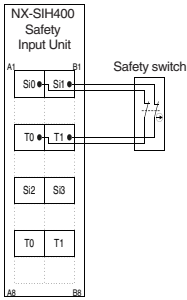
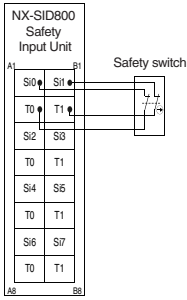
Unit name	Safety Input Unit	
Model	NX-SIH400	NX-SID800
Number of safety input points	4 points	8 points
Number of test output points	2 points	2 points
Internal I/O common	PNP (sinking inputs)	
Rated input voltage	24 VDC (20.4 to 28.8 VDC)	
OMRON special safety input devices	Can be connected.	Cannot be connected.
Number of safety slave connections	1	
I/O refreshing method	Free-Run refreshing	
External connection terminals	Screwless clamping terminal block (8 terminals)	Screwless clamping terminal block (16 terminals)
Indicators		
Safety input current	4.5 mA typical	3.0 mA typical
Safety input ON voltage	11 VDC min.	15 VDC min.
Safety input OFF voltage/OFF current	5 VDC max., 1 mA max.	
Test output type	Sourcing outputs (PNP)	
Test output load current	25 mA max.	50 mA max.
Test output residual voltage	1.2 V max. (Between IOV and all output terminals)	
Test output leakage current	0.1 mA max.	
Dimensions	12 × 100 × 71 mm (W × H × D)	
Isolation method	Photocoupler isolation	
Insulation resistance	20 MΩ min. between isolated circuits (at 100 VDC)	
Dielectric strength	510 VAC for 1 min between isolated circuits, leakage current: 5 mA max.	
I/O power supply method	Power supplied from the NX bus	
Current capacity of I/O power supply terminals	No applicable terminals.	
NX Unit power consumption	<ul style="list-style-type: none"> Connected to a CPU Unit or a Communication Control Unit 1.10 W max. Connected to a Communications Coupler Unit 0.70 W max. 	<ul style="list-style-type: none"> Connected to a CPU Unit or a Communication Control Unit 1.10 W max. Connected to a Communications Coupler Unit 0.75 W max.
Current consumption from I/O power supply	20 mA max.	
Weight	70 g max.	
Circuit layout		
Terminal connection diagram	<p>Si0 to Si3: Safety input terminals T0 and T1: Test output terminals</p>  <p>Refer to User's manual (Cat.No.Z930) for details.</p>	<p>Si0 to Si7: Safety input terminals T0 and T1: Test output terminals</p>  <p>Refer to User's manual (Cat.No.Z930) for details.</p>

Unit name	Safety Input Unit
Installation orientation and restrictions	Installation orientation: <ul style="list-style-type: none"> • Connected to a CPU Unit or a Communication Control Unit * • Possible in the upright installation orientation. • Connected to a Communications Coupler Unit 6 possible orientations. Restrictions: Maximum ambient temperature is 50°C for any orientation other than upright installation.
Protective functions	Overvoltage protection circuit and short detection (test outputs)

* It can be connected to the NX102 CPU unit or communication control unit. It cannot be connected to the NX1P2 CPU unit.

NX-SL5

NX-SL3

NX-SI/SO

Safety Output Units NX-SOH200/SOD400

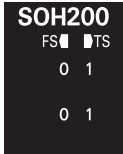
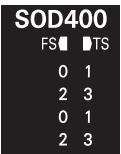
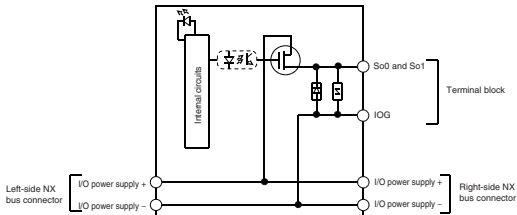
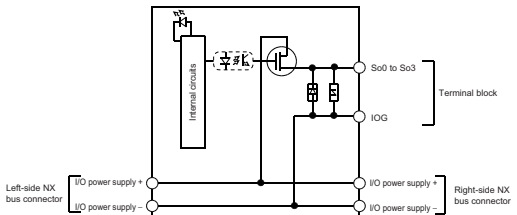
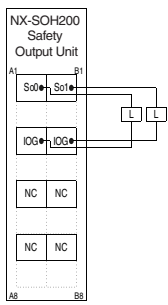
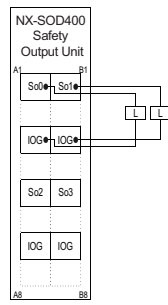
Unit name	Safety Output Unit	
Model	NX- SOH200	NX-SOD400
Number of safety output points	2 points	4 points
Internal I/O common	PNP (sourcing outputs)	
Maximum load current	2.0 A/point 4.0 A/Unit at 40°C 2.5 A/Unit at 55°C The maximum load current depends on the installation orientation and ambient temperature	0.5 A/point and 2.0 A/Unit
Rated voltage	24 VDC (20.4 to 28.8 VDC)	
Number of safety slave connections	1	
I/O refreshing method	Free-Run refreshing	
External connection terminals	Screwless clamping terminal block (8 terminals)	
Indicators		
Safety output ON residual voltage	1.2 V max. (Between IOV and all output terminals)	
Safety output OFF residual voltage	2 V max. (Between IOG and all output terminals)	
Safety output leakage current	0.1 mA max.	
Dimensions	12 × 100 × 71 mm (W × H × D)	
Isolation method	Photocoupler isolation	
Insulation resistance	20 MΩ min. between isolated circuits (at 100 VDC)	
Dielectric strength	510 VAC for 1 min between isolated circuits, leakage current: 5 mA max.	
I/O power supply method	Power supplied from the NX bus	
Current capacity of I/O power supply terminals	IOG: 2 A max./terminal	IOG (A3 and B3): 2 A max./terminal IOG (A7 and B7): 0.5 A max./terminal
NX Unit power consumption	<ul style="list-style-type: none"> Connected to a CPU Unit or a Communication Control Unit 1.05 W max. Connected to a Communications Coupler Unit 0.70 W max. 	<ul style="list-style-type: none"> Connected to a CPU Unit or a Communication Control Unit 1.10 W max. Connected to a Communications Coupler Unit 0.75 W max.
Current consumption from I/O power supply	40 mA max.	60 mA max.
Weight	65 g max.	
Circuit layout		
Terminal connection diagram	<p>So0 and So1: Safety output terminals IOG: I/O power supply 0 V</p>  <p>Refer to User's manual (Cat.No.Z930) for details.</p>	<p>So0 to So3: Safety output terminals IOG: I/O power supply 0 V</p>  <p>Refer to User's manual (Cat.No.Z930) for details.</p>

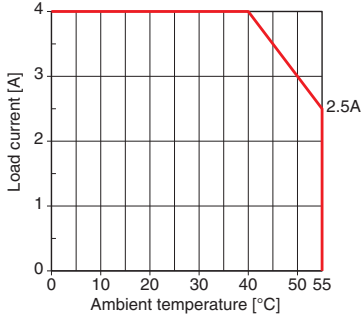
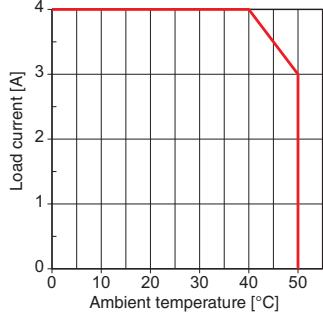
Unit name	Safety Output Unit	
Model	NX- SOH200	NX-SOD400
<p>Installation orientation and restrictions</p>	<p>Installation orientation:</p> <ul style="list-style-type: none"> • Connected to a CPU Unit or a Communication Control Unit * Possible in the upright installation orientation. • Connected to a Communications Coupler Unit 6 possible orientations <p>Restrictions: For upright installation, the ambient temperature is restricted as shown below depending on the total Unit load current.</p>  <p>For all installation orientations other than upright installation, the ambient temperature is restricted as shown below according to the total Unit load current.</p> 	<p>Installation orientation:</p> <ul style="list-style-type: none"> • Connected to a CPU Unit or a Communication Control Unit * Possible in the upright installation orientation. • Connected to a Communications Coupler Unit 6 possible orientations <p>Restrictions: None</p>
	<p>Protective functions Overvoltage protection circuit and short detection</p>	

* It can be connected to the NX102 CPU unit or communication control unit. It cannot be connected to the NX1P2 CPU unit.

Function Specifications

Refer to the *SYSMAC-SE* Datasheet (www.ia.omron.com/) for function specifications of the Safety Control Unit.

NX-SI/SO

Version Information

This section describes the possible combinations of versions of Safety I/O Units, NJ/NX-series CPU Units, and Communications Coupler Units.

Safety Control Unit model and version		NX bus master: NX102 CPU Unit	NX bus master: EtherCAT Coupler Unit		Sysmac Studio
Model	Unit version	NX102 CPU unit	Communications Coupler Unit	NJ/NX1P/NX7 CPU Unit	
NX-SIH400	Ver.1.0	Ver.1.30 or later	Ver.1.2 or later	Ver.1.06 or later	Ver.1.22 or higher
	Ver.1.1				
NX-SID800	Ver.1.0	Ver.1.30 or later	Ver.1.1 or later	Ver.1.06 or later	Ver.1.22 or higher
NX-SOD400	Ver.1.0	Ver.1.30 or later	Ver.1.1 or later	Ver.1.06 or later	Ver.1.22 or higher
NX-SOD200	Ver.1.0	Ver.1.30 or later	Ver.1.1 or later	Ver.1.06 or later	Ver.1.22 or higher

Part Names and Functions

Safety Input Unit NX-SIH400/SID800
 Safety Output Unit NX-SOH200/SOD400

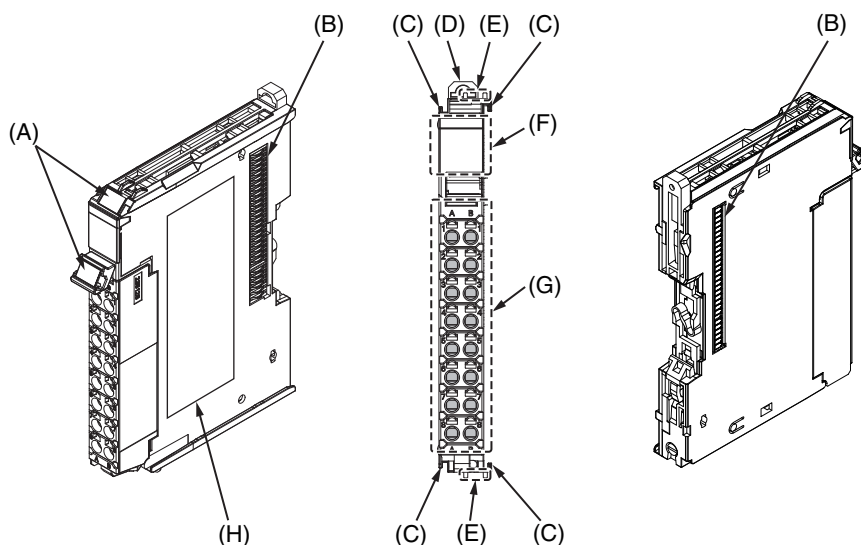

Letter	Item	Specification
(A)	Marker attachment locations	The locations where markers are attached. The markers made by OMRON are installed for the factory setting. Commercially available markers can also be installed.
(B)	NX bus connector	This is the NX-series bus connector. Connect this connector to another Unit, such as the NX-series Safety CPU Unit or a Safety I/O Unit.
(C)	Unit hookup guides	These guides are used to connect two Units.
(D)	DIN Track mounting hooks	These hooks are used to mount the NX Unit to a DIN Track.
(E)	Protrusions for removing the Unit	The protrusions to hold when removing the Unit.
(F)	Indicators	The indicators show the current operating status of the NX Unit or signal I/O status.
(G)	Terminal block	The terminal block is used to connect to external devices. It connects the safety outputs. The number of terminals depends on the NX Unit.
(H)	Unit specifications	The specifications of the NX Unit are given here.

Indicators

The indicator pattern depends on the number of input points, as shown below.

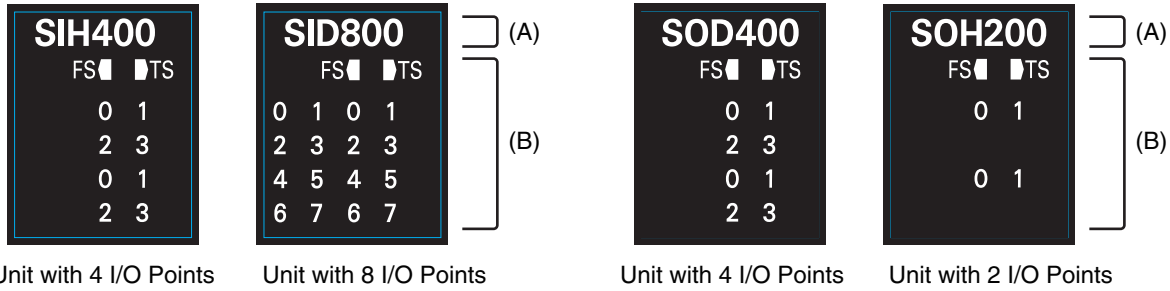

Letter	Name	Function
(A)	Model number display	Displays part of the model number of the Safety I/O Units. The model number indication is red on all Safety Control Units.
(B)	Indicators	Show the current operating status and communications status of the Safety I/O Units.

NX-SIH400/SID800

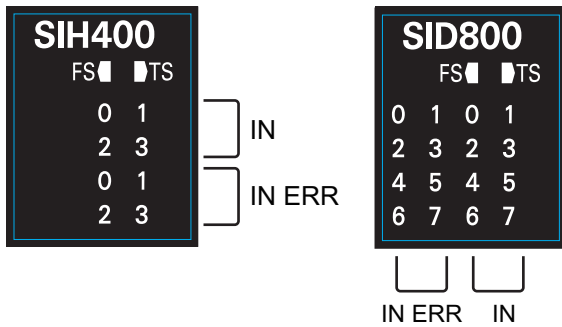

Indicator specifications

[TS] LED	The TS indicator shows the current status of the Safety Input Unit and its communications status with the NX Bus Master.
[FS] LED	The FS indicator shows the FSoE communications status and safety function status of the Safety Input Unit.
[IN] LED	The IN indicator shows the signal input status of the safety input terminal.
[IN ERR] LED	The IN ERR indicator shows the error status of the safety input terminal.

NX-SOD400/SOH200

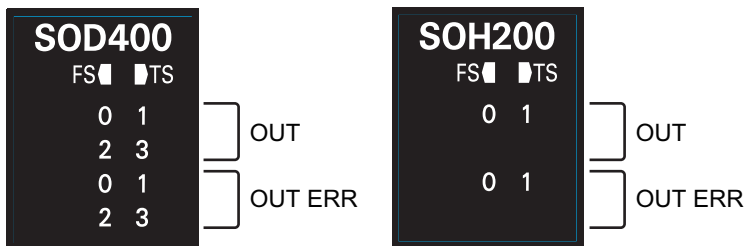

Indicator specifications

[TS] LED	The TS indicator shows the current status of the Safety Output Unit and its communications status with the NX Bus Master.
[FS] LED	The FS indicator shows the FSoE communications status and safety function status of the Safety Output Unit.
[OUT] LED	The OUT indicator shows the signal input status of the safety output terminal.
[OUT ERR] LED	The OUT ERR indicator shows the error status of the safety output terminals.

Terminal Blocks

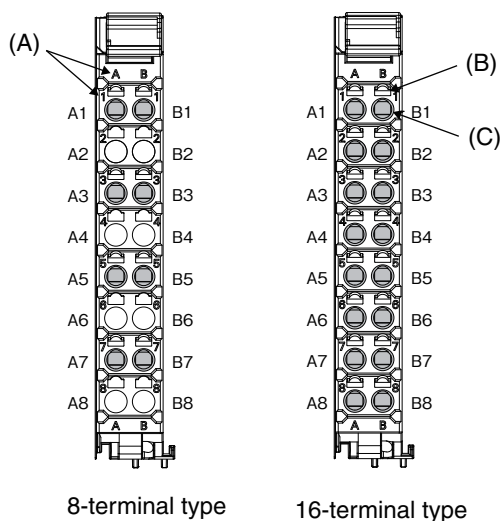

8-terminal type

16-terminal type

Letter	Item	Specification
(A)	Terminal number indications	The terminal numbers are given by column letters A and B, and row numbers 1 to 8. The combination of the column and row gives the terminal numbers from A1 to A8 and B1 to B8. The terminal number indicators are the same regardless of the number of terminals on the terminal block, as shown above.
(B)	Release holes	Insert a flat-blade screwdriver into these holes to connect and remove the wires.
(C)	Terminal holes	The wires are inserted into these holes.

Applicable Terminal Blocks for Each Unit Model

Unit model number	Terminal Blocks				
	Model	No. of terminals	Terminal number indications	Ground terminal mark	Terminal current capacity
NX-SIH400	NX-TBA082	8	A/B	None	10A
NX-SID800	NX-TBA162	16	A/B	None	10A
NX-SOH200	NX-TBA082	8	A/B	None	10A
NX-SOD400	NX-TBA082	8	A/B	None	10A

Applicable Wires

Using Ferrules

If you use ferrules, attach the twisted wires to them.

Observe the application instructions for your ferrules for the wire stripping length when attaching ferrules.

Always use plated one-pin ferrules. Do not use unplated ferrules or two-pin ferrules.

The applicable ferrules, wires, and crimping tool are given in the following table.

Terminal types	Manufacturer	Ferrule model number	Applicable wire (mm ² (AWG))	Crimping tool	
Terminals other than ground terminals	Phoenix Contact	AI0,34-8	0.34 (#22)	Phoenix Contact (The figure in parentheses is the applicable wire size.) CRIMPFOX 6 (0.25 to 6 mm ² , AWG24 to 10)	
		AI0,5-8	0.5 (#20)		
		AI0,5-10	0.75 (#18)		
		AI0,75-8			
		AI0,75-10	1.0 (#18)		
		AI1,0-8			
		AI1,0-10			
		AI1,5-8	1.5 (#16)		
AI1,5-10	2.0 *				
AI2,5-10					
Ground terminals					
Terminals other than ground terminals	Weidmuller	H0.14/12	0.14 (#26)		Weidmuller (The figure in parentheses is the applicable wire size.) PZ6 Roto (0.14 to 6 mm ² , AWG 26 to 10)
		H0.25/12	0.25 (#24)		
		H0.34/12	0.34 (#22)		
		H0.5/14	0.5 (#20)		
		H0.5/16			
		H0.75/14	0.75 (#18)		
		H0.75/16			
		H1.0/14	1.0 (#18)		
		H1.0/16			
		H1.5/14	1.5 (#16)		
H1.5/16					

* Some AWG 14 wires exceed 2.0 mm² and cannot be used in the screwless clamping terminal block.

When you use any ferrules other than those in the above table, crimp them to the twisted wires so that the following processed dimensions are achieved.

Finished Dimensions of Ferrules

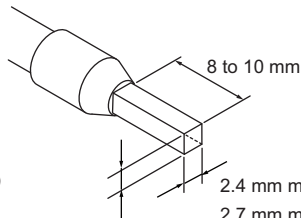

1.6 mm max. (except ground terminals)

2.0 mm max. (ground terminals)

2.4 mm max. (except ground terminals)

2.7 mm max. (ground terminals)

Using Twisted Wires/Solid Wires

If you use the twisted wires or the solid wires, use the following table to determine the correct wire specifications.

Terminals		Wire type				Wire size	Conductor length (stripping length)
		Twisted wires		Solid wire			
Classification	Current capacity	Plated	Unplated	Plated	Unplated		
All terminals except ground terminals	2 A max.	Possible	Possible	Possible	Possible	0.08 to 1.5 mm ² AWG28 to 16	8 to 10 mm
	Greater than 2 A and 4 A or less		Not Possible	Possible *1	Not Possible		
	Greater than 4 A		Possible *1	Not Possible	Not Possible		
Ground terminals	---	Possible	Possible	Possible *2	Possible *2	2.0 mm ²	9 to 10 mm

*1 Secure wires to the screwless clamping terminal block. Refer to the *Securing Wires* in the USER'S MANUAL for how to secure wires.

*2 With the NX-TB□□□1 Terminal Block, use twisted wires to connect the ground terminal. Do not use a solid wire.

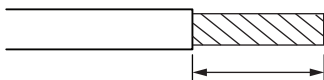

Conductor length (stripping length)

<Additional Information> If more than 2 A will flow on the wires, use plated wires or use ferrules.

Dimensions

Safety Input Units NX-SIH400/SID800
 Safety Output Units NX-SOH200/SOD400

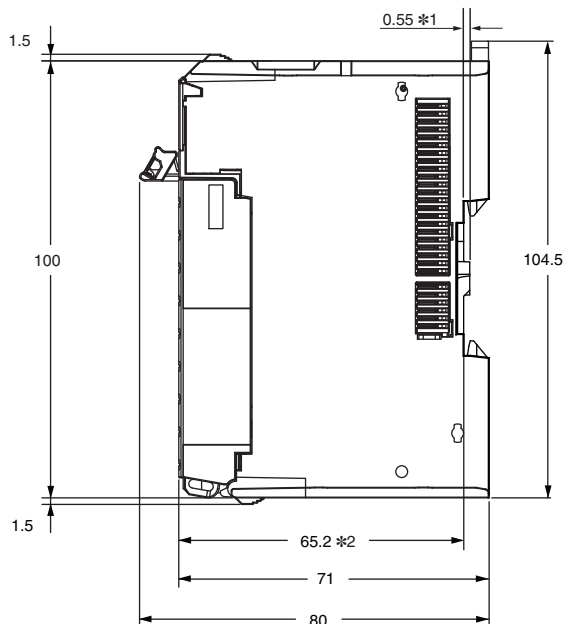
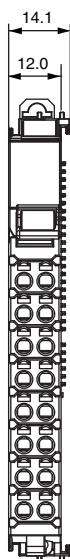

*1 The dimension is 1.35 mm for Units with lot numbers through December 2014.

*2 The dimension from the attachment surface of the DIN Track to the front surface of the Safety I/O Unit.

NX-SLS5

NX-SLS3

NX-SI/SO

Related Manuals

Cat. No.	Model number	Manual name	Application	Description
Z930	NX-SL□□□□ NX-SI□□□□ NX-SO□□□□	NX-series Safety Control Unit User's Manual	Learning how to use NX-series Safety Control Units.	Describes the hardware, setup methods, and functions of the NX-series Safety Control Units.
Z931	NX-SL□□□□	NX-series Safety Control Unit Instructions Reference Manual	Learning about the specifications of instructions for the Safety CPU Unit.	Describes the instructions for the Safety CPU Unit. When programming, use this manual together with the <i>NX-series Safety Control Units User's Manual</i> (Cat. No. Z930).
W504	SYSMAC-SE2□□□	Sysmac Studio Version 1 Operation Manual	Learning about the operating procedures and functions of the Sysmac Studio.	Describes the operating procedures of the Sysmac Studio.
W593	NX102-□□□□	NX-series NX102 CPU Unit Hardware User's Manual	Learning the basic specifications of the NX102 CPU Units, including introductory information, designing, installation, and maintenance. Mainly hardware information is provided.	An introduction to the entire NX102 system is provided along with the following information on the CPU Unit. <ul style="list-style-type: none"> • Features and system configuration • Introduction • Part names and functions • General specifications • Installation and wiring • Maintenance and Inspection
W519	NX-ECC□□□	NX-series EtherCAT® Coupler Unit User's Manual	Learning how to use the NX-series EtherCAT Coupler Unit and EtherCAT Slave Terminals.	The following items are described: the overall system and configuration methods of an EtherCAT Slave Terminal (which consists of an NX-series EtherCAT Coupler Unit and NX Units), and information on hardware, setup, and functions to set up, control, and monitor NX Units through EtherCAT.

Terms and Conditions Agreement

Read and understand this catalog.

Please read and understand this catalog before purchasing the products. Please consult your OMRON representative if you have any questions or comments.

Warranties.

(a) Exclusive Warranty. Omron's exclusive warranty is that the Products will be free from defects in materials and workmanship for a period of twelve months from the date of sale by Omron (or such other period expressed in writing by Omron). Omron disclaims all other warranties, express or implied.

(b) Limitations. OMRON MAKES NO WARRANTY OR REPRESENTATION, EXPRESS OR IMPLIED, ABOUT NON-INFRINGEMENT, MERCHANTABILITY OR FITNESS FOR A PARTICULAR PURPOSE OF THE PRODUCTS. BUYER ACKNOWLEDGES THAT IT ALONE HAS DETERMINED THAT THE PRODUCTS WILL SUITABLY MEET THE REQUIREMENTS OF THEIR INTENDED USE.

Omron further disclaims all warranties and responsibility of any type for claims or expenses based on infringement by the Products or otherwise of any intellectual property right. (c) Buyer Remedy. Omron's sole obligation hereunder shall be, at Omron's election, to (i) replace (in the form originally shipped with Buyer responsible for labor charges for removal or replacement thereof) the non-complying Product, (ii) repair the non-complying Product, or (iii) repay or credit Buyer an amount equal to the purchase price of the non-complying Product; provided that in no event shall Omron be responsible for warranty, repair, indemnity or any other claims or expenses regarding the Products unless Omron's analysis confirms that the Products were properly handled, stored, installed and maintained and not subject to contamination, abuse, misuse or inappropriate modification. Return of any Products by Buyer must be approved in writing by Omron before shipment. Omron Companies shall not be liable for the suitability or unsuitability or the results from the use of Products in combination with any electrical or electronic components, circuits, system assemblies or any other materials or substances or environments. Any advice, recommendations or information given orally or in writing, are not to be construed as an amendment or addition to the above warranty.

See <http://www.omron.com/global/> or contact your Omron representative for published information.

Limitation on Liability; Etc.

OMRON COMPANIES SHALL NOT BE LIABLE FOR SPECIAL, INDIRECT, INCIDENTAL, OR CONSEQUENTIAL DAMAGES, LOSS OF PROFITS OR PRODUCTION OR COMMERCIAL LOSS IN ANY WAY CONNECTED WITH THE PRODUCTS, WHETHER SUCH CLAIM IS BASED IN CONTRACT, WARRANTY, NEGLIGENCE OR STRICT LIABILITY.

Further, in no event shall liability of Omron Companies exceed the individual price of the Product on which liability is asserted.

Suitability of Use.

Omron Companies shall not be responsible for conformity with any standards, codes or regulations which apply to the combination of the Product in the Buyer's application or use of the Product. At Buyer's request, Omron will provide applicable third party certification documents identifying ratings and limitations of use which apply to the Product. This information by itself is not sufficient for a complete determination of the suitability of the Product in combination with the end product, machine, system, or other application or use. Buyer shall be solely responsible for determining appropriateness of the particular Product with respect to Buyer's application, product or system. Buyer shall take application responsibility in all cases.

NEVER USE THE PRODUCT FOR AN APPLICATION INVOLVING SERIOUS RISK TO LIFE OR PROPERTY OR IN LARGE QUANTITIES WITHOUT ENSURING THAT THE SYSTEM AS A WHOLE HAS BEEN DESIGNED TO ADDRESS THE RISKS, AND THAT THE OMRON PRODUCT(S) IS PROPERLY RATED AND INSTALLED FOR THE INTENDED USE WITHIN THE OVERALL EQUIPMENT OR SYSTEM.

Programmable Products.

Omron Companies shall not be responsible for the user's programming of a programmable Product, or any consequence thereof.

Performance Data.

Data presented in Omron Company websites, catalogs and other materials is provided as a guide for the user in determining suitability and does not constitute a warranty. It may represent the result of Omron's test conditions, and the user must correlate it to actual application requirements. Actual performance is subject to the Omron's Warranty and Limitations of Liability.

Change in Specifications.

Product specifications and accessories may be changed at any time based on improvements and other reasons. It is our practice to change part numbers when published ratings or features are changed, or when significant construction changes are made. However, some specifications of the Product may be changed without any notice. When in doubt, special part numbers may be assigned to fix or establish key specifications for your application. Please consult with your Omron's representative at any time to confirm actual specifications of purchased Product.

Errors and Omissions.

Information presented by Omron Companies has been checked and is believed to be accurate; however, no responsibility is assumed for clerical, typographical or proofreading errors or omissions.

OMRON Corporation Industrial Automation Company
Kyoto, JAPAN

Contact: www.ia.omron.com

Regional Headquarters

OMRON EUROPE B.V.

Wegalaan 67-69, 2132 JD Hoofddorp
The Netherlands
Tel: (31)2356-81-300/Fax: (31)2356-81-388

OMRON ELECTRONICS LLC

2895 Greenspoint Parkway, Suite 200
Hoffman Estates, IL 60169 U.S.A.
Tel: (1) 847-843-7900/Fax: (1) 847-843-7787

OMRON ASIA PACIFIC PTE. LTD.

No. 438A Alexandra Road # 05-05/08 (Lobby 2),
Alexandra Technopark,
Singapore 119967
Tel: (65) 6835-3011/Fax: (65) 6835-2711

OMRON (CHINA) CO., LTD.

Room 2211, Bank of China Tower,
200 Yin Cheng Zhong Road,
PuDong New Area, Shanghai, 200120, China
Tel: (86) 21-5037-2222/Fax: (86) 21-5037-2200

Authorized Distributor:

© OMRON Corporation 2020 All Rights Reserved.
In the interest of product improvement,
specifications are subject to change without notice.

CSM_1_1

Cat. No. F109-E1-01

0920 (0920)