

LOC		DIST		REVISIONS			
P	LTR	DESCRIPTION	DATE	DWN	APVD		
	B	REVISED PER ECO-17-005660	21APR2017	B. J	S. Y		

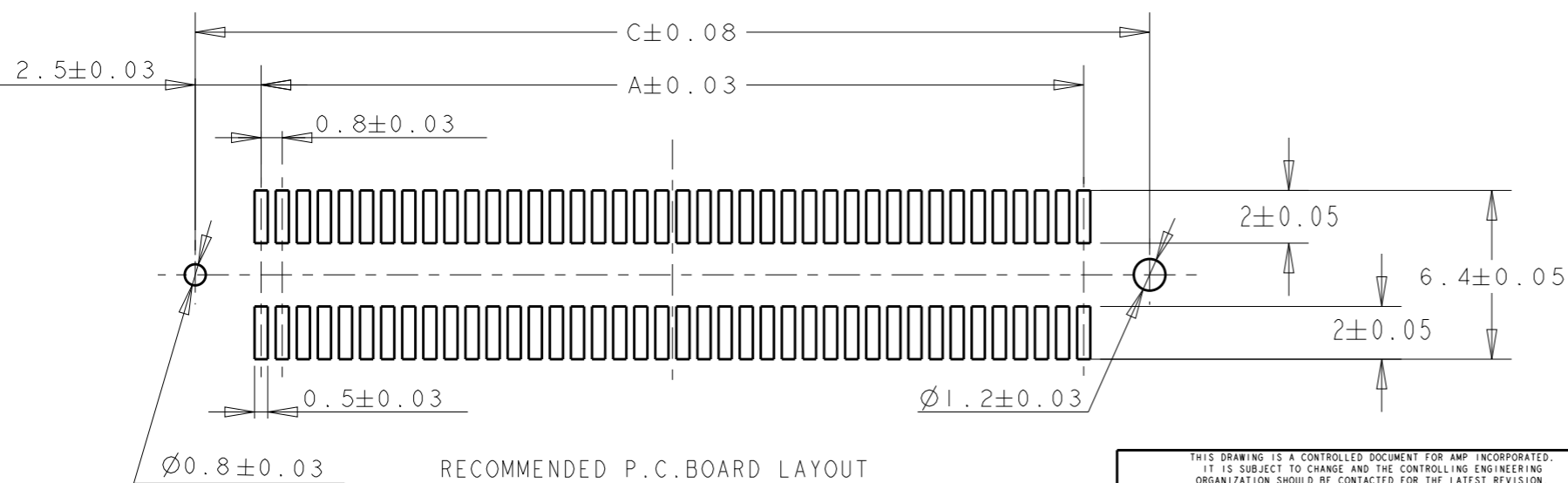
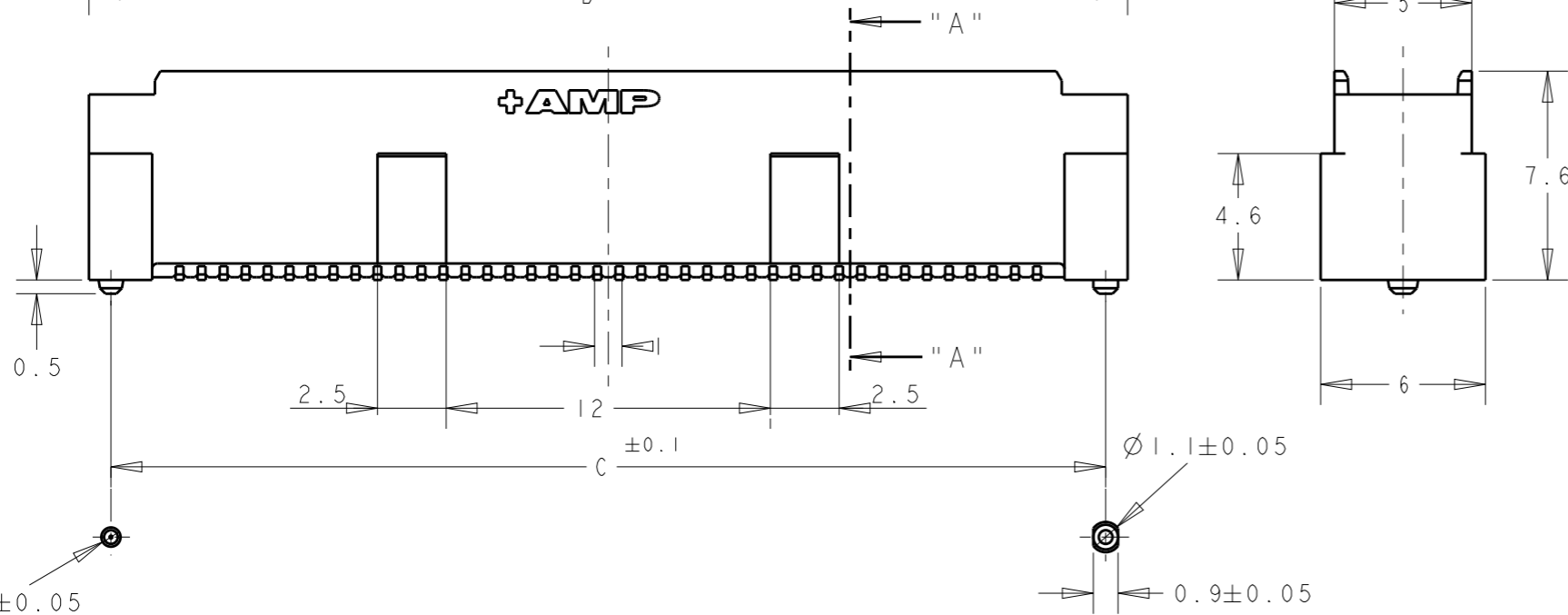
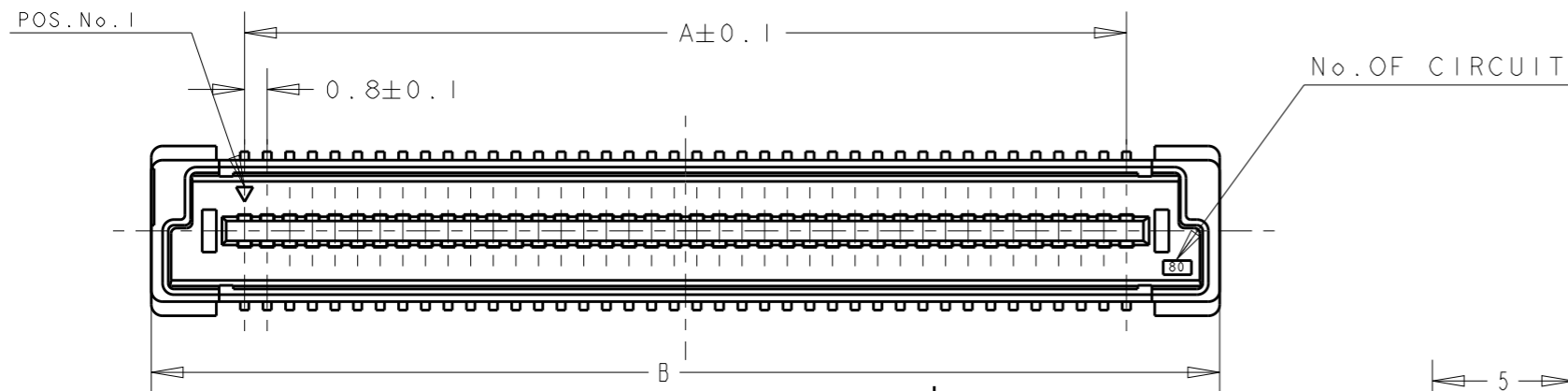

LOW HALOGEN

NOTES:

- 1. MATERIAL:  
HOUSING: L.C.P. (HIGH TEMP. THERMOPLASTIC)  
UL 94V-0, NATURAL.  
CONTACT: BRASS.
- 2. FINISH:  
CONTACT AREA: 0.00076 MIN GOLD ON  
0.0013 MIN ALL OVER NICKEL.  
SOLDERING AREA: 0.002 MIN MATTE-TIN.
- 3. POSITION SERIES: SEE TABLE.
- 4. CONN STACK HEIGHT COMBINE OF PLUG "Y" H VS REC "X" H.  
STACK HEIGHT = Y + X - 5
- 5. CONNECTOR WITH BLACK HOUSING

P/N SEE SHEET 2 OF 2

THIS DRAWING IS A CONTROLLED DOCUMENT FOR AMP INCORPORATED. IT IS SUBJECT TO CHANGE AND THE CONTROLLING ENGINEERING ORGANIZATION SHOULD BE CONTACTED FOR THE LATEST REVISION.		DWN FLORENCE TAN 14SEP04	Tyco Electronics Singapore
DIMENSIONS: mm		CHK ERIC TNG	
TOLERANCES UNLESS OTHERWISE SPECIFIED: 0 PLC ±0.30 1 PLC ±0.30 2 PLC ±0.25 3 PLC ±0.20 4 PLC ±0.20 ANGLES ±3°		APVD SEIFONG	NAME PLUG ASSY FOR FH 0.8 BTB CONNECTOR 8H 0.5 BOSS LENGTH (0.76um GOLD)
MATERIAL	FINISH	PRODUCT SPEC 108-5390	SIZE A3
		APPLICATION SPEC 114-5254	CAGE CODE 00779
		WEIGHT -	DRAWING NO 6123002
CUSTOMER DRAWING		SCALE 4:1 SHEET 1 OF 2 REV B	

THIS DRAWING IS UNPUBLISHED. RELEASED FOR PUBLICATION .19 .  
 BY AMP INCORPORATED. ALL RIGHTS RESERVED.

LOC	DIST	REVISIONS					
DY	-	P	LTR	DESCRIPTION	DATE	DWN	APVD
		-		SEE SHT 1 OF 2	-	-	-

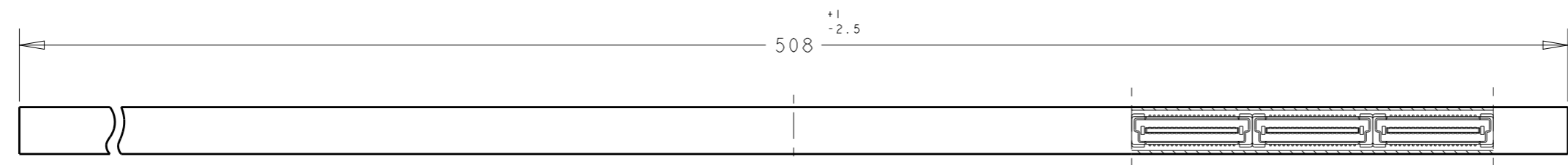

SECT A-A



SECT B-B

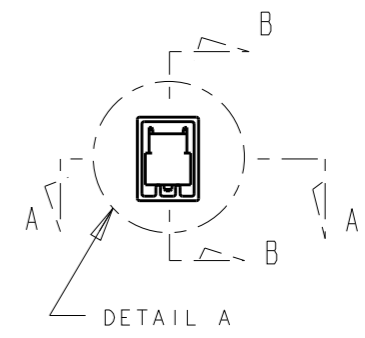

REFERENCE PICTURE OF TUBE PACK

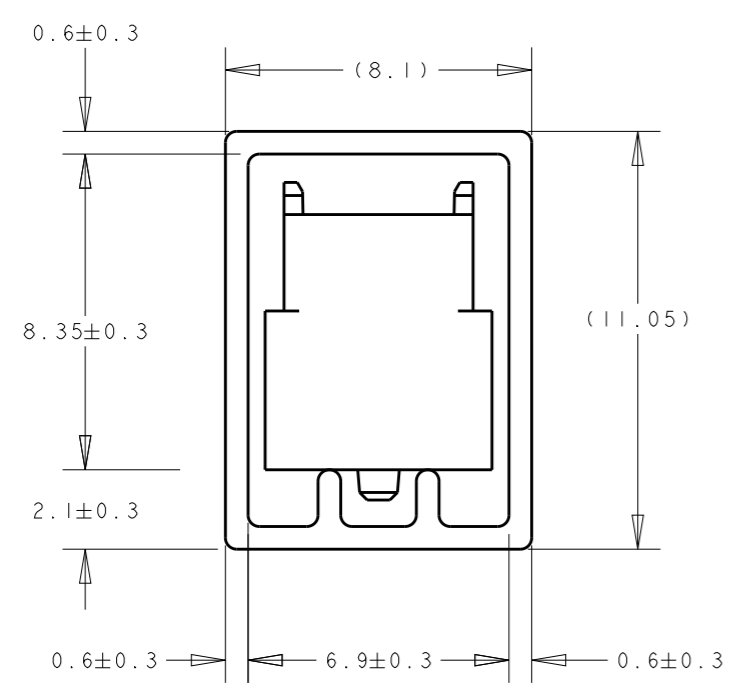

DETAIL "B"  
(SCALE 5-1)

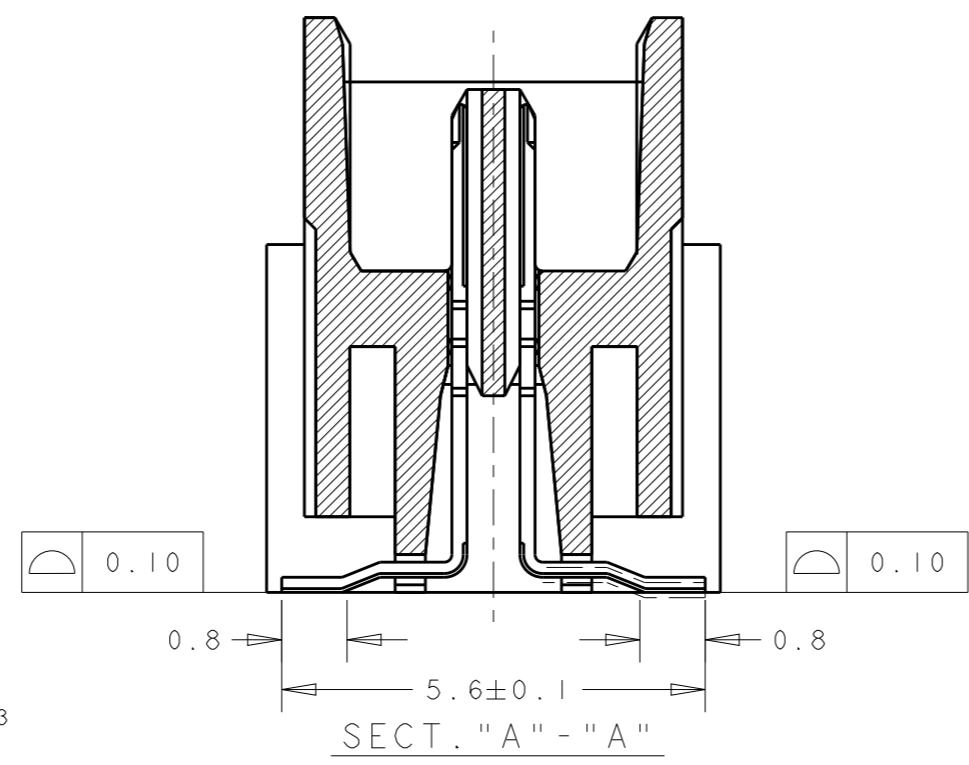

SECT. "A" - "A"

5	AVAILABLE	16	28.2	29.8	23.2	60	2-	-1
	NOT AVAILABLE	14	32.2	33.8	27.2	70	1-	-1
	AVAILABLE	5	84.2	85.8	79.2	200	1-	-0
		6	76.2	77.8	71.2	180		-9
		6	68.2	69.8	63.2	160		-8
		7	60.2	61.8	55.2	140		-6
		9	52.2	53.8	47.2	120		-5
		10	44.2	45.8	39.2	100		-4
		12	36.2	37.8	31.2	80		-3
		16	28.2	29.8	23.2	60		-2
22	20.2	21.8	15.2	40		6123002-1		
STATUS	QTY/TUBE	C	B	A	POS.	CONN P/N		

LOW HALOGEN

THIS DRAWING IS A CONTROLLED DOCUMENT FOR AMP INCORPORATED. IT IS SUBJECT TO CHANGE AND THE CONTROLLING ENGINEERING ORGANIZATION SHOULD BE CONTACTED FOR THE LATEST REVISION.

DWN 13SEP04  
FLORENCE TAN  
CHK ERIC TNG  
APVD SEIFONG  
PRODUCT SPEC 108-5390  
APPLICATION SPEC 114-5254  
WEIGHT -

**AMP** Tyco Electronics Singapore  
NAME PLUG ASSY FOR FH 0.8 BTB CONNECTOR 8H 0.5 BOSS LENGTH (0.76um GOLD)  
SIZE A3 CAGE CODE 00779 DRAWING NO C-6123002

MATERIAL 1 FINISH 2

CUSTOMER DRAWING SCALE 4:1 SHEET 2 OF 2 REV B