

Data sheet | Item number: 2020-112

1-conductor female connector; Push-in CAGE CLAMP®; 1.5 mm²; Pin spacing 3.5 mm; 12-pole; 1,50 mm²; gray

www.wago.com/2020-112

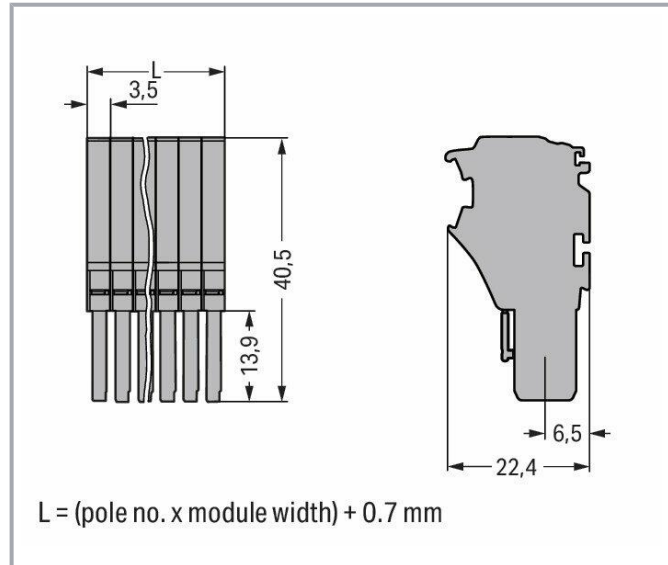
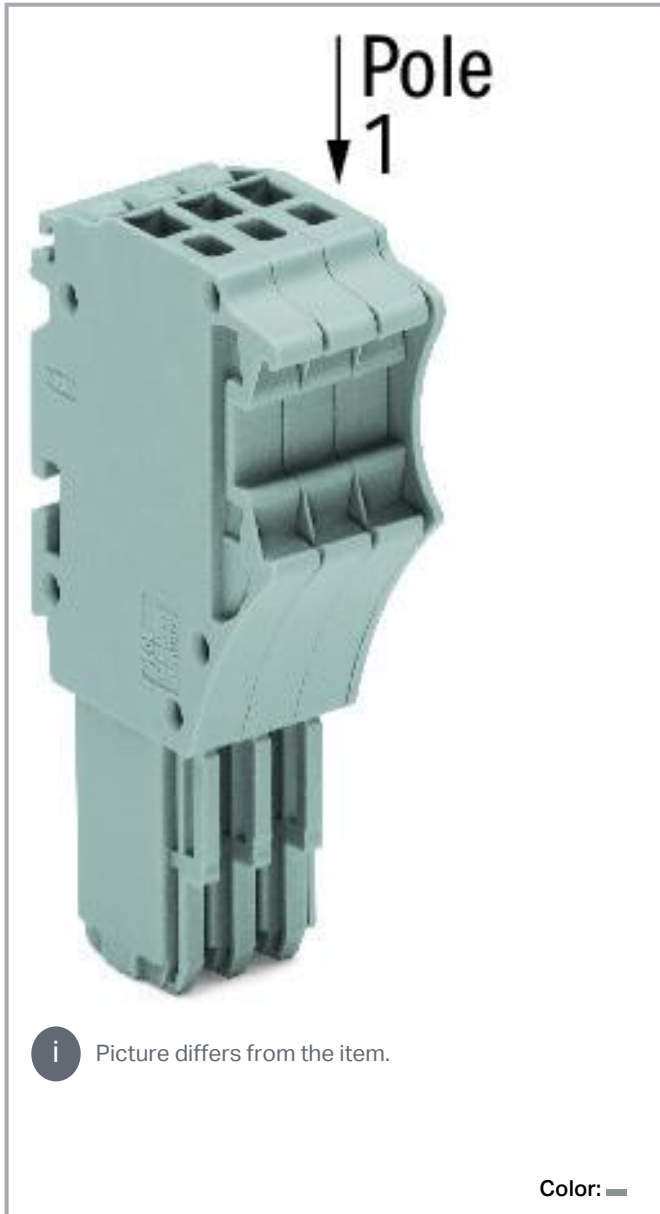

Subject to changes. Please also observe the further product documentation!

WAGO GmbH & Co. KG
Hansastr. 27
32423 Minden
Phone: +49571 887-0 | Fax: +49571 887-169
Email: info.de@wago.com | Web: www.wago.com

Do you have any questions about our products?
We are always happy to take your call at +49 (571) 887-44222.



Data

Notes

Safety information

According to EN 61984, pluggable connectors without current interrupting capacity must not be mated or unmated when live or under load.

Safety information 2

Notice: An appropriate end plate must be applied to the carrier terminal blocks after each female plug.

Electrical data

Ratings per IEC/EN

| Ratings per | IEC/EN 61984 |
|-------------------------------|---|
| Nominal voltage (III/3) | 500 V |
| Rated impulse voltage (III/3) | 6 kV |
| Rated current | 13.5 A |
| Legend (ratings) | (III / 3) ≙ Overvoltage category III / Pollution degree 3 |

Ratings per UL 1059

| Approvals per | UL 1059 |
|--------------------------------|---------|
| Rated voltage UL (Use Group B) | 300 V |
| Rated current UL (Use Group B) | 15 A |
| Rated voltage UL (Use Group C) | 300 V |
| Rated current UL (Use Group C) | 15 A |
| Rated voltage UL (Use Group D) | 300 V |
| Rated current UL (Use Group D) | 15 A |

Ratings per CSA

| Approvals per | CSA 22.2 No 158 |
|---------------------------------|-----------------|
| Rated voltage CSA (Use Group B) | 300 V |
| Rated current CSA (Use Group B) | 10 A |
| Rated voltage CSA (Use Group C) | 300 V |
| Rated current CSA (Use Group C) | 10 A |
| Rated voltage CSA (Use Group D) | 300 V |
| Rated current CSA (Use Group D) | 10 A |

Subject to changes. Please also observe the further product documentation!

WAGO GmbH & Co. KG
 Hansastr. 27
 32423 Minden
 Phone: +49571 887-0 | Fax: +49571 887-169
 Email: info.de@wago.com | Web: www.wago.com

Do you have any questions about our products?
 We are always happy to take your call at +49 (571) 887-44222.



Connection data

| | |
|----------------------------|----|
| Connection points | 12 |
| Total number of potentials | 12 |

Connection 1

| | |
|--|---|
| Connection technology | Push-in CAGE CLAMP® |
| Actuation type | Operating tool |
| Connectable conductor materials | Copper |
| Nominal cross-section | 1 mm ² |
| Solid conductor | 0.14 ... 1.5 mm ² / 24 ... 16 AWG |
| Solid conductor; push-in termination | 0.5 ... 1.5 mm ² / 20 ... 16 AWG |
| Fine-stranded conductor | 0.14 ... 1.5 mm ² / 24 ... 16 AWG |
| Fine-stranded conductor; with insulated ferrule | 0.14 ... 0.75 mm ² / 24 ... 18 AWG |
| Fine-stranded conductor; with ferrule; push-in termination | 0.5 ... 0.75 mm ² / 20 ... 18 AWG |
| Note (conductor cross-section) | Depending on the conductor characteristic, a conductor with a smaller cross-section can also be inserted via push-in termination. |
| Strip length | 9 ... 11 mm / 0.35 ... 0.43 inches |
| Pole number | 12 |
| Wiring direction | Front-entry wiring |

Physical data

| | |
|--------------|------------------------|
| Width | 42.7 mm / 1.681 inches |
| Height | 40.5 mm / 1.594 inches |
| Depth | 22.4 mm / 0.882 inches |
| Module width | 3.5 mm / 0.138 inches |

Mechanical Data

| | |
|--------------------------|--------------|
| Variable coding | Yes |
| Marking level | Side marking |
| Anti-rotation protection | Yes |

Plug-in connection

| | |
|------------------------------------|-------------------------|
| Contact type (pluggable connector) | Female connector/socket |
| Connector (connection type) | for conductor |
| Mismating protection | No |

Subject to changes. Please also observe the further product documentation!



| | |
|--------------------------------------|----|
| Plugging without loss of pin spacing | No |
|--------------------------------------|----|

Material Data

Note (material data)

Information on material specifications can be found here

| | |
|-----------------------------|------------------|
| Color | gray |
| Material group | I |
| Insulation material | Polyamide (PA66) |
| Flammability class per UL94 | V0 |
| Fire load | 0.481 MJ |
| Weight | 27.1 g |

Environmental requirements

| | |
|----------------------------------|-----------------|
| Processing temperature | -35 ... +85 °C |
| Continuous operating temperature | -60 ... +105 °C |

Commercial data

| | |
|-----------------------|---------------|
| eCl@ss 10.0 | 27-14-11-06 |
| eCl@ss 9.0 | 27-14-11-06 |
| ETIM 8.0 | EC001284 |
| ETIM 7.0 | EC001284 |
| PU (SPU) | 20 pcs |
| Packaging type | Box |
| Country of origin | CN |
| GTIN | 4050821245100 |
| Customs tariff number | 85366990990 |

Environmental Product Compliance

| | |
|------------------------|-------------------------|
| RoHS Compliance Status | Compliant, No Exemption |
|------------------------|-------------------------|

Approvals / Certificates

General approvals

| Logo | Approval | Additional Approval Text | Certificate name |
|------|---------------------------------|--------------------------|------------------|
| | CCA DEKRA Certification B.V. | EN 60947 | NTR NL 7617 |

Subject to changes. Please also observe the further product documentation!

WAGO GmbH & Co. KG
 Hansastr. 27
 32423 Minden
 Phone: +49571 887-0 | Fax: +49571 887-169
 Email: info.de@wago.com | Web: www.wago.com

Do you have any questions about our products?
 We are always happy to take your call at +49 (571) 887-44222.

CCA



CSA
DEKRA Certification B.V.

C22.2

2516073





UL
UL International Germany GmbH



UL 1059

E 45172

Declarations of conformity and manufacturer's declarations

| Logo | Approval | Additional Approval Text | Certificate name |
|---|--|--------------------------|------------------|
|  | EU-Declaration of Conformity WAGO GmbH & Co. KG | - | - |
|  | UK-Declaration of Conformity WAGO GmbH & Co. KG | - | - |

Approvals for marine applications

| Logo | Approval | Additional Approval Text | Certificate name |
|---|------------------------------------|--------------------------|--------------------------|
|  | ABS American Bureau of Shipping | EN 60947 | 20- HG1941090- PDA |
|  | BV Bureau Veritas S.A. | EN 60947 | 38586/BO BV |

Optional accessories

Tool

Operating tool

| | | |
|---|---|--|
|  | Item no.: 210-648 Operating tool; Blade: 2.5 x 0.4 mm; with a partially insulated shaft; angled; short | www.wago.com/210-648 |
|---|---|--|

Subject to changes. Please also observe the further product documentation!

| | | |
|---|--|--|
|  | Item no.: 210-647 Operating tool; Blade: 2.5 x 0.4 mm; with a partially insulated shaft; multicoloured | www.wago.com/210-647 |
|---|--|--|

| | | |
|--|---|--|
|  | Item no.: 210-719 Operating tool; Blade: 2.5 x 0.4 mm; with a partially insulated shaft | www.wago.com/210-719 |
|--|---|--|

Strain relief

Strain relief plate

| | | |
|--|---|--|
|  | Item no.: 734-326 Strain relief plate; for female and male connectors; 35 mm wide; 1 part; gray | www.wago.com/734-326 |
|--|---|--|

Ferrule

Ferrule

| | | |
|---|--|--|
|  | Item no.: 216-241 Ferrule; Sleeve for 0.5 mm ² / 20 AWG; insulated; electro-tin plated; electrolytic copper; gastight crimped; acc. to DIN 46228, Part 4/09.90; white | www.wago.com/216-241 |
|---|--|--|

| | | |
|---|--|--|
|  | Item no.: 216-242 Ferrule; Sleeve for 0.75 mm ² / 18 AWG; insulated; electro-tin plated; electrolytic copper; gastight crimped; acc. to DIN 46228, Part 4/09.90; gray | www.wago.com/216-242 |
|---|--|--|

| | | |
|---|--|--|
|  | Item no.: 216-243 Ferrule; Sleeve for 1 mm ² / AWG 18; insulated; electro-tin plated; electrolytic copper; gastight crimped; acc. to DIN 46228, Part 4/09.90; red | www.wago.com/216-243 |
|---|--|--|

Protective warning marker

Cover

| | | |
|--|--|--|
|  | Item no.: 2000-115 Protective warning marker; for 5 terminal blocks; with high-voltage symbol, black; yellow | www.wago.com/2000-115 |
|--|--|--|

Marking accessories

Marking strip

| | | |
|--|--|--|
|  | Item no.: 2009-110 Marking strips; for Smart Printer; on reel; not stretchable; plain; snap-on type; white | www.wago.com/2009-110 |
|--|--|--|

| | | |
|--|---|--|
|  | Item no.: 210-831 Marking strips; on reel; 2.3 mm wide; plain; Self-adhesive; white | www.wago.com/210-831 |
|--|---|--|

| | | |
|--|--|--|
|  | Item no.: 210-833 Marking strips; 25 m on roll; 6 mm wide; plain; Self-adhesive; white | www.wago.com/210-833 |
|--|--|--|

| | | |
|--|---|--|
|  | Item no.: 210-834 Marking strips; on reel; 5 mm wide; plain; Self-adhesive; white | www.wago.com/210-834 |
|--|---|--|

| | | |
|--|---|--|
|  | Item no.: 210-832 Marking strips; on reel; 3 mm wide; plain; Self-adhesive; white | www.wago.com/210-832 |
|--|---|--|

Marker

Subject to changes. Please also observe the further product documentation!



Item no.: 2009-113
WMB-Inline; for Smart Printer; 2300 pieces on roll; plain; snap-on type; white

www.wago.com/2009-113



Item no.: 793-3501
WMB marking card; as card; plain; snap-on type; white

www.wago.com/793-3501

Locking levers

Locking system



Item no.: 2022-151
Locking lever; gray

www.wago.com/2022-151



Item no.: 2022-152
Locking lever; orange

www.wago.com/2022-152

Downloads

Documentation

Bid Text

| | | | |
|--------------------------|-------------|-----------------|----------|
| 2020-112 X81 - Datei | 2019 Feb 19 | xml 4.0 kB | Download |
| 2020-112 docx - Datei | 2018 Aug 6 | docx 15.4 kB | Download |

Additional Information

| | | | |
|---|--|---------------|----------|
| Technical Section Technical explanations | | pdf 2.2 MB | Download |
|---|--|---------------|----------|

CAD/CAE-Data

CAE data

| | | | |
|----------------------------|--|-----|----------|
| EPLAN Data Portal 2020-112 | | URL | Download |
| WSCAD Universe 2020-112 | | URL | Download |
| ZUKEN Portal 2020-112 | | URL | Download |

CAD data

| | | | |
|-----------------------|--|-----|----------|
| 2D/3D Models 2020-112 | | URL | Download |
|-----------------------|--|-----|----------|

Subject to changes. Please also observe the further product documentation!

WAGO GmbH & Co. KG
Hansastr. 27
32423 Minden
Phone: +49571 887-0 | Fax: +49571 887-169
Email: info.de@wago.com | Web: www.wago.com

Do you have any questions about our products?
We are always happy to take your call at +49 (571) 887-44222.

Environmental Product Compliance

Compliance Search

Environmental Product Compliance 2020-112

URL

Download

1-conductor female connector; Push-in CAGE CLAMP®; 1.5 mm²; Pin spacing 3.5 mm;
12-pole; 1,50 mm²; gray

Installation Notes

Coding

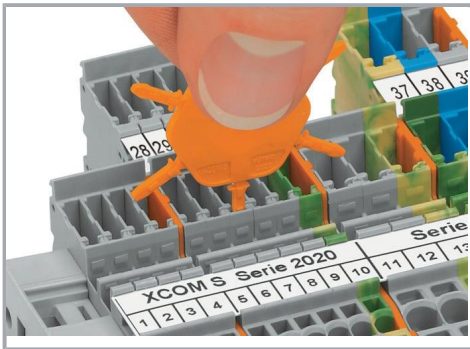

Insert coding pin into the corresponding slot and twist it off.



Coding a female plug: remove coding finger using a suitable tool.

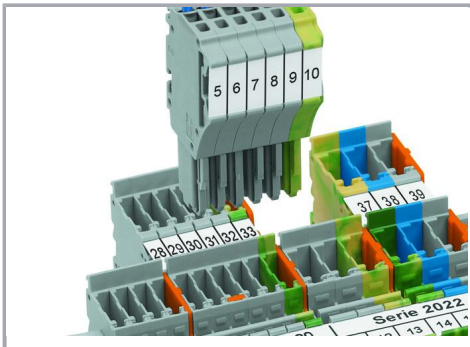

Insert coded female plug into X-COM®S-SYSTEM terminal block assembly.

Locking system

Subject to changes. Please also observe the further product documentation!

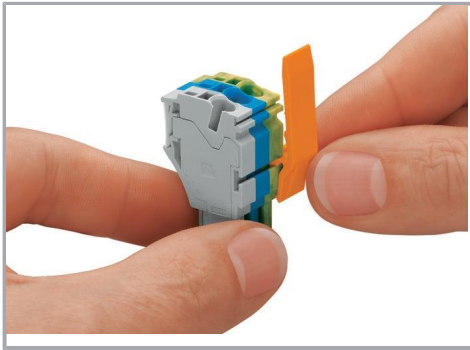

Slide the locking lever into position.

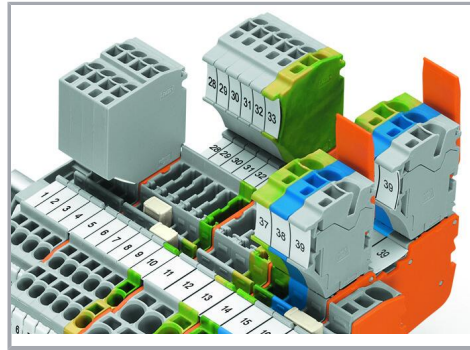

Female plugs can be individually locked.

Product family

X-COM S-Mini

[Show all products from the family](#)

Subject to changes. Please also observe the further product documentation!

WAGO GmbH & Co. KG
Hansastr. 27
32423 Minden
Phone: +49571 887-0 | Fax: +49571 887-169
Email: info.de@wago.com | Web: www.wago.com

Do you have any questions about our products?
We are always happy to take your call at +49 (571) 887-44222.