

Housing - HC-ADV-B24-HHWH-1STM40-EMC-AL - 1413433

Please be informed that the data shown in this PDF Document is generated from our Online Catalog. Please find the complete data in the user's documentation. Our General Terms of Use for Downloads are valid (<http://phoenixcontact.com/download>)



HEAVYCON ADVANCE sleeve housing, B24, with stainless steel screw locking (Allen screw), salt-water-resistant aluminum, height 93.7 mm, with thread, 1 x M40 lateral cable outlet, without surface; conductive seal (EMC properties)



Key Commercial Data

Packing unit	1 pc
GTIN	 4 055626 030463
GTIN	4055626030463

Technical data

Dimensions

Height	93.7 mm
Width	57 mm
Length	152 mm
Length of the assembly cutout	112 mm
Width of the assembly cutout	35 mm

Ambient conditions

Degree of protection of housing (IP)	IP66
	IP68 (0.2 bar/24 h)
	IP69K (ISO 20653:2013-02)
Degree of protection of housing (NEMA)	4 (UL 50e)
	4X (UL 50e)
	12 (UL 50e)
Ambient temperature (operation)	-40 °C ... 125 °C

General

Note	for contact inserts HC-B24, BB46, D64, DD108, HV10/16, M
------	--

Housing - HC-ADV-B24-HHWH-1STM40-EMC-AL - 1413433

Technical data

General

Size	B24
Housing type	Sleeve housing
Color	gray aluminum
Locking type	Screw locking
Torque	3 Nm (Locking screw)
Fixing screws	M6 (screw head: 5 mm Allen screw)
No. of cable outlets	1
Cable outlet	lateral
Screw connection	none
Type of the screw connection	1x M40
Housing material	Die-cast aluminum, salt water resistant
Housing surface material	uncoated
Seal material	NBR, conductive
Material lock	Stainless steel
Assembly instructions	In order to guarantee that the ground conductor contact functions even when plugged in at an angle, the two panel mounting flanges must have sufficient electrical contact with the metal mounting panel.
Connection	To ensure optimum shielding, any insulating power coating must be removed from the profile gasket area on the control cabinet panel. Tightening torque of locking screw: 3 Nm.

Environmental Product Compliance

China RoHS	Environmentally friendly use period: unlimited = EFUP-e
	No hazardous substances above threshold values

Drawings

Housing - HC-ADV-B24-HHWH-1STM40-EMC-AL - 1413433

Dimensional drawing

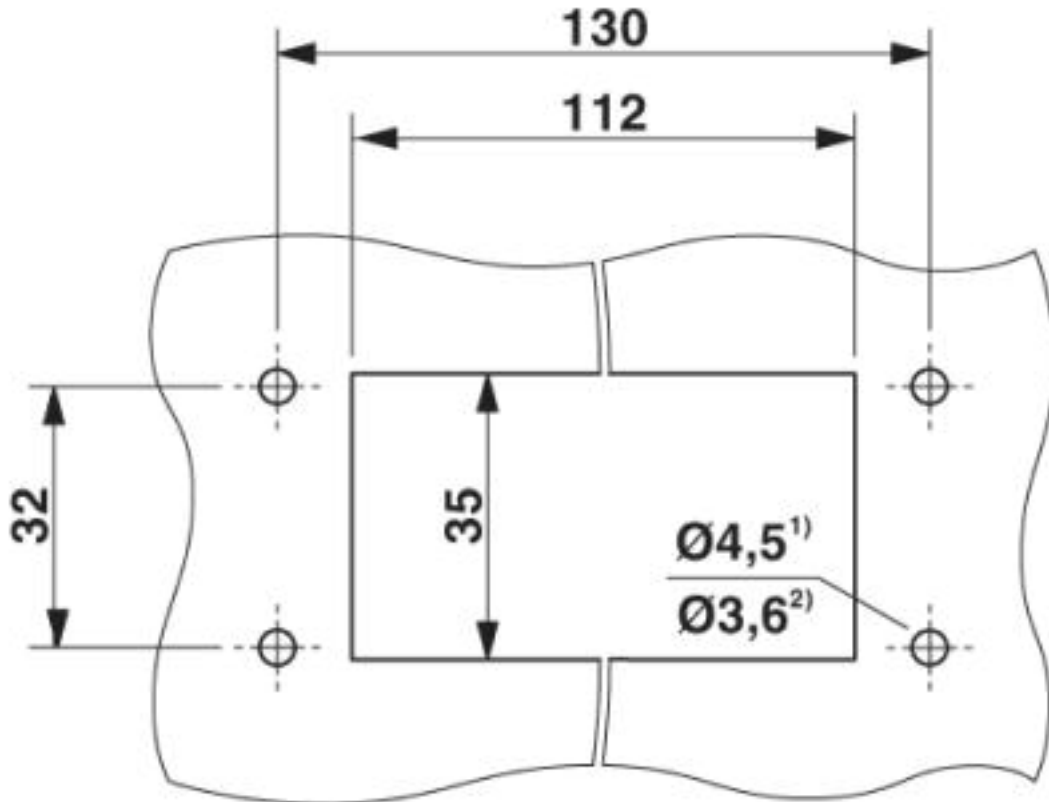

Mounting cutout

1) when M4 screws are used

2) when self-tapping Torx® screws are used (Torx® 20, M4)

Dimensional drawing

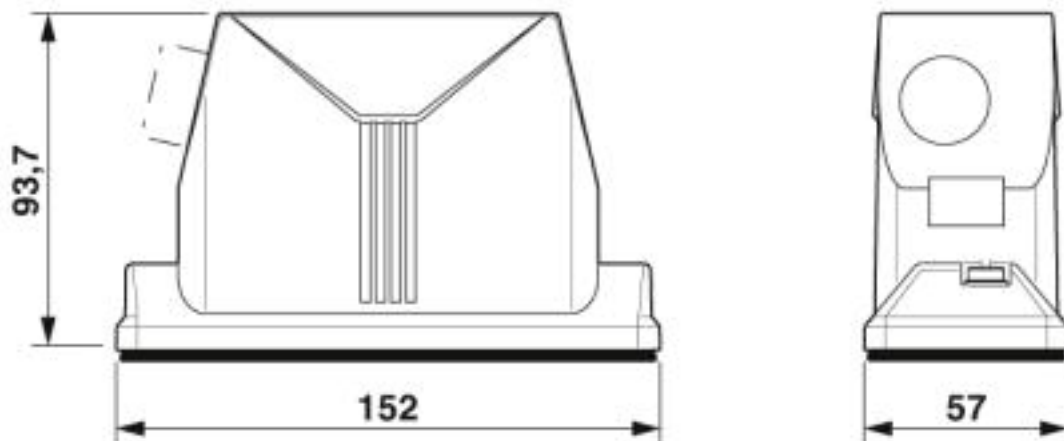

Dimensional drawing

Housing - HC-ADV-B24-HHWH-1STM40-EMC-AL - 1413433

Approvals





Approvals

Approvals

UL Recognized / cUL Recognized / EAC / DNV GL / cULus Recognized

Ex Approvals

Approval details

UL Recognized		http://database.ul.com/cgi-bin/XYV/template/LISEXT/1FRAME/index.htm	E255026
cUL Recognized		http://database.ul.com/cgi-bin/XYV/template/LISEXT/1FRAME/index.htm	E255026
EAC			RU C- DE.AI30.B.01102
DNV GL		https://approvalfinder.dnvgl.com/	TAE000037S
cULus Recognized			

Phoenix Contact 2019 © - all rights reserved
<http://www.phoenixcontact.com>

PHOENIX CONTACT GmbH & Co. KG
Flachsmarktstr. 8
32825 Blomberg
Germany
Tel. +49 5235 300
Fax +49 5235 3 41200
<http://www.phoenixcontact.com>