

# MSI1380 series

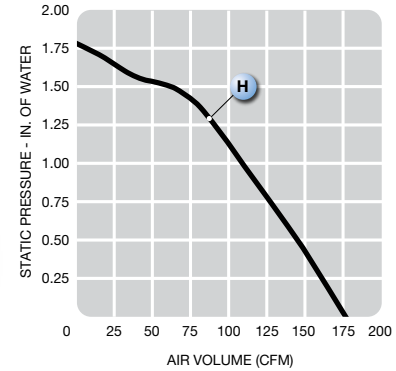
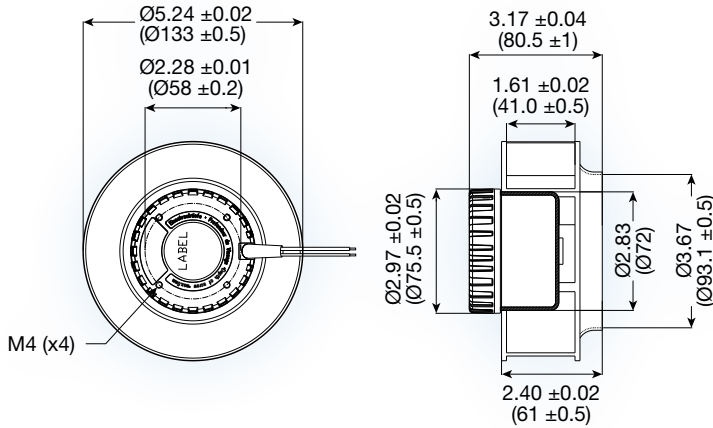

**(133 dia. x 80 mm)**

5.24 dia. x 3.17 inches

Features: soft start, reverse polarity protection, auto-restart

Operating Voltage: 24 or 48 VDC

Construction: aluminum die cast motor base; UL94V-0 plastic impeller

Bearing option: ball bearing

Motor: brushless DC

Model No.	Rated Voltage VDC	Current A		Speed RPM	Air Volume		Max. Static Pressure (H <sub>2</sub> O)		Sound Noise dba	Weight g
		24	48		M <sup>3</sup> /Min.	CFM	MM	INCH		
<b>MSI1380H</b>	24/48	5.00	2.50	4,500	5.0	177	45.32	1.78	66	800

