

## LISA2-WW-PIN

~45° wide beam. 6.8 mm high variant with location pin installation.

### SPECIFICATION:

Dimensions	Ø 9.9 mm
Height	6.8 mm
Fastening	glue, pin
ROHS compliant	yes ⓘ



### MATERIALS:

Component	Type	Material	Colour	Finish
LISA2-WW	Single lens	PMMA	clear	
LISA2-HLD-PIN	Holder	PC	black	

### ORDERING INFORMATION:

Component		Qty in box	MOQ	MPQ	Box weight (kg)
FP13026_LISA2-WW-PIN	Single lens	2000		100	1.4
» Box size:					

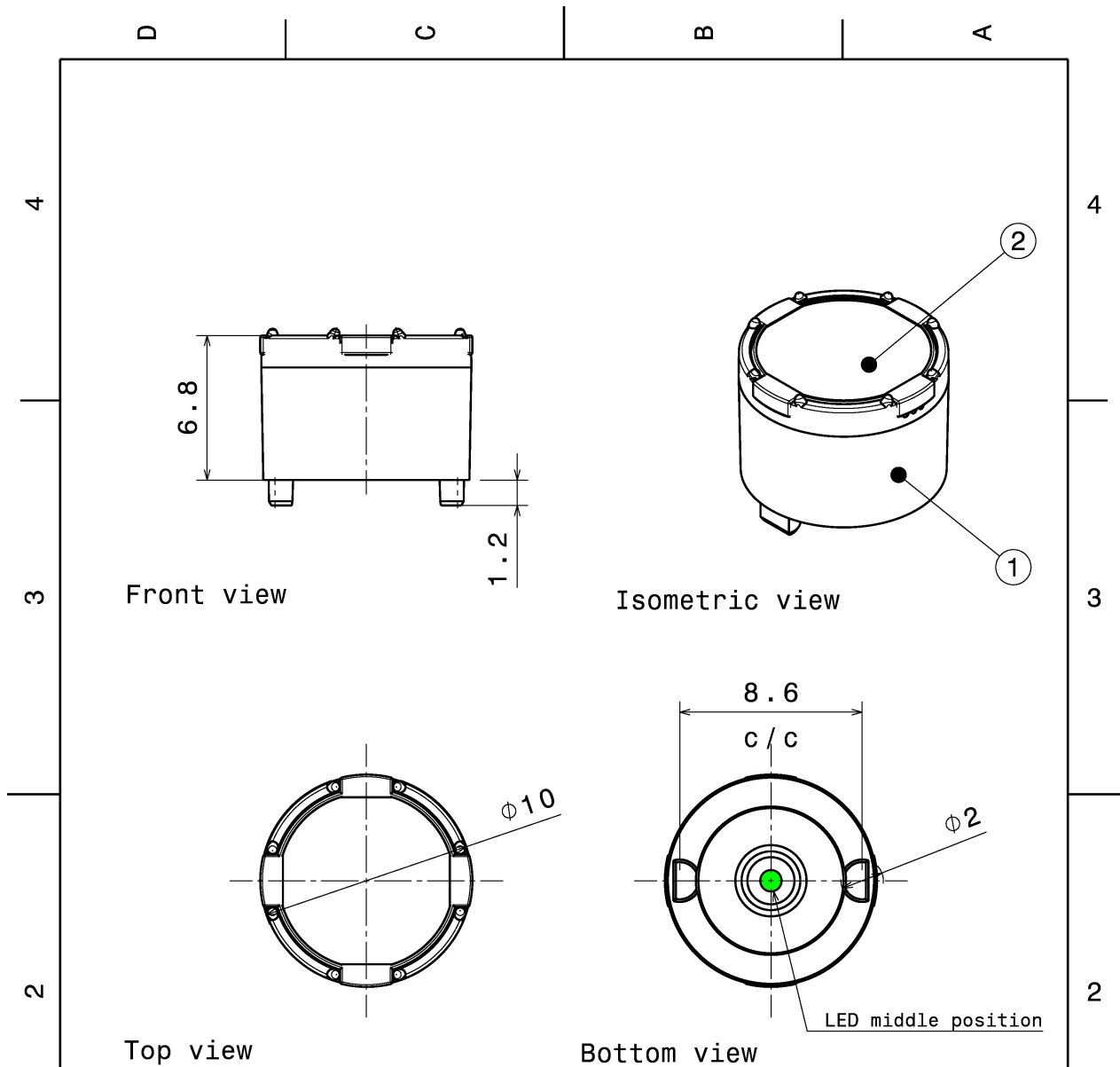

INDEX	PART NO	DESCRIPTION	MATERIAL	COLOUR
1	F10989	LISA2-HLD-PIN	PC	black
2	-	LISA2_lens	PMMA	

Tolerances if not otherwise shown  
According to DIN ISO 2768-1  
Linear measures:  
up to 30mm class M, otherwise class C  
According to DIN ISO 2768-2  
Form and position: class L

**LEDiL** Ledil Oy  
Salorankatu 10  
FIN 24240 SALO  
Finland

THIRD ANGLE PROJECTION:

DRAWING TITLE  
**Lisa2-PIN-XP assembly**







This drawing is the property of LEDiL Oy. It may not be reproduced, copied or communicated without a written agreement with LEDiL Oy.

SIZE	PART NUMBER
A4	-

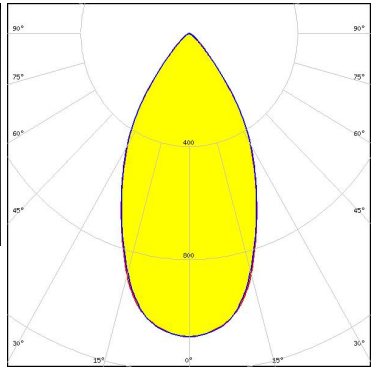
SCALE	4:1	WEIGHT	0,5 g	SHEET	1/1
-------	-----	--------	-------	-------	-----

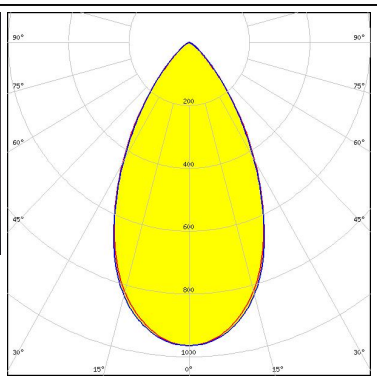
See also our general installation guide: [www.ledil.com/installation\\_guide](http://www.ledil.com/installation_guide)

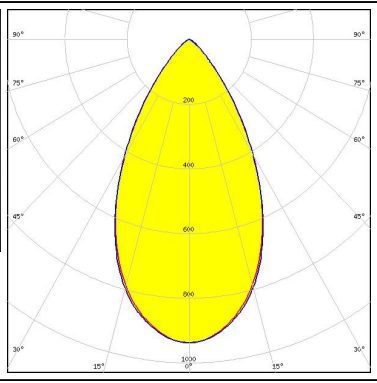
#### OPTICAL RESULTS (MEASURED):

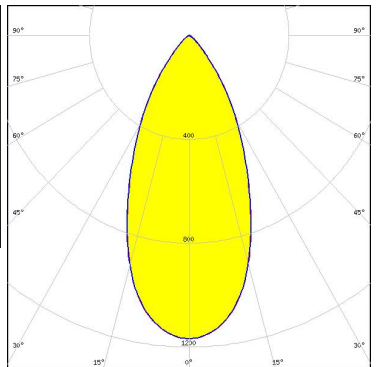
<p><b>CREE → LED</b></p> <p>LED            XP-E2            FWHM / FWTM    53.0° / 87.0°            Efficiency        91 %            Peak intensity    1.1 cd/lm            LEDs/each optic    1            Light colour      White            Required components:</p>		
<p><b>CREE → LED</b></p> <p>LED            XP-G2            FWHM / FWTM    57.0° / 90.0°            Efficiency        90 %            Peak intensity    1 cd/lm            LEDs/each optic    1            Light colour      White            Required components:</p>		
<p><b>CREE → LED</b></p> <p>LED            XP-G3            FWHM / FWTM    56.0° / 90.0°            Efficiency        85 %            Peak intensity    0.9 cd/lm            LEDs/each optic    1            Light colour      White            Required components:</p>		
<p><b>CREE → LED</b></p> <p>LED            XT-E            FWHM / FWTM    48.0° / 83.0°            Efficiency        85 %            Peak intensity    1.2 cd/lm            LEDs/each optic    1            Light colour      White            Required components:</p>		

#### OPTICAL RESULTS (MEASURED):



LED NCSxx19B  
 FWHM / FWTM 45.0° / 82.0°  
 Efficiency 85 %  
 Peak intensity 1.2 cd/lm  
 LEDs/each optic 1  
 Light colour White  
 Required components:

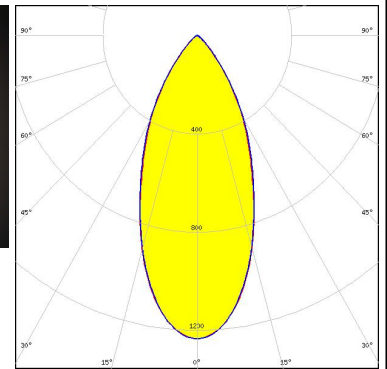
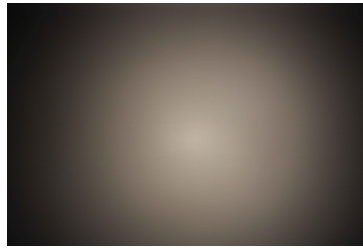

LED OSLOM Square EC  
 FWHM / FWTM 53.0° / 89.0°  
 Efficiency 84 %  
 Peak intensity 1 cd/lm  
 LEDs/each optic 1  
 Light colour White  
 Required components:

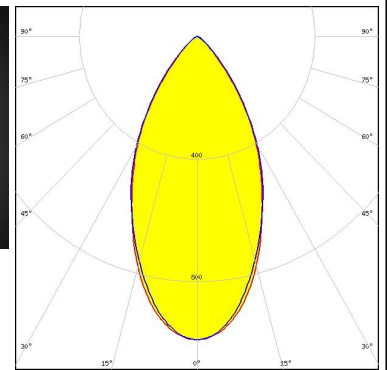
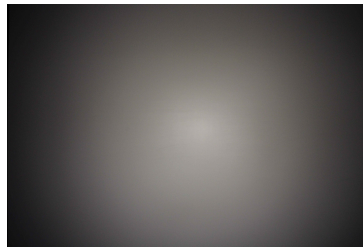

LED LH351Z  
 FWHM / FWTM 65.0° / 94.0°  
 Efficiency 91 %  
 Peak intensity 0.9 cd/lm  
 LEDs/each optic 1  
 Light colour White  
 Required components:

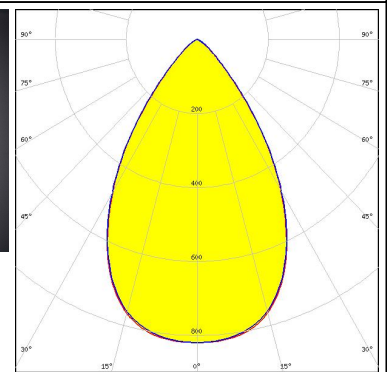
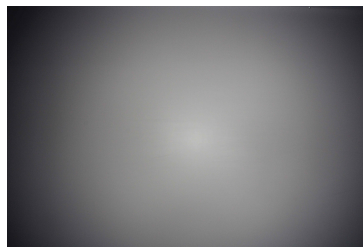

#### OPTICAL RESULTS (SIMULATED):

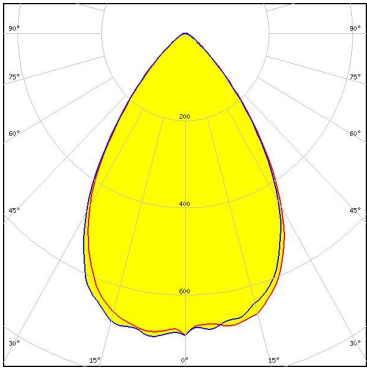
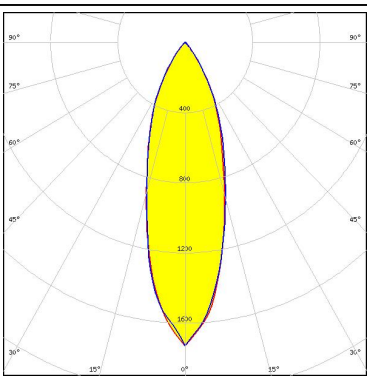
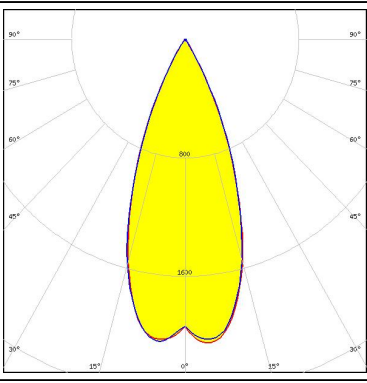
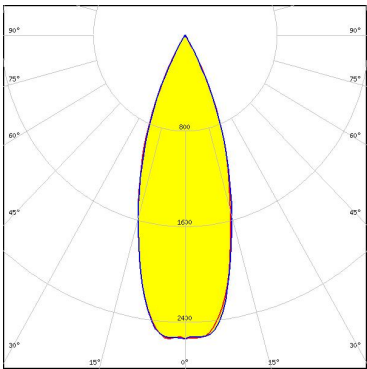
<p><b>CREE</b> LED</p> <p>LED: XP-G2 HE            FWHM / FWTM: 69.0° / 100.0°            Efficiency: 87 %            Peak intensity: 0.7 cd/lm            LEDs/each optic: 1            Light colour: White            Required components:</p>	
<p><b>LUMILEDS</b></p> <p>LED: LUXEON IR 2720            FWHM / FWTM: 31.0° / 70.0°            Efficiency: 74 %            Peak intensity: 1.7 cd/lm            LEDs/each optic: 1            Light colour: IR            Required components:</p>	
<p><b>LUMILEDS</b></p> <p>LED: LUXEON TX            FWHM / FWTM: 40.0° / 61.0°            Efficiency: 94 %            Peak intensity: 2.1 cd/lm            LEDs/each optic: 1            Light colour: White            Required components:</p>	
<p><b>LUMINUS</b></p> <p>LED: SST-20            FWHM / FWTM: 36.0° / 58.0°            Efficiency: 96 %            Peak intensity: 2.6 cd/lm            LEDs/each optic: 1            Light colour: White            Required components:</p>	

#### OPTICAL RESULTS (SIMULATED):



LED NCSxE17A  
 FWHM / FWTM 30.0° / 72.0°  
 Efficiency 86 %  
 Peak intensity 1.9 cd/lm  
 LEDs/each optic 1  
 Light colour White  
 Required components:



LED NVSW519A  
 FWHM / FWTM 60.0° / 96.0°  
 Efficiency 84 %  
 Peak intensity 0.8 cd/lm  
 LEDs/each optic 1  
 Light colour White  
 Required components:

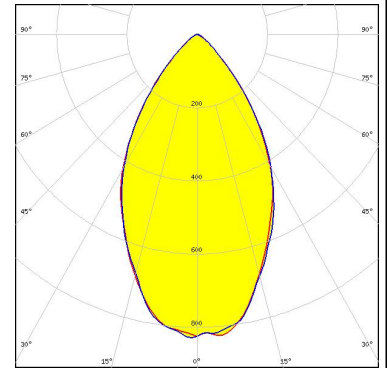

LED NVSxE21A  
 FWHM / FWTM 38.0° / 74.0°  
 Efficiency 84 %  
 Peak intensity 1.5 cd/lm  
 LEDs/each optic 1  
 Light colour White  
 Required components:



LED NVSxx19B/NVSxx19C  
 FWHM / FWTM 55.0° / 88.0°  
 Efficiency 88 %  
 Peak intensity 1 cd/lm  
 LEDs/each optic 1  
 Light colour White  
 Required components:

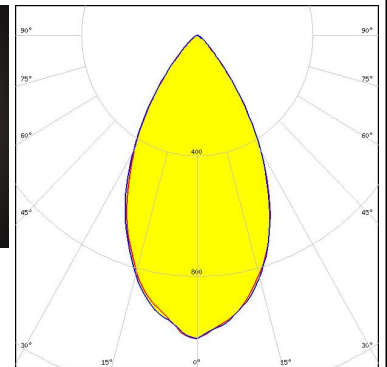
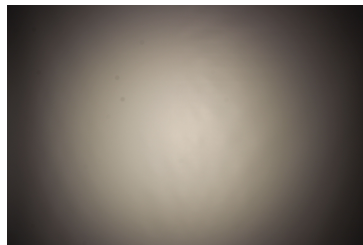

#### OPTICAL RESULTS (SIMULATED):

<p><b>OSRAM</b> Opto Semiconductors</p> <p>LED: OSLOM Black</p> <p>FWHM / FWTM: 36.0° / 78.0°</p> <p>Efficiency: 93 %</p> <p>Peak intensity: 1.7 cd/lm</p> <p>LEDs/each optic: 1</p> <p>Light colour: White</p> <p>Required components:</p>	
<p><b>OSRAM</b> Opto Semiconductors</p> <p>LED: OSLOM Square CSSRM2/CSSRM3</p> <p>FWHM / FWTM: 57.0° / 89.0°</p> <p>Efficiency: 92 %</p> <p>Peak intensity: 1.1 cd/lm</p> <p>LEDs/each optic: 1</p> <p>Light colour: White</p> <p>Required components:</p>	
<p><b>OSRAM</b> Opto Semiconductors</p> <p>LED: OSLOM SSL 80</p> <p>FWHM / FWTM: 55.0° / 87.0°</p> <p>Efficiency: 91 %</p> <p>Peak intensity: 1.1 cd/lm</p> <p>LEDs/each optic: 1</p> <p>Light colour: White</p> <p>Required components:</p>	
<p><b>OSRAM</b> Opto Semiconductors</p> <p>LED: SFH 4715AS</p> <p>FWHM / FWTM: 36.0° / 75.0°</p> <p>Efficiency: 92 %</p> <p>LEDs/each optic: 1</p> <p>Light colour: White</p> <p>Required components:</p>	

#### OPTICAL RESULTS (SIMULATED):

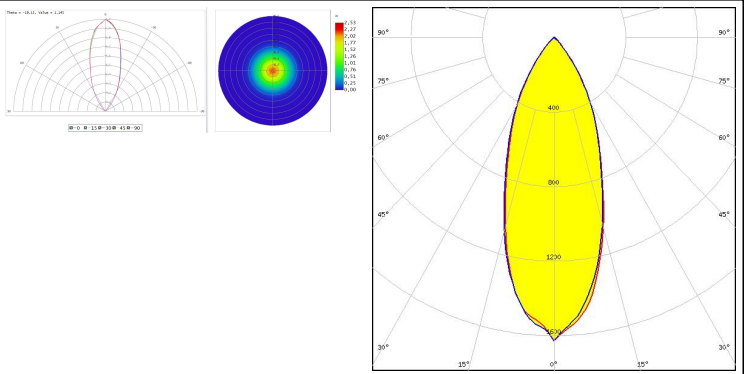
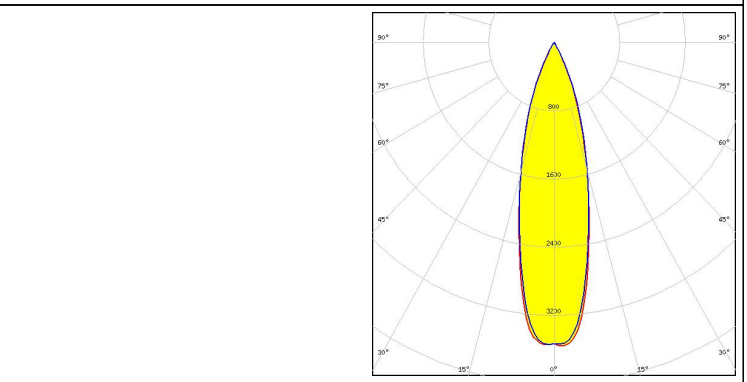
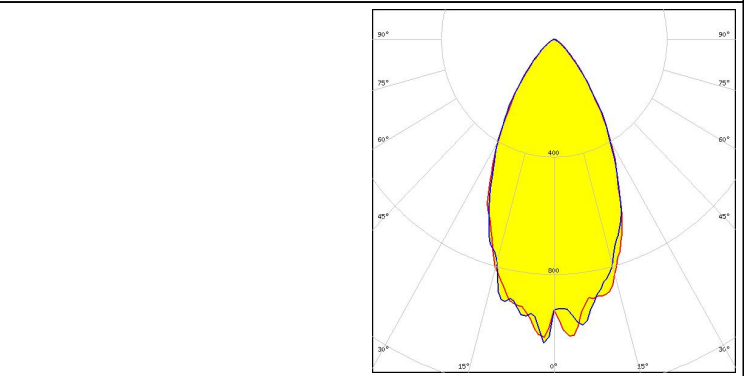
<p><b>OSRAM</b> Opto Semiconductors</p> <p>LED SFH 4725AS            FWHM / FWTM 38.0° / 76.0°            Efficiency 91 %            LEDs/each optic 1            Light colour IR            Required components:</p>	
<p><b>OSRAM</b> Opto Semiconductors</p> <p>LED SFH 4725S            FWHM / FWTM 27.0° / 52.0°            Efficiency 94 %            LEDs/each optic 1            Light colour IR            Required components:</p>	
<p><b>SEOL</b> SEOL SEMICONDUCTOR</p> <p>LED Z8Y22P            FWHM / FWTM 50.0° / 88.0°            Efficiency 86 %            Peak intensity 1.1 cd/lm            LEDs/each optic 1            Light colour White            Required components:</p>	



### GENERAL INFORMATION:

NOTE: The typical beam angle will be changed by different color, chip size and chip position tolerance. The typical total beam angle is the full angle measured where the luminous intensity is half of the peak value.

### MATERIALS:

As part of our continuous research and improvement processes, and to ensure the best possible quality and availability of our products, LEDiL reserves the right to change material grades without notice.

### PRODUCT DATA USER AGREEMENT AND DISCLAIMER:

The measured data in the provided downloadable LEDiL Product Datasheets and Mechanical 2D-Drawings is rounded and provided as reference for planning. LEDiL Oy's optical specifications have been verified by conducting performance testing of the products in accordance with the company's quality system. The reported data are averaged results of multiple measurements with typical variation. LEDiL Oy reserves the right to without prior notification make changes and improvements to its products.

LEDiL Oy assumes neither warranty, nor guarantee nor any other liability of any kind for the contents and correctness of the provided data. The provided data has been generated with highest diligence but the provided data may in reality not represent the complete possible variation range of all intrinsic parameters. Therefore, in certain cases a deviation from the provided data could occur.

LEDiL Oy reserves the right to undertake technical changes of its products without further notification which could lead to changes in the provided data. LEDiL Oy assumes no liability of any kind for the possible deviation from any provided data or any other damage resulting from the usage of the provided data.

The user agrees to this disclaimer and user agreement with the download or usage of the provided files.

#### LEDiL Oy

Joensuunkatu 13  
FI-24240 SALO  
Finland

#### LEDiL Inc.

228 West Page Street  
Suite D  
Sycamore IL 60178  
USA

#### Ledil Optics Technology (Shenzhen) Co., Ltd.

# 405 , Block B  
Casic Motor Building  
Shenzhen 518057  
P.R.CHINA

#### Local sales and technical support

[www.ledil.com/  
where\\_to\\_buy](http://www.ledil.com/where_to_buy)

#### Shipping locations

Salo, Finland  
Hong Kong, China

#### Distribution Partners

[www.ledil.com/  
where\\_to\\_buy](http://www.ledil.com/where_to_buy)