

## TRS5-110BCR01

Aliases (USEE110BCR0100)

KEMET, TRS, Thermal Reed Switch, Axial, 2.5C Temperature Accuracy, High Reliability, High-Speed Response, Long Operational Life, Excellent Environmental Durability, High Temperature Accuracy, 110°C, Break

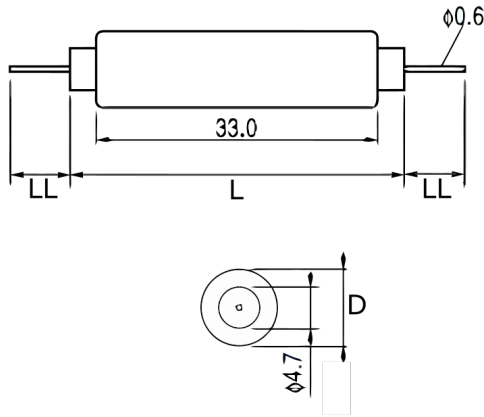

Click [here](#) for the 3D model.

### Dimensions

D	7mm NOM
L	40mm NOM
LL	8.5mm NOM

### Packaging Specifications

Packaging	Tray, Box
Packaging Quantity	600
Component Weight	3.1g

### General Information

Series	TRS
Type	Thermal Reed Switch
Style	Axial
Description	Thermal Reed Switch
Features	High Reliability, High-Speed Response, Long Operational Life, Excellent Environmental Durability, High Temperature Accuracy
Lead	Wire Leads
RoHS	Yes
REACH	Yes

### Specifications

Switching Temperature	110C +/-2.5C
Temperature Range	-20/+130°C
Contact Type	Break
Voltage DC	200 VDC MAX (Opening/Closing), 1500 VAC/1 minute or 1800 VAC/1 second
Voltage AC	140 VAC MAX (Opening/Closing)
Current	0.55 Amps AC/DC MAX (Opening/Closing), 1 mAmps MIN (5VDC, Opening/Closing)
Resistance	150 mOhms MAX (Contact Resistance)
Max Opening/Closing Power	60.5 W (AC/DC); 10 W (DC)
Max Opening/Closing Voltage	140 V (AC); 200 V (DC)
Differential Temperature	10C Maximum