

## General Description

The epc660 is a fully integrated 3D-TOF imager with a resolution of 320 x 240 pixels (QVGA). As a system on chip, the epc660 contains next to the CCD pixel-field the complete control logic to operate the device. The output of the chip is 12 bit DCS distance data per pixel, which are accessible through a high-speed digital 12-bit parallel video interface.

Only few additional components are needed to generate a complete 3D camera. Depending on illumination power and optical design, a resolution in the millimeter range for distances up to dozens of meters is feasible. Up to 158 full frame TOF images are delivered in rolling mode. The extremely high sensitivity of the chip allows for a reduced illumination power and reduced overall power consumption compared to other TOF imagers.

epc660 is based on the same technology and instruction set as the epc635 Half-QQVGA TOF imager from ESPROS.

An evaluation kit for the epc660 is available with hard- and software examples and a comprehensive manual to speed up system integration.

## Applications

- People detection and counting
- Postal parcel size measurement
- Machine safety
- Helicopter near terrain flight assistance
- ADAS systems
- Pedestrian detection and breaking systems
- Man-Machine interface
- Gesture control
- Body size measurement
- General volumetric mapping
- Mobile robotics
- Simultaneous localization and mapping (SLAM)

## Block Diagram

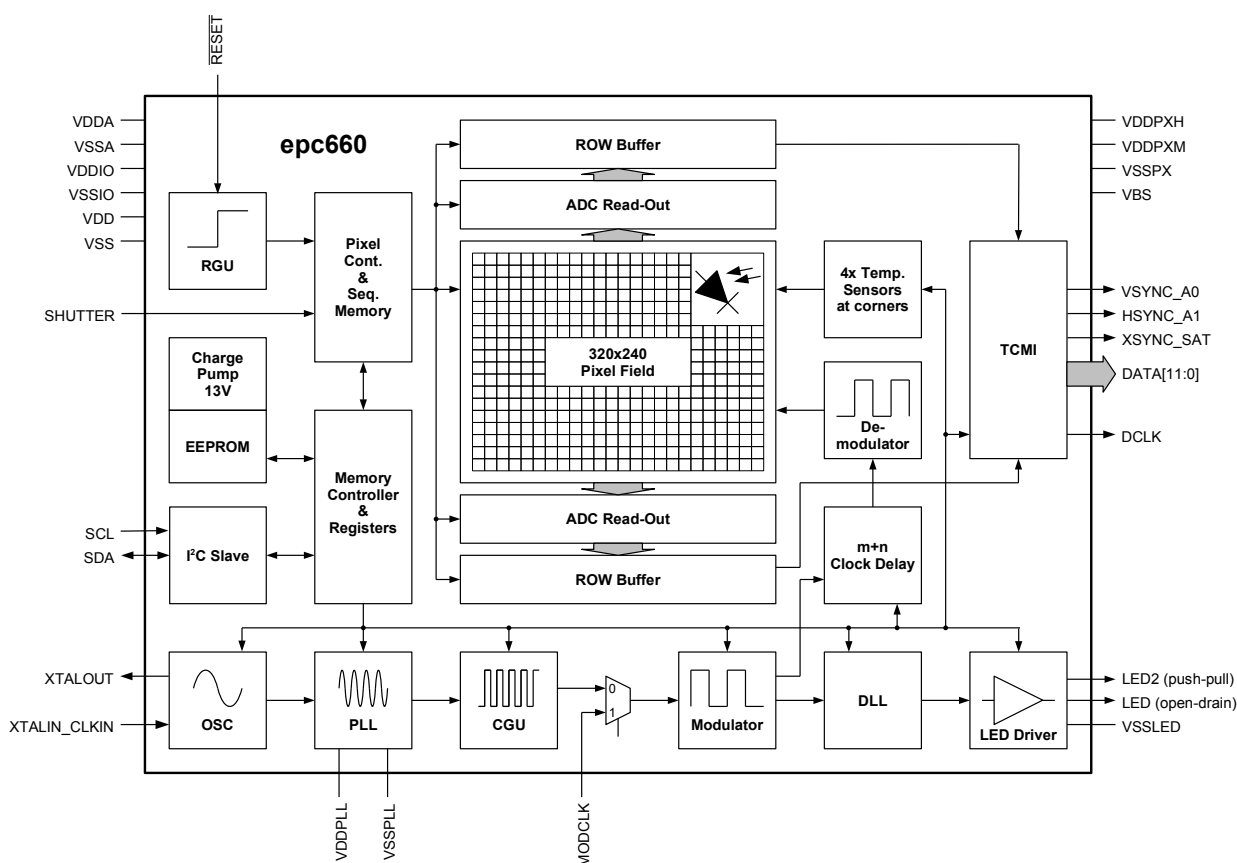

Figure 1: Functional block diagram

## Main Features

### ■ General

- 3D TOF imager in full monolithic design
- 320 x 240 pixel-field, backside illuminated
- QE >80% @ 850nm
- Full well capacity 8'000 ke- (ambient and signal)
- 39 fps full 3D TOF frame rate, single frame rate up to 158fps
- Region of interest setting allows up to several kfps
- 4 integrated temperature sensors

### ■ Measurement performance

- Absolute accuracy in the sub-centimeter range with appropriate setup and calibration

### ■ Integrated LED (or laser diode) driver

- Laser diode (LD) illumination possible
- Open-drain LED output pad, up to 200mA drive
- Push-pull LED2 output pad, up to 50mA drive

### ■ Parallel digital data interface TCM1

- 48MS/s max. data rate, 2.5/3.3V compatible
- 12/8-bit parallel DATA output + XSYNC/SAT flag
- VSYNC, HSYNC and DCLK outputs

### ■ I<sup>2</sup>C control interface (slave)

- 400kHz (FM) / 1MHz (FM+)

### ■ Integrated EEPROM 128 x 8-bit

- Calibration data and user programmable parameters
- Unique chip ID

### ■ System / modulation clock

- System clock 4MHz, internal by using crystal/resonator or using external input
- External LED/LD modulation input MODCLK (optional) up to 96MHz

### ■ Power supply

- Supply voltages +10V, +5V, +2.5/3.3V, +1.8V, -10V
- Power consumption approx. 750mW (average)

### ■ Packaging

- 9.7x8.7mm cost optimized 68pin CSP (chip scale package),
- Backside illuminated flip-chip SMD mounting

### ■ Other data

- ROHS compatible

## Measurement Modes

### ■ Illumination modulation modes

- Sinusoidal modulation
- Selectable modulation frequencies 0.75 ... 24MHz resulting in unambiguity distance of 6.25m ... 200m

### ■ Distance measurement modes

- 39 fps 3D TOF with 4x DCS frames, full pixel-field
- 79 fps 3D TOF with 2x DCS frames, full pixel-field
- 158 fps 3D TOF with rolling read-out 4x DCS frames, full pixel-field
- Ultra fast measurement by reduction of the image field (ROI)
- SHUTTER release input for precise start/stop and single/continuous measurement control

### ■ Non distance measurement modes

- Ambient-light measurement (Grayscale image without illumination)
- Grayscale image with active illumination

## Readout Modes

### ■ ROI (Region of interest)

- Rectangular sub-pixel-field read-out
- Increased frame rate

### ■ Binning and resolution reduction

- Binning of max. 4 adjacent pixels (2 hor. and 2 ver.)
- Resolution reduction to 2<sup>nd</sup>, 4<sup>th</sup> or 8<sup>th</sup> row or column to read-out
- Increased frame rate for reduced number of rows

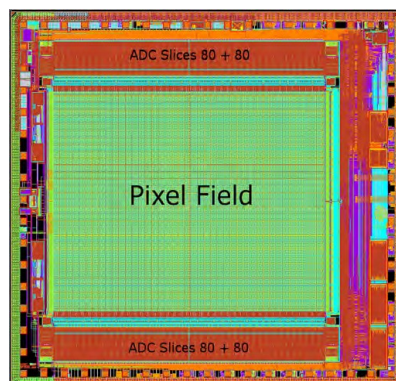

Figure 2: Picture of the epc660

# Table of Contents

<b>1. Electrical, optical and timing characteristics</b>	<b>5</b>
1.1. Operating conditions and electrical characteristics	5
1.2. Absolute maximum ratings	6
1.3. Timing parameters	6
1.4. Optical characteristics	6
1.5. Sensitivity	7
1.6. Ambient-light suppression (ABS)	7
1.7. Other optical parameters	8
1.8. Temperature sensor characteristics	8
1.9. Distance measurement temperature drift	8
<b>2. Pin-out</b>	<b>9</b>
2.1. Pin mapping	9
2.2. Pin list	9
2.3. Power domain separation and ESD protection	12
<b>3. Packaging and layout information</b>	<b>12</b>
3.1. Mechanical dimensions	12
3.2. Parasitic light sensitivity (PLS)	13
3.3. Pin1 marking	14
3.4. Location of the photosensitive area	14
3.5. PCB design and SMD manufacturing process considerations	14
3.6. Packaging information	15
<b>4. Ordering information</b>	<b>16</b>
4.1. Notes to various chip releases	16
<b>5. Hardware implementation</b>	<b>17</b>
5.1. Typical application diagram	17
5.2. Application diagram part list	18
5.3. Hardware implementation notes	18
5.4. Clock source	20
5.5. External modulation MODCLK	20
5.6. Supply, reset and start-up options	21
5.6.1. Supply voltages and external reset	21
5.6.2. Start-up (Clock, PLL turn-on and EEPROM copy)	22
5.6.3. Strap pins	22
5.7. LED driver	23
5.8. DLL (Delay Line)	23
5.9. Application system overview	24
<b>6. TOF camera interface (TCMI)</b>	<b>25</b>
6.1. TCMI clock	25
6.2. Single or continuous measurement control	25
6.2.1. Single measurement control	25
6.2.2. Continuous measurement control (auto-run)	25
6.3. TCMI timing	26
6.4. TCMI data format	27
6.5. Frame rate and data-out performance	29
6.5.1. Frame rate QVGA 320x240 pixel (default)	29
6.5.2. Frame rate Half QQVGA 160x60 pixel	30
6.5.3. Memory space estimation QVGA	30
<b>7. Pixel architecture</b>	<b>31</b>
<b>8. Pixel-field and operation modes</b>	<b>31</b>
8.1. Pixel coordinates	31
8.2. Operation modes	32
8.2.1. Full resolution mode (default)	32
8.2.2. Dual phase mode (motion blur reduction)	32
8.2.3. Dual integration time mode (high dynamic range, HDR mode)	33
8.2.4. Pixel binning	34
8.2.5. Resolution reduction	34
8.2.6. Region of interest (ROI)	36
8.3. Pixel saturation detection	37
8.3.1. Hardware saturation flag	37
8.3.2. Software saturation flag	37
<b>9. Imaging</b>	<b>37</b>
9.1. Distance measurement (3D TOF)	37
9.2. Distance calculation algorithm	38

9.2.1. Unambiguity range versus time base setting .....	38
9.2.2. Quality of the measurement result .....	39
9.3. Grayscale imaging .....	40
9.4. Calibration and compensation of TOF cameras .....	40
9.5. Noise reduction and signal filtering .....	40
<b>10. Temperature sensors .....</b>	<b>41</b>
10.1. Initialization .....	41
10.2. Readout during runtime .....	41
10.3. Calculate temperature in °C .....	42
<b>11. Application information .....</b>	<b>43</b>
11.1. Start-up and initialization sequence .....	43
11.2. Image acquisition .....	43
11.3. 3D TOF distance measurement flow .....	43
11.4. Integration time setting .....	46
11.5. Special mode setting .....	46
11.5.1. Dual phase mode selection (motion blur reduction) .....	46
11.5.2. Dual integration time mode selection (high dynamic range) .....	46
11.5.3. epc635 emulation .....	46
11.6. Power consumption .....	48
11.7. Rolling DCS frames .....	49
11.8. Enhanced rolling DCS frame mode .....	49
<b>12. Parameter and configuration memory .....</b>	<b>50</b>
12.1. Data memory map .....	50
12.1.1. Control page .....	51
12.1.2. RAM page .....	51
12.1.3. EEPROM page .....	51
<b>13. I<sup>2</sup>C interface .....</b>	<b>51</b>
13.1. Device addressing .....	51
13.2. I <sup>2</sup> C bus protocol notation .....	51
13.3. I <sup>2</sup> C bus timing .....	52
13.4. I <sup>2</sup> C commands .....	52
13.4.1. Software reset .....	52
13.4.2. Device address reload .....	52
13.4.3. Write single-byte .....	53
13.4.4. Write multi-byte .....	53
13.4.5. Read single-byte .....	53
13.4.6. Read multi-byte .....	53
13.5. Command timing .....	54
<b>14. Register map .....</b>	<b>54</b>
14.1. Control page 0x00 ~ 0x7F .....	55
14.2. RAM page (0x80 ~ 0xEF) .....	56
14.3. EEPROM page, indirect data access section (0xF0 ~ 0xFF) .....	60
<b>15. Control command examples .....</b>	<b>61</b>
15.1. I <sup>2</sup> C control command examples: .....	61
15.2. Software reset with I <sup>2</sup> C general call command .....	61
15.3. 4 DCS: Acquire DCS0 ... 3 frames with $t_{int} = 16.6\mu s$ @ 12MHz modulation frequency .....	61
15.4. 4 DCS: Acquire DCS0 ... 3 frames with $t_{int} = 16.6\mu s$ , followed by DCS 0 ... 3 with $t_{int} 333\mu s$ @ 12MHz mod. frequency .....	61
15.5. 2 DCS: Acquire DCS0 and 1 with $t_{int} = 16.6\mu s$ @ 12MHz modulation frequency .....	61
15.6. Indirect single write to EEPROM: Store 1 byte at user register 0xF0 .....	61
15.7. Indirect single read from EEPROM: Read 1 byte from user register 0xF0 .....	61
15.8. Reading part version (register 0xFB) .....	62
15.9. Reading IC version (register 0x01) .....	62
15.10. Reading WAFER ID and CHIP ID .....	62
15.11. Pixel sequencer code write procedure .....	62
15.12. Pixel sequencer code .....	62
15.13. Pixel sequencer code readback .....	64
15.14. Accuracy improvement .....	65
<b>16. Addendum .....</b>	<b>66</b>
16.1. Terms, definitions and abbreviations .....	66
16.2. Related documents .....	66
<b>17. IMPORTANT NOTICE .....</b>	<b>67</b>

# 1. Electrical, optical and timing characteristics

All characteristics are at typical operational ratings,  $T_A = +25^\circ\text{C}$ , modulation frequency 12MHz, supply voltages at nominal value, unless otherwise stated

## 1.1. Operating conditions and electrical characteristics

Parameter	Description	Conditions/Comments	Min.	Typ.	Max.	Units
$V_{DD}, V_{DDPLL}$	Digital supply voltage	Ripple <sup>1</sup> < $\pm 20$ mV	1.71	1.80	1.98	V
$V_{DDIO}$	IO supply voltage <sup>3</sup>	Ripple <sup>1</sup> < $\pm 50$ mV	2.25	2.5/3.3	3.63	V
$V_{DDA}, V_{DDPXM}$	Analog 1 supply voltage <sup>2</sup>	Ripple <sup>1</sup> < $\pm 20$ mV	4.9	5.0	5.1	V
$V_{DDPXH}$	Analog 2 supply voltage <sup>2</sup>	Ripple <sup>1</sup> < $\pm 20$ mV	9.5	10	10.5	V
$V_{BS}$	Bias supply voltage	Ripple <sup>1</sup> < $\pm 50$ mV	-10.5	-10.0	-9.75	V
$I_{VDD}$	Total digital supply current, including PLL supply current			14	20	mA
$I_{VDDPLL}$	PLL supply current			4		mA
$I_{VDDIO}$	IO supply current <sup>4</sup>			8		mA
$I_{VDDA}$	Analog supply current			125	350	mA
$I_{VDDPXM}$	Analog 1 supply current			1		mA
$I_{VDDPXH}$	Analog 2 supply current			13		mA
$I_{VBS}$	Bias supply current <sup>8</sup>			3.8 <sup>8</sup>		mA
$V_{LED\_ON}$	LED on-voltage forward voltage	@ $I_{LEDOD-ON} = 100$ mA @ $I_{LEDOD-ON} = 200$ mA		0.1 0.2		V V
$I_{LED\_LEAK}$	LED leakage current	@ LEDOD off-voltage			10	$\mu\text{A}$
$I_{LED2\_SINK}$	LED2 output sink/source current				50	mA
$V_{IH\_VDDIO}$	Digital high level input voltage <sup>5</sup>	excluding XTALIN	$0.7 \times V_{DDIO}$			V
$V_{IL\_VDDIO}$	Digital low level input voltage <sup>5</sup>	excluding XTALIN			$0.3 \times V_{DDIO}$	V
$V_{IH\_XTALIN}$	Digital high level input voltage	XTALIN	1.35			V
$V_{IL\_XTALIN}$	Digital low level input voltage	XTALIN			0.2	V
$V_{OH}$	Digital high level output voltage <sup>5,6</sup>		$0.8 \times V_{DDIO}$			V
$V_{OL}$	Digital low level output voltage <sup>5,6</sup>				$0.2 \times V_{DDIO}$	V
$R_{PD}$	Pull-down resistor in RESET, VSYNC_A0, HSYNC_A1			600		k $\Omega$
$I_{IH}$	Digital high level input current <sup>7</sup>	$V_{IH}$ max.			$10^{-7}$	$\mu\text{A}$
$I_{IL}$	Digital low level input current <sup>7</sup>	$V_{IL}$ min.	$-10^{-7}$			$\mu\text{A}$
$I_{OH}$	Digital output source current <sup>7</sup>	$V_{OH}$ max.			50	mA
$I_{OL}$	Digital output sink current <sup>3</sup>	$V_{OL}$ min.	-50			mA
$C_{IO}$	IO load capacitance <sup>5</sup>				30	pF
$f_{IO}$	IO switching frequency <sup>5</sup>			24	48	MHz
$P_{PK}$	Power dissipation (average)	See 28		750		mW
$R_{Th}$	Thermal resistance	on PCB with underfill			40	$^\circ\text{K/W}$
$T_{OP}$	Operating temperature		-40		105	$^\circ\text{C}$

Table 1: Operating conditions and electrical characteristics

### Notes:

- <sup>1</sup> Min. and Max. voltage values include noise and ripple voltages.
- <sup>2</sup> Analog voltage supplies have direct influence on measurement performance. They must be properly decoupled for low noise and ripple.
- <sup>3</sup> IO voltage supply must be equal to external processor's IO supply voltage levels used in the application. It can be set to any value within min and max. operating voltage.
- <sup>4</sup> When device is operated at max  $f_{DCS}$  frame rate, DCLK at 48MHz, driving loads 15pF each.
- <sup>5</sup> I<sup>2</sup>C pins SCL and SDA are open-drain outputs and need termination (pull-up resistor) according to I<sup>2</sup>C standards.
- <sup>6</sup>  $V_{OH/OL}$  and  $I_{OH/OL}$  values are measured at max  $C_{IO}$  and max  $f_{IO}$ .
- <sup>7</sup> Value is without termination resistors
- <sup>8</sup> A bright illuminated white target right in front of the chip with lens leads to an  $I_{VBS}$  of approx. 3.8 mA, without any illumination approx. 3.6 mA and with strong illumination (approx. 55 mW/cm<sup>2</sup>, no lens) typ. 17 mA.

## 1.2. Absolute maximum ratings

Parameter	Conditions
Supply voltage $V_{DD}$ , $V_{DDPLL}$	-0.5V ... +2.0V
Supply voltage $V_{DDIO}$ , $V_{DDA}$ , $V_{DDPXM}$	-0.5V ... +5.5V
Supply voltage $V_{DDPXH}$	-0.5V ... +13.5V
Supply voltage $V_{BS}$	-12.0 ... +0.5V
Voltage to any pin in the same $V_{SC}$ supply class.	$V_{SC\ min} - 0.3V \dots V_{SC\ max} + 0.3V$
LED sink current $I_{ON\_LED}$ (modulated peak current, refer to 17)	200 mA @ $T_J$ 85°C 25 mA @ $T_J$ 125°C linear reduction between 85 and 125°C
LED off-voltage $V_{OFF\_LED}$ (open-drain output)	7.5 V
ESD rating	JEDEC HBM class 1C (1kV to < 2kV)
Junction temperature ( $T_J$ )	-40°C to +125°C
Relative humidity	0 ... 95%, non-condensing

Table 2: Absolute maximum ratings

## 1.3. Timing parameters

Parameter	Description	Conditions	Min.	Typ.	Max.	Units
$t_{STARTUP}$	Start-up time	after applying external supplies		340	1'000	µs
$t_{RESET}$	RESET		100			ns
$t_{PLLStrap\_scan}$	Scanning strap pins		4x osc_clk			
$t_{PLL}$	PLL lock time				30	µs
$t_{DLL}$	DLL delay for 1 step	approx. 30cm distance shift per step. Refer for details to register 0x73 and 22, for exact value to register 0xE9.		2.1		ns
$t_{DRV}$	Illumination driver delay	delay of LED/LED2 versus demodulation, refer to 63		8.4		ns
$t_{EEPROM\_to\_CFG}$	Load CFG registers	copy EEPROM to CFG registers		340		µs
$t_{EEPROM\_Write}$	Write EEPROM	waiting time per byte			25	ms
$f_{XTAL}$	Clock frequency	determines the distance measurement accuracy	3.8	4	4.2	MHz
$df_{XTAL}$	Clock frequency deviation	any deviation is added as a linear distance error			±100	ppm
$f_{JITTER}$	Clock frequency phase jitter	peak-to-peak, cycle to cycle			50	ps
$f_{LED}$	LED modulation frequency		0.75		24	MHz
$f_{MODCLK}$	Ext. modulation clock	refer to chapter 5.5			96	MHz
$t_{LED\_rise/fall}$	Rise/fall time LED/LD				12	ns
$f_{DCLK}$	TCMI pixel rate	12 bit pixel data + saturation flag		24	48	MHz
$f_{TCMI\_data}$	TCMI data rate			312	624	Mbit/s
$f_{SCL}$	I <sup>2</sup> C data rate				1	Mbit/s

Table 3: Timing parameters

## 1.4. Optical characteristics

Parameter	Description	Conditions/Comments	Value	Units
$A_{PIXEL}$	Pixel photosensitive area	100% fill factor	20 x 20	µm
$A_{SENSOR}$	Pixel-field area	320 x 240 pixel	6.4 x 4.8	mm

Table 4: Optical characteristics

### 1.5. Sensitivity

@ integration time 100  $\mu$ s

Parameter	Description	Min.	Typ.	Max.	Units
TOF sensitivity $S_{TOF}$	<ul style="list-style-type: none"> <li>Modulation frequency 12MHz</li> <li>Amplitude 1,400 LSB</li> </ul>	640nm	0.75	0.9	1.05
		850nm	0.50	0.6	0.70
		940nm	0.65	0.8	0.95
TOF <sub>SENS</sub> FPN	Sensitivity fix pattern noise, @ 1,400 LSB		40	100	LSB
TOF <sub>DIST</sub> FPN	Distance fix pattern noise, @ 1,400 LSB		18	50	mm
$I_{Dark}$	Dark current (drift during readout)		10	20	LSB/ms
Grayscale sensitivity	Normal operation	0.19	0.25	0.31	$\frac{nW/mm^2}{LSB}$
	Temperature sensing mode	0.48	0.62	0.76	$\frac{nW/mm^2}{LSB}$
$H_v$	Optical sensitivity		150k		$\frac{LSB}{Lux/sec}$
GS <sub>STD</sub>	Grayscale standard deviation		25	100	LSB

Table 5: Sensitivity

### 1.6. Ambient-light suppression (ABS)

An important function of the 3D TOF pixel is the ambient-light suppression. It removes DC or low frequency modulated light caused by sunlight, room illumination, etc. from the modulated light generated by the camera illumination. The amount of collected ambient light is proportional to the integration time. The longer the integration time, the more unwanted light will be collected. It's a good practice to keep the integration time for TOF imaging below 1ms. In addition, optical bandpass filters to block the unwanted light spectrum is mandatory.

Parameter	Ambient light suppression	Integration time	Wave-length	Min.	Typ.	Max.	Units
$E_e$	Irradiance, DC light	100 $\mu$ s	640nm	0.30			$mW/mm^2$
			850nm	0.20			
			940nm	0.25			

Parameter	Ambient light suppression	Integration time	Center wavelength	Bandwidth	Min.	Typ.	Max.	Units
$E_v$	Luminance equivalent, sunlight	500 $\mu$ s	640nm	$\pm 27.5$ nm	85			kLux
			850nm	$\pm 32.5$ nm	70			
			940nm	$\pm 30$ nm	190			

Table 6: Ambient light suppression

Note:

The default and suggested chip configuration is set to achieve highest possible frame rate and using additional ambient-light correction according the Application note AN10 Calibration and compensation: Register 0x90, bit 3 = 0 and 0xAB = 0x00. A 20% more efficient ambient-light suppression is possible, if the the following registers are modified:

0x90, bit 3 = 1

0xAB = 0x01

It turns the LED modulation before each integration for additional 33 $\mu$ s @ 24MHz modulation frequency on. This modulation is independent of the effective integration time. The on-time depends on the modulation frequency by  $t_{ON} = 40\mu s * 20MHz / \text{modulation frequency}$ .

### 1.7. Other optical parameters

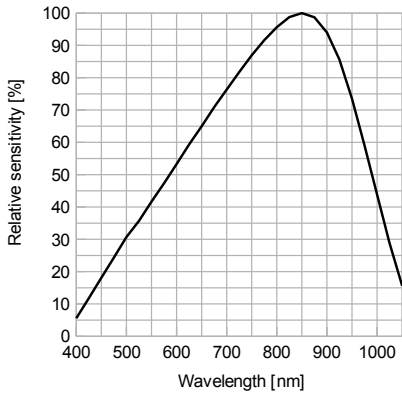

Figure 3: Relative spectral sensitivity ( $S_r$ ) vs. wavelength

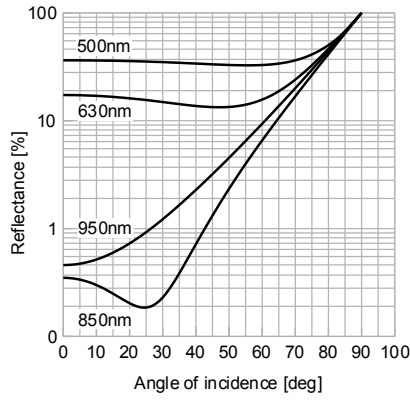

Figure 4: Reflectance vs. illumination angle (AOI)

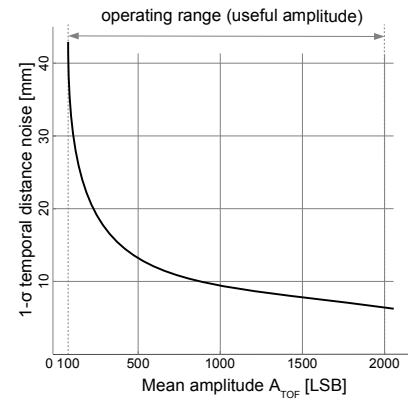

Figure 5: Typ. distance noise, single shot, 4 DCS, no ambient-light, see chapter 9.2.2

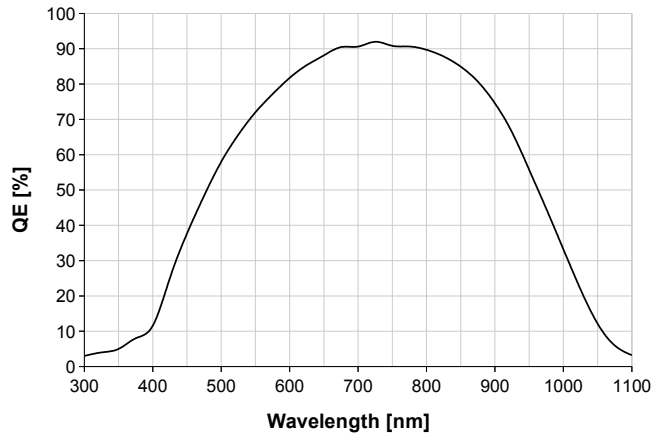

Figure 6: Typical quantum efficiency

### 1.8. Temperature sensor characteristics

Parameter	Description	Conditions	Min.	Typ.	Max.	Units
$T_{TEMP}$	Measurement range		-40		+105	°C
$P_{TEMP}$	Sensor resolution			14		bit
k	Temperature sensor gain			0.067		K/LSB
Lin	Linearity	Over temperature range		5		%
$T_{CAL}$	Calibration temperature		26.5	27.0	27.5	°C

Table 7: Temperature sensor characteristics

Note: Refer also to chapter 10.

### 1.9. Distance measurement temperature drift

@12MHz modulation frequency

Parameter	Description	Min.	Typ.	Max.	Units
$TC_{PIX}$	Pixel		11.3		mm/K
$TC_{OD}$	LED/LD driver		2.7		mm/K
$TC_{DLLn}$	DLL stage, per stage		0.65		mm/K

Table 8: Optical characteristics

Note: Values vary from imager to imager. Refer for details to 21 and application note AN10 Calibration and Compensation, chapter temperature compensation.



## 2. Pin-out

### 2.1. Pin mapping

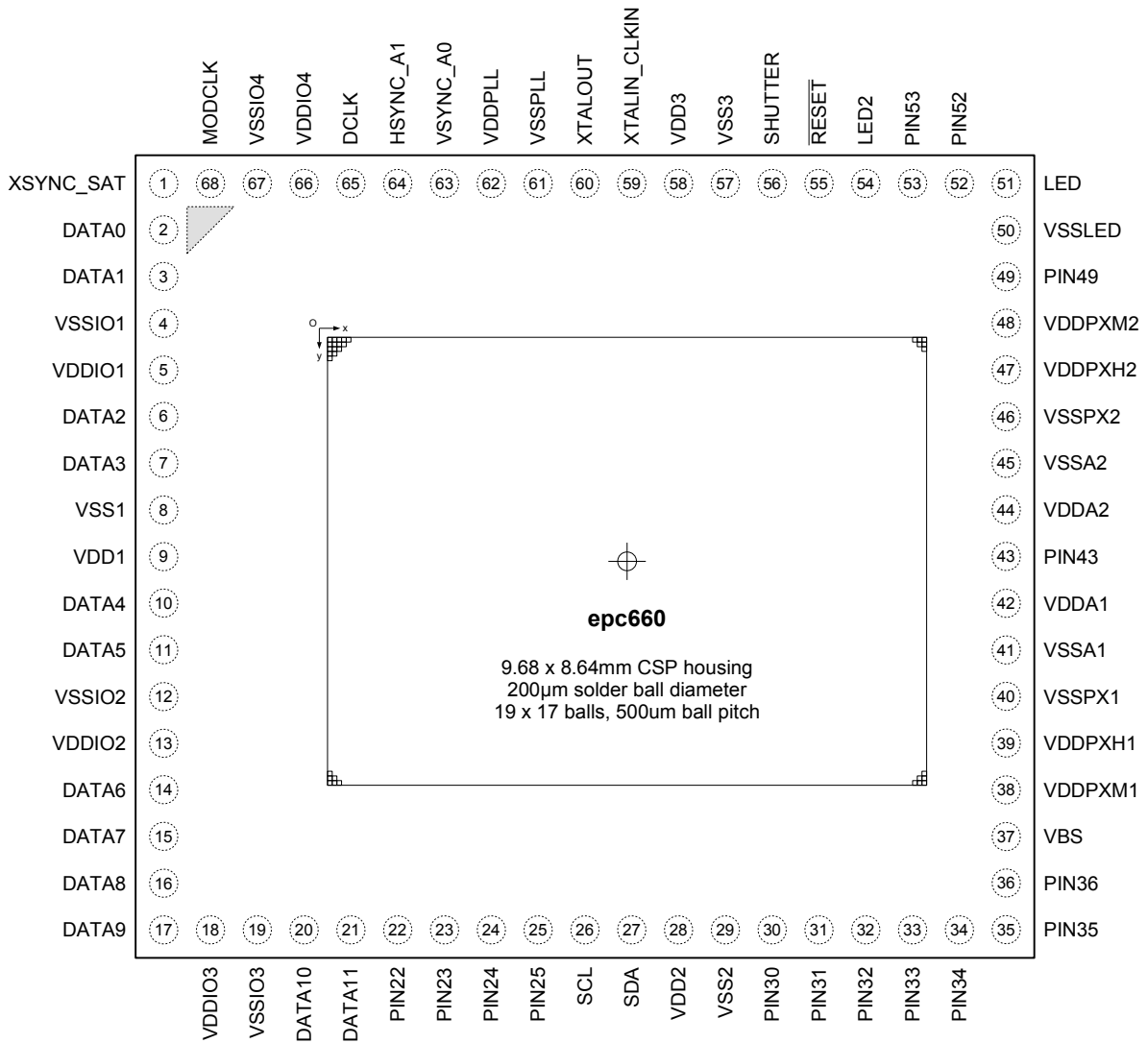

Figure 7: CSP pin mapping (top-view, solder balls are at the bottom, pixel-field is at the top)

### 2.2. Pin list

Pin No.	Pin name	Supply class $V_{sc}$	Pin type	RESET function	RESET level	Description
<b>IO pins</b>						
2	DATA0	$V_{DDIO}$	DIO	IPD	$V_{OL}$	TCMI high-speed output bit 0, no pull-up resistor allowed.
3	DATA1	$V_{DDIO}$	DIO	IPD	$V_{OL}$	TCMI high-speed output bit 1
6	DATA2	$V_{DDIO}$	DIO	IPD	$V_{OL}$	TCMI high-speed output bit 2
7	DATA3	$V_{DDIO}$	DIO	IPD	$V_{OL}$	TCMI high-speed output bit 3
10	DATA4	$V_{DDIO}$	DIO	IPD	$V_{OL}$	TCMI high-speed output bit 4
11	DATA5	$V_{DDIO}$	DIO	IPD	$V_{OL}$	TCMI high-speed output bit 5
14	DATA6	$V_{DDIO}$	DIO	IPD	$V_{OL}$	TCMI high-speed output bit 6
15	DATA7	$V_{DDIO}$	DIO	IPD	$V_{OL}$	TCMI high-speed output bit 7

Table 9: Pin list

Pin No.	Pin name	Supply class V <sub>sc</sub>	Pin type	RESET function	RESET level	Description
16	DATA8	V <sub>DDIO</sub>	DIO	IPD	V <sub>OL</sub>	TCMI high-speed output bit 8
17	DATA9	V <sub>DDIO</sub>	DIO	IPD	V <sub>OL</sub>	TCMI high-speed output bit 9
20	DATA10	V <sub>DDIO</sub>	DIO	IPD	V <sub>OL</sub>	TCMI high-speed output bit 10
21	DATA11	V <sub>DDIO</sub>	DIO	IPD	V <sub>OL</sub>	TCMI high-speed output bit 11
65	DCLK	V <sub>DDIO</sub>	DIO	IPD	V <sub>OL</sub>	TCMI data clock output
63	VSYNC_A0	V <sub>DDIO</sub>	DIO	IPD	V <sub>OH</sub>	TCMI VSYNC output / strap input 0, refer to chapter 5.6.3
64	HSYNC_A1	V <sub>DDIO</sub>	DIO	IPD	V <sub>OH</sub>	TCMI HSYNC output / strap input 1, refer to chapter 5.6.3
1	XSYNC_SAT	V <sub>DDIO</sub>	DIO	IPD	V <sub>OH</sub>	TCMI XSYNC / TCMI saturation flag output, no pull-up resistor allowed.
26	SCL	V <sub>DDIO</sub>	DIOD	I	V <sub>IH</sub>	I <sup>2</sup> C clock input <sup>4</sup>
27	SDA	V <sub>DDIO</sub>	DIOD	I	V <sub>IH</sub>	I <sup>2</sup> C data input/output <sup>4</sup>
56	SHUTTER	V <sub>DDIO</sub>	DI	PD	V <sub>IL</sub>	Shutter input <sup>5</sup>
55	RESET	V <sub>DDIO</sub>	DI	PD	V <sub>IL</sub>	Reset input (active low), 600kΩ int. pull-down <sup>3</sup>
68	MODCLK	V <sub>DDIO</sub>	DI	PD		Modulator/demodulator external clock input.
54	LED2	V <sub>DDIO</sub>	DO			LED driver push-pull output <sup>2</sup>
22	PIN22	---	DO		V <sub>OL</sub>	Do not any electrical connection except to a test pad (suggested).
23	PIN23	---	DI	PU	V <sub>IH</sub>	
24	PIN24	---	DI	PD	V <sub>IL</sub>	
25	PIN25	---	DI	PU	V <sub>IH</sub>	
<b>Digital pins</b>						
59	XTALIN_CLKIN	V <sub>DDPLL</sub>	AI			XTAL or Resonator in / CLKIN from external clock source
60	XTALOUT	V <sub>DDPLL</sub>	AO			XTAL or Resonator out
<b>Analog pins</b>						
51	LED	V <sub>DDLED</sub>	AOD		V <sub>LED max</sub>	LED/LD driver open-drain output <sup>2</sup>
35	PIN35	V <sub>DDPXH</sub>	---			Connect to VSSPX with 10 kOhm
36	PIN36	V <sub>DDPXH</sub>	AI			
31	PIN31	---	AI			Do not any electrical connection except to a test pad (suggested).
32	PIN32	---	AI			
33	PIN33	---	---			
34	PIN34	---	---			
49	PIN49	---	AI			
52	PIN52	---	---			
53	PIN53	---	---			
<b>Supply pins, digital</b>						
5	VDDIO1	V <sub>DDIO</sub>	PWR			IO supply VDDIO
13	VDDIO2	V <sub>DDIO</sub>	PWR			
18	VDDIO3	V <sub>DDIO</sub>	PWR			
66	VDDIO4	V <sub>DDIO</sub>	PWR			
9	VDD1	V <sub>DD</sub>	PWR			Digital supply VDD
28	VDD2	V <sub>DD</sub>	PWR			
58	VDD3	V <sub>DD</sub>	PWR			
62	VDDPLL	V <sub>DDPLL</sub>	PWR			PLL supply
4	VSSIO1	V <sub>DDIO</sub>	GND			IO ground VSSIO
12	VSSIO2	V <sub>DDIO</sub>	GND			
19	VSSIO3	V <sub>DDIO</sub>	GND			
67	VSSIO4	V <sub>DDIO</sub>	GND			

9 cont.: Pin list

Pin No.	Pin name	Supply class $V_{sc}$	Pin type	RESET function	RESET level	Description
8	VSS1	$V_{DD}$	GND			Digital ground VSS
29	VSS2	$V_{DD}$	GND			
57	VSS3	$V_{DD}$	GND			
61	VSSPLL	$V_{DDPLL}$	GND			PLL ground
<b>Supply pins, analog</b>						
42	VDDA1	$V_{DDA}$	PWR			Analog supply VDDA
44	VDDA2	$V_{DDA}$	PWR			
37	VBS	$V_{BS}$	PWR			Bias supply
39	VDDPXH1	$V_{DDPXH}$	PWR			Pixel analog 2 supply VDDPXH
47	VDDPXH2	$V_{DDPXH}$	PWR			
38	VDDPXM1	$V_{DDPXM}$	PWR			Pixel analog 1 supply VDDPXM
48	VDDPXM2	$V_{DDPXM}$	PWR			
41	VSSA1	$V_{DDA}$	GND			Analog ground VSSA
45	VSSA2	$V_{DDA}$	GND			
40	VSSPX1	$V_{DDPX}$	GND			Pixel analog ground VSSPX
46	VSSPX2	$V_{DDPX}$	GND			
50	VSSLED	$V_{DDLED}$	GND			LED/LD driver ground (return current) <sup>1</sup>
30	PIN30	$V_{PIN35}$	PWR			Connect to VSS
43	PIN43	$V_{PIN43}$	PWR			Connect to VDDA

9 cont.: Pin list

Notes:

- <sup>1</sup> VSSLED is the dedicated, isolated GND pin for the LED/LD return-current from external circuitry. It must be connected to PCB GND plane together with the other VSSA GND pins.
- <sup>2</sup> LED output can be used to drive an external amplifier with an addition of a pull-up resistor. The voltage at LED output pin must not exceed value in Table 1: Operating conditions and electrical characteristics.  
LED2 output is a push-pull driver for delivering symmetric rise/fall times to the external LED driver circuit. LED2 is internally connected to VDDIO/VSSIO supplies. During integration time, all TCMI pins are silent except for DCLK. As a result, LED2 pin will not pick up switching noise from all other TCMI pins but the layout has to take care of the DCLK line.  
LED and LED2 must not be used simultaneously for driving LED circuits on the PCB. They exhibit different insertion delays and may cause unpredicted distance offset/measurement results.
- <sup>3</sup> RESET pin has a 600k $\Omega$  (typical) internal pull-down resistor. Therefore, this pin can be safely connected to a standard GPIO of a CPU which is initially high-Z or open-drain during power up sequence. Once the SW takes control, it can program this GPIO as output and drive 1 to release the RESET. The internal pull-down can be override by an external 10k $\Omega$  pull-up and a series capacitor to build a simple delayed power-on reset for evaluation/qualification purposes.
- <sup>4</sup> I<sup>2</sup>C pins SCL, SDA are according to I<sup>2</sup>C standards. They are I<sup>2</sup>C slave pins which need external pull-up resistors on the PCB. Values of R1 and R2 in the schematics are given only for indicative purposes and must be re-calculated according to the total capacitive load of all I<sup>2</sup>C slave/master devices and operating mode (FM or FM+) of the I<sup>2</sup>C (chapter 13) in the application.
- <sup>5</sup> If HW shutter is not used, connect this pin to GND

'Pin type' in 9 defines the following:

- DI: Digital Input
- DO: Digital Output
- DIO: Digital Input/Output (bidirectional)
- DIOD: Digital Input/Output (bidirectional), open-Drain
- AI: Analog Input
- AO: Analog Output
- AOD: Analog Output, open-Drain
- PWR: Supply
- GND: Ground

'Rst. Func.' in 9 defines the function of IO pins during reset:

- I: Input
- PU: internal Pull-Up
- PD: internal Pull-Down
- IPD: Input with internal Pull-Down

'Rst. Level' in 9 defines the level of the IO pins during/after reset (chapter 5.6)

### 2.3. Power domain separation and ESD protection

The epc660 chip has internally 10 different power domains and 6 ground references which are interconnected with ESD protection diodes. All pins are also equipped with ESD protection diodes. The diodes have a breakthrough voltage of 0.3V. The designer has to take care that none of these diodes become conductive either at power-up, power-down or normal operation.

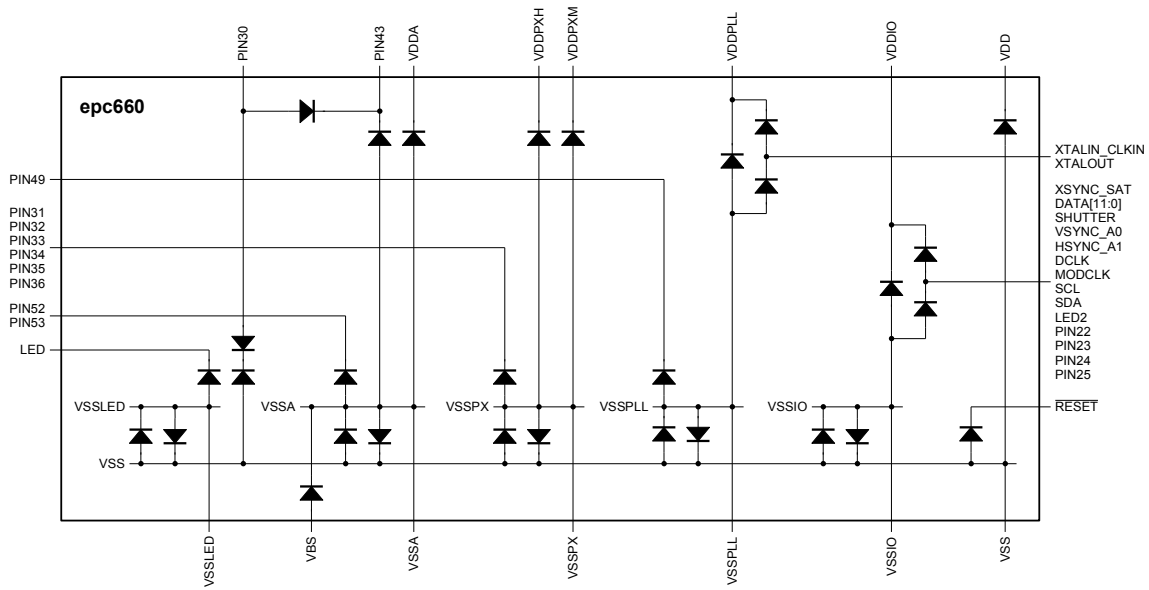

Figure 8: I/O pins and ESD protection diagram

## 3. Packaging and layout information

### 3.1. Mechanical dimensions

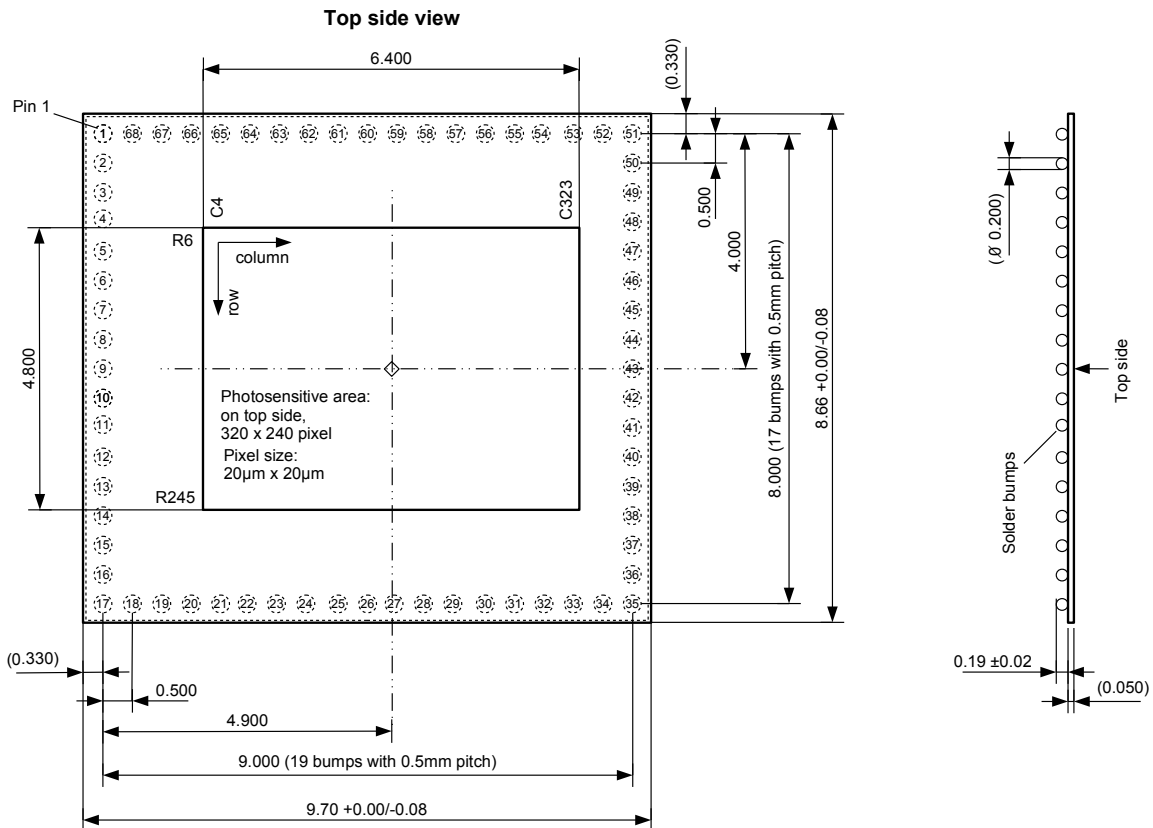

Figure 9: Mechanical dimensions

#### Notes:



■ all measures in mm

- not specified tolerances:  $\pm 0.001$ mm
- Dimensions in brackets informal only
- Top side is illumination side

### 3.2. Parasitic light sensitivity (PLS)

CMOS circuits are sensitive to light. That is why they can be used for photo-sensing, imaging, etc. However, if strong light is radiating the chip beside the pixel field, analog and digital circuits can be affected in its function by such parasitic light. It is called parasitic light sensitivity (PLS). A known effect is a shift of the measured distance under strong ambient light. Imager lenses have always a larger field of view than the pixel-field area. In order to prevent the chip being illuminated by strong ambient light, an opaque aperture should be placed onto the photosensitive side of the imager as shown in 10. The cover shall have an opening of 6.690 x 5.090 mm. With regard to the 6.400 x 4.800 mm pixel-field size, this shield can be assembled with a tolerance of  $\pm 120 \mu\text{m}$  in x and y axis. Such a cover can be made by a thin sheet metal stencil like an SMD solder paste printing stencil or by silk screen printing of black color.

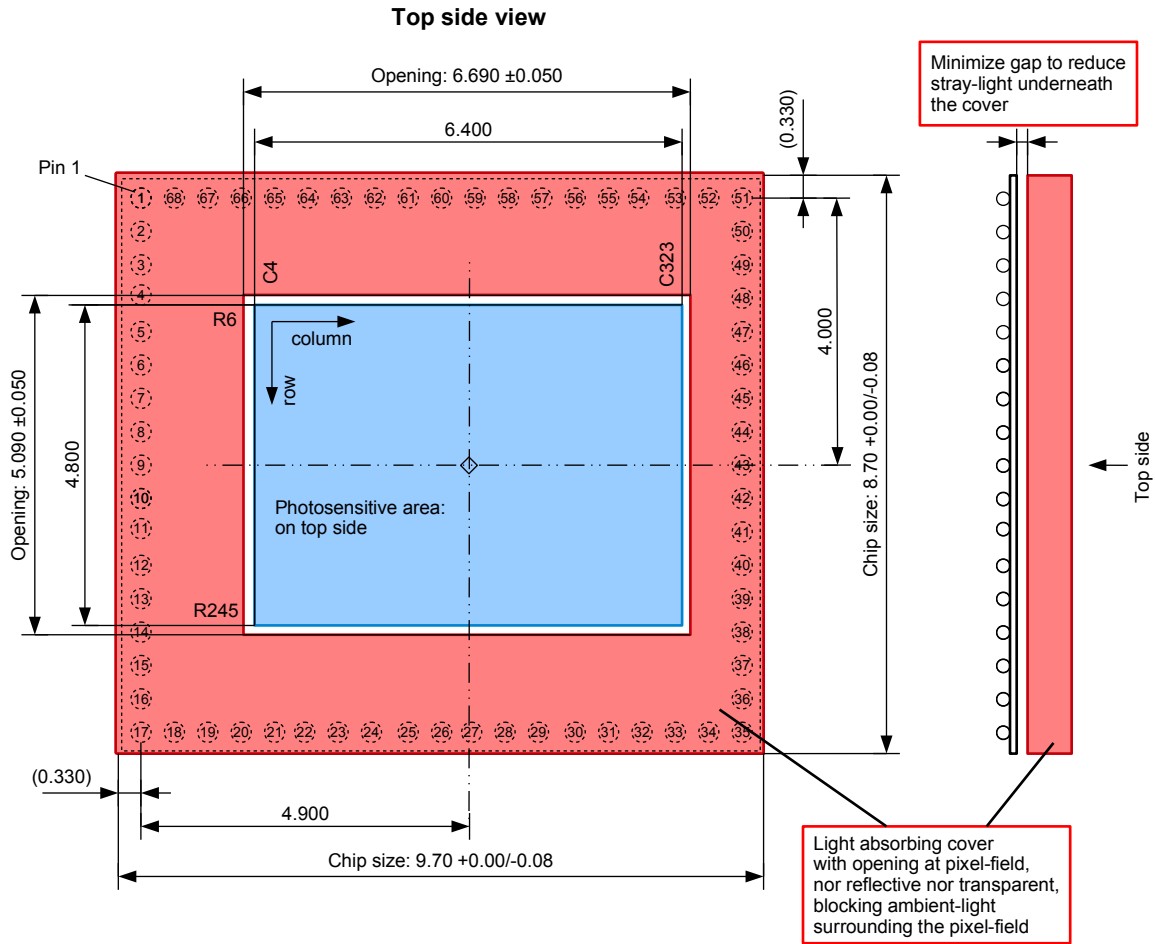
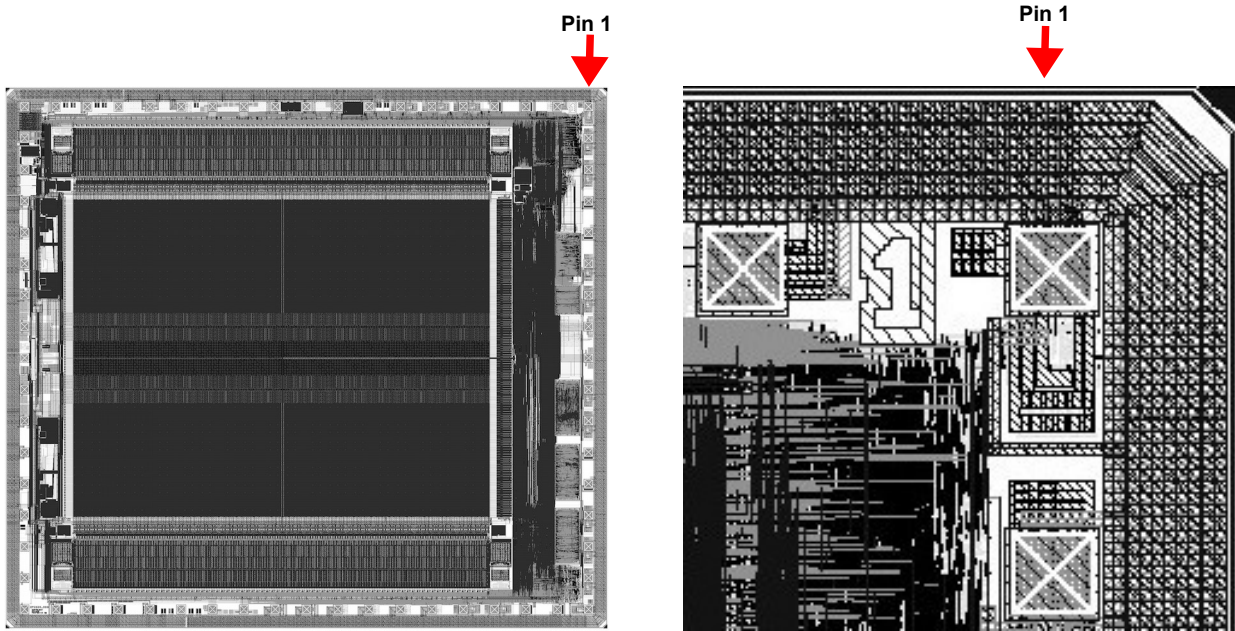

Figure 10: Opaque cover for protection against unwanted ambient-light

### 3.3. Pin1 marking

The following pictures shows the epc660 chip from the bottom side with view to the solder balls. Please note the location of pin 1. It's highly recommended to check the pin 1 orientation with a vision system during the SMT assembly process.



epc660 chip from the solder ball side

Top right corner from the solder ball side

Figure 11: Pin 1 marking

### 3.4. Location of the photosensitive area

The photosensitive area is not marked neither on the front nor on the backside of the IC. As a visible reference, a metal ring of the IC can be used. From the solder ball side it is visible. Also from the front side (photosensitive area) it can be seen with a camera which is sensitive in the near infrared wavelength domain (950 .. 1150nm).

### 3.5. PCB design and SMD manufacturing process considerations

As the epc660 chip comes in a 68 pin chip scale package with only 50µm thickness, the PCB layout should be made with special care. In addition, careful handling during the assembly process shall be assured in order to avoid mechanical damage during the assembly process. Because the silicon chip is small and light weight compared the solder balls, it is highly recommended that all tracks to the chip should come straight from the side. A symmetrical design is highly recommended to achieve high production yield. The pads and the tracks should also have exactly the same width at least for 1mm from the pad. They shall be covered by a solder resist mask in order to avoid drain of the solder tin alloy to the track.

As shown in 12, a ground plane shall be placed on the top PCB layer underneath the chip. This ground plane is the common GND point and acts as a shield to suppress high frequency emission of fast interface signal lines. It is important that this plane is completely flat. Thus, the plane must not be scattered nor divided into sections. It should be rather full-faced and evenly plane for vias placed underneath this plane. Otherwise chip bending might occur. In addition, the ground plane helps to dissipate the heat generated by the chip operation. A good heat dissipation is achieved if there is a temperature increase of the chip under normal operation of max. 20K. The temperature can be read direct from the chip.

Underfill of the component reduces stress to the solder pads caused by e.g. temperature cycling or mechanical bending. Furthermore the thermal and mechanical fatigue will be reduced and the longterm reliability will be increased. Underfill material and underfill selection is application specific. It shall follow JEDEC-STD JEP150: Stress-Test-Driven Qualification of and Failure Mechanisms Associated with Assembled Solid State Surface- Mount Components. Please also, refer to the application note AN08 Process-Rules CSP Assembly which can be downloaded from the ESPROS Website at [www.espros.com](http://www.espros.com), section Downloads. Obeying these recommendations is very important to achieve a high manufacturing yield and high reliability.

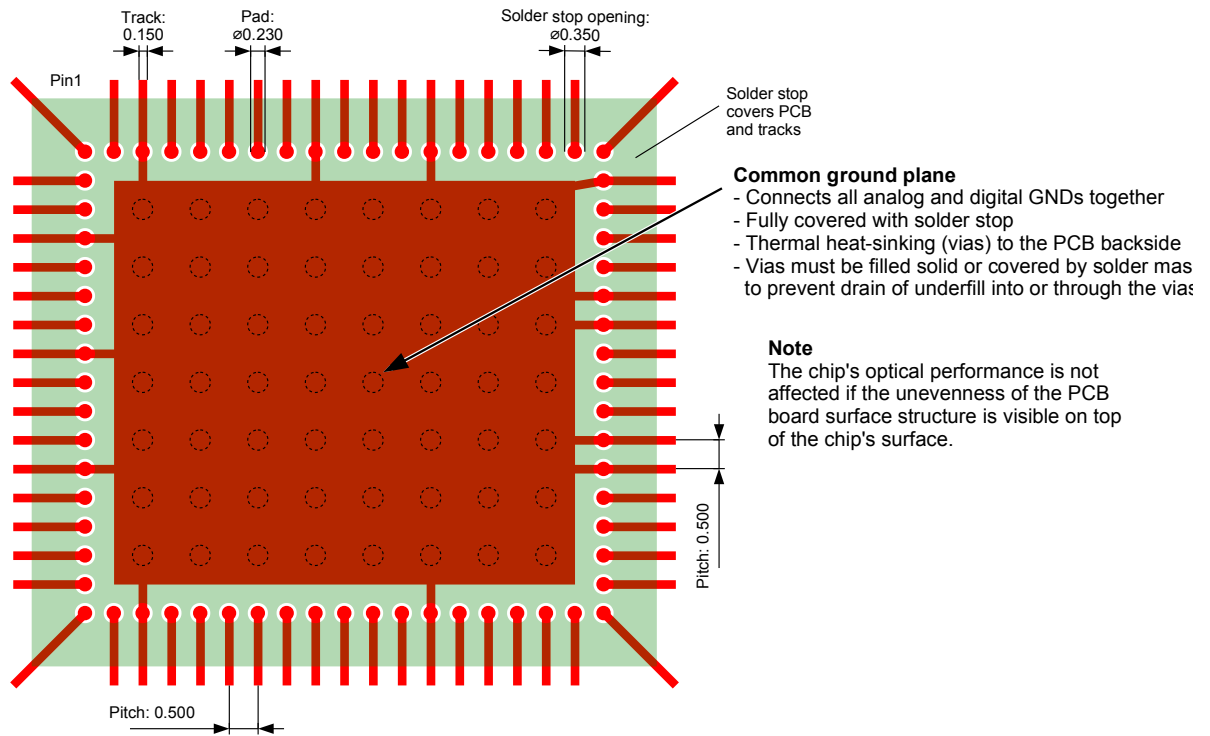

Figure 12: Recommended PCB layout (all measures in mm)

### 3.6. Packaging information

The devices will be shipped in standard JEDEC trays for automatic placement systems. General tray specification data are available in a separate datasheet. Further tray specifications can be found in the JEDEC Association standard JEP95.

The chips are placed according industry standard with pin 1 at the tray chamfer corner, refer to 13. ESPROS does not guarantee that there are no empty cavities. Thus, the pick-and-place machine should check the presence of a chip during picking. In addition, it should verify the correct location of pin 1 (refer to 11).

The trays are designed for vacuum pick-up and for a maximum temperature of 150°C.

Trays are packed and shipped in multiples of single trays with an empty cover tray on top. Trays are not a hermetic packaging. Thereof for storage and transportation, the tray stack is sealed in a moisture barrier bag.

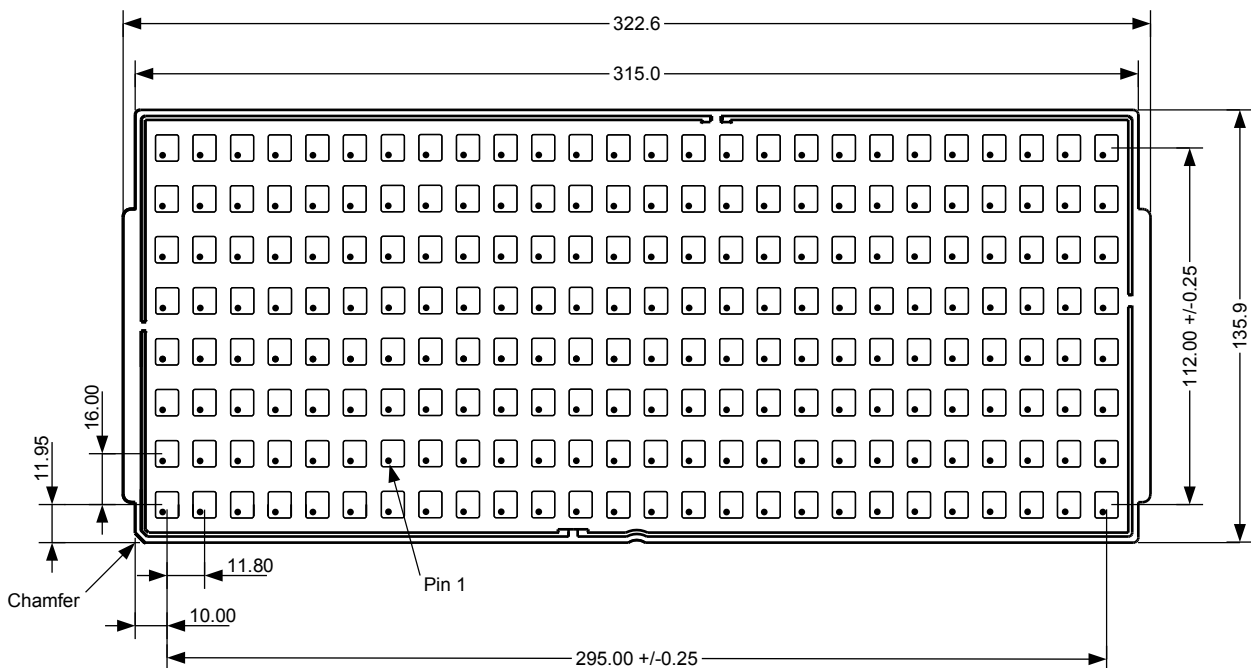

Figure 13: JEDEC tray for 26 x 8 pieces, maximum quantity 208 pieces per tray, use vacuum pick-up (all measures in mm)

## 4. Ordering information

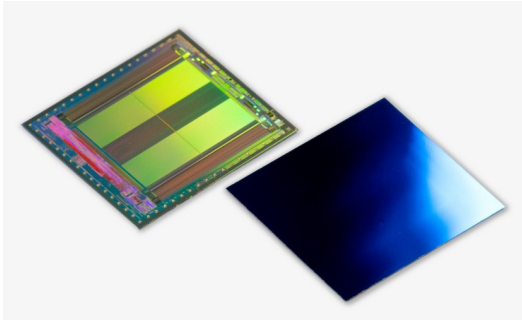

Figure 14: epc660-CSP68 bottom and top side



Figure 15: epc660 CC Chip Carrier, refer to separate datasheet

Part Number	Part Name	Package	RoHS compliance
P100 183	epc660-CSP68	CSP68	Yes
P100 244	epc660 CC Chip Carrier	PCB 37.25 x 36.00 mm	Yes

Table 10: Ordering Information

### 4.1. Notes to various chip releases

The supplied chip version can be identified by

- reading the extension -XXX of the part name on the packaging labels or delivery papers: epc660-CSP68-XXX.
- reading the part version register 0xFB: Refer to chapter 15.8.
- The latest download code for each chip version is included in the download package for the epc660 Evaluation Kit (see chapter 15.11).



# 5. Hardware implementation

## 5.1. Typical application diagram

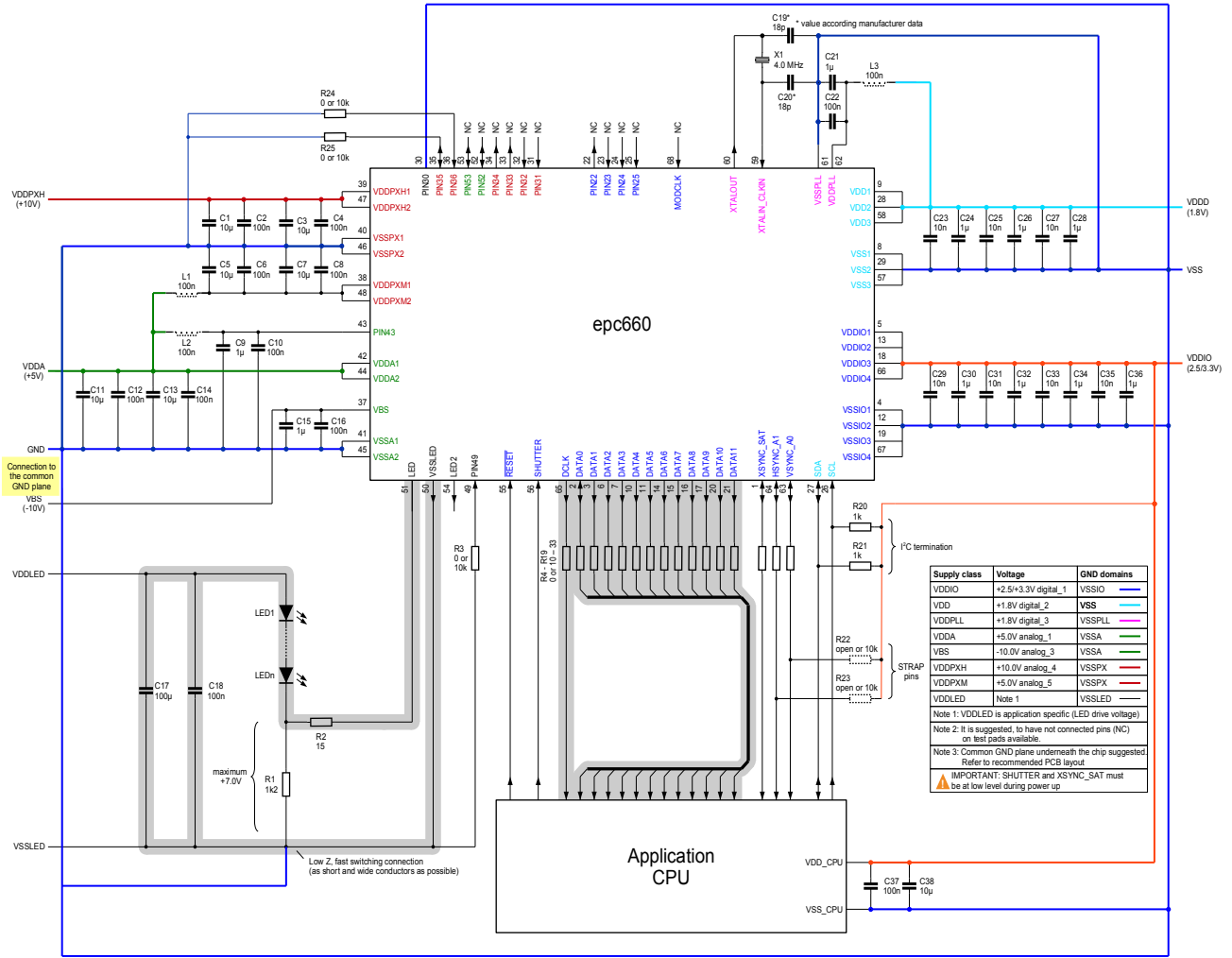

Figure 16: Typical application diagram

Notes:

R4-R19	Resistor value depends on fast bus decoupling, typically 33 Ohms.
R3, R24, R25	Pins need to be connected to GND. In case of need to testability: use 10k resistors.
R22, R23	Resistor value depends of needed strap function.
SHUTTER and XSYNC_SAT	Must be at low level until RESET release. Otherwise malfunction occurs.
VSS	Connect all VSS as direct as possible using vias to the GND plane underneath the imager

## 5.2. Application diagram part list

Part designator	Description	Pin No.	Value			Tolerance	Supply class V <sub>sc</sub>	Comments
			Min.	Typ.	Max.			
Minimum part count:								
C11	VDDA	41 – 42, (44 – 45)	10 µF			±20%	V <sub>DDA</sub>	Ceramic X7R
C12	VDDA	41 – 42, (44 – 45)		100 nF		±20%	V <sub>DDA</sub>	Ceramic X7R
C19, C20	XTAL	59 - 61, 60 - 61	---	18 pF <sup>2</sup>	---	±20%	V <sub>DDPLL</sub>	Ceramic NPO
X1	XTAL	59 - 60	---	4 MHz	---	±100ppm	V <sub>DDPLL</sub>	Quartz / Resonator
R20, R21	I <sup>2</sup> C pull-up			1 kOhm		±20%	V <sub>DDIO</sub>	Resistors
Dashed components improve signal quality, power supply quality or testability:								
C1, C3	VDDPXH	46 – 47, 39 - 40	10 µF			±20%	V <sub>DDPXH</sub>	Ceramic X7R
C5, C7	VDDPXM	46 – 48, 38 - 40	10 µF			±20%	V <sub>DDPXM</sub>	Ceramic X7R
C13	VDDA	44 – 45	10 µF			±20%	V <sub>DDA</sub>	Ceramic X7R
C9	PIN43	41 - 43	1 µF			±20%	V <sub>IR</sub>	Ceramic X7R
C15	VBS	37 - 41	1 µF			±20%	V <sub>BS</sub>	Ceramic X7R
C21	VDDPLL	61 - 62	1 µF			±20%	V <sub>DDPLL</sub>	Ceramic X7R
C24, C26, C28	VDD	8 – 9, 28 – 29, 57 - 58	1 µF			±20%	V <sub>DD</sub>	Ceramic X7R
C30, C32, C34, C36	VDDIO	4 – 5, 12 – 13, 18 – 19, 66 - 67	1 µF			±20%	V <sub>DDIO</sub>	Ceramic X7R
C2, C4	VDDPXH	46 – 47, 39 - 40		100 nF		±20%	V <sub>DDPXH</sub>	Ceramic X7R
C6, C8	VDDPXM	46 – 48, 38 - 40		100nF		±20%	V <sub>DDPXM</sub>	Ceramic X7R
C10	PIN43	41 – 43		100 nF		±20%	V <sub>IR</sub>	Ceramic X7R
C14	VDDA	44 – 45		100 nF		±20%	V <sub>DDA</sub>	Ceramic X7R
C16	VBS	37 - 41		100 nF		±20%	V <sub>BS</sub>	Ceramic X7R
C22	VDDPLL	61 - 62		100 nF		±20%	V <sub>DDPLL</sub>	Ceramic X7R
C23, C25, C27	VDD	8 – 9, 28 – 29, 57 - 58		10 nF		±20%	V <sub>DD</sub>	Ceramic X7R
C29, C31, C33, C35	VDDIO	4 – 5, 12 – 13, 18 – 19, 66 - 67		10 nF		±20%	V <sub>DDIO</sub>	Ceramic X7R
L1	VDDPXM	---		100 nH		±20%	V <sub>DDPXM</sub>	Inductor
L2	PIN43	---		100 nH		±20%	V <sub>IR</sub>	Inductor
L3	VDDPLL	---		100 nH		±20%	V <sub>DDPLL</sub>	Inductor
R4 - R19	Bus termination		0 Ohm	10 Ohm	33 Ohm	±20%	V <sub>DDIO</sub>	Resistors
R22, R23	I <sup>2</sup> C address			10 kOhm		±20%	V <sub>DDIO</sub>	Resistors

Table 11: Values of component related to epc660 chip, see 16

### Notes:

- <sup>1</sup> All other components are application specific.
- <sup>2</sup> The capacitor value has to be selected according the crystal or resonator supplier's recommendation.

## 5.3. Hardware implementation notes

- epc660 is supplied with +1.8V, +2.5/3.3V, +5V, +10V and -10V. See 16.
- Decoupling capacitors must be placed as close as possible to their supply pin pair in order to minimize ripple on the supply rails due to fast switching high-speed signals (11).
- +1.8V is used for supplying the digital logic (VDD), the on-chip oscillator OSC and the phase-look-loop PLL (VDDPLL). These supplies are marked in the application diagram as VDD and VDDPLL respectively (16). Their supply wiring must be separated from the digital wires and physically isolated from each other. The XTAL/OSC and PLL are critical parts of the chip which directly impacts the optical system performance (i.e. distance calculation). Thereof, the VDDPLL supply needs a well decoupling from VDD, because the digital logic creates some internal switching noise on VDD.
- +2.5/3.3V (VDDIO) is used for supplying the high-speed IO pins (MODCLK, TCMI and LED2) and the slow I<sup>2</sup>C pins. High speed TCMI pins toggle up to 48MHz during data transfer, hence generating continuously switching noise (much more dominant than the digital noise). Therefore, VDDIO supply wires and layers must be carefully designed and isolated in a separate supply island on the PCB. It is not recommend to change this voltage on the fly when the TCMI, LED2 or I<sup>2</sup>C interfaces are running. When the application needs

power saving during system idle periods, it can be scaled from +3.3V down to +2.5V, only after frame acquisition is stopped and both interfaces are completely inactivated. It can be increased back to +3.3V before re-activating the chip for frame acquisition, accessing I<sup>2</sup>C, LED2 or TCMI interface. Note that voltage scaling must be done in a controlled way having both application CPU's and epc660's IO voltages at the same time at the same level.

5. +5V is used for supplying analog blocks of the chip e.g. pixel-field drivers and ADC readout circuitry. Refer to 16.
6. +10V (VDDPXH) is used for supplying the pixel-field circuitry.
7. -10V (VBS) is used for biasing the the pixel-field like reverse-biasing a photodiode. The use of a stable supply source with a low ripple is recommended. There is no switching or active internal circuit dependent current consumption, except ambient-light dependent leakage current (refer to 1, note 8).
8. A 4MHz quartz crystal or a ceramic resonator is connected to XTALIN\_CLKIN and XTALOUT pins in order to use internal oscillator OSC as time base for the epc660. The frequency accuracy and stability are directly related to the distance readings. Alternatively an external clock source can be used (chapter 5.4).
9. MODCLK input can be used for user controlled/modulated clock. It is used for both the LED driver and the pixel-field demodulator.
10. SCL, SDA are I<sup>2</sup>C slave pins which need external pull-up resistors on the PCB (see also VDDIO supply). Values of R20 and R21 are given only for indicative purpose and must be re-calculated according to the total capacitive load of all I<sup>2</sup>C slave/master devices and the operating mode FM or FM+ of the I<sup>2</sup>C (chapter 13) in the application.
11. VSYNC\_A0, HSYNC\_A1, XSYNC\_SAT, DATA[11:0], DCLK, high-speed TCMI signals (chapter 6), SHUTTER and RESET control signals toggle in the VDDIO range. To minimize the skew, the high-speed \*SYNC, DATA[11:0], DCLK signals wires must be routed equal in impedance and length less than 10cm long with less than 10mm difference on the PCB. As they are toggling all the time, they can be separated with ground wires on the side adjacent to other signals/supply lines, routed with enough distance from other sensitive signal wires on the board. Series termination resistors R4 ... R19 (10 ... 33Ω) are needed at high-speed outputs to control the slew.
12. Optional pull-up resistors R22 and R23 (10kΩ) set initial values of some configuration registers during start up of the chip. Such outputs pins are called strap pins. They are scanned one time immediately after RESET is released (chapter 5.6.3).
13. The LED pin is an open-drain LED/LD driver output. When the driver is active (on), the LED/LD on-current flows through the power resistor R2 into the LED pin, through the driver and comes out of the chip on the VSSLED ground pin. The LED pin toggles up to 24MHz or according to the MODCLK clock with a current maximum of 200mA limited by the resistor R2. The number of IR LEDs depends on the level of the LED supply voltage and the turned-on forward voltage drop of the IR LEDs. This signal creates a lot of ground noise. Therefore, VSSLED pin is decoupled from the other analog grounds internally. It must be shorted with the other analog ground pins with a low-ohmic connection as short as possible on the PCB. In this way, there will be minimal voltage differences in the ground planes of the board. The LED supply line must be isolated properly from any analog supply on the PCB to minimize noise coupling from the LED drivers.

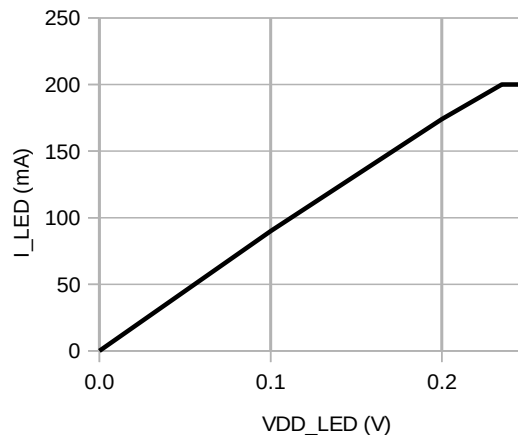

Figure 17: Output characteristic  $I_{LED}$  versus  $V_{DDLED}$ . Refer for maximum values of  $V_{DDLED}$  and  $I_{LED}$  to 1 and 2

14. The LED2 pin is the alternative push-pull driver providing symmetric rise/fall times to drive external LED driver. It works from the +2.5/+3.3 VDDIO supply (VSSIO GND domain) and swings in the same voltage range like the TCMI pins. LED2 = LOW (approx. 0V) corresponds to LED = OFF (max. output voltage). LED and LED2 pins must not be used at the same time for driving the external illumination. They exhibit different phase delays and this can result wrong distance measurements. None of the TCMI pads toggle during integration time, LED2 pin is the only toggling during integration time and it is not affected from switching noise of others.
15. It is recommended having "not connected pins" (PINxx) on test pads available. It helps e.g. to check after assembly for correct orientation of the chip or for short-cuts.
16. Pins not listed here have to be connected according 16.

### 5.4. Clock source

Instead of a crystal, an external 4MHz clock source can be connected to the XTALIN\_CLKIN pin. XTALOUT output pin left unconnected. Input clock signal levels must match VDDPLL/VSSPLL supply levels (1). If the external clock source comes from the +2.5/3.3V voltage domain, a resistor divider circuit can be deployed to adjust the voltage level according to 18.

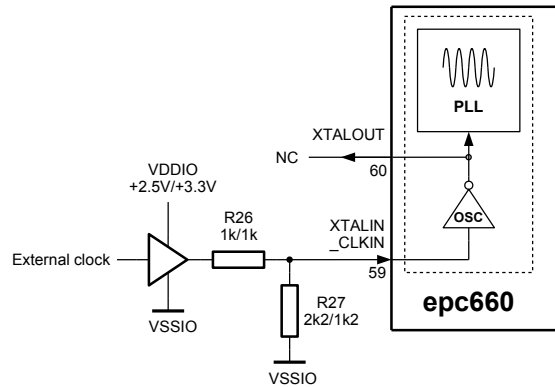

Figure 18: Resistor divider to adjust external clock voltage levels to XTALIN\_CLKIN

**IMPORTANT:** The optical performance of the chip directly depends on the input clock precision/stability. XTALOUT must not be used to drive external loads.

### 5.5. External modulation MODCLK

The epc660 has for enhanced user applications the possibility to bring an external modulation clock to the chip. The optional MODCLK input can be used to inject a user controlled/modulated clock for both the LED driver and the pixel demodulator, see 19.

The external MODCLK can be used e.g. in concepts for reliable multi camera applications. It allows to use e.g. frequency-division multiple access (FDMA). In corresponding literature, the details of these concepts are explained in detail.

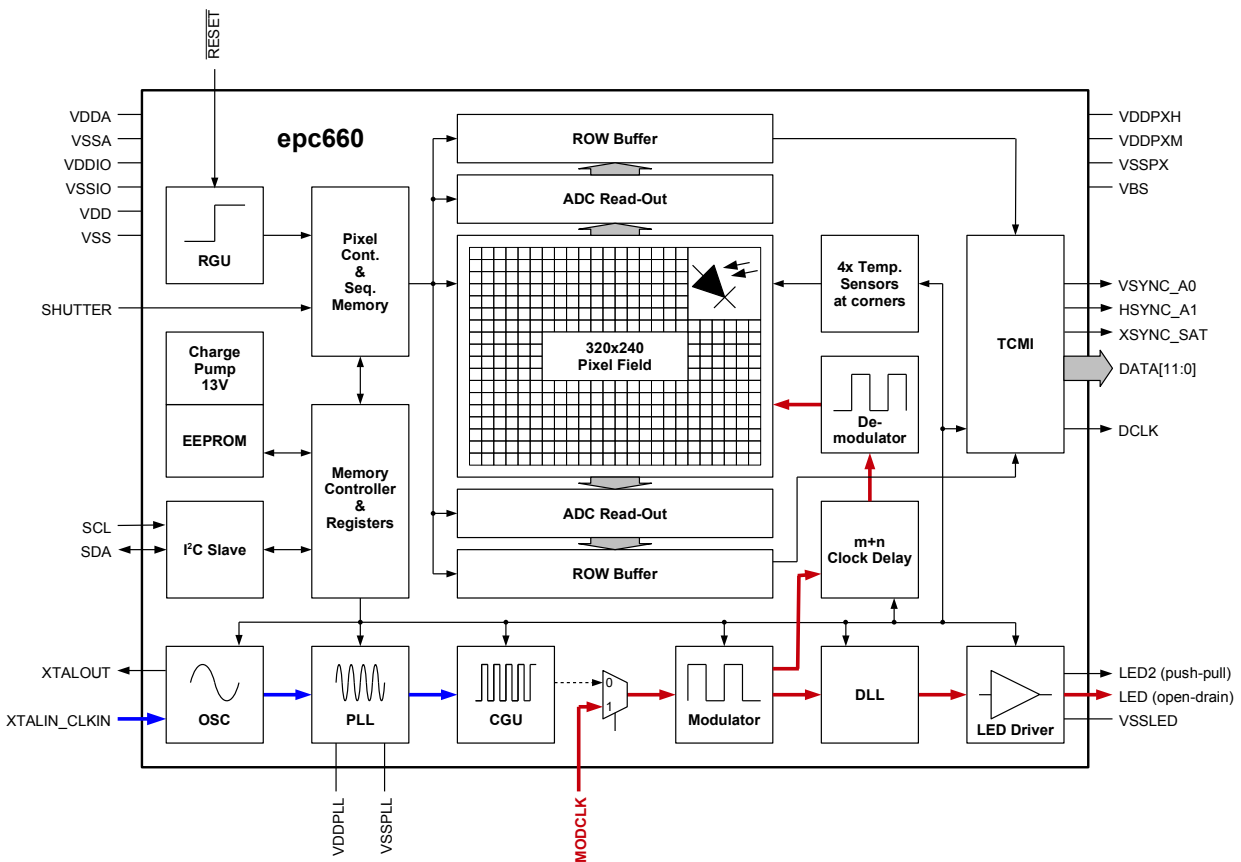

Figure 19: The MODCLK signal flow (red marked)

The user is free to apply any digital waveform up to 96MHz during frame acquisition as external MODCLK signal. Even more, he is also free to use modulations like pseudo-random edge jitter, dithering, etc.

The signal from the MODCLK pin is used instead of the clock generated by the CGU if bit 6 in register 0x80 is set to 1. The effective modulation signal is the MODCLK divided by 4.

The unambiguity range and the integration time are in this case based on the MODCLK:

$$[1] \quad t_{INT} = \frac{\text{reg}(0x85)+1}{\text{MODCLK}} \cdot [\text{reg}(0xA2:0xA3)+1] \cdot \text{reg}(0xA0:0xA1)$$

For more details refer to chapter 9.2.1 and 11.4. Note, register 0x85 is active in this mode.

## 5.6. Supply, reset and start-up options

### 5.6.1. Supply voltages and external reset

During the power-up sequence, VDD and VDDPLL supplies (20) must be applied at the same time to the epc660. VDDIO can be applied either at the same time or after VDD and VDDPLL supplies become stable. In a system where VDDIO voltage is connected in parallel to application CPU IO supply pins (see 16), VDD and VDDPLL can be generated by a linear regulator directly from VDDIO supply. In this case, all these three supplies ramp together.

VDDA, VDDPXM and VDDPXH supplies must be applied as a second group, after all VDD, VDDPLL and VDDIO supplies become stable.

The negative supply VBS must be applied after all positive supplies reached their rated levels.

Image acquisition shall not start before all supply voltage are at their stable level.

$\overline{\text{RESET}}$  must be kept low while all positive voltages are ramping-up in order to guarantee proper reset of all internal circuits. As soon as rated positive levels are reached,  $\overline{\text{RESET}}$  can be set to high. In case of an external clock is applied at XTALIN\_CLKIN instead of a crystal/resonator is used with on-chip OSC, clock must be present before  $\overline{\text{RESET}}$  is released.

#### IMPORTANT:

- It is possible to shutdown entire supplies for a very low standby current. In that case, first  $\overline{\text{RESET}}$  must be driven low, then supplies must be turned off in the reverse order. Refer for details to chapter 11.6
- VDDA, VDDPXM and VDDPXH supplies must never kept on while turning off VDD, VDDPLL and VDDIO. Damage to the chip can be the result.

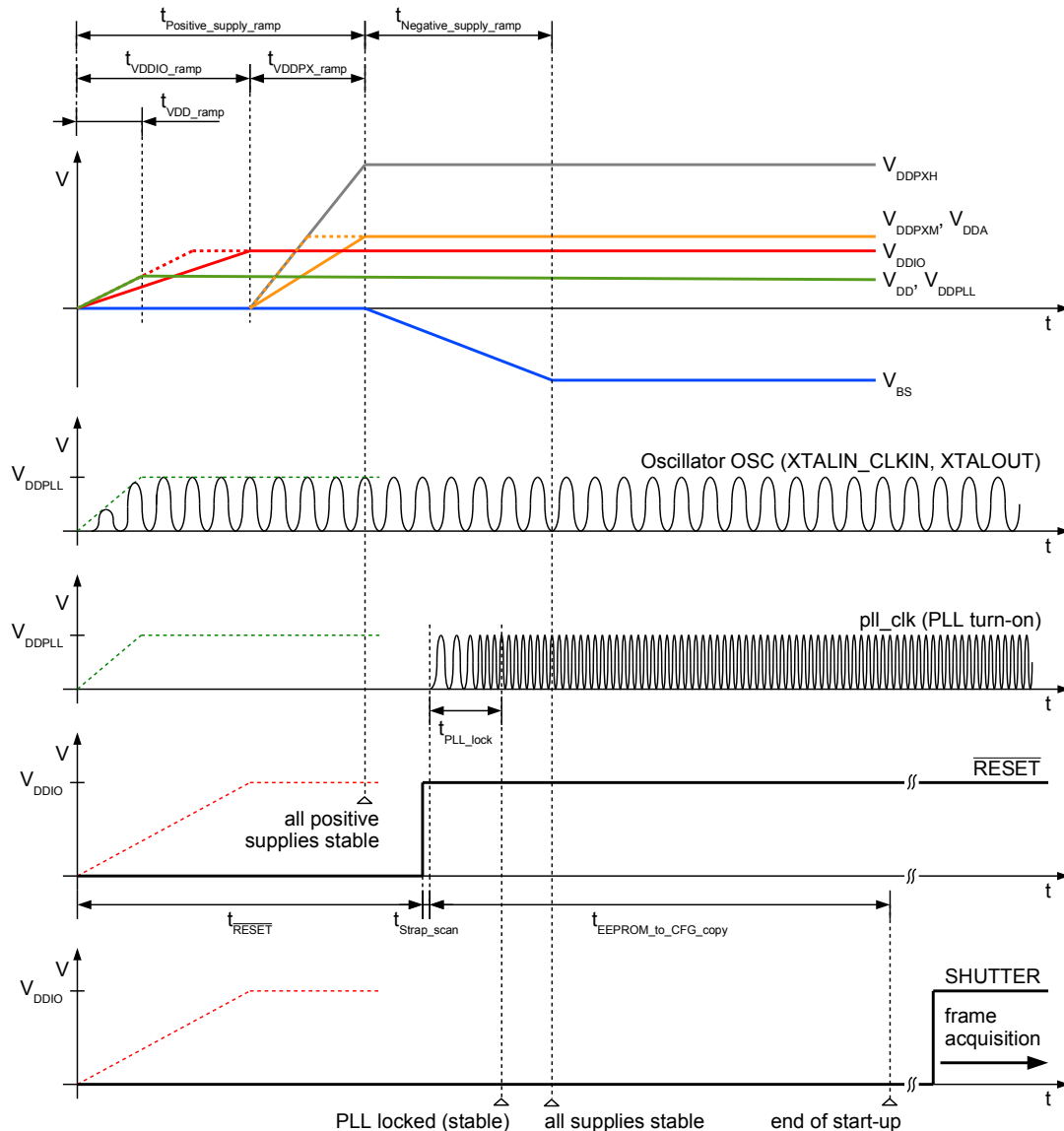

Figure 20: Power-up and reset sequence

### 5.6.2. Start-up (Clock, PLL turn-on and EEPROM copy)

The epc660 starts using either the internal 4MHz oscillator OSC with a crystal/resonator (16) or an external 4MHz clock, followed by an EEPROM copy sequence in parallel to the PLL turn-on phase. This is the factory default configuration. Several configuration registers are modified by copying the EEPROM content (62, i.e. overwrite reset values).

### 5.6.3. Strap pins

The epc660 has output pins with dual/alternative functionality for PCB level flexible start-up configuration changing, called 'strap pins'. RESET release is followed by a strap pin scanning step. The chip programs its strap pins as inputs with internal pull-down resistors enabled for 4 osc\_clk periods (refer to 1 and 3.). If there is no external pull-up resistor connected, the corresponding strap pin will be scanned as logic 0 due to the internal pull-down resistor. If there is an external pull-up resistor connected (16), it will override the internal pull-down and corresponding pin will be scanned as logic 1. After the strap scan period, pins are programmed back as outputs so that they can be used for their main function. Strap pins and their definitions are listed below (12).

Pin	Pin no.	Definition
HSYNC_A1	64	Set A1 bit of 7-bit I <sup>2</sup> C slave device address (section 13.1).
VSYNC_A0	63	Set A0 bit of 7-bit I <sup>2</sup> C slave device address (section 13.1).
XSYNC, DATA0	1, 2	Factory used strap pins. No pull-up resistors allowed

Table 12: Strap pin definition

### 5.7. LED driver

The LED driver register 0x90 is used for setting polarity etc. depending on the external LED/LD circuitry used in the application. These bit fields must not be modified during frame acquisition.

**IMPORTANT:** There are non-modulating DC modes (e.g. grayscale with LED/LD illumination) which keeps the LED driver always turned on. In this case, the user has to take care that LED driver and the epc660 chip does not exceed the maximum operating limits.

### 5.8. DLL (Delay Line)

The modulation signal can intentionally be delayed in order to add a phase shift between the modulation of the light source and the demodulation of the backscattered light, refer to 21.

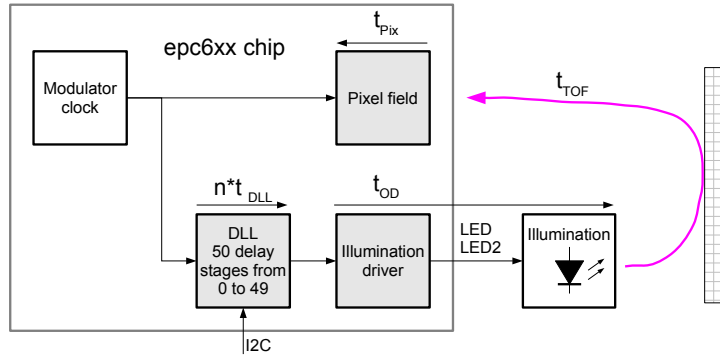

Figure 21: Block diagram of the DLL function

The purpose to do so can be that the phase shift between the modulated and the demodulated signal in a specific distance range should be at a certain value. For example, the highest distance accuracy with lowest distance noise can be achieved when the phase angle of demodulation is 45°. This is the case when all four DCS amplitudes have the same or a similar value. The worst situation is if one DCS pair is at its maximal amplitude whereas the other DCS pair is around zero (refer to 22).

The DLL can be enabled in register 0xAE whereas the delay of the LED modulation can be set in steps  $t_{DLL}$  by register 0x73 (approx. 2ns/step). The exact step  $t_{DLL}$  can be calculated with the value and the formula listed in register 0xE9. This value is varying from chip to chip and is also temperature dependent. The user shall characterize the overall temperature drift of the complete camera for matching the compensation.

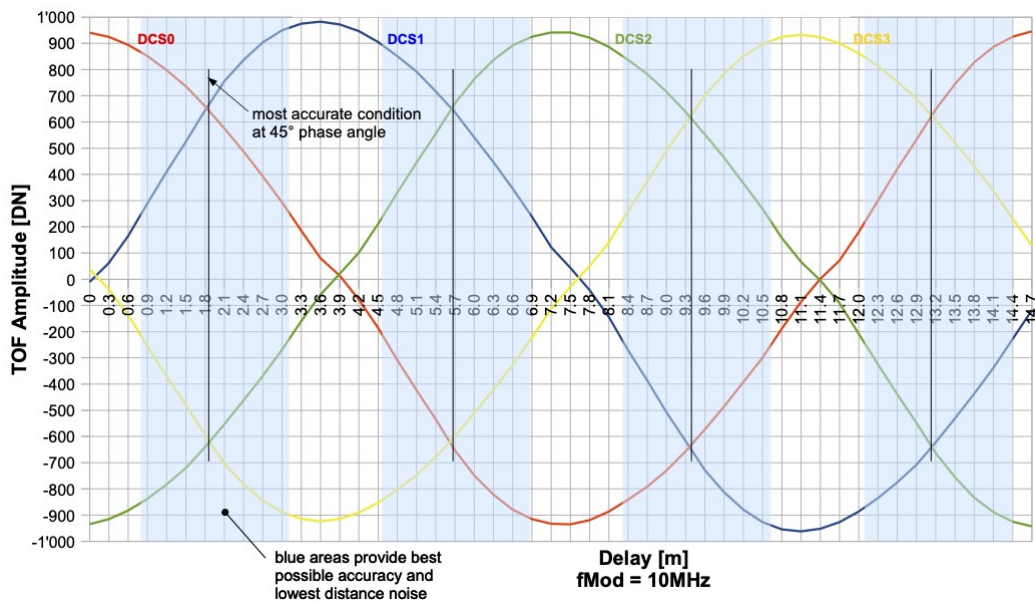

Figure 22: DCS amplitudes for the 4 DCSx (measurement data)

#### Example for 10MHz modulation frequency:

If we want to optimize the accuracy of our TOF camera in the short range domain, e.g. 0m to 1m, the situation shown in 22 is not ideal at all. The modulation frequency of the data shown in 22 is 10MHz whereas 50 DLL Steps of approx. 2ns are equivalent to 15m distance. Shown in the diagram, the worst condition is in the first three DLL steps, which is equal to 0m to 0.9m. From then on, the distance accuracy becomes much better until DLL step 12. In other words, the distance accuracy from distance 0.9m to 3.0m is very good, but not from 0m to 0.9m. In order to be in an accurate distance measurement regime, the DLL should be shifted by 3 steps which means that the LED is delayed by 6ns.

### 5.9. Application system overview

23 and 24 show a typical application block and data flow diagram. The epc660 chip acquires image data, controlled via the I<sup>2</sup>C interface, and then submits the data via the TCMI to an FPGA or microcontroller. The FPGA or microcontroller calculates the distance from the DCS and does filtering, correction and compensation and provides a cleaned “point cloud” to the host system.

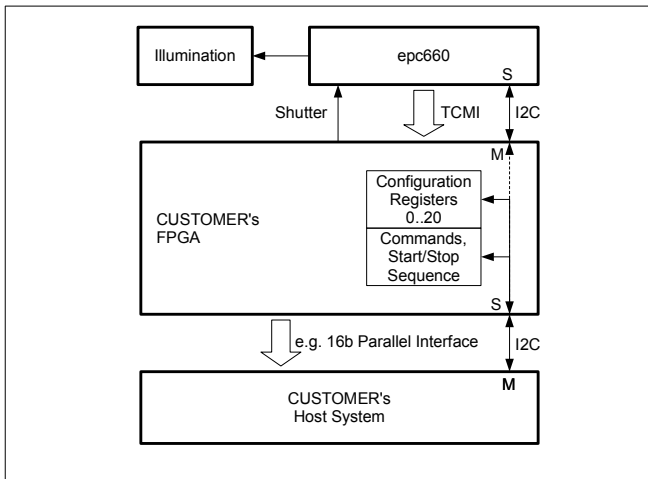

Figure 23: Block diagram

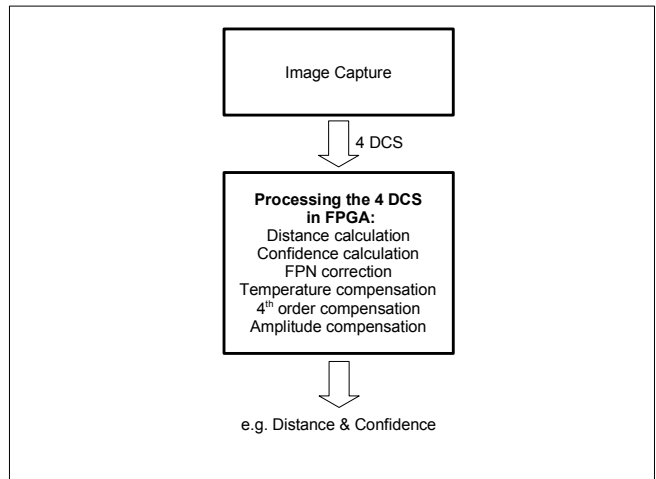

Figure 24: Data flow



## 6. TOF camera interface (TCMI)

The TOF Camera Module Interface (TCMI) is a programmable high-speed parallel data output interface to download the pixel data. It can be programmed very flexible via the registers 0x89, 0xCB and 0xCC.

When the integration period is completed and ADC conversion is finished, the readout results are moved into the data out buffers to be immediately transmitted via the TCMI interface. The ADC conversion is two full rows in parallel (top and bottom pixel-field) and the conversion time is independent of the number of selected columns. Depending of the mode selection (4x DCS, 2x DCS, ...) a programmable number of DCS frames are generated. The data is streamed out as a complete block of 1 DCS frame, one after the other. Each row contains 12-bit DCS values and the SAT bit. The pixel values are streamed out as 12 bit signed numbers. Two rows are streamed out in sequence together, the first one from the top and the second one from the bottom pixel-field e.g. R125 (C4, C5, ... C323), R126 (C4, C5, ... C323), R124 (C4, C5, ... C323), R127 (C4, C5, ... C323) and so on until R6 (C4, C5, ... C323), R245 (C4, C5, ... C323). The stream-out of a row pair takes 26.7µs with default clock settings (24MHz TCMI clock rate).

The transfer of a DCS frame cannot be interrupted or stopped, once it is started. The application should have enough bandwidth to receive all transmitted frames.

**IMPORTANT:** Refer to register 0xCC for setting correct data format.

### 6.1. TCMI clock

The TCMI interface supports the continuous clock mode with DCLK signal toggling continuously. It transmits the frames at high-speed using all \*SYNC (VSYNC\_A0, HSYNC\_A1, XSYNC\_SAT), DATA[11:0] and DCLK outputs (25). The DCLK frequency is programmable to 12, 24, 48 MHz via register 0x89.

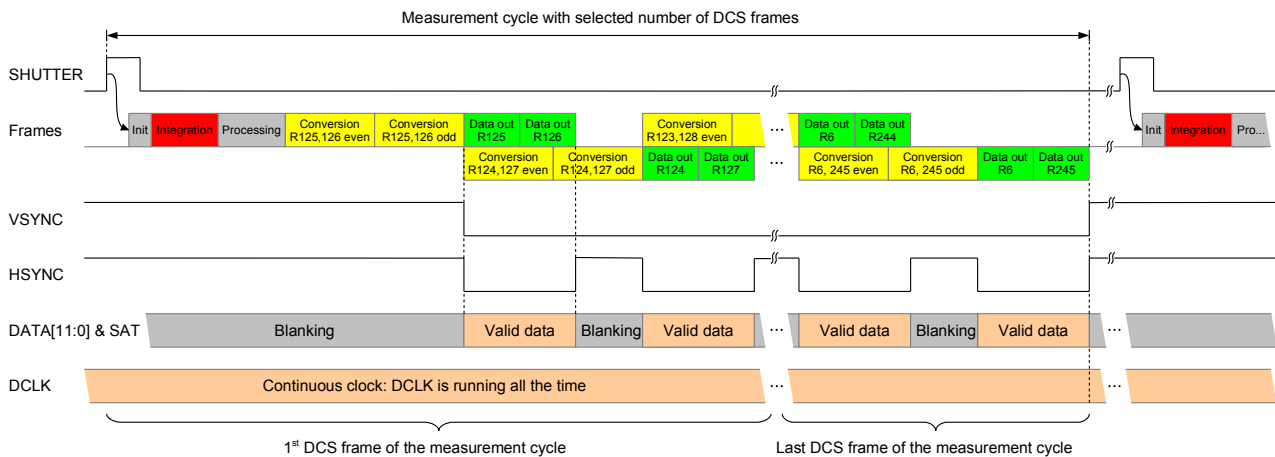

Figure 25: Continuous clock mode

All \*SYNC\*, DATA[11:0] signals are synchronously updated with the positive edge of the DCLK signal when its polarity is set as active-high; with the negative edge of the DCLK signal when its polarity is set as active-low. The non-active edge of the DCLK output can be used by the receiving end (application CPU) as a sampling clock. It should approximately be in the center of the data (refer to 27). By using the default configuration, the active states of VSYNC\_A0 and HSYNC\_A1 signals indicate blanking periods during the frame transmission. While DCLK toggles continuously, any data during the blanking periods are not valid and must be ignored.

As soon as the measurement result of the first row of the new frame is available, VSYNC\_A0 and HSYNC\_A1 are set consecutively with the next active edge of DCLK. VSYNC\_A0 is active from the start until the end of the each complete frame. Whereas, HSYNC\_A1 indicates the validity of the DATA[11:0] and XSYNC\_SAT (saturation bit) from the start until the end of a row pair.

By default, the XSYNC\_SAT pin is used for the saturation bit. Optionally, it can be programmed to indicate the end of a frame by disabling bit 6 in register 0xCC.

### 6.2. Single or continuous measurement control

#### 6.2.1. Single measurement control

The selected measurement mode (4x DCS, 2x DCS, grayscale, ...) defines, how many frames the chip performs by the stimulation of one SHUTTER pulse for a measurement cycle. This pulse can be applied either by the HW SHUTTER pin or by SW control with bit 0 in register 0xA4. Whereas the SW controlled SHUTTER is auto-cleared after propagation, the HW Shutter needs a minimum hold time of 250ns and must be set back manually latest before the HSYNC\_A1 signal of the last row pair of the last DCS frame (last HSYNC\_A1 of the last frame). During such a measurement cycle, the next frame acquisition starts immediately after the last data readout on the TCMI interface until all frames are performed.

#### 6.2.2. Continuous measurement control (auto-run)

As long as in the shutter control register 0xA4, bit 1 is set or the HW SHUTTER is applied during the readout of the last row pair of the last frame, the epc660 runs in a non-stop measurement mode. The chip starts immediately next measurement cycle if the actual one is terminated (29). Trigger signals not active during the readout of the last row pair of the last frame are ignored.

### 6.3. TCMI timing

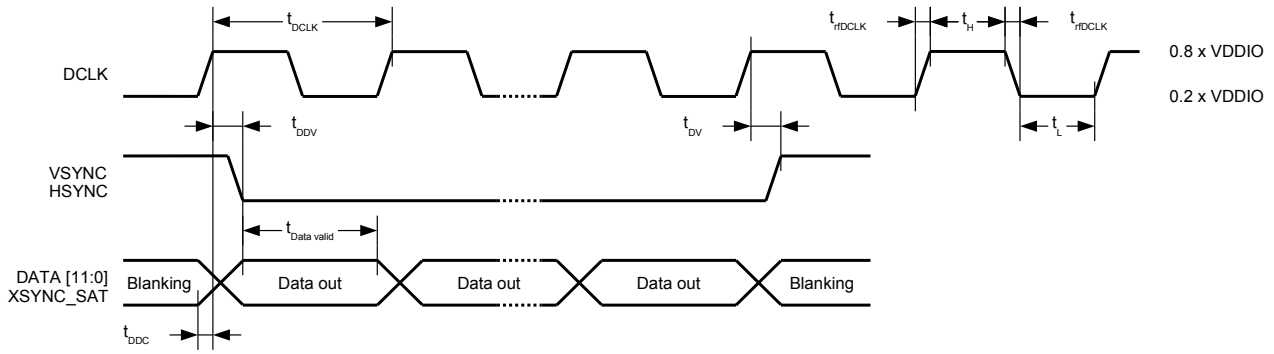
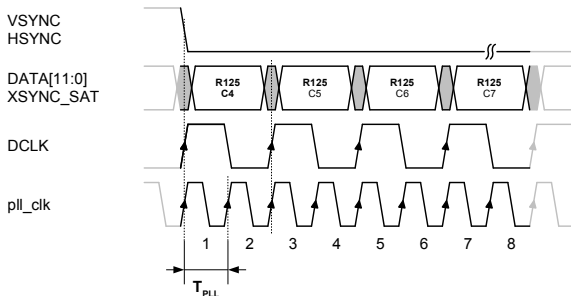

Figure 26: Detailed TCMI timing

Symbol	Parameter	Min.	Typ.	Max.	Units
$t_{DCLK}$	TCMI readout clock: typ. $f_{DCLK} = 24\text{MHz}$ / max. $f_{DCLK} = 48\text{MHz}$		41.6	20.8	ns
$t_{DDV}$	Delay time after positive edge of DCLK until data are valid			2.0	ns
$t_{DDC}$	Data start changing before positive edge of DCLK			1.7	ns
$t_{rDCLK}$	Rise and fall time of DCLK, VSYNC, HSYNC, XSYNC, Data[11:0]			2.0	ns
$t_H$	High period of DCLK	5.0			ns
$t_L$	Low period of DCLK	3.5			ns
$t_{Data\ valid}$	Output data on the TCMI interface are valid (depends on DCLK)	8.8			ns

Table 13: TCMI timing parameters ( $C_L = 20\text{ pF max.}$ )



TCMI detailed bus timing: DCLK=48MHz ( $pll\_clk / 2$ )

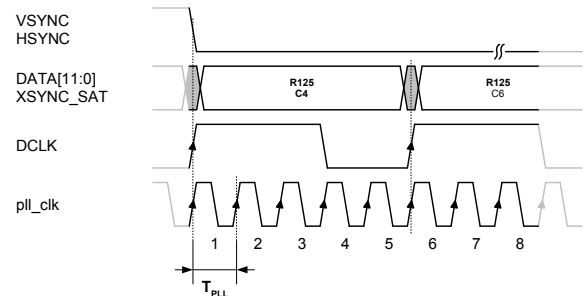

TCMI detailed bus timing: DCLK=19.2MHz ( $pll\_clk / 5$ )

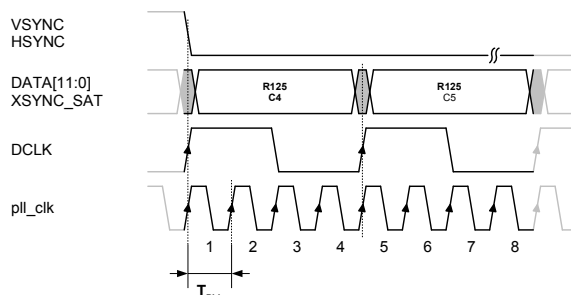

TCMI detailed bus timing: DCLK=24MHz ( $pll\_clk / 4$ )

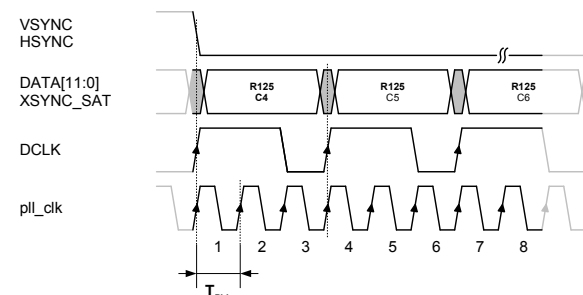

TCMI detailed bus timing: DCLK=32MHz ( $pll\_clk / 3$ )

Figure 27: TCMI timing examples with symmetric and asymmetric DCLK

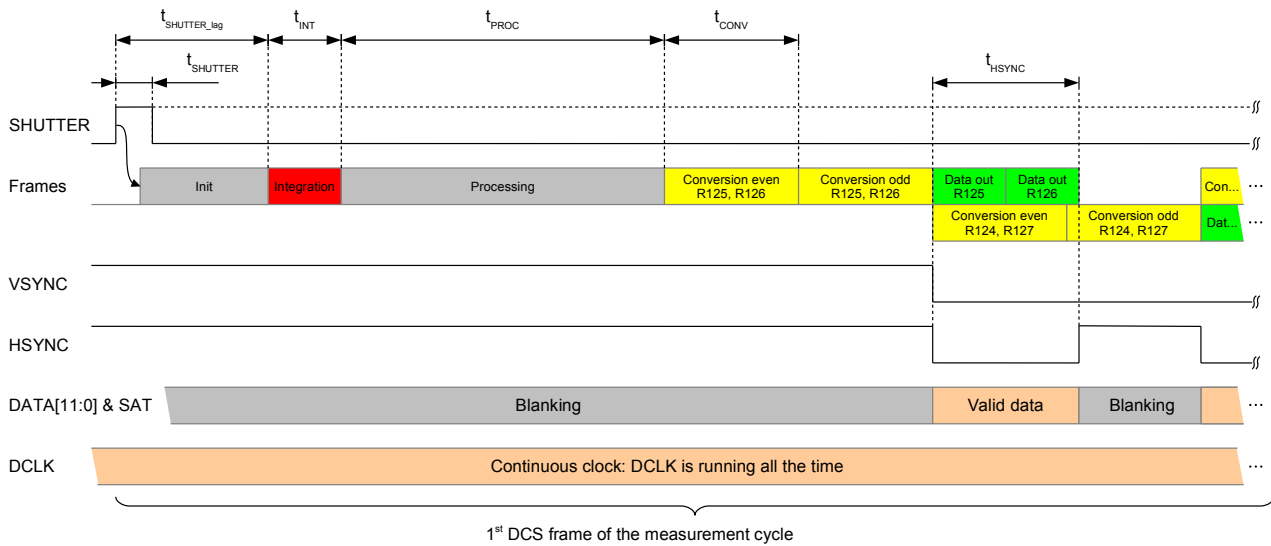

Figure 28: Frame timing: Start 1<sup>st</sup> DCS frame

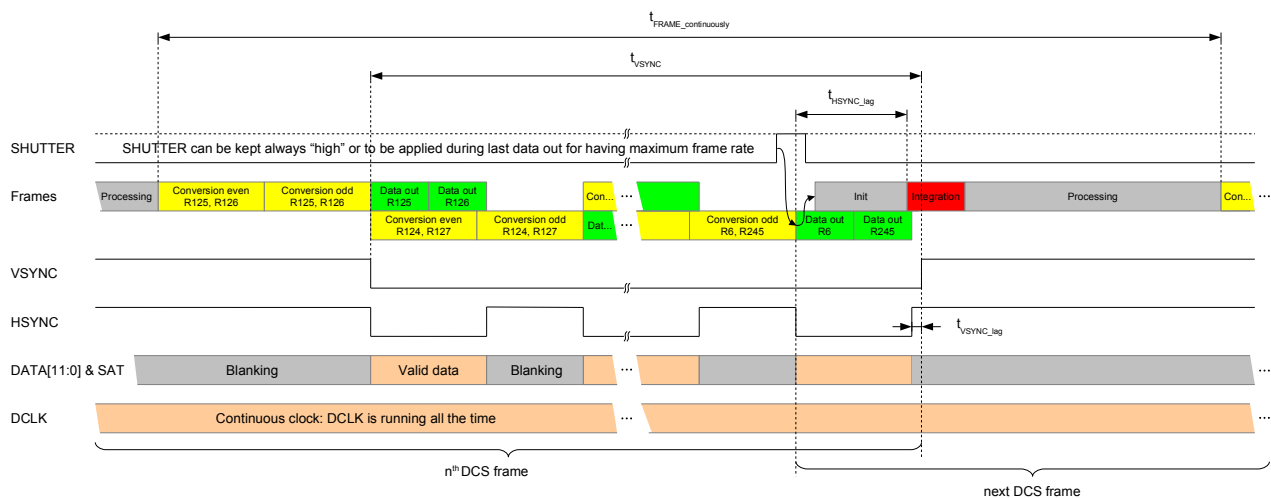

Figure 29: Frame timing: Inter frame timing, end of frame and start next frame

**Note:**

To avoid readout rollover when using slower DCLK with default ROI (< 13MHz, register 0x89 > 0x06), register 0x91, bit 6 must be enabled. It stretches HSYNC for slower TCMI interfaces. It causes a reduced DCS frame rate due to additional 2µs per ADC conversion ( $t_{conv} + 2\mu s$ ).

**6.4. TCMI data format**

TCMI supports one 12 bit and three 8 bit transfer formats:

- 12-bit mode: Transfers 12 bit pixel data with 1x DCLK (default). Refer to 30.
- msb/lbs split mode: Transfers 12 bit pixel data with MSByte leading and LSByte trailing with 2x DCLK. Refer to 14 and 31.
- lsb/msb split mode: Transfers 12 bit pixel data with LSByte leading and MSByte trailing with 2x DCLK. Refer to 15 and 32.
- 8-bit mode: Transfers the 8 MSB bits of the pixel data with 1x DCLK. Refer to 16 and 34.

12-bit mode uses all lines DATA[11:0]. Whereas the three 8-bit modes require only lines DATA[7:0] to be connected in the application. The TCMI data format can be selected in the register 0xCB.

The two split modes transmit pixel values in two consecutive DCLK cycles. As a result HSYNC time is doubled. When 8 bit precision is enough, the application can use 8-bit mode.

1st Byte: MSByte								2nd Byte: LSByte							
D7	D6	D5	D4	D3	D2	D1	D0	D7	D6	D5	D4	D3	D2	D1	D0
SAT	0	0	0	b11	b10	b9	b8	b7	b6	b5	b4	b3	b2	b1	b0

Table 14: TCMI msb/lbs split mode

1st Byte: <b>LSByte</b>								2nd Byte: <b>MSByte</b>							
D7	D6	D5	D4	D3	D2	D1	D0	D7	D6	D5	D4	D3	D2	D1	D0
b7	b6	b5	b4	b3	b2	b1	b0	SAT	0	0	0	b11	b10	b9	b8

Table 15: TCMI **lsb/msb** split mode

Byte							
D7	D6	D5	D4	D3	D2	D1	D0
b11	b10	b9	b8	b7	b6	b5	b4

Table 16: TCMI 8-bit mode , HW synchronization data format

The saturation flag can be optionally inserted into the DATA[7] of the MSByte by setting bit 6 in register 0xCB during the first or second DCLK cycle for the msb/lsb or lsb/msb split modes, respectively. This feature is not available for the 12-bit and 8-bit mode. In this cases either the XSYNC\_SAT pin can be used along with the DATA[\*] pins or bit 7 in register 0xCC must be set to force all DATA[\*] = 0xFFF when the corresponding pixel is saturated.

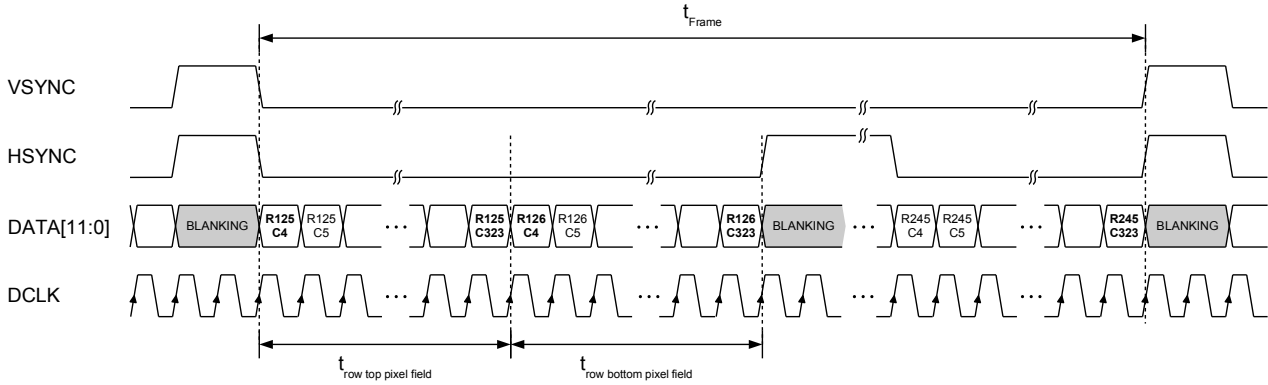

Figure 30: 12-bit mode data readout

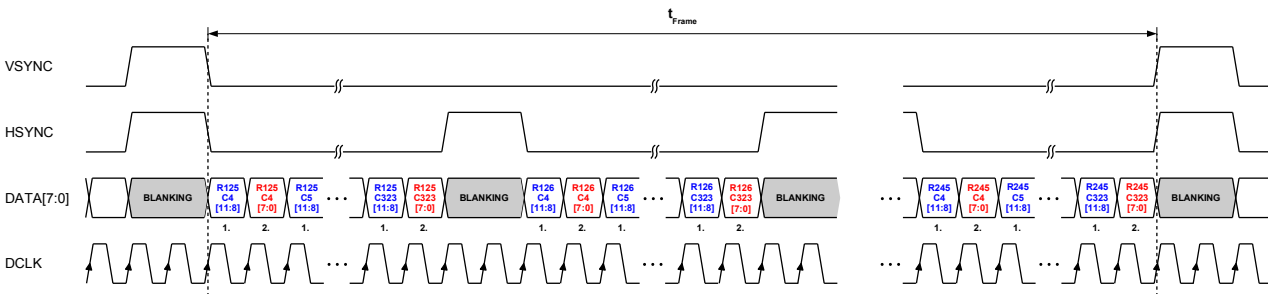

Figure 31: **msb/lsb** split mode

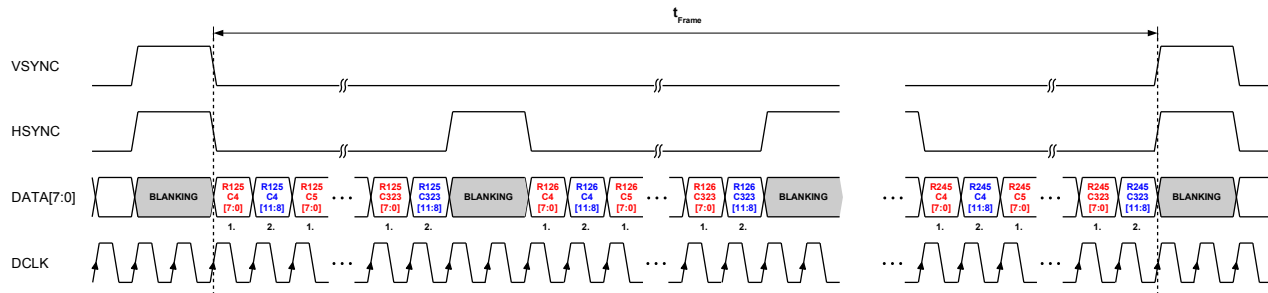

Figure 32: **lsb/msb** split mode

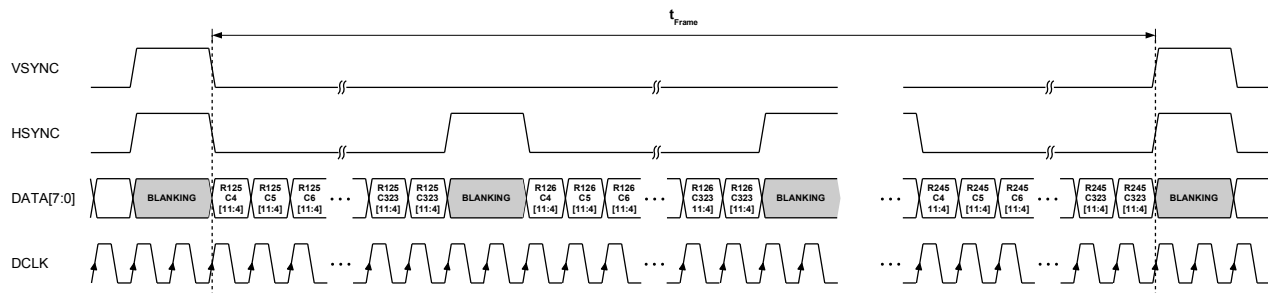

Figure 33: 8-bit mode

## 6.5. Frame rate and data-out performance

### 6.5.1. Frame rate QVGA 320x240 pixel (default)

The epc660 can perform a maximum of 158 fps with 1µs integration time, 12MHz modulation clock, 48MHz DCLK, 1x DCS and continuous measurement control. For 3D TOF, each frame is referred as a DCS frame. Either 4x (with π-delay matching) or 2x (without π-delay matching) DCS frames must be acquired for one distance calculation. Therefore, the resulting distance measurement rate turns out to be 39 fps or 79 fps respectively. For the grayscale mode the maximum frame rate of 158 fps is possible.

Symbol	Parameter	Min.	Typ.	Max.	Units
t <sub>DCLK</sub>	TCMI readout clock e.g. f <sub>DCLK</sub> = 48MHz		20.8		ns
t <sub>SHUTTER</sub>	Hold time for the signal on pin SHUTTER	250			ns
t <sub>SHUTTER_lag</sub>	Delay from the rising edge of SHUTTER signal to the 1 <sup>st</sup> LED pulse		18		µs
t <sub>INT</sub>	Image acquisition (integration time)		1		µs
t <sub>PROC</sub>	Delay from the last LED pulse until the 1 <sup>st</sup> row conversion		38.75		µs
t <sub>CONV</sub>	Conversion time for a pair of half rows (even or odd)		26.042		µs
t <sub>HSYNC</sub>	Readout time for a pair of rows e.g. f <sub>DCLK</sub> = 48MHz		13.33		µs
t <sub>HSYNC_lag</sub>	Delay from the begin of last readout until the 1 <sup>st</sup> LED pulse of next DCS frame		17		µs
t <sub>VSYNC_lag</sub>	Delay end of HSYNC to end of VSYNC at the end of each DCS frame		50		ns
t <sub>VSYNC</sub>	Data readout time for one DCS frame e.g. f <sub>DCLK</sub> = 48MHz t <sub>VSYNC</sub> = (2x t <sub>CONV</sub> x 119 rows) + t <sub>HSYNC</sub> + t <sub>VSYNC_lag</sub>		6'261		µs
	<b>Single measurement control mode:</b>				
t <sub>1st_FRAME_START</sub>	Delay from rising edge of SHUTTER signal until start of data readout of 1 <sup>st</sup> frame		83.79		µs
t <sub>1st_FRAME_TOTAL</sub>	Total time for reading one DCS or grayscale frame from rising edge of SHUTTER signal until end of readout of 1 <sup>st</sup> frame		6'345		µs
	<b>Continuous measurement control mode:</b>				
t <sub>FRAME_continuously</sub>	Total time for reading one DCS or grayscale frame t <sub>FRAME_continuously</sub> = (2x t <sub>CONV</sub> x 120 rows) + t <sub>HSYNC_lag</sub> + t <sub>INT</sub> + t <sub>PROC</sub>		6'307		µs
t <sub>4DCS_continuously</sub>	Total time for one 3D TOF distance measurement (4 DCS) t <sub>FRAME_continuously</sub> = ((2x t <sub>CONV</sub> x 120 rows) + t <sub>HSYNC_lag</sub> + t <sub>INT</sub> + t <sub>PROC</sub> ) x 4 DCS		25.23		ms

Table 17: Timings for one DCS or grayscale frames and for 3D TOF distance measurements (4x DCS)  
(Reference: see 28 and 29, f<sub>DCLK</sub> = 48MHz, t<sub>INT</sub> = 1µs)

Ref.	Imager settings (Input)			Imager output		
	Figure	Pixel-field mode	Binning hor., ver., both	Row reduction y-axis: 2, 4, 8	Resolution x-y [imager pixel]	DCS Frame rate [fps]
41	full resolution	no	1	320 x 240	158	150
41	full resolution	no	2	320 x 120	314	75
41	full resolution	no	4	320 x 60	617	38
41	full resolution	no	8	320 x 30	1'119	19
42	full resolution	horizontal	1	160 x 240	314	75
42	full resolution	horizontal	2	160 x 120	617	38
42	full resolution	horizontal	4	160 x 60	1'119	19
42	full resolution	horizontal	8	160 x 30	2'235	10
43	full resolution	vertical	2	320 x 120	314	75
43	full resolution	vertical	4	320 x 60	617	38
43	full resolution	vertical	8	320 x 30	1'119	19
44	full resolution	both	2	160 x 120	617	38
44	full resolution	both	4	160 x 60	1'119	19
44	full resolution	both	8	160 x 30	2'235	10
45	dual modes <sup>1</sup>	no <sup>2</sup>	1	2 x 320 x 120	158	150
45	dual modes <sup>1</sup>	no <sup>2</sup>	2	2 x 320 x 60	314	75
45	dual modes <sup>1</sup>	no <sup>2</sup>	4	2 x 320 x 30	617	38

Table 18: Frame rate and resolution for default ROI setting 320 x 120 pixel, top-left (4, 6) and bottom-right (323, 125)

Notes:

- <sup>1</sup> Frame rate and frame size are identical for dual phase and dual integration time mode (dual modes).
- <sup>2</sup> Binning cannot be used with dual phase and dual integration time mode.
- <sup>3</sup> Frame size is based on 2 Bytes per pixel to store in the application frame buffer.

### 6.5.2. Frame rate Half QQVGA 160x60 pixel

This example shows the ROI set symmetrically to 2 x 160 x 30 (Half-QQVGA) in the middle of the pixel-field: epc635 emulation. The frame time scales linearly with the reduced number of rows readout (see 19). The TCMI data-out time scales linearly with the reduced number of columns set in the ROI.

Note: The epc635 emulation is detailed in 34 and chapter 11.5.3

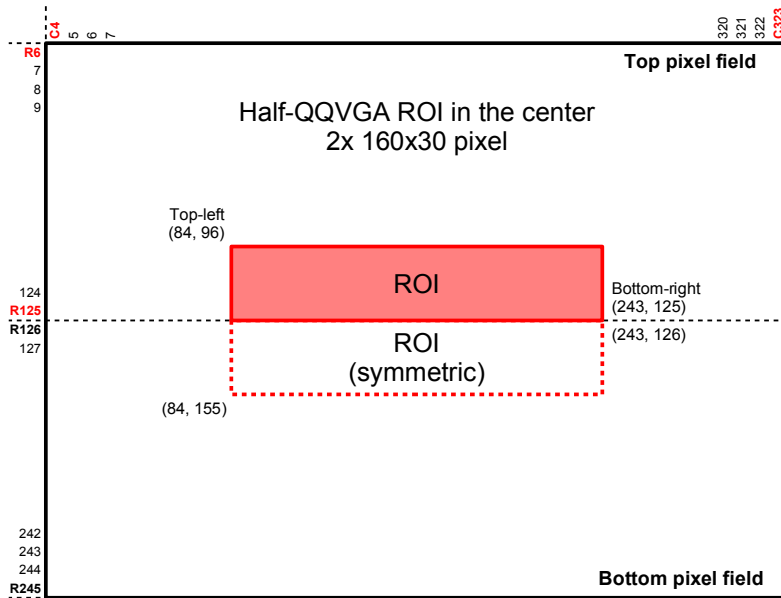

Figure 34: ROI for Half-QQVGA: 2 x 160 x 30 pixel

Ref.	Imager settings (Input)			Imager output		
Figure	Pixel-field mode	Binning hor., ver., both	Row reduction y-axis: 2, 4, 8	Resolution x-y [imager pixel]	DCS Frame rate [fps]	Frame size <sup>2</sup> [kbytes]
41	full resolution	no	1	160 x 60	617	19
41	full resolution	no	2	160 x 30	1'119	10
42	full resolution	horizontal	1	80 x 60	1'119	10
42	full resolution	horizontal	2	80 x 30	2'235	5
43	full resolution	vertical	2	160 x 30	1'119	10
44	full resolution	both	2	80 x 30	2'235	5
45	dual modes <sup>1</sup>	no <sup>1</sup>	1	2 x 160 x 30	617	19

Table 19: Frame rate and resolution for ROI setting: 160 x 30 pixel: top-left (84, 96) and bottom-right (243, 125)

Notes:

- <sup>1</sup> Binning cannot be used with dual phase and dual integration time mode.
- <sup>2</sup> Frame size is based on 2 Bytes per pixel to store in the application frame buffer.

### 6.5.3. Memory space estimation QVGA

Every frame (DCS) generates up to 320 x 240 pixel x 13 bit (Data + SAT) = 999 kBit. Stuffed to 16 bit words, the memory needed to store one DCS frame is 154kByte. Depending on the operation mode, up to 10 full frames or even more are needed. Thus, the minimum image memory RAM should be 1.5 MByte.

## 7. Pixel architecture

The pixels are placed in groups 2x2 pixels, called herein "pixel group". The pixel group performs two basic operations: Measurement (integration) and readout (ADC). Pixels are named as UE (Upper-row, Even-column), UO (Upper-row, Odd-column), LE (Lower-row, Even-column) and LO (Lower-row, Odd-column) depending on their location within the pixel group (see 35). Pixels with the same name are controlled simultaneously in the whole pixel-field. More precisely, pixels in the upper and lower rows are controlled simultaneously during measurement, pixels in the even and odd columns are controlled simultaneously during readout.

The pixel group architecture allows the epc660 to operate the pixel-field in different modes and in combinations thereof according to the following chapters.

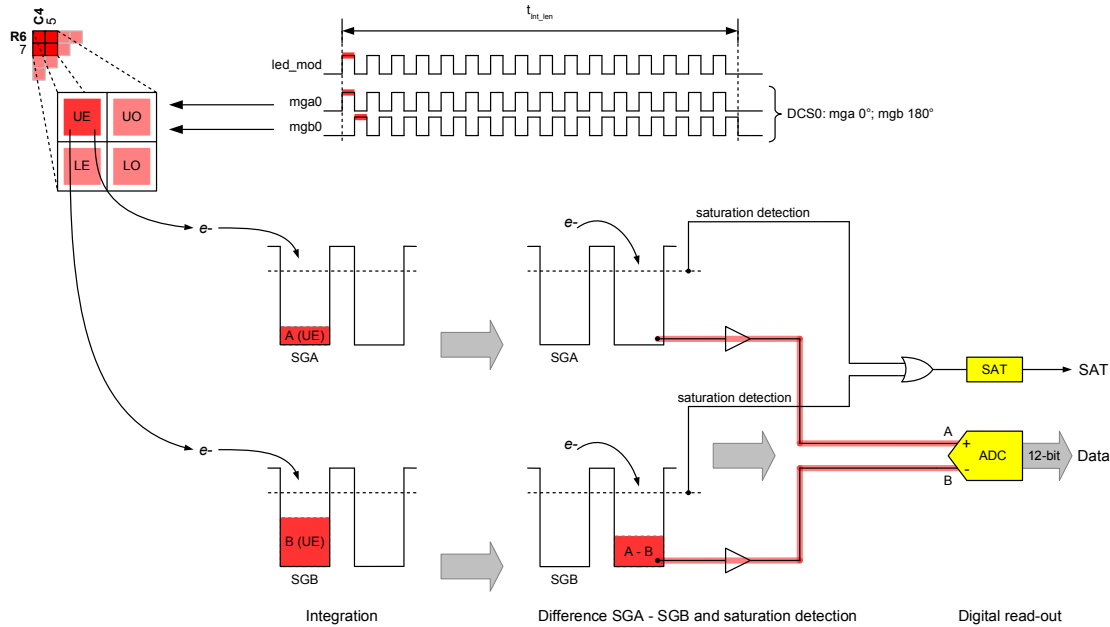

Figure 35: The 2x2 pixel group and the simplified function overview

Each pixel of the pixel group has its own pair of storage gates SGA and SGB. During the integration time, they accumulate the charges ( $e^-$ ) created by the reflected modulated light coming from the object (see section 9, Imaging). They are controlled by the mga and mgb demodulation signals. After the measurement is finished, the readout phase starts. The charges stored in the storage gates SGA and SGB are read out as a difference  $A - B$  (ambient-light suppression) and converted into a single 12-bit digital value and a 1 bit saturation flag. The output value can be either positive or negative depending on the demodulated phase and the offset of the signal chain.

## 8. Pixel-field and operation modes

### 8.1. Pixel coordinates

The epc660 pixel-field consists of a total of 328 x 252 pixels whereas 320 x 240 are active. 4 rows top/bottom and 6 columns left/right on the periphery of the pixel-field contain dummy pixels. The upper-left corner (top view on chip) is the origin (4/6) of the epc660 pixel-field. X-axis starts at 4 and counts up to 323 to the right. Pixel y-axis starts at 6 and counts up to 245 to the bottom. All readout modes and control registers use this coordinate system to set or change modes of the chip.

The pixel-field is split vertically into top and bottom. The data read-out is in parallel top and bottom to double the frame rate. It starts in the middle of the row axis. Thus the higher the row number the more dark current is collected by the pixels which appears like an increased DC offset of the pixel value (refer to chapter 1.4). The internal readout of a row is split in two sections: first all even pixels; second all odd pixels. Later on the TCMI interface presents the row in the regular order with even and odd pixels mixed.

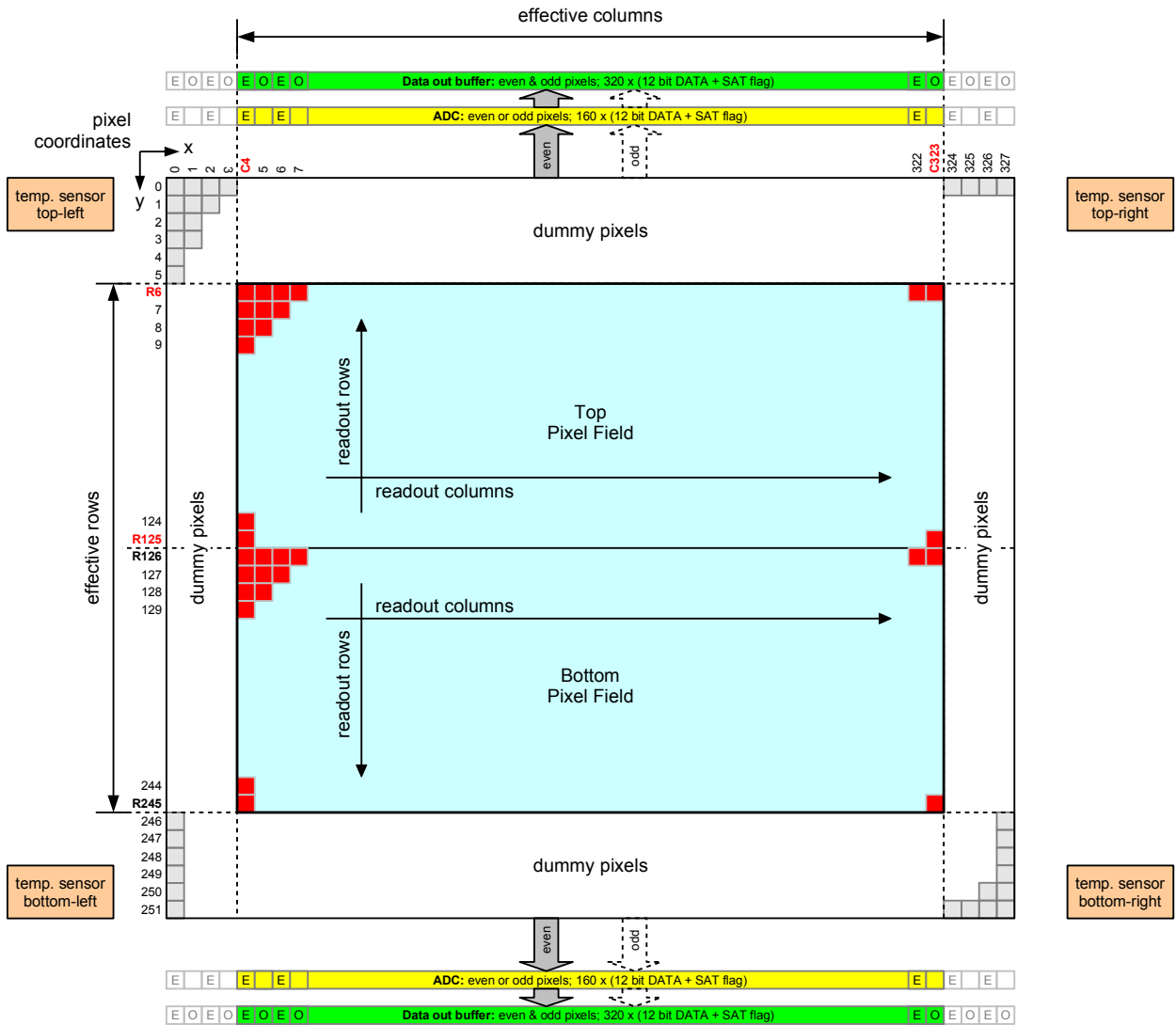

Figure 36: Pixel-field coordinates with row and column numbering scheme (top-view, solder balls are bottom side)

## 8.2. Operation modes

### 8.2.1. Full resolution mode (default)

This is the default operation mode for 3D TOF operation. All UE, UO, LE, LO storage gates work simultaneously during measurement operation. The storage gate control signals mga, mgb are applied to all pixels simultaneously (see 37). One, two or four DCS can be acquired in this mode.

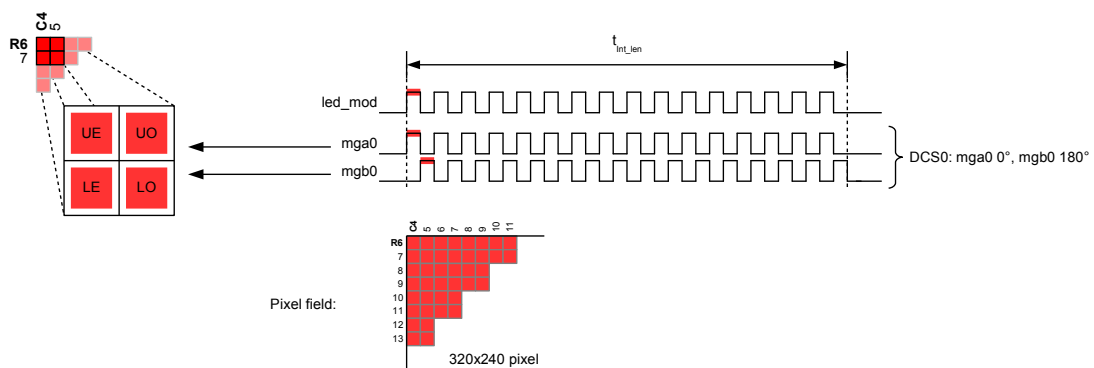

Figure 37: Full resolution mode: even and odd pixel rows are controlled identically with mgx0

### 8.2.2. Dual phase mode (motion blur reduction)

In this mode, the odd and the even rows are controlled by 90° phase shifted signals (see 38). This mode allows to acquire two 90° shifted DCSs at the same time, e.g. DCS0 and DCS1. In the two-DCS mode, distance calculation can be accomplished within one acquisition. Thus, motion blur is eliminated. The even row pixels store DCS0 (or DCS2) while the odd row pixels store DCS1 (or DCS3). The vertical



pixel pairs (e.g. UE/LE) must be treated for distance calculation as if they are one single pixel. This comes at the cost of a reduced resolution along the y-axis. The result provides a total of 320x240 pixel-field readout with an effective 3D TOF resolution of 240x120 pixel. Select this mode according chapter 11.4.1.

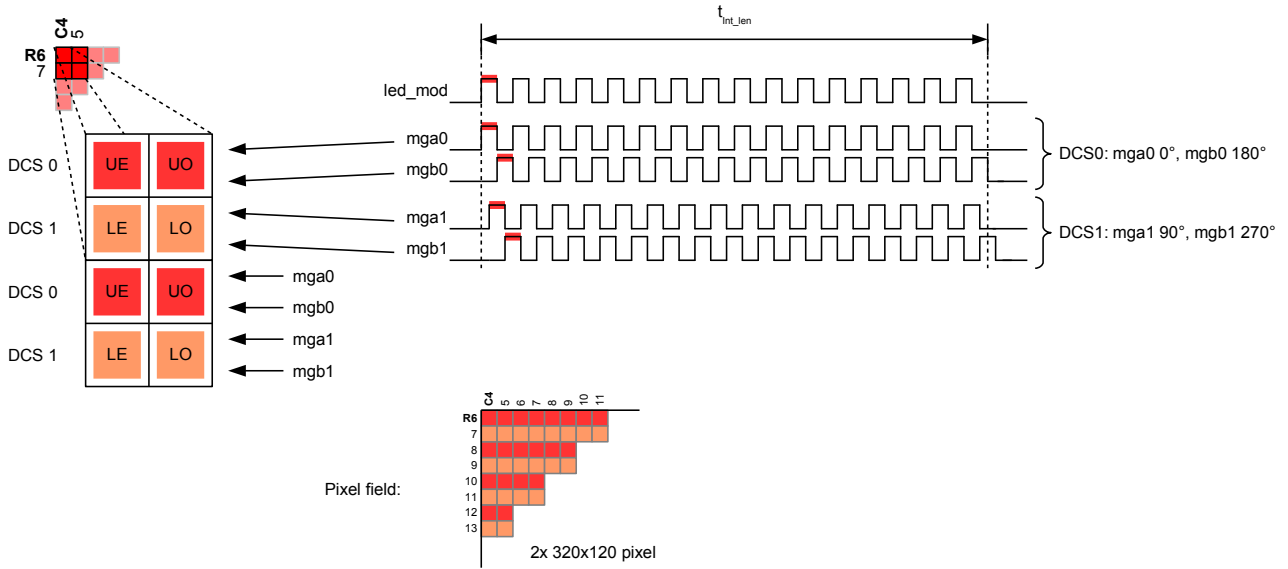

Figure 38: Dual phase mode with phase-shifted integration time: even and odd rows independently controlled by mgx0 and mgx1 with different phase shifts

**IMPORTANT:** This mode requires that adjacent pixels look to the same point on the target and receive the same amount of light. Otherwise, calculated distance values are not reliable. Pixel with a big offset or defective pixel will lead to completely wrong distance values with its paired pixel. Thus, the pixel group has to be discarded.

### 8.2.3. Dual integration time mode (high dynamic range, HDR mode)

In this mode, the odd and the even rows are controlled by different integration time lengths. It allows to acquire one image with two different integration times in order to increase the dynamic range. Both groups provide exactly the same DCS modulation signals (phases). One stops earlier than the other due to different integration times (see 39). As a consequence, the two pixels collect different amount of light simultaneously. There is no restriction about which integration time is shorter or longer with respect to the other. The even row pixels integrate with integration length 1, register 0xA2 and 0xA3 while the odd row pixels integrate with integration length 2, register 0x9E and 0x9F. The even and odd pixels (e.g. UE, LE) must be used independently for distance calculation. Finally, the vertical pixel pairs (e.g. UE/LE) must be treated as if they are one single pixel by using only the better of the two pixel signals. This comes at the cost of a reduced resolution along the y-axis. Instead of one frame with 320x240 pixels, a single readout provides two DCS or black and white frames with an effective resolution of 320x120 pixels but with different integration times.

Select this mode according chapter 11.4.2.

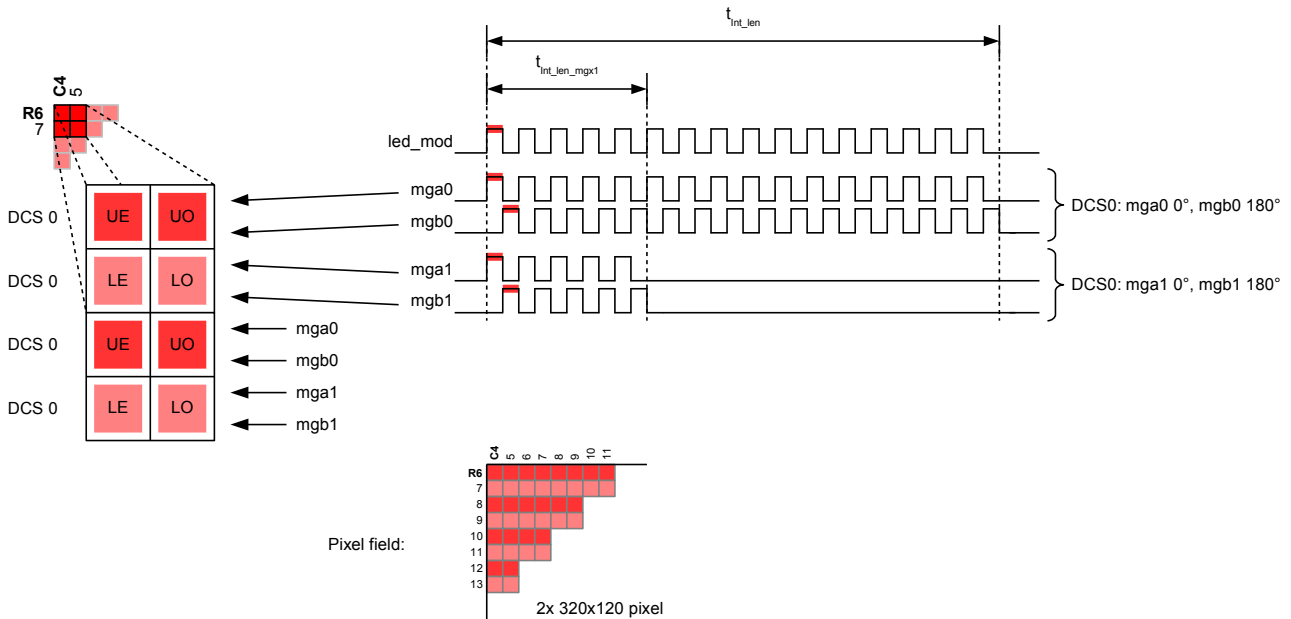

Figure 39: Dual integration time mode: even and odd rows independently controlled by mgx0 and mgx1. One stops earlier than the other.

### 8.2.4. Pixel binning

The charges accumulated in the storage gates during integration can be combined by binning: horizontal, vertical, horizontal+vertical (see 40). Advantages of binning are: higher sensitivity, reduced integration time and faster readout of frames.

**IMPORTANT:** Binning requires corresponding resolution reduction being enabled the same time. Refer to register 0x94. Binning cannot be used with dual phase and dual integration time mode.

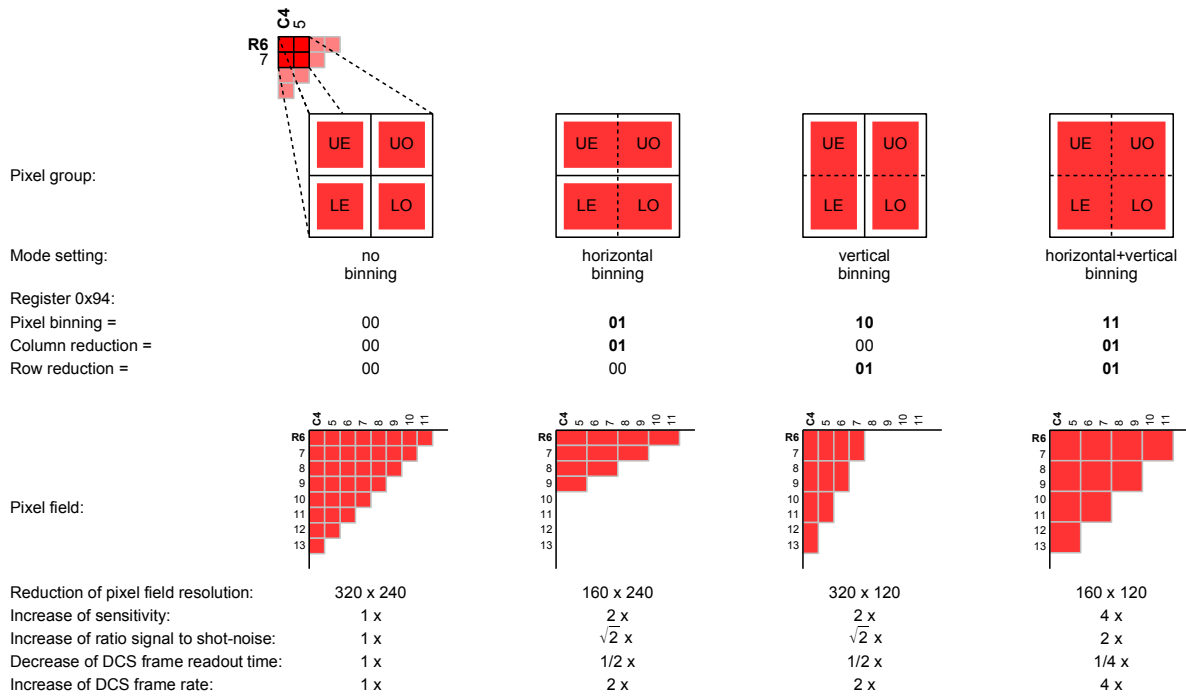

Figure 40: Pixel binning modes and readout

### 8.2.5. Resolution reduction

Resolution reductions by reading only every 2<sup>nd</sup> column on x-axis and every 2<sup>nd</sup>, 4<sup>th</sup> and 8<sup>th</sup> row on y-axis are supported independently. It can be combined with binning (see chapter before), ROI (see next chapter), motion blur reduction and high dynamic range modes. See 41 - 46 for example combinations.

**IMPORTANT:** Dual phase and dual integration time modes can be used with resolution reduction only, not with binning.

Resolution reduction shrinks the dataset to the necessary amount of data required for the application. The advantages are the reduced amount of data to be processed for the final measurement result (reduced frame buffers) and the faster processing (shorter readout and processing time).

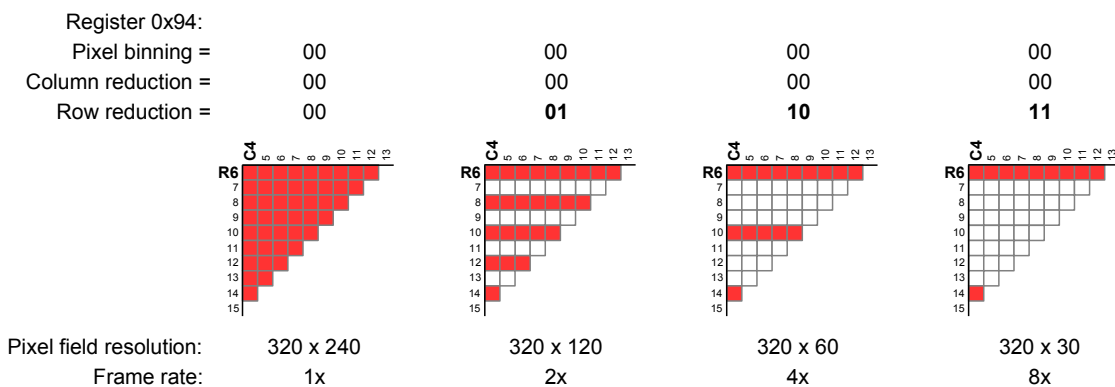

Figure 41: Row reduction on y-axis without binning

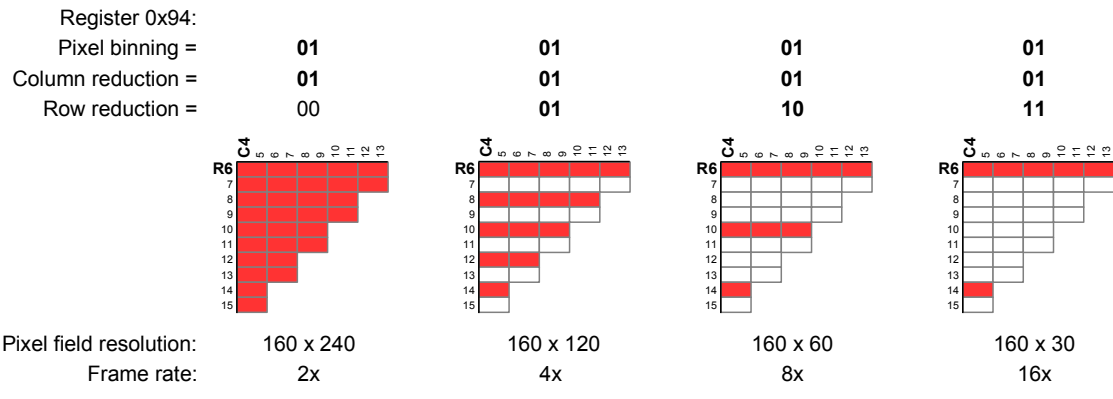

Figure 42: Row reduction on y-axis combined with horizontal binning

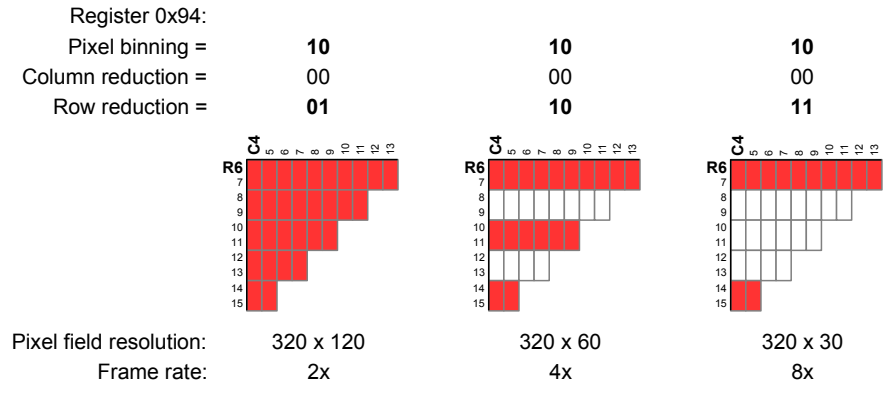

Figure 43: Row reduction on y-axis combined with vertical binning

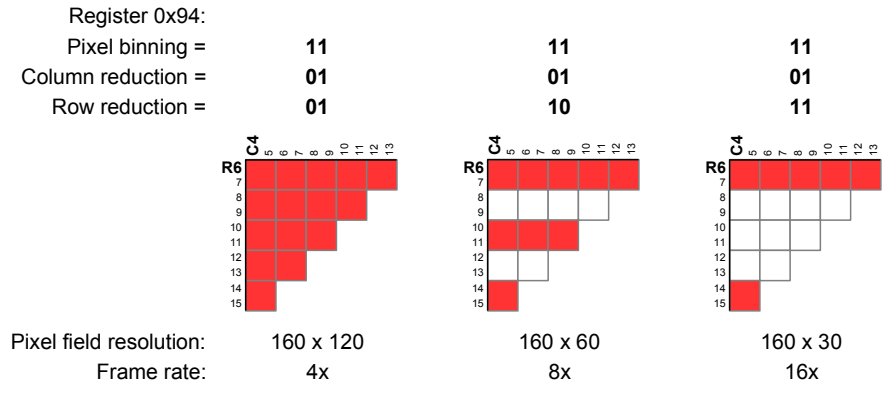

Figure 44: Row reduction on y-axis combined with horizontal and vertical binning

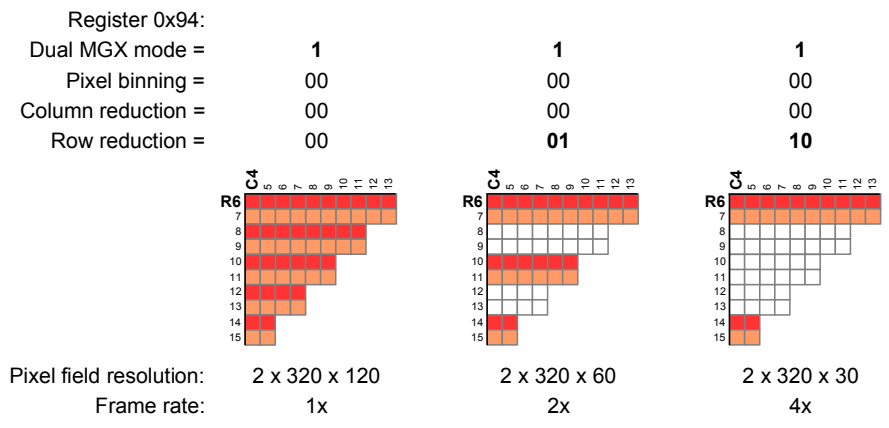

Figure 45: Row reduction on y-axis combined dual phase mode

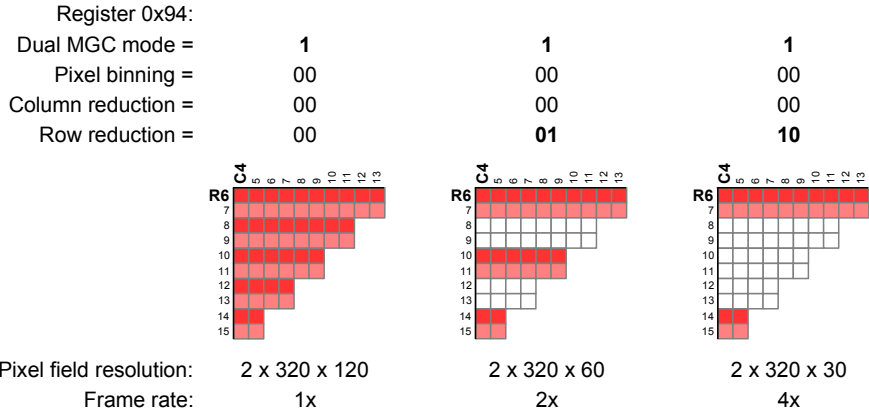

Figure 46: Row reduction on y-axis combined with dual integration time mode.

### 8.2.6. Region of interest (ROI)

The ROI allows readout and transfer the portion of the pixel-field data which is necessary for an application. The advantages are same as for the resolution reduction: Reduced amount of data which have to be readout and processed. For integration times in the  $\mu\text{s}$  range, much shorter than the row conversion time (see 28), the frame rate scales with the set number of rows of the ROI.

ROI is active always and works mirrored over the top and bottom pixel-fields. The symmetric part in the bottom pixel-field is generated simultaneously. Therefore, only minimum top-left [C4,R6] and the maximum bottom-right [C323,R125] coordinates in the top pixel-field need to be set (registers 0x96 – 0x9B). The ROI starts with even row and column and ends with odd row and column. Top-left coordinates are smaller than the bottom-right.

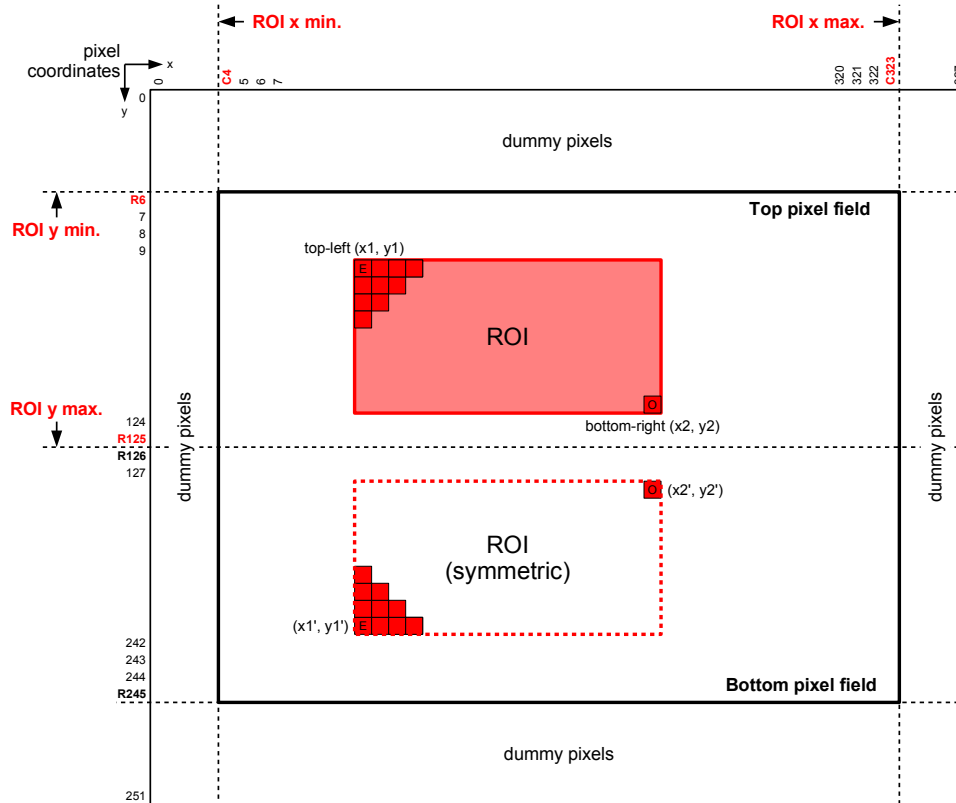

Figure 47: Region of interest (ROI)

The ROI registers can be changed on-the-fly via I<sup>2</sup>C all the time. The new values will be used with the next frame start. The application must use the same ROI during the data readout.

#### IMPORTANT:

1. ROI can be set to a minimum rectangle of columns by rows of 6 by 2.
2. If row reduction is enabled, the minimum number of ROI rows is inversely scaled, e.g.: **row reduction by 2** makes the minimum ROI to 6 by **4**.
3. If column reduction is enabled, the minimum number of ROI columns is inversely scaled, e.g.: **column reduction by 2** makes the minimum ROI to **12** by 2.

Note: The epc635 emulation is detailed in 34 and chapter 11.5.3

### 8.3. Pixel saturation detection

The pixels collect continuously modulated and non-modulated ambient light during the integration period. Depending on these light intensities, the pixels may collect more charge (over-exposure) than they can accommodate in their storage gates (refer to 35). In such a case, the 12 bit sample data is not valid and cannot be used for distance calculation.

#### 8.3.1. Hardware saturation flag

Each pixel generates a “saturation detection” flag along with the sample data, so that the data can be discarded by the application. The saturation flag is transmitted via XSYNC\_SAT pin with every pixel.

#### 8.3.2. Software saturation flag

If XSYNC\_SAT pin is used for an another function by setting register 0xCC, bit 6, bit 7 in register 0xCC enables to drive all DATA[11:0] to 0xFFF when the pixel is saturated.

## 9. Imaging

### 9.1. Distance measurement (3D TOF)

The epc660's default modulation mode is based on the sinusoidal TOF modulation theory but uses effectively for the illumination a square-wave modulated signal with a duty cycle of 50%. After reset, all internal register values are default to operate the chip at 4MHz XTAL/external clock input, multiplied up to 48MHz at the PLL output, clocks the modulator with 48MHz modulation clock (mod\_clk), modulates LED/LD with 12MHz and acquires 4 successive DCS frames (0 ... 3) using 47.6µs integration time.

The distance measurement mode uses the on chip LED driver and the external LED/LD to provide modulated light on the target. Modulation control signals to the LED driver are provided by a programmable modulator. The modulator generates all signals to modulate the external LED/LD and simultaneously all demodulation signals to the pixel-field. TOF and grayscale mode with all the variants are generated here.

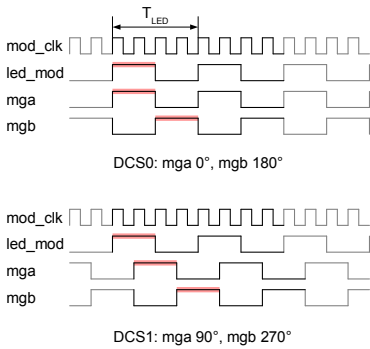

Figure 48: 4 DCS modulation/demodulation waveforms

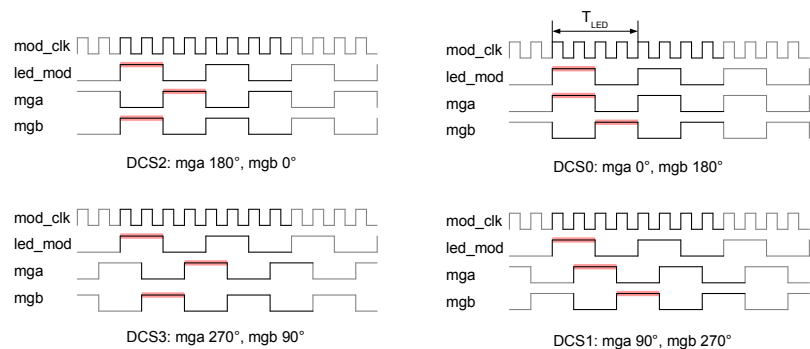

Figure 49: 2 DCS mod./demod. waveforms

The modulation table registers 0x22 ... 0x2D control the modulation (refer to 33). The registers can be updated via I<sup>2</sup>C bus between frame acquisitions. The application must take care that the last frame's integration phase is completed before modifying these registers on the fly. This time can be detected by the application by waiting for the falling-edge of VSYNC or the first falling-edge of HSYNC signal after shutter pulse/command was applied. This allows to run continuously at the maximum frame rate. For a full-frame readout, the margin is a 3.6ms to alter these registers via I<sup>2</sup>C on the fly.

With the application of the shutter pulse (HW SHUTTER or SW shutter via I<sup>2</sup>C), the chip performs the required number of successive DCS acquisitions. Each one of the 4 DCS frame types has a different phase relation between modulation (led\_mod) and demodulation (mga, mgb) signals which makes phase-to-distance calculation possible. In case of DCS0, led\_mod is phase-shifted by 0° and 180° with respect to mga and mgb, respectively. In case of DCS1, led\_mod is phase-shifted by 90° and 270°. For DCS2, the phase shifts are 180° and 0° and for DCS3, the phase shifts are 270° and 90° (see 48). Note that for DCS2 and DCS3, the demodulation signals mga and mgb are simply swapped with respect to DCS0 and DCS1, respectively.

By programming the number of DCS readouts = 01 (see 0x92 register), shutter initiates 2 successive DCS frame acquisitions (see 49). This mode allows distance acquisition by using two DCSs only and thus a doubled frame rate. However, the cost is a lower distance measurement accuracy and a 40% higher distance noise.

## 9.2. Distance calculation algorithm

The use of the trigonometric atan2 definition for vectors (x, y) in the Cartesian coordinate system  $\varphi = \text{atan2}(x, y) = \text{atan2}(y/x)$  guarantees a continuous distance calculation algorithm in the range of phases between  $-\pi \dots +\pi$ . In our case, we use the range from  $0^\circ \dots 360^\circ$  which corresponds to the distance from 0m up to the unambiguity distance (refer to 50 and 51).

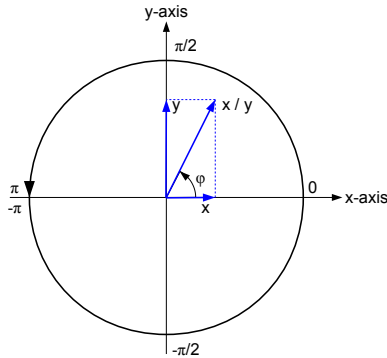

Figure 50: Continuous atan2 representation for the range  $-\pi \dots +\pi$

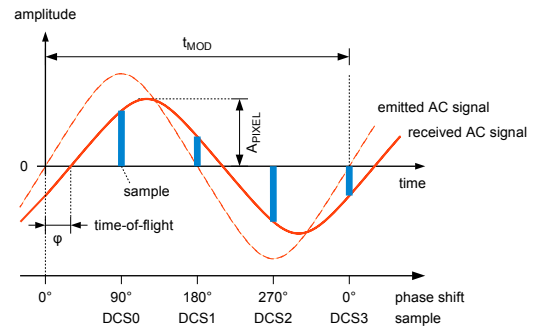

Figure 51: Sampling of the received waveform

Typically, the distance is calculated by using the 4 DCSs, also called  $\pi$ -delay matching, which cancels pixels offsets leading to distance errors:

$$[2] \quad D_{\text{TOF}} [\text{m}] = \frac{c}{2} \cdot \frac{1}{2\pi f_{\text{LED}}} \cdot \left[ \pi + \text{atan2} \left( \frac{\text{DCS3} - \text{DCS1}}{\text{DCS2} - \text{DCS0}} \right) \right] + D_{\text{OFFSET}}$$

The measured data are always over the  $360^\circ$  phase-shift valid. Due to the distance offset adjustment  $D_{\text{OFFSET}}$ , the correction of the distance roll-over effect at zero and unambiguity distance is necessary for having all the time correct distance values  $D$ :

- if  $D_{\text{TOF}} > D_{\text{Unambiguity}}$  :  $D = D_{\text{TOF}} - D_{\text{Unambiguity}}$
- if  $D_{\text{TOF}} < 0$ :  $D = D_{\text{TOF}} + D_{\text{Unambiguity}}$
- else:  $D = D_{\text{TOF}}$

If higher distance errors can be tolerated but a high frame rate is needed, the distance calculation also works with 2 DCSs only:

$$[3] \quad D_{\text{TOF}} [\text{m}] = \frac{c}{2} \cdot \frac{1}{2\pi f_{\text{LED}}} \cdot \left[ \pi + \text{atan2} \left( \frac{-\text{DCS1}}{-\text{DCS0}} \right) \right]$$

The following terms are used in the formulas above:

$D_{\text{TOF}}$	Distance in meters [m]
$c$	Speed of light 299'792'458 [m/s]
$f_{\text{LED}}$	LED/LD modulation frequency e.g. 12MHz
$\text{DCS0} - \text{DCS3}$	Sampling amplitude [LSB]
$\varphi$	Phase shift caused by the time-of-flight [rad]
$D_{\text{OFFSET}}$	Offset compensation [m]
$D_{\text{Unambiguity}}$	Unambiguity distance

### 9.2.1. Unambiguity range versus time base setting

Due to continuous modulation, roll-over can be observed if the distance to the object is longer than the length of one modulation cycle (one period,  $2\pi$ ). This roll-over distance is called unambiguity range can be calculated as follows:

$$[4] \quad D_{\text{Unambiguity}} [\text{m}] = \frac{c}{2} \cdot \frac{1}{f_{\text{LED}}}$$

The operating range is the maximum distance which corresponds to the maximum time-of-flight inside of one period of the used modulation: It is one period of  $f_{\text{LED}}$ . Objects inside this area are detected unambiguously.

The unambiguity range defines the repetition distance, where objects outside of the targeted operating range can still be detected as far they are of very high reflectivity (remission). Strongly reflected signals outside of this range may therefore interfere with the measurement.

The operating range, the unambiguity distance, the time base for the integration time and the resolution of the distance signal are defined by the modulation clock  $\text{mod\_clk}$ . This corresponds for the epc660 to a maximum default operating range of 12.5m @  $\text{mod\_clk} = 43\text{MHz}$ . It may be necessary depending on the application to adapt these parameters to other values. It can be done by a change of the modulation clock. 20 lists as an example some values of the modulation clocks in function of the the unambiguity distances, of the distance resolutions and of the multipliers of the integration time base.

Unambiguity distance	Integration time multiplied by	Distance resolution <sup>2</sup>	Modulation clock	Modulation clock divider	LED modulation frequency
			f <sub>MOD</sub>	Register 0x85	f <sub>LED</sub>
[m]	[#]	[cm]	[MHz]	[#]	[MHz]
6.25	1	0.21	96	0	24
12.5 <sup>1</sup>	2 <sup>1</sup>	0.42	48	1 <sup>1</sup>	12
25	4	0.83	24	3	6
50	8	1.67	12	7	3
100	16	3.33	6	15	1.5

Table 20: Unambiguity range versus on-chip modulation clock

Notes:

<sup>1</sup> Default values

<sup>2</sup> The distance resolution is given for an operating range corresponding to 3'000 LSB.

<sup>3</sup> Using external modulation clock MODCLK: Follow chapter 5.5.

### 9.2.2. Quality of the measurement result

The DCS values contain not only the distance information, but also the quality and the validity (confidence level) of the received optical signal. The higher the signal amplitude of the received signal, the better and more precise the distance measurement. Each distance measurement of every pixel has its own validity and quality.

The primary quality indicator for the measured distance data is the amplitude of the received modulated light A<sub>TOF</sub>. The amplitude is in direct relationship to the distance noise (refer to 5). The amplitude can be calculated as follows:

$$[5] \quad A_{TOF} = \frac{\sqrt{(DCS2 - DCS0)^2 + (DCS3 - DCS1)^2}}{2}$$

Amplitude A <sub>TOF</sub>	Classification	Action
< 25 LSB	Weak illumination	Objects can be detected but distance measurement is not possible. Increase the integration time for the next measurement.
25 ... 100 LSB	Useful for measurement	High distance noise, increase the integration time
100 ... 2'000 LSB	Good signal strength	No action necessary
> 2'000 LSB	Overexposed	Decrease integration time for the next measurement.

Table 21: Signal amplitude versus classification

Note:

The amplitude value is the feedback parameter that is used to set the integration time for the next measurement. Generally, the higher the received signal, the better and more precise the distance measurement. However, it is good practice to control the integration time such that an amplitude value between 200 ... 1'500 LSB is achieved. Higher values will only slow down the acquisition rate due to longer integration times, but are not significantly improving signal to noise ratio.

The quality indicator for the distance noise is the ratio of ambient-light E<sub>BW</sub> to the value of modulated light E<sub>TOF</sub> (AMR). This value may be calculated and used additionally to the above amplitude value if the respective application is subject to intense ambient-light. The irradiance E<sub>TOF</sub> of the modulated signal at the surface of a pixel can be calculated by the AC sensitivity S<sub>TOF</sub>, the used integration time t<sub>INT-TOF</sub>, the reference integration time t<sub>INT-REF-TOF</sub> and the amplitude A<sub>TOF</sub> of the received modulated signal the following way:

$$[6] \quad E_{TOF} = S_{TOF} \cdot \frac{t_{INT-REF-TOF}}{t_{INT-TOF}} \cdot A_{TOF} \quad \text{e.g.} \quad E_{TOF} = 0.60 \frac{\text{nW/mm}^2}{\text{LSB}} \cdot \frac{100 \mu\text{s}}{250 \mu\text{s}} \cdot 1'000 \text{ LSB} = 0.24 \mu\text{W/mm}^2$$

The formula to calculate the quality indicator "Ratio of ambient-light / modulated light" (AMR) is

$$[7] \quad \text{AMR[dB]} = 20 \cdot \log\left(\frac{E_{BW}}{E_{TOF}}\right) \quad \text{e.g.} \quad \text{AMR[dB]} = 20 \cdot \log\left(\frac{15.6 \mu\text{W/mm}^2}{0.24 \mu\text{W/mm}^2}\right) = 36\text{dB}$$

To obtain the E<sub>BW</sub> please refer to chapter 9.3 Grayscale imaging. This ratio is one of the influencing factors regarding the distance noise.

AMR value	Classification	Action
< 60 dB	excellent	No action necessary.
< 70 dB	sufficient	Is a lower noise level needed, do the next measurement with a shorter integration time or with an increased illumination power.
> 70 dB	weak	Do the next measurement with a shorter integration time or with an increased illumination power.

Table 22: Classification ratio ambient-light to modulated light (AMR) versus distance noise

There are also validity indicators delivered by the chip after a measurement. These will help to detect saturated or not illuminated pixels as a result of too much/less illumination or too long/short integration time.

23 shows a quality decision matrix as a summary of the validity and quality parameters for the distance measurement.

Step	Indicator	Pixel saturation: too much amb.-light or too bright illu.	Too bright illumination	No object detected	Too much ambient-light	Object detected
1	SAT flag	Set				
2	DCSx		> +99% or < -99%	all of them -1% ... +1%		
3	TOF amplitude		> 99%	< 1%		5% ... 99%
4	AMR: Ratio amb. to mod. light				> 70 dB	< 60 dB
5	Action	Decrease int. time	Decrease int. time	Increase int. time	Decrease int. time	Use distance data

Table 23: Validity (V) and quality (Q) decision matrix (see also 56)

### 9.3. Grayscale imaging

The grayscale mode allows using the epc660 as a grayscale imager. This mode can be used either without LED/LD illumination for ambient-light measurements or with LED/LD for active illumination of the scenery. The grayscale measurement uses regular DCS measurement but with DCS0 only. It is performed with differential readout using MGA only which stays on all the integration time. Data output format is signed integer 12 bit:  $\pm 2047$  LSB. Effective data range is 0 ... +2047. Due to system noise around zero, the readout can show small negative numbers. Corresponding settings can be found in register 0x3C (= 0x26). Due to fact that distance measurement results can be influenced by ambient-light, the grayscale measurement without illumination can thereof be used as an important quality and correction parameter for the distance measurement.

The saturation flag status is invalid in this mode.

The irradiance  $E_{BW}$  of the grayscale signal at the surface of a pixel can be calculated from the DC sensitivity  $S_{BW}$ , the used integration time  $t_{INT-BW}$ , the reference integration time  $t_{INT-REF-BW}$  and the amplitude of DCS0 of the grayscale signal as follows:

$$[8] \quad E_{BW} = S_{BW} \cdot \frac{t_{INT-REF-BW}}{t_{INT-BW}} \cdot DCS0 \quad \text{e.g.} \quad E_{BW} = 0.25 \frac{\text{nW/mm}^2}{\text{LSB}} \cdot \frac{100 \mu\text{s}}{1.6 \mu\text{s}} \cdot 1'000 \text{ LSB} = 15.6 \mu\text{W/mm}^2$$

### 9.4. Calibration and compensation of TOF cameras

This modern TOF sensor chip offers a fully digital interface to the control circuitry of a TOF camera. The first time, user naturally expects straight forward implementation and digital accuracy of the measured signals. Unfortunately, this is often followed by tremendous disillusion because of the many physical effects influencing the final performance of 3D TOF cameras.

3D TOF cameras capture images by utilizing the time-of-flight measurement of photons. Photons are emitted by high frequency modulated LEDs or laserdiodes, which are part of the camera, then scattered from objects in the scenery and finally, some of the emitted photons are reflected back to the camera and captured in so-called demodulation pixels. This time-of-flight happens in an incredibly short period of time as it takes place with 300'000km/s or 30cm/ns. If one would like to achieve a centimeter distance resolution and accuracy, 30ps time measurement accuracy has to be achieved. This is a very tough requirement, especially if tens of thousands of pixels shall provide such accurate measurement several dozen times per second at the same time. Small and inherent differences in the connection and arrangement of transistors within the TOF chip, temperature differences and changes, but also irradiance signal strength and last but not least ambient light change lead to measurement errors in the tens of centimeters:

Calibration and compensation is essential to reach the goal.

To support users, ESPROS issued on the Website [www.espros.com](http://www.espros.com) in the section "Downloads" the application note AN10 "Calibration and compensation of Cameras using ESPROS TOF Chips". This paper describes the error sources in 3D TOF sensor chips, a simple way to implement a calibration procedure and how to compensate them on camera level.

Other documents which can be helpful to achieve a successful implementation of the chip are listed in chapter 16.2, Related documents.

### 9.5. Noise reduction and signal filtering

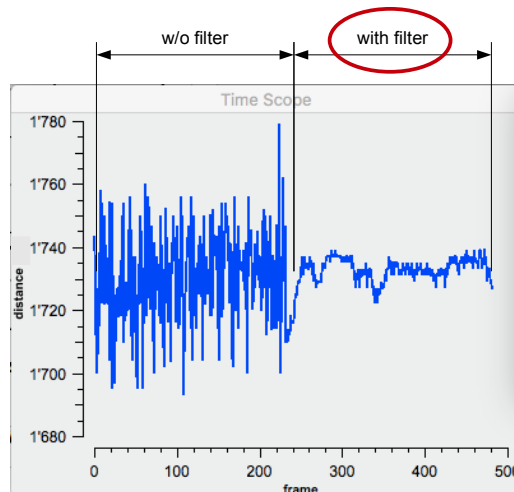

Figure 52: Effect of the static Kalman filter on distance noise (Distance in mm)



Whatever measurement process is applied, distance noise is one of the major challenging factors of 3D TOF imaging. It limits to distinguish in depth between small objects or fine contours. It is called temporal noise and varies from measurement to measurement. Since this noise is a statistical value, its effect can be reduced by filtering.

However, a simple averaging with a FIR filter is not suitable in many applications because of the very long time lag to get a filtered result. Filtering based on the theory of Rudolf E. Kalman, noise can be reduced significantly without losing responsivity of the system. 52 shows the resulting effect of such a Kalman filter.

Left side: The frames 0 to 120 have been acquired without filtering at all. The distance noise is approx. 12cmpp (1 sigma = 2.5cm).

Right side: Frames 121 to 250 are processed with the Kalman filter. The distance noise is reduced to approx. 2cmpp (1 sigma = 0.5cm).

The signal amplitude was quite low in both cases, approx. 250 LSB.

To support users, ESPROS issued on the Website [www.espros.com](http://www.espros.com) in the section "Downloads" the application note AN12 "Distance Noise Reduction with Kalman Filter". This paper describes background and implementation of two Kalman filter algorithms in 3D TOF cameras.

## 10. Temperature sensors

There are four temperature sensors located near the pixel-field (36). They are factory calibrated at 27°C (offset). The temperature values can be accessed in registers 0x60 - 0x67 after taking a grayscale image. The sensitivity for taking the grayscale image with the procedure described below is 2.5 times lower compared to the regular grayscale modes described in chapter 9.3. Most applications need grayscale (or ambient-light) pictures for background-light compensation. By reading the temperature, a grayscale image can be read at the same time.

### 10.1. Initialization

upon power-up or after a RESET:

```
define V, W, X, Y, M,           # Define required variables
    array_C[4], array_Z[4],     # Define required variables
    array_TH[4], array_TL[4],   # Define required variables, only for temperature reading
    Temp[4]                     # Define required variables

V = RD @0xD3                   # Save register 0xD3
W = RD @0xD5                   # Save register 0xD5
X = RD @0xDA                   # Save register 0xDA
Y = RD @0xDC                   # Save register 0xDC

array_C[0] = RD @0xE8          # Read sensor top-left factory calibration
array_C[1] = RD @0xEA          # Read sensor top-right factory calibration
array_C[2] = RD @0xEC          # Read sensor bottom-left factory calibration
array_C[3] = RD @0xEE          # Read sensor bottom-right factory calibration

# Calculate for i = 0,1,2,3
array_Z[i] = array_C[i]/4.7-0x12B # Normalized calibration values for the temperature formula

#Set defaults for grayscale
WR @0x3C = 0x26                # Ambient only (default factory setting)
WR @0x3A = 0x00                # Differential readout
```

Note:

The registers 0xD3, 0xD5, 0xDA, 0xDC are factory set registers (trim registers). To achieve an optimal temperature sensing, these registers have to be modified before temperature reading. Afterwards, their original contents have to be restored. This procedure is described above. If these registers are accidentally overwritten, the chip will not work anymore properly. However, the original content of these registers is stored in the EEPROM. By applying a reset, the original content is restored and the chip will work as expected.

### 10.2. Readout during runtime

1. Set the integration time for the grayscale image the regular way. Note: The sensitivity is 2.5 times lower than in the regular grayscale mode.
2. Acquire a grayscale image, do the temperature readout and the temperature calculation. The grayscale image will be acquired with the following procedure and stores the temperature value into the registers 0x60 ... 0x67.

```
M = RD @0x92                   # Save mode register, control no. of DCS

WR @0xD3 = V or 0x60           # Set bits b5 and b6
WR @0xD5 = W and 0x0F          # Clear bits b4 and b5
WR @0xDA = X or 0x60           # Set bits b5 and b6
WR @0xDC = Y and 0x0F          # Clear bits b4 and b5

# Image acquisition
WR @0x92 = 0xC4                # Change mode to grayscale
```

```

WR @0xA4 = 0x01          # Trigger image acquisition
                        # (can also be done with a hardware shutter pulse)

# Wait until the image is transferred (VSYNC goes high)
array_TH[0] = RD @0x60  # Read sensor top-left high byte
array_TL[0] = RD @0x61  # Read sensor top-left low byte
array_TH[1] = RD @0x62  # Read sensor top-right high byte
array_TL[1] = RD @0x63  # Read sensor top-right low byte
array_TH[2] = RD @0x64  # Read sensor bottom-left high byte
array_TL[2] = RD @0x65  # Read sensor bottom-left low byte
array_TH[3] = RD @0x66  # Read sensor bottom-right high byte
array_TL[3] = RD @0x67  # Read sensor bottom-right low byte

# Switch back to normal image acquisition
WR @0xD3 = V           # Restore register 0xD3
WR @0xD5 = W           # Restore register 0xD5
WR @0xDA = X           # Restore register 0xDA
WR @0xDC = Y           # Restore register 0xDC
WR @0x92 = M           # Change back to the mode before temperature reading

```

### 10.3. Calculate temperature in °C

```

#i = 0,1,2,3
Temp[i] = (array_TH[i]*0x0100+array_TL[i]-0x2000)*0.134+array_Z[i]

#Temp[0]: Sensor top-left temperature
#Temp[1]: Sensor top-right temperature
#Temp[2]: Sensor bottom-left temperature
#Temp[3]: Sensor bottom-right temperature

```

#### Note:

The grayscale image which has been acquired can be used. However, the sensitivity during this acquisition was reduced by a factor of 2.5. Thus, if the same sensitivity should be needed, the integration time has to be increased with a multiplier of 2.5.

In order to reduce temporal noise on the temperature measurement, the following filtering algorithm is recommended.

1. Spatial averaging over the 4 temperature sensors.
2. Temporal filtering with a Kalman filter.

```

x[i] = (Temp[0]+Temp[1]+Temp[2]+Temp[3])/4 # Spatial averaging

k = 0.1                                     # Kalman gain
y[i-1] = x[0]                               # Start condition

y[i]=k*x[i]+(1-k)*y[i-1]                   # Simple Kalman filter

```

x[i]: Current spatial averaged temperature  
y[i]: Current temporal filtered temperature  
y[i-1]: Previous temporal filtered temperature

# 11. Application information

## 11.1. Start-up and initialization sequence

1. Apply all positive supplies, while keeping  $\overline{\text{RESET}} = 0$ .
2. Wait until all positive supplies reach their rated levels.
3. Apply the  $V_{\text{BS}}$  negative supply, while keeping  $\overline{\text{RESET}} = 0$ .
4. Wait until  $V_{\text{BS}}$  reached its rated level.
5. Optional: Set/check the external 10kOhm pull-up resistors on the strap pins (HSYNC\_A1, VSYNC\_A0).
6. Release  $\overline{\text{RESET}} = 1$ .
7. Wait until the start-up/reset sequence is over ( $t_{\text{strap\_scan}} + t_{\text{EEPROM\_to\_CFG\_copy}}$ ).
8. Load the pixel sequencer code into the sequencer memory (refer to chapter 15.11)
9. Optional: Program the TCMI interface signal polarities with respect to the application CPU interface requirements via I<sup>2</sup>C interface.
10. Set register LED\_driver 0x90, bit 3 = 0, 0xAB = 0x00. Refer also to Chapter 1.6.
11. Register 0xAE: Set the value to 0x01.
12. Optional: Set LED/LED2 driver properties and polarities with respect to external LED/LD circuit on the PCB via I<sup>2</sup>C.

## 11.2. Image acquisition

1. Select the measurement mode: TOF or grayscale. Default: 4 DCS TOF mode.
2. Optional: Set ROI, registers 0x96 - 0x9B.
3. Set the integration time.
4. Start the frame acquisition by using shutter signal (shutter pulse/command).
5. Receive transmitted frames from TCMI interface to the external frame buffer on the application CPU.
6. Optional: Do a frame acquisition in grayscale mode according chapter 10 to acquire a grayscale image and read the temperature sensor registers 0x60 - 0x67.

Note: For corresponding I<sup>2</sup>C communication examples refer to chapter 13.4, I2C commands.

## 11.3. 3D TOF distance measurement flow

A final 3D TOF distance image will be done with different steps according to 53.

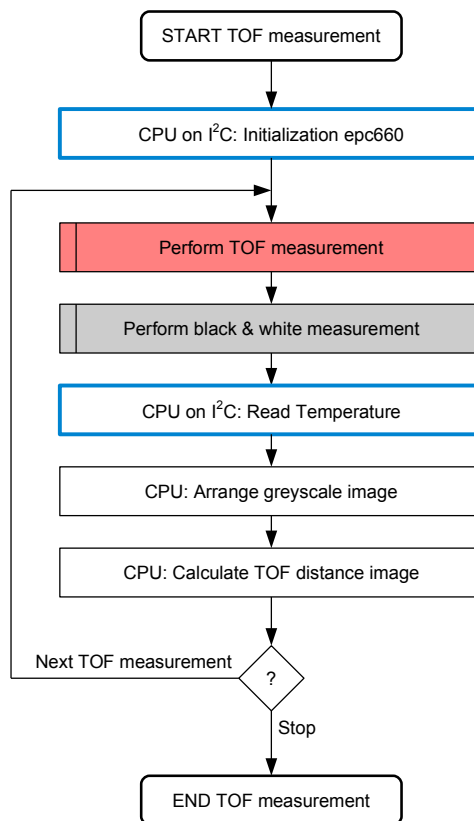

Figure 53: Generic 3D TOF distance measurement flow

Both interfaces of the epc660 are used: The I<sup>2</sup>C for configuration, mode selection and temperature reading (blue marked in the following figures) and the high-speed TCMI for reading the frame data (red marked in the following figures).The sequence starts with the initialization

of the epc660 registers with the necessary and correct configuration parameters. Next, the TOF measurement with the expected mode (4x DCS or 2x DCS) will be performed. Depending of the application and the ambient conditions (ambient-light, changing temperature conditions), the TOF measurement needs some compensation. For the purpose of more accurate ambient-light compensation, a grayscale measurement without illumination captures the background light level. Reading the on-chip temperature sensors (from time to time) helps to compensate thermal influences caused by e.g. the LEDs/LDs, the optical filters and the epc660 chip. After the rearrangement of the grayscale image to the correct pixel orientation, the final 3D TOF distance image can be calculated with all for the application necessary compensations.

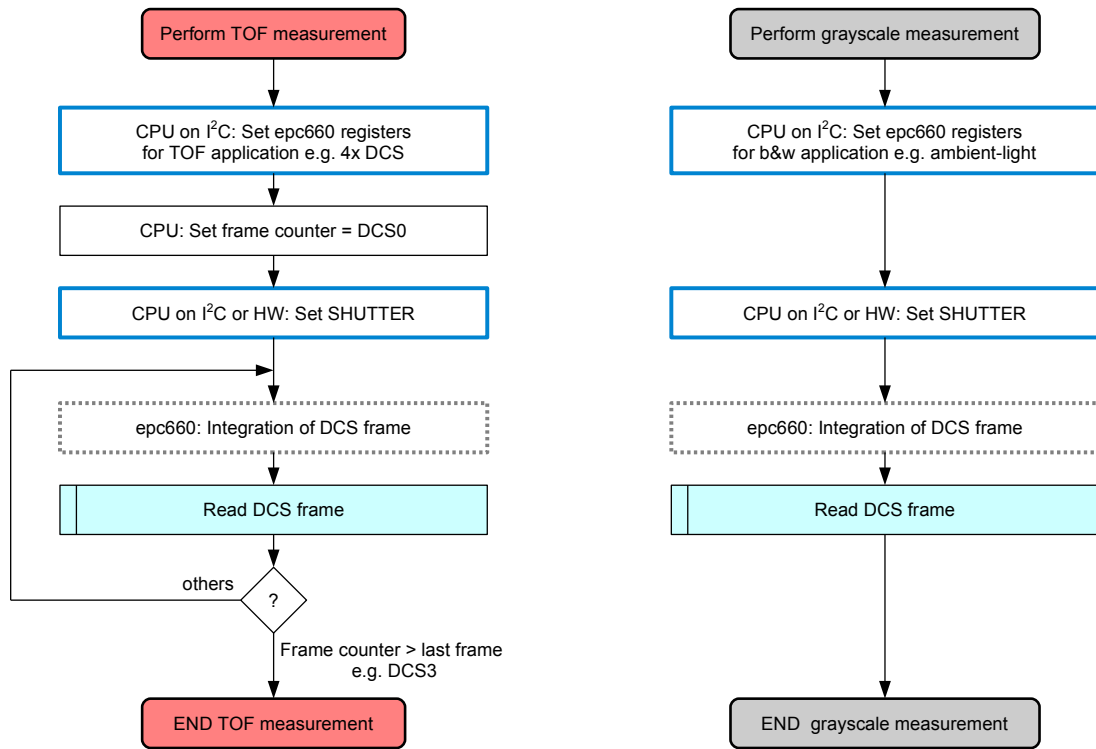

Figure 54: Generic sequences for the distance (TOF) and the grayscale measurement

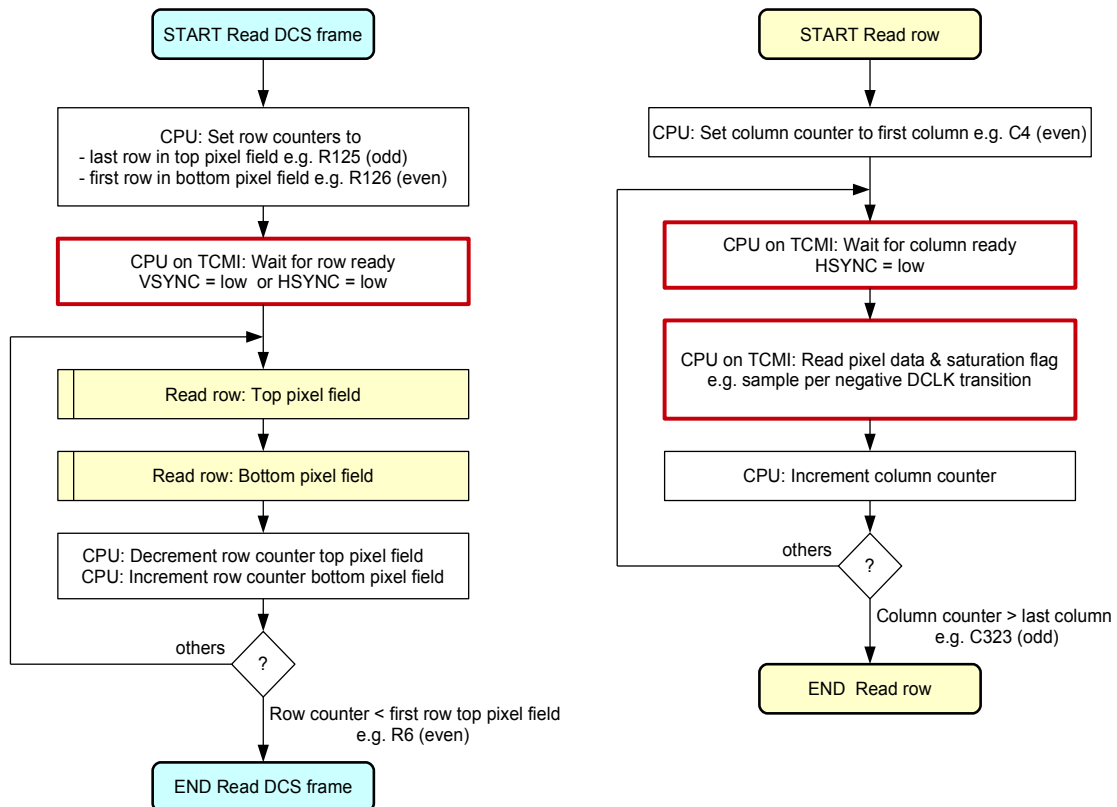

Figure 55: Generic sequences to readout frames and row by row

The process flows for distance measurements and for grayscale images are similar, see 54. The main differences are the mode selection (number of DCS or grayscale, see register 0x92) and depending thereof the number of frames, which need to be read out during a process cycle. After mode setting, the cycle will be started by applying the SHUTTER signal. Once the SHUTTER is stimulated, the epc660 executes the measurement until the end of the sequence automatically.

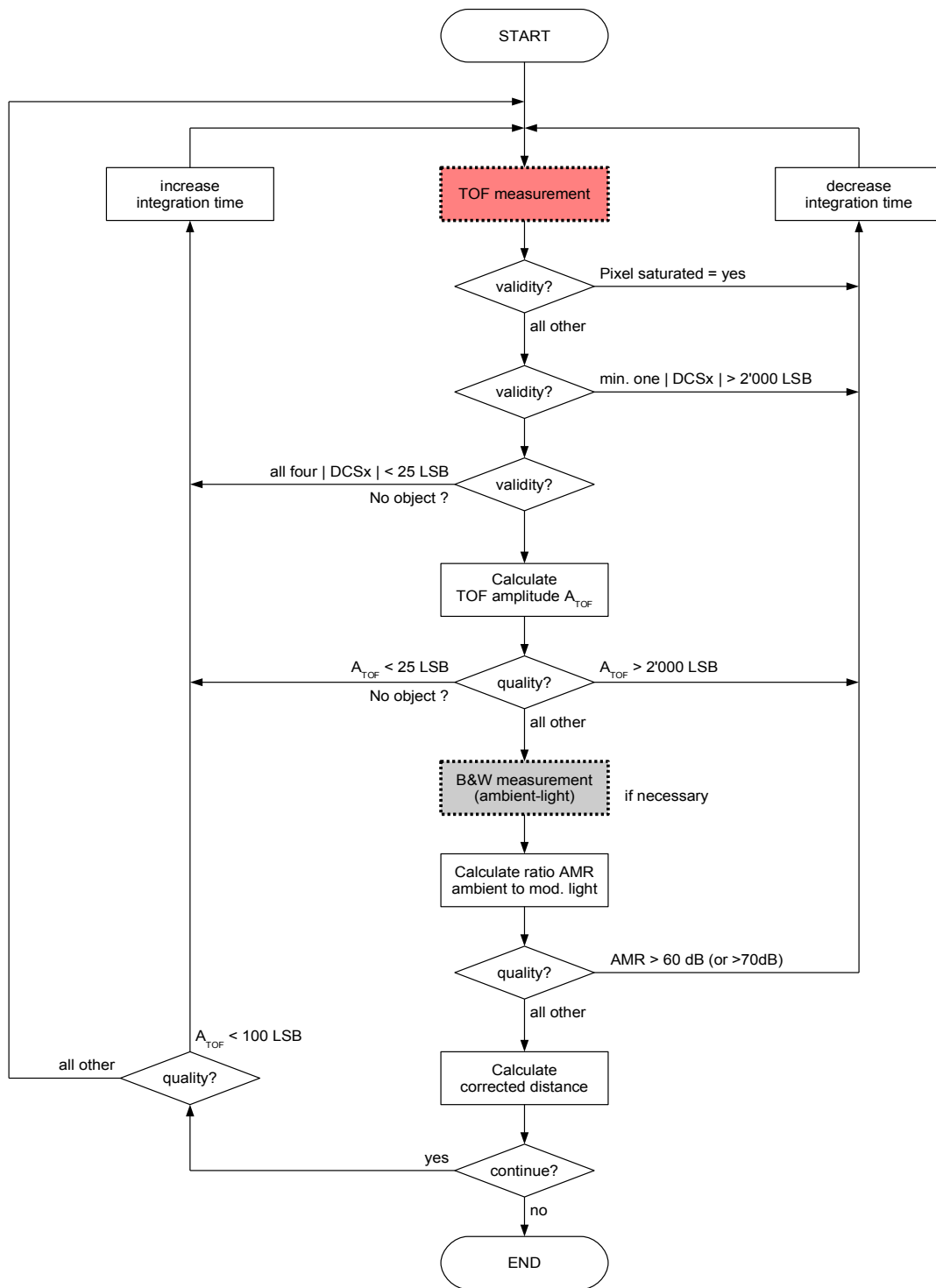

Figure 56: Generic validity and quality flow chart for a single pixel

The generic procedures to readout frames or rows are independently of the selected modes. The application is driven only by the TCMI interface during these phases. To catch the begin of the frame, the application CPU has to wait after the measurement start until the integration period is finished and the first frame data is available. The epc660 signals this by setting VSYNC and HSYNC active. Pixel data can be read DCLK by DCLK as long the HSYNC signal is active. Refer also to 28 and 30. The application has to take care to update synchronously all necessary frame, row and pixel readout counters during the measurement cycle.

#### 11.4. Integration time setting

The integration time is the active frame acquisition period (see 28). Specially for moving objects or cameras, this time should be as short as possible to reduce or eliminate motion blur effects. The integration time together with the illumination intensity also defines the effective achievable operating distance. Using the on-chip modulation clock, the integration time can be calculated as

$$[9] \quad t_{\text{INT}} = \frac{\text{reg}(0x85)+1}{96\text{MHz}} \cdot [\text{reg}(0xA2:0xA3)+1] \cdot \text{reg}(0xA0:0xA1)$$

24 lists some useful integration time settings.

Integration time	Registers (0xA0:0xA1)		Registers (0xA2:0xA3)	
	[DEC]	[HEX]	[DEC]	[HEX]
1.58 μs	1d	0x0001	75d	0x004B
12.5 μs	1d	0x0001	599d	0x0257
100 μs	1d	0x0001	4'799d	0x12BF
800 μs	1d	0x0001	38'399d	0x95FF
1.6 ms	2d	0x0002	38'399d	0x95FF

Table 24: Typical TOF and grayscale integration times for 12MHz on-chip modulation frequency (modulation clock = 48MHz)

#### 11.5. Special mode setting

In this chapter, the user will find the register setting tables for using the special dual modes. Detailed descriptions are given in the corresponding chapters of these modes; see chapter 8, Pixel-field and operation modes.

##### 11.5.1. Dual phase mode selection (motion blur reduction)

Refer for the description to chapter 8.2.2.

- This mode needs the following basic setting of the register 0x94 = 0x80, register 0x22 = 0x34 and register 0x25 = 0x3E.
- Reset the registers to the default values after leaving this mode: register 0x94 = 0x00, register 0x22 = 0x30 and register 0x25 = 0x35.

Function	Register 0x92	Comments
4x DCS	not applicable	
2x DCS <sup>2</sup>	0x14	Output is effectively 4x DCS in 2 DCS-frames.
Grayscale	not applicable	

Table 25: Setting basic dual phase mode

##### 11.5.2. Dual integration time mode selection (high dynamic range)

Refer for the description to chapter 8.2.3.

- This mode needs the following basic setting of the register 0x94 = 0x80.
- Reset the register to the default value after leaving this mode: register 0x94 = 0x00.
- Output is 2 equal DCS frames with different integration times in one readout frame.

Mode	Register setting		Comments
	Register 0x92	Register 0x3C	
4x DCS	0x3C	0x26	
2x DCS	0x1C	0x26	
Ambient only	0xCC	0x26	Grayscale imaging, no active illumination
Ambient & non modulated LED/LD	0xCC	0x16	Grayscale with DC illumination
Ambient & modulated LED/LD	0xCC	0x06	Grayscale with modulated illumination

Table 26: Setting dual integration time mode for TOF and grayscale

##### 11.5.3. epc635 emulation

epc660 can emulate the epc635 (160x60 pixel) in terms of frame rate, resolution and data transfer by reprogramming the chip.

57 and 58 show the mechanical and optical compatibilities between both chip types.

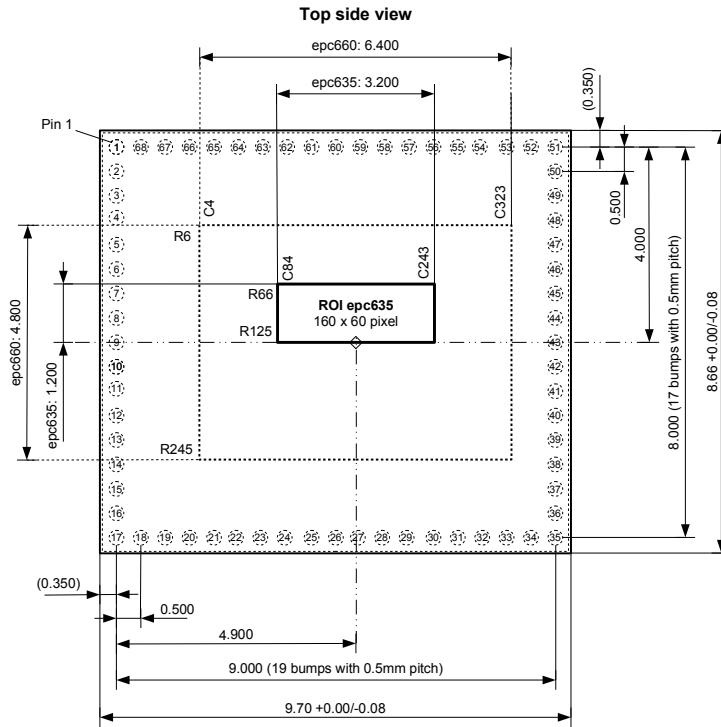

Figure 57: epc660: ROI setting for epc635 emulation

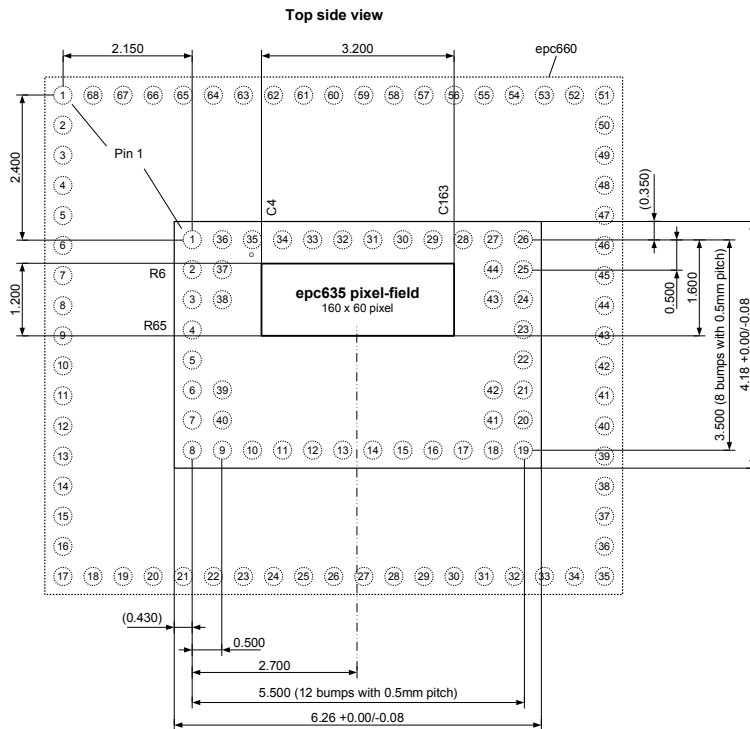

Figure 58: Mechanical dimensions epc635 versus epc660, pin 1

**Change to and use of the epc635 mode:**

1. Start up the epc660 chip.
2. Wait until the chip is in READY state.
3. Download by I<sup>2</sup>C the program segments for reprogramming the epc660 to get epc635 emulation mode. The download sequence is part of the download package for the epc660 Evaluation Kit.
4. The chip is now ready to be used as epc635:

The chip uses the regular instructions epc660 except the ROI which is limited to the upper half pixel-field. For frame rates, refer to 19. **IMPORTANT:** epc635 mode is reading out the upper part of the pixel-field only: Data readout starts at the last row (125) and proceeds in continuous way upwards until the first row (66). There is no swap between upper and lower pixel-field rows. The ROI setting is according to 27. Readout has to follow the effective numbers and order of columns and rows.

5. Exit epc635 mode: Power down or RESET sets the chip back into the epc660 mode.

Ref.	Imager		ROI setting	Register setting top left		Register setting bottom right	
Figure	Type	Resolution x-y	Resolution x-y	X (0x96/0x97)	Y (0x9A)	X (0x98/0x99)	Y (0x9B)
		[imager pixel]	[imager pixel]	[DEC]	[DEC]	[DEC]	[DEC]
47	epc660: QVGA	320 x 240	320 x 120	4	6	323	125
34	epc635: Half-QQVGA	160 x 60	160 x 60	84	66	243	125

Table 27: Asymmetric ROI setting for epc635 emulation (refer to item 4, **IMPORTANT**)

### 11.6. Power consumption

The epc660 has several power states/levels during the different operation phases which are shown in 28 and 59.

Power state	Power [mW]	Operation description
RESET	54	All supplies are ON, $\overline{\text{RESET}} = 0$ , Oscillator is ON, PLL and all system system clocks are OFF
READY	110	$\overline{\text{RESET}} = 1$ , PLL and all system clocks ON, waiting for SHUTTER
INTEGRATION	1'300	SHUTTER pulse/command
CONVERSION	580	Integration finished, conversion of rows
CONVERSION + DATAOUT	555	Transmit row data via TCMI while converting next row
DATAOUT	110	Transmit last row data via TCMI

Table 28: Typical average power consumption levels at different operating states (integration time < 5ms)

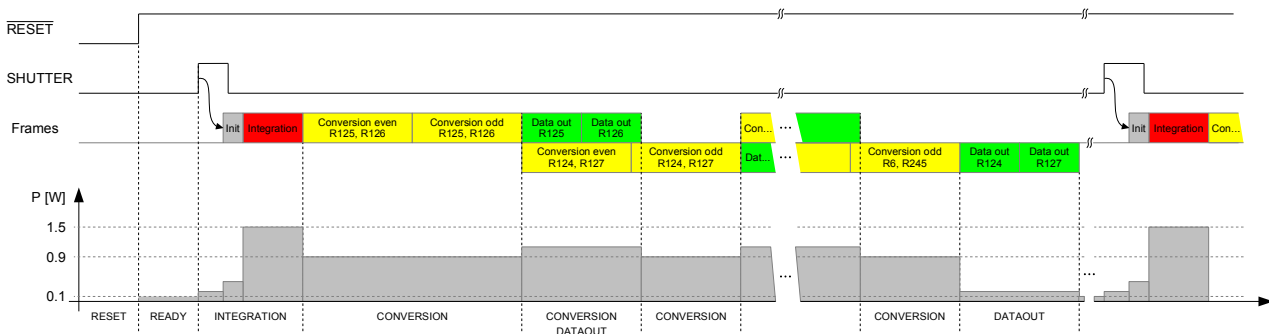

Figure 59: Power consumption levels and operating states

For power critical applications e.g. battery powered systems, it is possible to enforce the epc660 to go in so-called power saving states.

No.	Register			Description
	Name	Address	Value	
<b>Power down</b>				
1	Power control	0xA5	0x00	Switch off of unnecessary supplies
2	Clock control	0x80	0x00	Switch off of unnecessary clocks
3	Mode control	0x7D	0x14	Switch system clock to XTAL clock
4	Mode control	0x7D	0x10	Switch off PLL
<b>Power up</b>				
5	Mode control	0x7D	0x14	Switch on PLL
5	<b>Wait &gt; 32µs</b>			<b>Wait until PLL stable</b>
7	Mode control	0x7D	0x04	Switch system clock to PLL
8	Clock control	0x80	0x3F	Switch on the clocks again
9	Power control	0xA5	0x07	Switch on the supplies again
10	<b>Wait until supplies are stable</b>			
11	<b>Regular 3D TOF operation</b>			

Table 29: Sequence for the SW POWER DOWN mode



### 11.7. Rolling DCS frames

In special applications, it is possible to use all the time the same integration time in continuous distance measurement mode without any grayscale images for ambient-light compensation. Such a set-up allows enhancing the distance measurement rate by a factor of 4 by using rolling DCS frames.

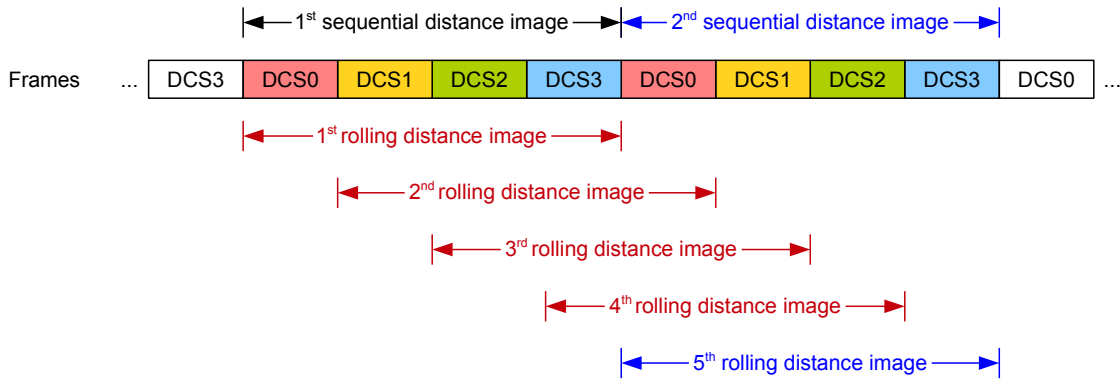

Figure 60: Rolling DCS frames

As shown in 60, the algorithm performs with each new DCS frame a new distance calculation based on the new and last three DCS frames.

### 11.8. Enhanced rolling DCS frame mode

epc660 allows to set for each single DCS access own parameters. This opens also the possibility to acquire in time-sequence DCSx frames with e.g. different integration times.

The enhanced rolling mode combines all:

The stacking of integration times to enlarge the dynamic range, the acquisition of an ambient-light image for correction and the rolling mode to speed up the frame rate.

The final distance frame acquisition will be in an equidistant time manner e.g. for 2 or more different integration times.

Select out of the acquired integration time distance frames, already compensated, each time the most reliable distance information for the final composed distance picture

The example shown here is using two integration times:

50µs for detecting short range objects and 2ms doing the same for the long range.

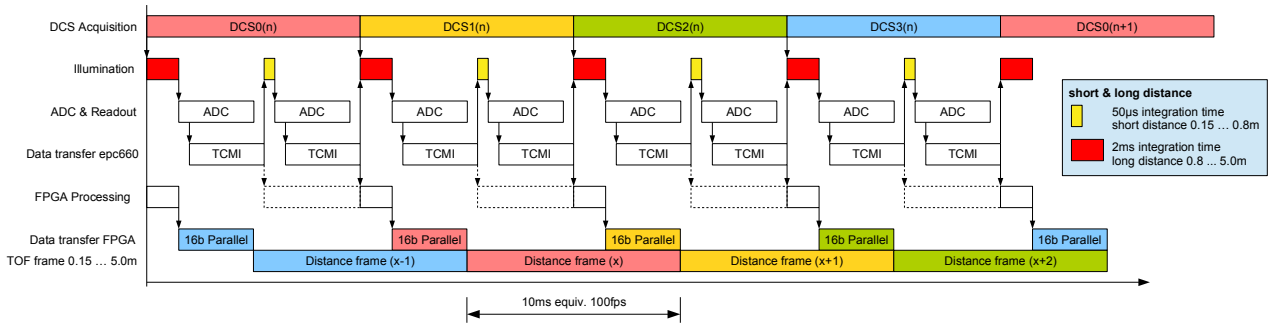

Figure 61: Enhanced rolling mode sequence

Implementation example step by step: Rolling mode using 3 integration times

1. Chose single frame mode by setting register 0x22 and 0x92.
2. Run 4 DCS turns by
3. Select DCS0 and acquire 3 DCS0 each with one of the 3 integration times  
 Integration time t1 > shutter > readout > integration time t2 > shutter > readout > integration time t3 > shutter > readout.  
 2<sup>nd</sup> and following turns:  
 Calculate for each integration time the distance and TOF amplitude image with the last 4 corresponding DCS frames.  
 Select out of the acquired integration time distance images, already compensated, each time the most reliable distance information and compose the actual final distance picture.
4. Select DCS1 and acquire 3 DCS1 each with one of the 3 integration times  
 Integration time t1 > shutter > readout > integration time t2 > shutter > readout > integration time t3 > shutter > readout  
 2<sup>nd</sup> and following turns:  
 Calculate for each integration time the distance and TOF amplitude image with the last 4 corresponding DCS frames.

Select out of the acquired integration time distance images, already compensated, each time the most reliable distance information and compose the actual final distance picture.

... and so on ...

	Register	0x22	0x25	0x92
Mode	DCS/Shutter	DCS select 1 <sup>st</sup> frame	DCS select 2 <sup>nd</sup> frame	Modulation select
4 DCS	DCS 0, 1, 2, 3	0x34	0x3D	0x30
2 DCS	DCS 0, 1	0x34	0x3D	0x10
	DCS 2, 3	0x32	0x33	
1 DCS rolling	DCS 0	0x34	Not used	0x00
	DCS 1	0x31		
	DCS 2	0x32		
	DCS 3	0x33		

Table 30: DCS selection for enhanced rolling mode

## 12. Parameter and configuration memory

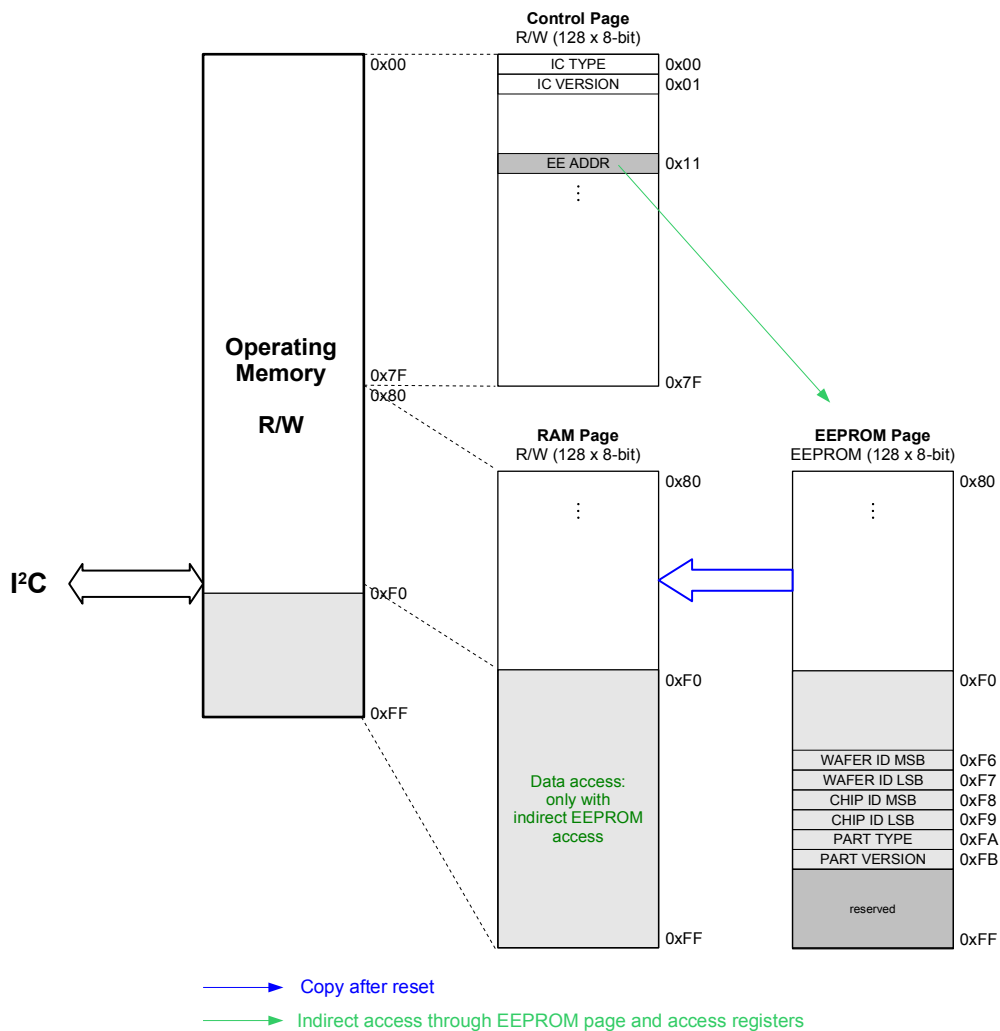

Figure 62: Memory map

### 12.1. Data memory map

The epc660 control registers (RAM) are used for controlling all features of the chip. They are organized as 256x8 bit into 0x00 ... 0xFF address locations. The address space 0x80 ... 0xFF is EEPROM backed-up. EEPROM parameters in this section are stored permanently between the power off/on cycles. All registers can be accessed through I<sup>2</sup>C interface by the application CPU (see chapter 13, I<sup>2</sup>C interface). Multiple byte registers are stored in the order MSB first, then LSB.

### 12.1.1. Control page

The control page contains R/W accessible registers with default values during startup. The content can be changed via the I<sup>2</sup>C interface. The changed values are preserved as long as the IC is powered. They are set back to their default values with a reset.

### 12.1.2. RAM page

The RAM page contains R/W accessible registers with EEPROM copied values after startup. The content can be changed via the I<sup>2</sup>C interface. The changed values are preserved as long as the IC is powered. They are set back to EEPROM values with a reset.

### 12.1.3. EEPROM page

The embedded 128x8-bit EEPROM stores operation parameters as well as factory set trimming and calibration values.

## 13. I<sup>2</sup>C interface

The I<sup>2</sup>C-bus interface allows accessing the RW registers and the programming of the EEPROM registers which store the configuration parameters. It is the only interface through which the configuration registers can be accessed (62 and 33) by the application. It works as a slave device according to the I<sup>2</sup>C specification (refer to chapter 16.2) with a transfer rate of up to 400 kbit/s in Fast Mode (FM) or 1Mbit/s in Fast Mode plus (FM+). The I<sup>2</sup>C master such as an external CPU can set the transfer speed simply by driving the SCL input at that frequency (up to 1MHz), therefore there is no prior register configuration or setting necessary.

I<sup>2</sup>C specification is supported in epc660 with following remarks/exceptions:

- 7-bit addressing only is supported.
- Clock stretching is supported.
- General call address: By transmitting 0x00 followed by 0x06 (issues software reset) or transmitting 0x00 followed by 0x04 (device address reload), the programmable part (A0, A1) of the I<sup>2</sup>C address pins is overwritten by the initially scanned value through strap pins during start-up or reset phase.
- Software reset is supported.
- Other uses of I<sup>2</sup>C bus are not supported.

### 13.1. Device addressing

The epc660 7-bit I<sup>2</sup>C device address is hard-wired to the value shown below in 63. Two address bits A0, A1 can be optionally initialized as 1 through strap pins (chapter 5.6.3). In a typical single-camera 3D TOF imager application in which epc660 is directly connected as a single I<sup>2</sup>C slave to a single I<sup>2</sup>C master, the strap pins can be left open. An internal pull down resistor keeps them low. In this case, the device address is set after reset default as 010000. In a multi-camera application with up to 4 epc660 devices connected on the same I<sup>2</sup>C bus as slaves or together with other I<sup>2</sup>C slaves talking to a single I<sup>2</sup>C master, external pull-up resistors can be utilized on the strap pins to initialize different I<sup>2</sup>C device addresses in order to correctly identify different epc660 slaves on the bus.

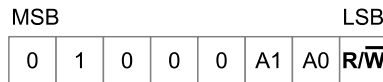

Figure 63: Device address through I<sup>2</sup>C

### 13.2. I<sup>2</sup>C bus protocol notation

The following notation is used:

- S      **S**TART condition
- P      **S**TOP condition
- A      **A**cknowledge last byte (ACK)
- $\bar{A}$     **N**ot-Acknowledge last byte (NACK)
- Shaded part of protocol: transmitted by master
- Unshaded part of protocol: transmitted by epc660

### 13.3. I<sup>2</sup>C bus timing

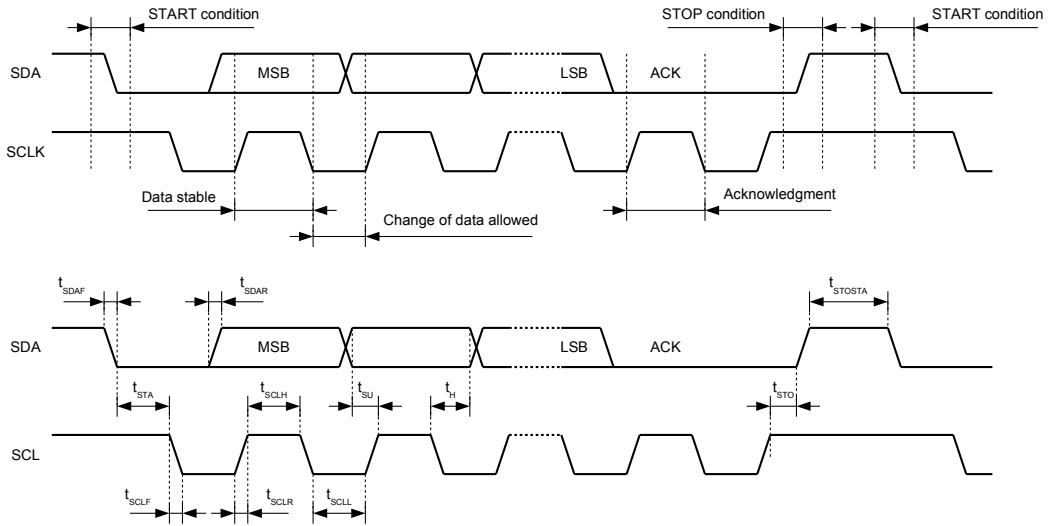

Figure 64: I<sup>2</sup>C bus timing

Symbol	Parameter	Min.	Max.	Units
$t_{SCLL}$	SCL clock low time	0.5		$\mu$ s
$t_{SCLH}$	SCL clock high time	0.26		$\mu$ s
$t_{SU}$	SDA setup time	50		ns
$t_H$	SDA hold time		0	ns
$t_{SDAR} / t_{SCLR}$	SDA and SCL rise time		120	ns
$t_{SDAF} / t_{SCLF}$	SDA and SCL fall time		120	ns
$t_{STA}$	Start condition hold time	0.26		$\mu$ s
$t_{STO}$	Stop condition setup time	0.26		$\mu$ s
$t_{STOSTA}$	Stop to start condition time (bus free)	0.5		$\mu$ s
$C_b$	Capacitive load for each bus line		550	pF
$t_{SP}$	Pulse width of the spikes that are suppressed by the analog filter		50	ns

Table 31: I<sup>2</sup>C bus timing: Timing parameters (FM+)

### 13.4. I<sup>2</sup>C commands

#### 13.4.1. Software reset

(0x00, 0x06) issues a software reset, same behavior like hardware reset.

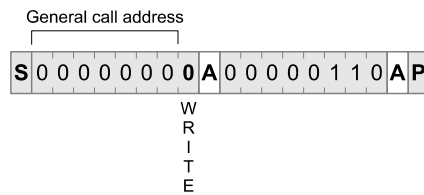

Figure 65: Software reset through I<sup>2</sup>C

#### 13.4.2. Device address reload

(0x00, 0x04) activates the I<sup>2</sup>C address stored in register 0xCA. Note that the the values of A0 and A1 cannot be changed by software. Therefore, this general call command only works for bits 2 to 6 of register 0xCA (chapter 5.6.3).

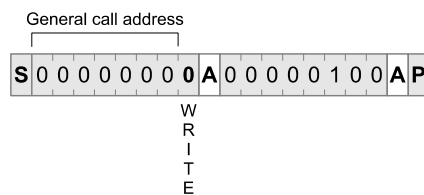

Figure 66: Device address A1, A0 reload through I<sup>2</sup>C

### 13.4.3. Write single-byte

During a single-byte write, only one register is written. After the device address is transmitted, the master has to transmit the register address and the write data in two I<sup>2</sup>C data packets (67). The access is terminated by a STOP condition.

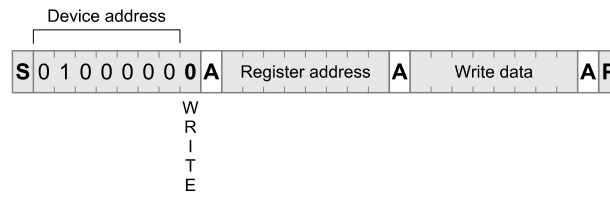

Figure 67: Single-byte Write access through I<sup>2</sup>C

### 13.4.4. Write multi-byte

During a multi-byte write operation, the master transmits the device address and the address of the first register to be written. All subsequent bytes until the STOP condition are interpreted as write data packets (68). The write address pointer is incremented internally. Do not transmit more bytes that the write address pointer reaches the limit of the address space (see chapter 14, 33 and 34).

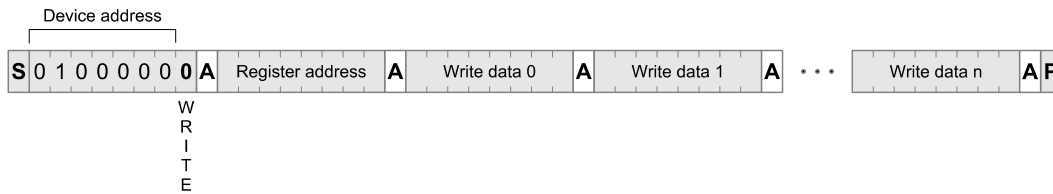

Figure 68: Multi-byte Write access through I<sup>2</sup>C

### 13.4.5. Read single-byte

The master transmits first the device address with a write command. Next, it writes the register address to be read. Then, the master transmits the device address again with a read command where the epc660 answers with the data stored in the addressed register. Finally, the master terminates the read sequence with a NACK and a STOP (69).

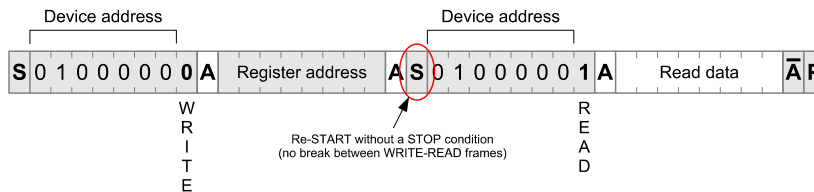

Figure 69: Single-byte Read access through I<sup>2</sup>C

### 13.4.6. Read multi-byte

The master transmits first the device address and the address of the first register to be read. After the epc660 is addressed with a read command, epc660 answers with read data bytes until the master does not acknowledge a byte. The master is expected to terminate the access with a STOP condition thereafter (70). During the access the read address pointer is incremented epc660 internally. Do not transmit more bytes that the write address pointer reaches the limit of the address space (see chapter 14, 33 and 34).

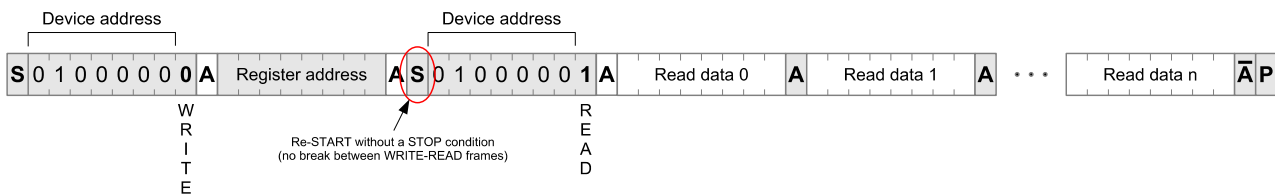

Figure 70: Multi-byte Read access through I<sup>2</sup>C

### 13.5. Command timing

The operating modes of the epc660 are initialized, activated, deactivated and monitored by sending several single or multi-byte write and read command sequences through I<sup>2</sup>C interface. This section lists and explains available commands together with their access time ( $f_{SCL} = 1\text{MHz} \rightarrow t_{SCL} = 1\mu\text{s}$ ).

There is no particular order defined for sending the commands. The only requirement is having no on-going frame acquisition process when updating non-shadowed registers. The registers marked with \*\* in the register map can be updated on-the-fly during a frame acquisition. New values are used by the next frame.

Command	Description	Length [Bytes]	Time [ $\mu\text{s}$ ]
Single-byte Write	Single-byte write to control registers	3	29
Multiple-byte Write	Multiple-byte write (n bytes) to control registers	2 + n	20 + n x 9
Single-byte Read	Single-byte read from control registers	4	39
Multiple-byte Read	Multiple-byte read (n bytes) from control registers	3 + n	30 + n x 9
Mode set	4, 2, or 1 DCS set using register 0x92	3	29
Integration time (short) set	Integration time set (up to 800 $\mu\text{s}$ ) using integration length 1 register	4	38
Integration time (long) set	Integration time set using integration time multiplier and length 1 registers	6	56
Dual Integration time (long) set	Dual int. time set using integration time multiplier and length 1, 2 registers	8	74
Binning, resolution reduction set	Binning and row reduction set using register 0x94	3	29
ROI set	Region of interest set using registers 0x96 – 0x9B.	8	74
Shutter	Start frame acquisition by using the shutter control register	3	29
Integration time (short) + Shutter	Integration time + soft shutter in one go! (Integration length 1 registers, shutter control register)	5	47
EEPROM Indirect Single Write	Indirect single write to EEPROM	9	20ms
EEPROM Indirect Single Read	Indirect single read from EEPROM	10	97

Table 32: I<sup>2</sup>C Control commands summary

## 14. Register map

Notes:

\*\* Shadow registers can be updated on-the-fly while a frame acquisition is going on. The new values are used at the start of the next frame.

Not listed registers are reserved and must not be altered by the user. Otherwise, chip malfunction can occur. However, if a register is accidentally overwritten, a RESET restores the factory settings.

The listed default values are after downloading the latest sequencer program to the chip.

14.1. Control page 0x00 ~ 0x7F

Addr.	Type	Default	Description																																	
0x00	R	---	IC type for device family identification. For chip type refer to register 0xFA.																																	
0x01	R	---	IC version for device mask identification. For chip version refer to register 0xFB.																																	
0x11	R/W	---	Address register for indirect read/write access to EEPROM (refer to 15.6 and 15.7)																																	
0x12	R/W	---	Data register for indirect read/write access to EEPROM (refer to 15.6 and 15.7)																																	
0x20	R	0x00	Strap scan register. Refer to 5.6.3.																																	
			<table border="1"> <thead> <tr> <th>Bit</th> <th>Function</th> <th>Default</th> </tr> </thead> <tbody> <tr> <td>0..4</td> <td>reserved</td> <td>0</td> </tr> <tr> <td>5</td> <td>Strap input 0: I<sup>2</sup>C address A0</td> <td>0</td> </tr> <tr> <td>6</td> <td>Strap input 1: I<sup>2</sup>C address A1</td> <td>0</td> </tr> <tr> <td>7</td> <td>reserved</td> <td>0</td> </tr> </tbody> </table>	Bit	Function	Default	0..4	reserved	0	5	Strap input 0: I <sup>2</sup> C address A0	0	6	Strap input 1: I <sup>2</sup> C address A1	0	7	reserved	0																		
			Bit	Function	Default																															
			0..4	reserved	0																															
			5	Strap input 0: I <sup>2</sup> C address A0	0																															
6	Strap input 1: I <sup>2</sup> C address A1	0																																		
7	reserved	0																																		
Default start-up values of these registers are only valid until end of reset phase. Values might be overwritten by external pull-up resistors during strap scan phase when reset is released.																																				
0x22	R/W	0x30	DCS and ABS selection for 1 <sup>st</sup> frame. Refer to chapter 8.2.																																	
			<table border="1"> <thead> <tr> <th>Bit</th> <th>Function</th> <th>Default</th> </tr> </thead> <tbody> <tr> <td>0</td> <td>DCS number for mgx0 modulator (mga0, mgb0), all modes</td> <td>0</td> </tr> <tr> <td rowspan="4">1</td> <td>00: DCS 0</td> <td rowspan="4">0</td> </tr> <tr> <td>01: DCS 1</td> </tr> <tr> <td>10: DCS 2</td> </tr> <tr> <td>11: DCS 3</td> </tr> <tr> <td>2</td> <td>DCS number for mgx1 modulator (mga1, mgb1), dual modes only</td> <td>0</td> </tr> <tr> <td rowspan="4">3</td> <td>00: DCS 0</td> <td rowspan="4">0</td> </tr> <tr> <td>01: DCS 1</td> </tr> <tr> <td>10: DCS 2</td> </tr> <tr> <td>11: DCS 3</td> </tr> <tr> <td>4</td> <td>Extended background suppression ABS. Refer to chapter 1.6 and 8.3.</td> <td>1</td> </tr> <tr> <td rowspan="3">5</td> <td>00: ABS disabled, Saturation detection not active</td> <td rowspan="3">1</td> </tr> <tr> <td>01: reserved</td> </tr> <tr> <td>10: reserved</td> </tr> <tr> <td>11: ABS enabled (default). Refer to 6</td> <td rowspan="2">0</td> </tr> <tr> <td>6, 7</td> <td>reserved</td> </tr> </tbody> </table>	Bit	Function	Default	0	DCS number for mgx0 modulator (mga0, mgb0), all modes	0	1	00: DCS 0	0	01: DCS 1	10: DCS 2	11: DCS 3	2	DCS number for mgx1 modulator (mga1, mgb1), dual modes only	0	3	00: DCS 0	0	01: DCS 1	10: DCS 2	11: DCS 3	4	Extended background suppression ABS. Refer to chapter 1.6 and 8.3.	1	5	00: ABS disabled, Saturation detection not active	1	01: reserved	10: reserved	11: ABS enabled (default). Refer to 6	0	6, 7	reserved
			Bit	Function	Default																															
			0	DCS number for mgx0 modulator (mga0, mgb0), all modes	0																															
			1	00: DCS 0	0																															
				01: DCS 1																																
				10: DCS 2																																
				11: DCS 3																																
2	DCS number for mgx1 modulator (mga1, mgb1), dual modes only	0																																		
3	00: DCS 0	0																																		
	01: DCS 1																																			
	10: DCS 2																																			
	11: DCS 3																																			
4	Extended background suppression ABS. Refer to chapter 1.6 and 8.3.	1																																		
5	00: ABS disabled, Saturation detection not active	1																																		
	01: reserved																																			
	10: reserved																																			
11: ABS enabled (default). Refer to 6	0																																			
6, 7		reserved																																		
0x24	R/W	0x00	Modulation control 1 <sup>st</sup> frame. Refer to chapter 8.2.																																	
			<table border="1"> <thead> <tr> <th>Bit</th> <th>Function</th> <th>Default</th> </tr> </thead> <tbody> <tr> <td rowspan="3">0..3</td> <td>reserved</td> <td rowspan="3">0</td> </tr> <tr> <td>0: LED/LD is modulated</td> </tr> <tr> <td>1: LED/LD on during integration: Refer to IMPORTANT NOTE chapter 5.7</td> </tr> <tr> <td rowspan="2"></td> <td>0: LED/LD is modulated</td> <td rowspan="2">0</td> </tr> <tr> <td>1: LED/LD off during integration</td> </tr> <tr> <td>6, 7</td> <td>reserved</td> <td>0</td> </tr> </tbody> </table>	Bit	Function	Default	0..3	reserved	0	0: LED/LD is modulated	1: LED/LD on during integration: Refer to IMPORTANT NOTE chapter 5.7		0: LED/LD is modulated	0	1: LED/LD off during integration	6, 7	reserved	0																		
			Bit	Function	Default																															
			0..3	reserved	0																															
				0: LED/LD is modulated																																
				1: LED/LD on during integration: Refer to IMPORTANT NOTE chapter 5.7																																
	0: LED/LD is modulated	0																																		
	1: LED/LD off during integration																																			
6, 7	reserved	0																																		
0x25	R/W	0x35	DCS and ABS selection for 2 <sup>nd</sup> frame. Description see register 0x22.																																	
0x27	R/W	0x00	Modulation control 2 <sup>nd</sup> frame. Description see register 0x24.																																	
0x28	R/W	0x3A	DCS and ABS selection for 3 <sup>rd</sup> frame. Description see register 0x22.																																	
0x2A	R/W	0x00	Modulation control 3 <sup>rd</sup> frame. Description see register 0x24.																																	
0x2B	R/W	0x3F	DCS and ABS selection for 4 <sup>th</sup> frame. Description see register 0x22.																																	
0x2D	R/W	0x00	Modulation control 4 <sup>th</sup> frame. Description see register 0x24.																																	
0x3A	R/W	0x00	Readout mode for grayscale 0x10: single-ended readout (negative numbers are clipped) 0x00: differential readout. Select this mode by the user application, refer to chapter 9.3 and 10.1																																	
0x3C	R/W	0x26	Modulation control in grayscale mode. Refer to chapter 9.3 and 26.																																	
			<table border="1"> <thead> <tr> <th>Bit</th> <th>Function</th> <th>Default</th> </tr> </thead> <tbody> <tr> <td>0</td> <td>reserved</td> <td>0</td> </tr> <tr> <td rowspan="2">1..2</td> <td>reserved</td> <td rowspan="2">1</td> </tr> <tr> <td></td> </tr> <tr> <td>3</td> <td>reserved</td> <td>0</td> </tr> <tr> <td rowspan="2">4</td> <td>0: LED/LD modulated</td> <td rowspan="2">0</td> </tr> <tr> <td>1: LED/LD on during integration</td> </tr> <tr> <td rowspan="2">5</td> <td>0: LED/LD modulated</td> <td rowspan="2">1</td> </tr> <tr> <td>1: LED/LD off during integration</td> </tr> <tr> <td>6..7</td> <td>reserved</td> <td>0</td> </tr> </tbody> </table>	Bit	Function	Default	0	reserved	0	1..2	reserved	1		3	reserved	0	4	0: LED/LD modulated	0	1: LED/LD on during integration	5	0: LED/LD modulated	1	1: LED/LD off during integration	6..7	reserved	0									
			Bit	Function	Default																															
			0	reserved	0																															
			1..2	reserved	1																															
			3	reserved	0																															
4	0: LED/LD modulated	0																																		
	1: LED/LD on during integration																																			
5	0: LED/LD modulated	1																																		
	1: LED/LD off during integration																																			
6..7	reserved	0																																		

Table 33: Address map of the control page (0x00 ~ 0x7F)

Addr.	Type	Default	Description												
0x60	R	---	Temperature sensor top left, refer to chapter 10.												
0x61	R	---	Sum of 4 consecutive readings of the temperature sensor every 4th row reading												
0x62	R	---	Temperature sensor top right.												
0x63	R	---	Description see register 0x60.												
0x64	R	---	Temperature sensor bottom left.												
0x65	R	---	Description see register 0x60.												
0x66	R	---	Temperature sensor bottom right												
0x67	R	---	Description see register 0x60.												
0x71	R/W	0x00	Number of fine DLL delay steps to delay the LED output by approx. 10ps per step. Max. value is 799 (0x31F). Valid only if bit 2 in register 0xAE is enabled. Refer also to register 0xAE and chapter 5.8. Note: Delay is sensitive to VDD variations and noise.												
0x72	R/W	0x00													
0x73	R/W	0x00	Number of coarse DLL delay steps to delay the LED output by approx. 2ns per step. Max. value is 49 (0x31). Valid only if bit 2 in register 0xAE is enabled. Refer also to register 0xAE and chapter 5.8. Note: Delay is sensitive to VDD variations and noise.												
0x7D	R/W	0x04	Mode control												
			<table border="1"> <thead> <tr> <th>Bit</th> <th>Function</th> <th>Default</th> </tr> </thead> <tbody> <tr> <td>0..1</td> <td>reserved</td> <td>0</td> </tr> <tr> <td>2</td> <td>Enable PLL 0: disable 1: enable</td> <td>1</td> </tr> <tr> <td>3..7</td> <td>reserved</td> <td>0</td> </tr> </tbody> </table>	Bit	Function	Default	0..1	reserved	0	2	Enable PLL 0: disable 1: enable	1	3..7	reserved	0
			Bit	Function	Default										
			0..1	reserved	0										
2	Enable PLL 0: disable 1: enable	1													
3..7	reserved	0													

Cont. 33: Address map of the control page (0x00 ~ 0x7F)

#### 14.2. RAM page (0x80 ~ 0xEF)

Addr.	Type	Default	Description												
0x80	R/W	0x3F	Clock control												
			<table border="1"> <thead> <tr> <th>Bit</th> <th>Function</th> <th>Default</th> </tr> </thead> <tbody> <tr> <td>0..5</td> <td>reserved</td> <td>1</td> </tr> <tr> <td>6</td> <td>Modulation clock source 0: Internal modulation clock 1: External clock from MODCLK input</td> <td>0</td> </tr> <tr> <td>7</td> <td>reserved</td> <td>0</td> </tr> </tbody> </table>	Bit	Function	Default	0..5	reserved	1	6	Modulation clock source 0: Internal modulation clock 1: External clock from MODCLK input	0	7	reserved	0
			Bit	Function	Default										
			0..5	reserved	1										
6	Modulation clock source 0: Internal modulation clock 1: External clock from MODCLK input	0													
7	reserved	0													

Addr.	Type	Default	Description																			
0x85	R/W	0x01	Modulation clock divider																			
			<table border="1"> <thead> <tr> <th>Bit</th> <th>Function</th> <th>Default</th> </tr> </thead> <tbody> <tr> <td>0</td> <td rowspan="2">Modulation clock divider provides clock to the LED/Pixel-field modulator/demodulator circuits by integer division of the internal PLL clock or external MODCLK:</td> <td>1</td> </tr> <tr> <td>1</td> <td>0</td> </tr> <tr> <td>2</td> <td rowspan="2"><math>f_{\text{mod\_clk}} = 96\text{MHz} / (\text{modulation clock divider} + 1)</math> Default: <math>96\text{MHz} / (0x01 + 0x01)</math>: <math>f_{\text{mod\_clk}} = 48\text{MHz}</math></td> <td>0</td> </tr> <tr> <td>3</td> <td>0</td> </tr> <tr> <td>4</td> <td>Note: The LED modulation frequency is 4 times lower than <math>f_{\text{mod\_clk}}</math></td> <td>0</td> </tr> <tr> <td>5..7</td> <td>reserved</td> <td>0</td> </tr> </tbody> </table>	Bit	Function	Default	0	Modulation clock divider provides clock to the LED/Pixel-field modulator/demodulator circuits by integer division of the internal PLL clock or external MODCLK:	1	1	0	2	$f_{\text{mod\_clk}} = 96\text{MHz} / (\text{modulation clock divider} + 1)$ Default: $96\text{MHz} / (0x01 + 0x01)$ : $f_{\text{mod\_clk}} = 48\text{MHz}$	0	3	0	4	Note: The LED modulation frequency is 4 times lower than $f_{\text{mod\_clk}}$	0	5..7	reserved	0
			Bit	Function	Default																	
			0	Modulation clock divider provides clock to the LED/Pixel-field modulator/demodulator circuits by integer division of the internal PLL clock or external MODCLK:	1																	
			1		0																	
			2	$f_{\text{mod\_clk}} = 96\text{MHz} / (\text{modulation clock divider} + 1)$ Default: $96\text{MHz} / (0x01 + 0x01)$ : $f_{\text{mod\_clk}} = 48\text{MHz}$	0																	
3	0																					
4	Note: The LED modulation frequency is 4 times lower than $f_{\text{mod\_clk}}$	0																				
5..7	reserved	0																				

Table 34: Address map of RAM page (0x80 ~ 0xEF)



Addr.	Type	Default	Description		
0x89	R/W	0x03	TCMI clock control		
			<b>Bit</b>	<b>Function</b>	<b>Default</b>
			0	TCMI clock divider:	1
			1	$f_{\text{TCMI\_clk}} = 96\text{MHz} / (\text{TCMI clock divider} + 1)$ Default: $96\text{MHz} / (0x03 + 0x01) = 24\text{MHz}$	1
			2	Minimal value of TCMI clock divider = $0x01 = 48.0\text{MHz}$	0
			3	Maximal value of TCMI clock divider = $0x1F = 3.0\text{MHz}$ Important: Regarding readout rollover, refer to 29 and register 0x91 regarding	0
			4	DCLK stretch	0
			5..6	reserved	0
7	DCLK skew enable: 0: disable 1: enable Used to delay DCLK edge (typ. 2ns) to compensate PCB delays. Might be particularly useful when TCMI clock divider = 0 (divided by 1). When set normal, DCLK edge is centred with respect to other TCMI *SYNC*, DATA[11:0] outputs.	0			
0x8B	R/W	0x01	Number of PLL clock periods delay of the demodulation signal path (all modulation modes). It can be used to insert a phase shift between modulation (LED) and demodulation (pixel). 1 PLL clock cycle is around 10.4ns @ 96MHz PLL clock. This is equivalent to a distance shift of 1.5625m independent of the LED modulation frequency. Note: This phase shift is temperature independent. 0: no delay 1: 1 clock 2: 2 clocks ... 12: 12 clocks (max. value)		
0x90	R/W	0xC4	LED driver control. Refer to chapter 5.3 and 5.7.		
			<b>Bit</b>	<b>Function</b>	<b>Default</b>
			0	reserved	0
			1	Inverts output signals LED and LED2 if drivers are enabled 0: not inverted, e.g. LED = 0, not active: Pin LED non-conductive, LED2 = VSSIO. 1: inverted, e.g. LED = 0, not active: Pin LED conductive, LED2 = VDDIO.	0
			2	LED output select: 0: LED driver is disable. Pin LED is non-conductive. 1: LED driver is enabled.	1
			3	reserved	0
			4	LED/LD permanently on (torch function, no modulation) if drivers are enabled: 0: off 1: on (Refer to IMPORTANT NOTE chapter 5.7)	0
			5	LED2 output select: 0: LED2 driver disabled. Output is in Tri-State with termination resistor to VSSIO. 1: LED2 driver enabled.	0
6..7	reserved	1			
0x91	R/W	0x03	Sequencer control		
			<b>Bit</b>	<b>Function</b>	<b>Default</b>
			0..1	reserved	1
			3..5	reserved	0
			6	Avoids readout rollover when using slower DCLK < 13MHz and default ROI. Stretches HSYNC for slower TCMI interface. Causes reduced DCS frame rate due to additional 2µs per ADC conversion ( $t_{\text{conv}} + 2\mu\text{s}$ ). Refer also to register 0x89. 0: disable (default) 1: enable for DCLK < 13MHz and default ROI. Refer to 29 and note above.	0
7	reserved	0			

Cont. 34: Address map of RAM page (0x80 ~ 0xEF)

Addr.	Type	Default	Description		
0x92**	R/W	0x34	Modulation select		
			<b>Bit</b>	<b>Function</b>	<b>Default</b>
			0..1	reserved	0
			2	reserved	1
			3	Dual integration time mode – acquisition with 2 integration times per DCS frame using additionally integration length 2, registers 0x9E and 0x9F 0: disable 1: enable Needs register 0x94 set to 0x80, otherwise it is not effective (see 42)	0
			4	Number of DCS readouts select: 00: Grayscale mode, DCS0 only	1
			5	01: Dual phase mode, DCS0, DCS1 or DCS2,DCS3 10: reserved 11: Full resolution mode or dual int. mode, DCS0, DCS1, DCS2, DCS3	1
			6	Modulation select: 00: TOF mode	0
7	01: reserved 10: reserved 11: Grayscale mode	0			
0x94**	R/W	0x00	Resolution reduction, binning and pixel-field mode		
			<b>Bit</b>	<b>Function</b>	<b>Default</b>
			0	Column reduction: resolution on x-axis. Refer to chapter 8.2.5. 00: no (0, 1, 2, ...)	0
			1	01: by half (0, 2, 4, ...) 10 & 11: reserved	0
			2	Row reduction: resolution on y-axis. Refer to chapter 8.2.5 00: no (0, 1, 2, ...)	0
			3	01: by half (0, 2, 4, ...) 10: a quarter (0, 4, 8, ...) 11: one eight (0, 8, 16, ...)	0
			4	Pixel binning. Refer to chapter 8.2.4. 00: no binning	0
			5	01: binning x-axis if bit 0, 1 <> 00 10: binning y-axis if bit 2, 3 <> 00 11: binning x and y-axis if bit 0, 1 <> 00 AND bit 2, 3 <> 00 Notes: - Choose corresponding row and/or column reduction to binning selection. - Binning cannot be used with dual phase and dual integration time mode.	0
6	reserved	0			
7	Select pixel-field mode (refer to chapter 8.2.1, 8.2.2, 8.2.3) 0: Standard TOF mode: full resolution 1: Dual modes: dual phase and dual integration time	0			
0x96**	R/W	0x00	ROI top left X setting. Refer to chapter 8.2.6.		
0x97**	R/W	0x04			
0x98**	R/W	0x01	ROI bottom right X setting.		
0x99**	R/W	0x43			
0x9A**	R/W	0x06	ROI top left Y setting.		
0x9B**	R/W	0x7D	ROI bottom right Y setting.		
0x9E**	R/W	0x07	Integration length 2: Number of modulation clock periods for the second integration time in the dual integration time mode (refer to 8.2.3, default: 2'047). See registers 0xA2 and 0xA3 for functional definition details.		
0x9F**	R/W	0xFF	Bit 3 in register 0x92 has to be set to 1 to enable this integration time for the even rows. The odd rows operate with the integration length 1 set in registers 0xA2 and 0xA3.		
0xA0**	R/W	0x00	Integration time multiplier (10 bit value) for integration lengths set with the integration length registers (default = 1, min. value = 1). This multiplier is active on both settings integration length 1 and 2.		
0xA1**	R/W	0x01			
0xA2**	R/W	0x07	Integration length 1: Number of modulation clock periods for the (first in dual integration time mode ) integration time (16 bit value, default = 2'047, min. value = 7 which is integration time 167ns @ 12MHz). Integration time = Integration time multiplier * (Integration length + 1) * t <sub>mod_clk</sub> e.g. for defaults @ 12MHz modulation clock = 42.6µs		
0xA3**	R/W	0xFF	Note: (Integration length + 1) should be evenly divisible by 4.		

Cont. 34: Address map of RAM page (0x80 ~ 0xEF)

Addr.	Type	Default	Description			
0xA4	R/W	0x00	Shutter Control			
			<b>Bit</b>	<b>Function</b>	<b>Default</b>	
			0	Shutter release. Refer to chapter 6.2. 0: disable 1: enable. In single shot mode: Starts acquisition and is auto cleared. Note: Shutter release is not auto-cleared when multiple frames is enable.	0	
			1	Multiple frames (auto-run or video mode). Refer to chapter 6.2. 0: disable. Single shot mode. 1: enable. Multiple frame mode active if shutter enabled. Refer to chapter 6.2.2.	0	
2..7	reserved	0				
0xA5	R/W	0x07	Power control. Refer to chapter 11.6. 0x00: Power off 0x07: Power on			
0xAE	R/W	0x01	DLL control (Refer also to register 0x73 and chapter 5.8) 0x01: no delay 0x04: delay manually set by register 0x73 Note: The change of register 0xAE from 0x01 to 0x04 generates also a delay, even if register 0x73 is set to 0x00.			
0xCA	R/W	0x20	I <sup>2</sup> C addressing			
			<b>Bit</b>	<b>Function</b>	<b>Default</b>	
			0	I <sup>2</sup> C device address A6 ... A2 of 7-bit I <sup>2</sup> C device address. Programmable via direct access from I <sup>2</sup> C or from EEPROM during start up, followed by an I <sup>2</sup> C general call "Device address reload" to take it into effect.	0	
			1		reserved, I <sup>2</sup> C address A1, A0 of 7-bit I <sup>2</sup> C device address. Programmable only during reset via strap pins using external pull-up resistors.	0
			2		0	
			3		0	
			4		0	
			5		1	
			6		0	
7	reserved	0				
0xCB	R/W	0x03	I <sup>2</sup> C and TCMI control. Refer to chapter 13 and 6.4.			
			<b>Bit</b>	<b>Function</b>	<b>Default</b>	
			0	I <sup>2</sup> C clock stretching 0: disabled 1: enabled	1	
			1	I <sup>2</sup> C pins input spike filter 0: disabled (> 1MHz) 1: enabled (≤ 1MHz, FM+) When I <sup>2</sup> C pins input spike filter = 0, SDA and SCL pins can be used up to 10MHz as inputs (driven rail-to-rail by a real CMOS driver, no pull-up) and up to 2MHz as outputs.	1	
			2, 3	reserved	0	
			4	00: Transfers 12 bit pixel data with 1x DCLK (default). 01: Transfers the 8 MSB bits of the pixel data with 1x DCLK. Data are LSB aligned.	0	
			5	10: lsb/msb split mode: Transfers 12 bit pixel data with LSByte leading and MS-Byte trailing with 2x DCLK. Data are LSB aligned (default). The optional SAT bit is on the LSB. 11: msb/lsb split mode: Transfers 12 bit pixel data with MSByte leading and LS-Byte trailing with 2x DCLK. Data are LSB aligned. The optional SAT bit is on the LSB.		
			6	When split modes selected (= 11 or 10), forces bit DATA[0] of the LSByte = 1 when the pixel is saturated. Not effective with other TCMI data formats. 0: disabled 1: enabled	0	
			7	reserved	0	

Cont. 34: Address map of RAM page (0x80 ~ 0xEF)

Addr.	Type	Default	Description		
0xCC	R/W	0x41	TCMI polarity settings. Refer to chapter 6.4.		
			<b>Bit</b>	<b>Function</b>	<b>Default</b>
			0	DCLK edge select to align all other TCMI outputs 0: falling edge 1: rising edge	1
			1	HSYNC polarity 0: HSYNC active low 1: HSYNC active high	0
			2	VSYNC polarity 0: VSYNC active low 1: VSYNC active high	0
			3	XSYNC polarity 0: XSYNC active low 1: XSYNC active high Only effective when bit 6 is set to 0	0
			4	DATA[11:0] unsigned/signed TCMI data output format 0: unsigned integer, subtract 2 <sup>048</sup> to get correct value (Default) 1: two's complement signed integer (-2 <sup>048</sup> ... 2 <sup>047</sup> )	0
			5	reserved	0
			6	Select XSYNC / SAT output pin function 0: XSYNC 1: SAT	1
7	Force DATA[11:0] = 0xFFF (unsigned) / 0x7FF (signed, two's complement) during data-out operation when corresponding pixel is saturated 0: disabled 1: enabled	0			
0xE8	R/W	---	Temperature offset correction for sensor top left. Value for calculation according the formula in chapter 10 by the application SW. Range approx. -27 ... +27°C with around 0.2°C steps. The reference temperature is +27°C. 0x7F (127) corresponds to 0°C offset. 0xFF: Function is not supported.		
0xAE0x-AE0xE9	R/W	---	DLL step. Supported for Wafer IDs 212 or higher. Refer for details to register 0x73 and 22. The exact value is $t_{DLL} = ((\text{register } 0xE9 - 128) * 0.003\text{ns}) + 2.1\text{ns}$ (at +27°C, $V_{DD}, V_{DDPLL} = 1.8\text{V}$ ). 0xFF: Function is not supported.		
0xEA	R/W	---	Temperature offset correction for sensor top right. Description see register 0xE8.		
0xEC	R/W	---	Temperature offset correction for sensor bottom left. Description see register 0xE8.		
0xEE	R/W	---	Temperature offset correction for sensor bottom right. Description see register 0xE8.		

Cont. 34: Address map of RAM page (0x80 ~ 0xEF)

#### 14.3. EEPROM page, indirect data access section (0xF0 ~ 0xFF)

Addr.	Type	Default	Description
0xF0	R/W	0x00	User register for user data. Do not write the register during frame acquisition. The number of WRITE cycles into the EEPROM should not exceed 100 WRITE operations.
0xF5	R	0x00	Customer ID
0xF6	R	---	Wafer ID
0xF7	R	---	
0xF8	R	---	Chip ID
0xF9	R	---	
0xFA	R	0x02	Chip and part type: 0x02 = epc660
0xFB	R	---	Chip and part version (release) e.g. 0x07 for version -007, 0x0B for version -011

Table 35: Address map of EEPROM page (0xF0 ~ 0xFF)

## 15. Control command examples

### 15.1. I<sup>2</sup>C control command examples:

To simplify command sequence definitions, following C-programming language style functions are defined for the I<sup>2</sup>C master CPU:

- i2cGeneralCall(byte genAdr, byte cmd); // 20 x t<sub>SCL</sub> = 20μs
- i2cSingleWrite(byte devAdr, byte regAdr, byte regVal); // 29 x t<sub>SCL</sub> = 29μs
- i2cMultiWrite(byte devAdr, byte regAdr, byte\* regVal, byte n // 20 + (n x 9 x t<sub>SCL</sub>) = 20 + (n x 9)μs
- byte i2cSingleRead(byte devAdr, byte regAdr); // 39 x t<sub>SCL</sub> = 39μs
- byte\* i2cMultiRead(byte devAdr, byte regAdr, byte n); // 30 + (n x 9 x t<sub>SCL</sub>) = 30+(n x 9)μs

### 15.2. Software reset with I<sup>2</sup>C general call command

PRECONDITION: None

1. i2cGeneralCall(0x00, 0x06); // Software reset, same effect like  $\overline{\text{RESET}}$  pin, 20μs
2. ... // Wait for t<sub>RESET</sub> (> 100ns)

### 15.3. 4 DCS: Acquire DCS0 ... 3 frames with t<sub>int</sub> = 16.6μs @ 12MHz modulation frequency

PRECONDITION: All other registers contain default values.

1. i2cSingleWrite(0x20, 0x92, 0x34); // Modulation control 0x92 = 0x34 (mod. sel. = 00, No. DCS = 11), 29μs
2. i2cMultiWrite(0x20, 0xA2, &(0x031F), 2); // Integration length 1 0xA2/0xA3 = 0x031F (integration time = 16.6μs), 38μs
3. i2cSingleWrite(0x20, 0xA4, 0x01); // Shutter control 0xA4 = 0x01, (shutter release = 1), 29μs
4. ... // Acquisition starts. Wait until all 4x DCS frames are finished.

### 15.4. 4 DCS: Acquire DCS0 ... 3 frames with tint = 16.6μs, followed by DCS 0 ... 3 with tint 333μs @ 12MHz mod. frequency

PRECONDITION: All other registers contain default values.

1. i2cSingleWrite(0x20, 0x92, 0x34); // Modulation control 0x92 = 0x34 (mod. sel. = 00, No. DCS = 11), 29μs
2. i2cMultiWrite(0x20, 0xA2, &(0x031F), 2); // Integration length 1 0xA2/0xA3 = 0x031F (integration time = 16.6μs), 38μs
3. i2cSingleWrite(0x20, 0xA4, 0x01); // Shutter control 0xA4 = 0x01, (shutter release = 1), 29μs
4. ... // Acquisition starts. Wait until all 4x DCS frames are finished.
5. i2cMultiWrite(0x20, 0xA2, &(0x3E7F), 2); // Integration length 1 0xA2/0xA3 = 0x3E7F (integration time = 333μs), 38μs
6. i2cSingleWrite(0x20, 0xA4, 0x01); // Shutter control 0xA4 = 0x01, (shutter release = 1), 29μs
7. ... // Acquisition starts. Wait until all 4x DCS frames are finished.

### 15.5. 2 DCS: Acquire DCS0 and 1 with t<sub>int</sub> = 16.6μs @ 12MHz modulation frequency

PRECONDITION: All other registers contain default values.

1. i2cSingleWrite(0x20, 0x92, 0x14); // Modulation control 0x92 = 0x34 (mod. sel. = 00, No. DCS = 11), 29μs
2. i2cMultiWrite(0x20, 0xA2, &(0x031F), 2); // Integration length 1 0xA2/0xA3 = 0x031F (integration time = 16.6μs), 38μs
3. i2cSingleWrite(0x20, 0xA4, 0x01); // Shutter control 0xA4 = 0x01, (shutter release = 1), 29μs
4. ... // Acquisition starts. Wait until all 2x DCS frames are finished.

### 15.6. Indirect single write to EEPROM: Store 1 byte at user register 0xF0

PRECONDITION: None

1. i2cSingleWrite(0x20, 0x11, 0xF0); // EEPROM address register 0x11 = 0xF0, 29μs
2. i2cSingleWrite(0x20, 0x12, 0x22); // EEPROM data register 0x12 = 0x22  
// (user register = 0x22), 29μs + 20ms = ~20ms
3. ...

Note 1: Start address is written in address register 0x11 for indirect read/write access to the EEPROM.

Note 2: Each EEPROM data register write starts erase/programming EEPROM.

Each EEPROM write takes 20ms, then it auto-increments the EEPROM address register 0x11 by 1.

Note 3: Corresponding control register value is not modified. Only EEPROM register is modified.

Note 4: EEPROM content will only be copied to corresponding control register after RESET.

### 15.7. Indirect single read from EEPROM: Read 1 byte from user register 0xF0

PRECONDITION: None

1. i2cSingleWrite(0x20, 0x11, 0xF0); // EEPROM address register 0x11 = 0xF0, 29μs
2. cal1 = i2cSingleRead(0x20, 0x12); // user value 1 = EEPROM data register (user register 1 0xF0), 39μs
3. ...

Note 1: Start address is written in the EEPROM address register 0x11.

Note 2: Corresponding control register value is not modified. Only EEPROM is read.

### 15.8. Reading part version (register 0xFB)

Since there is no RAM register at address 0xFB, the PART VERSION can only be read directly from the EEPROM.

```
# The syntax of the I2C commands is as follows:
# Reading: i2c r REGISTER_ADDRESS [NUMBER_OF_BYTES]
# Writing: i2c w REGISTER_ADDRESS [DATA1 DATA2 ...]

i2c w 11 FB
i2c r 12 01 # Response: PART VERSION
```

### 15.9. Reading IC version (register 0x01)

I<sup>2</sup>C command to read IC version

```
# The syntax of the I2C commands is as follows:
# Reading: i2c r REGISTER_ADDRESS [NUMBER_OF_BYTES]
# Writing: i2c w REGISTER_ADDRESS [DATA1 DATA2 ...]

i2c r 01 01 # Response: IC VERSION
```

### 15.10. Reading WAFER ID and CHIP ID

It can be necessary for technical support to read the WAFER ID and the CHIP ID. Since there are no RAM register at addresses 0xF6 to 0xF9, the WAFER ID and the CHIP ID can only be read directly from the EEPROM.

```
# The syntax of the I2C commands is as follows:
# Reading: i2c r REGISTER_ADDRESS [NUMBER_OF_BYTES]
# Writing: i2c w REGISTER_ADDRESS [DATA1 DATA2 ...]

i2c w 11 F6
i2c r 12 01 # Response: WAFER ID MSB
i2c r 12 01 # Response: WAFER ID LSB
i2c r 12 01 # Response: CHIP ID MSB
i2c r 12 01 # Response: CHIP ID LSB
```

### 15.11. Pixel sequencer code write procedure

1. Startup epc660 chip (power up or reset release).
2. Wait until the chip is in READY state.
3. Write the pixel sequencer code from chapter 15.12 to the memory.

#### Important Notes:

This procedure has to be executed after every power up or after a chip reset release (refer also to chapter 11.1).

Never modify this code sequence. Otherwise malfunction occurs.

### 15.12. Pixel sequencer code

```
# Pixel Sequencer Code V11
# The following sequence of I2C commands re-program the sequencer to be on most actual functionality.
#
# The syntax of the I2C commands to the imager is as follows:
# Writing: i2c w REGISTER_ADDRESS [RAM_ADDRESS DATA0 DATA1 DATA2 DATA3 DATA4 DATA5 SR_PROGRAM]

i2c w a4 00
i2c w 91 00
i2c w 47 01
i2c w 40 00 43 10 00 C0 00 00 0D
i2c w 40 01 43 10 00 00 01 00 0D
i2c w 40 02 43 10 00 40 0A 00 0D
i2c w 40 03 43 10 10 02 58 00 0D
i2c w 40 04 43 10 20 01 80 00 0D
i2c w 40 05 43 10 F0 01 B0 00 0D
i2c w 40 06 43 10 00 01 60 00 0D
i2c w 40 07 43 10 C0 00 78 00 0D
i2c w 40 08 43 00 40 00 18 00 0D
i2c w 40 09 43 00 D0 02 40 00 0D
i2c w 40 0A 43 00 10 C0 1E 00 0D
i2c w 40 0B 43 10 00 00 50 00 0D
i2c w 40 0C 43 00 20 00 18 00 0D
i2c w 40 0D 43 00 D0 02 40 00 0D
i2c w 40 0E 43 00 10 C0 1E 00 0D
i2c w 40 0F 43 10 00 00 50 00 0D
i2c w 40 10 43 00 D0 02 40 00 0D
i2c w 40 11 43 10 00 00 50 00 0D
i2c w 40 12 43 08 40 40 02 00 0D
i2c w 40 13 43 08 02 00 00 00 0D
i2c w 40 14 43 08 00 00 A8 00 0D
i2c w 40 15 43 18 80 07 0C 00 0D
i2c w 40 16 43 08 00 00 00 00 0D
```

i2c w 40 17 43 08 01 00 00 00 0D  
i2c w 40 18 43 08 00 00 A8 00 0D  
i2c w 40 19 03 08 30 03 40 00 0D  
i2c w 40 1A 03 08 E0 01 60 00 0D  
i2c w 40 1B 03 08 10 C0 02 00 0D  
i2c w 40 1C 03 08 30 03 40 00 0D  
i2c w 40 1D 03 00 00 00 00 00 0D  
i2c w 40 1E 03 00 00 00 50 00 0D  
i2c w 40 1F 43 10 80 40 02 00 0D  
i2c w 40 20 43 10 60 00 50 00 0D  
i2c w 40 21 43 18 60 40 02 00 0D  
i2c w 40 22 43 18 90 07 0C 00 0D  
i2c w 40 23 43 08 01 00 00 00 0D  
i2c w 40 24 43 08 00 00 A8 00 0D  
i2c w 40 25 03 08 30 03 40 00 0D  
i2c w 40 26 03 00 88 00 10 00 0D  
i2c w 40 27 03 00 88 3E 0C 00 0D  
i2c w 40 28 03 00 08 00 14 00 0D  
i2c w 40 29 03 00 80 00 10 00 0D  
i2c w 40 2A 03 00 80 3E 0C 00 0D  
i2c w 40 2B 03 00 00 00 14 00 0D  
i2c w 40 2C 03 00 00 00 50 00 0D  
i2c w 40 2D 43 08 02 00 00 00 0D  
i2c w 40 2E 43 08 00 00 A8 00 0D  
i2c w 40 2F 43 18 00 00 00 00 0D  
i2c w 40 30 43 08 01 00 3C 00 0D  
i2c w 40 31 43 08 00 00 A8 00 0D  
i2c w 40 32 43 08 00 00 14 00 0D  
i2c w 40 33 43 08 00 C0 00 00 0D  
i2c w 40 34 43 08 00 00 01 00 0D  
i2c w 40 35 43 88 00 00 00 00 0D  
i2c w 40 36 43 08 30 0A 0C 00 0D  
i2c w 40 37 43 28 00 00 00 00 0D  
i2c w 40 38 43 08 40 00 0C 00 0D  
i2c w 40 39 43 08 C0 03 88 00 0D  
i2c w 40 3A 43 08 60 09 48 00 0D  
i2c w 40 3B 40 08 00 00 44 00 0D  
i2c w 40 3C 43 08 F0 03 8C 00 0D  
i2c w 40 3D 43 08 50 08 48 00 0D  
i2c w 40 3E 40 08 00 00 44 00 0D  
i2c w 40 3F 43 08 20 04 90 00 0D  
i2c w 40 40 41 08 60 07 48 00 0D  
i2c w 40 41 40 08 00 00 44 00 0D  
i2c w 40 42 41 08 40 04 48 00 0D  
i2c w 40 43 40 08 00 00 44 00 0D  
i2c w 40 44 05 08 00 00 34 00 0D  
i2c w 40 45 04 08 50 00 0C 00 0D  
i2c w 40 46 84 0A F0 00 0C 00 0D  
i2c w 40 47 84 0F 00 00 54 00 0D  
i2c w 40 48 85 0E 10 00 0C 00 0D  
i2c w 40 49 01 0E D0 00 0C 00 0D  
i2c w 40 4A 00 0E 00 00 AC 00 0D  
i2c w 40 4B 40 2E 00 00 00 00 0D  
i2c w 40 4C 40 08 80 05 9C 00 0D  
i2c w 40 4D 40 08 60 00 0C 00 0D  
i2c w 40 4E 41 08 00 00 00 00 0D  
i2c w 40 4F 09 48 00 00 00 00 0D  
i2c w 40 50 08 08 50 00 0C 00 0D  
i2c w 40 51 88 0A F0 00 0C 00 0D  
i2c w 40 52 88 0F 00 00 54 00 0D  
i2c w 40 53 89 0E 10 00 0C 00 0D  
i2c w 40 54 01 0E D0 00 0C 00 0D  
i2c w 40 55 00 0E 00 00 AC 00 0D  
i2c w 40 56 40 2E 00 00 00 00 0D  
i2c w 40 57 40 08 F0 06 94 00 0D  
i2c w 40 58 40 08 F0 06 94 00 0D  
i2c w 40 59 40 08 50 00 0C 00 0D  
i2c w 40 5A 41 08 00 00 00 00 0D  
i2c w 40 5B 11 48 00 00 00 00 0D  
i2c w 40 5C 10 08 50 00 0C 00 0D  
i2c w 40 5D 90 0A F0 00 0C 00 0D  
i2c w 40 5E 90 0F 00 00 54 00 0D  
i2c w 40 5F 91 0E 10 00 0C 00 0D  
i2c w 40 60 01 0E D0 00 0C 00 0D  
i2c w 40 61 00 0E 00 00 AC 00 0D  
i2c w 40 62 40 2E 00 00 00 00 0D  
i2c w 40 63 40 08 F0 06 9C 00 0D  
i2c w 40 64 40 08 60 00 0C 00 0D  
i2c w 40 65 41 08 00 00 00 00 0D  
i2c w 40 66 21 48 00 00 00 00 0D  
i2c w 40 67 20 08 50 00 0C 00 0D  
i2c w 40 68 A0 0A F0 00 0C 00 0D  
i2c w 40 69 A0 0F 00 00 54 00 0D  
i2c w 40 6A A1 0E 10 00 0C 00 0D  
i2c w 40 6B 01 0E D0 00 0C 00 0D  
i2c w 40 6C 00 0E 00 00 AC 00 0D  
i2c w 40 6D 40 2E 00 00 00 00 0D  
i2c w 40 6E 40 08 00 00 00 00 0D  
i2c w 40 6F 40 08 00 C0 03 00 0D  
i2c w 40 70 40 08 50 00 0C 00 0D  
i2c w 40 71 41 48 00 00 14 00 0D

```

i2c w 40 72 00 08 00 00 54 00 0D
i2c w 40 73 00 08 C0 02 0C 00 0D
i2c w 40 74 00 48 00 00 00 00 0D
i2c w 40 75 00 08 00 00 4C 00 0D
i2c w 40 76 15 08 00 00 34 00 0D
i2c w 40 77 14 08 50 00 0C 00 0D
i2c w 40 78 94 0A F0 00 0C 00 0D
i2c w 40 79 94 0F 00 00 54 00 0D
i2c w 40 7A 95 0E 10 00 0C 00 0D
i2c w 40 7B 01 0E D0 00 0C 00 0D
i2c w 40 7C 00 0E 00 00 AC 00 0D
i2c w 40 7D 40 2E 00 00 00 00 0D
i2c w 40 7E 40 08 70 00 0C 00 0D
i2c w 40 7F 41 08 00 00 00 00 0D
i2c w 40 80 29 48 00 00 00 00 0D
i2c w 40 81 28 08 50 00 0C 00 0D
i2c w 40 82 A8 0A F0 00 0C 00 0D
i2c w 40 83 A8 0F 00 00 54 00 0D
i2c w 40 84 A9 0E B0 06 50 00 0D
i2c w 40 85 41 08 00 00 00 00 0D
i2c w 40 86 0D 08 00 00 34 00 0D
i2c w 40 87 0C 08 50 00 0C 00 0D
i2c w 40 88 8C 0A F0 00 0C 00 0D
i2c w 40 89 8C 0F 00 00 54 00 0D
i2c w 40 8A 8D 0E 10 00 0C 00 0D
i2c w 40 8B 01 0E D0 00 0C 00 0D
i2c w 40 8C 00 0E 00 00 AC 00 0D
i2c w 40 8D 40 2E 00 00 00 00 0D
i2c w 40 8E 40 08 F0 06 94 00 0D
i2c w 40 8F 40 08 60 00 0C 00 0D
i2c w 40 90 41 08 00 00 00 00 0D
i2c w 40 91 31 48 00 00 00 00 0D
i2c w 40 92 30 08 50 00 0C 00 0D
i2c w 40 93 B0 0A F0 00 0C 00 0D
i2c w 40 94 B0 0F 00 00 54 00 0D
i2c w 40 95 B1 0E B0 06 50 00 0D
i2c w 40 96 43 08 00 00 00 00 0D
i2c w 40 97 41 08 00 00 00 00 0D
i2c w 40 98 3D 08 00 00 34 00 0D
i2c w 40 99 3C 08 50 00 0C 00 0D
i2c w 40 9A BC 0A F0 00 0C 00 0D
i2c w 40 9B BC 0F 00 00 54 00 0D
i2c w 40 9C BD 0E B0 06 50 00 0D
i2c w 47 00
i2c w 91 03

```

It is possible to read the sequencer code back from memory. This is useful to ensure that the sequencer code is correctly stored and was not accidentally changed during operation.

### 15.13. Pixel sequencer code readback

I2C command to imager	description / comment
i2c w a4 00	#disable acquisition
i2c w 40 00 i2c w 47 09 Data0 = i2c r 41 Data1 = i2c r 42 Data2 = i2c r 43 Data3 = i2c r 44 Data4 = i2c r 45 Data5 = i2c r 46	#set dedicated sequencer RAM address (e.g. address 0x00) #enable pixel sequencer RAM access
i2c w 40 01 i2c w 47 09 Data0 = i2c r 41 Data1 = i2c r 42 Data2 = i2c r 43 Data3 = i2c r 44 Data4 = i2c r 45 Data5 = i2c r 46	#set dedicated sequencer RAM address (e.g. address 0x01) #enable pixel sequencer RAM access
...	...
i2c w 47 00	#disable pixel sequencer RAM access

Read back results (Sequencer V11)

RAM address pixel sequencer	Data0	Data1	Data2	Data3	Data4	Data5
0x00	0x43	0x10	0x00	0xC0	0x00	0x00
0x01	0x43	0x10	0x00	0x00	0x01	0x00
...	...	...	...	...	...	...



#### 15.14. Accuracy improvement

In order to improve distance accuracy and optimize the stability of the operation at low temperature, a fine tuning of an internal current source is recommended. The procedure is to read the chip temperature and change the bias current by adjusting the register 0xCE as follows:

Chip temperature	Bias current compensation (register 0xCE)
below -32°C	+0x30
-32...-15°C	+0x20
-15...3°C	+0x10
3...23°C	0
23...46°C	-0x10
46...69°C	-0x20
above 69°C	-0x30

Table 36: Correction value

Recommended code sequence:

```
# Bias current compensation
# The following sequence adjusts the bias current during runtime based on the actual chip temperature

# Initialization
X = rd @0xCE          # read the original value of the register 0xCE and store it into the variable X

# Runtime
T = rd 'temperature' # read the current chip temperature and find the compensation value 'nn'
Y = X add 0x'nn'      # add the compensation value (from table above)
wr @0xCE = Y
```

## 16. Addendum

### 16.1. Terms, definitions and abbreviations

Abbreviation	Term, Definition	Explanation
ABS	Automatic Backlight Suppression	
ADC	Analog Digital Converter	
AMR	Ratio of ambient-light / modulated light	
CGU	Clock Generation Unit	
CSP	Chip Scale Package	
DCS	Differential Correlation Sample	
DLL	Delay Locked Loop	Delay line only in the implementation of epc660
fps	Frames per second	
Half-QQVGA	1/8 of a Quarter VGA	160x60 pixel resolution
HDR	High Dynamic Range	
IC	Integrated Circuit	
LED/LD	Light Emitting Diode / Laser Diode	
LSB	Least Significant Bit	
MGA	Modulation Gate A	
MGB	Modulation Gate B	
MGX	Modulation Gate A or B	
mga	MGA control signal	
mgb	MGB control signal	
mgx	MGX control signal	
MSB	Most Significant Bit	
OSC	Oscillator	
PLL	Phase Locked Loop	
ROI	Region of Interest	
QVGA	Quarter VGA	320x240 pixel resolution
SGA	Storage Gate A	
SGB	Storage Gate B	
SGX	Storage Gate A or B	
TCMI	TOF Camera Module Interface	
TOF	Time of Flight	
VGA	Video Graphics Array	640x480 pixel resolution
XTAL	Crystal	

Table 37: Definitions and abbreviations

### 16.2. Related documents

- 3D-TOF, A guideline to 3D-TOF sensors that work, Beat De Coi, ISBN 978-3-033-07096-7.
- Application note AN08 Process-Rules CSP Assembly, ESPROS Photonics corp.
- Application note AN10 Calibration and compensation of Cameras using ESPROS TOF Chips, ESPROS Photonics corp.
- Application note AN11 DME 660 Photobiological Safety Analysis, ESPROS Photonics Corp.
- Application note AN12 TOF data improvement toolbox, ESPROS Photonics Corp.
- NXP I<sup>2</sup>C-bus specification: I<sup>2</sup>C Bus Specification and User Manual, NXP corp.

## 17. IMPORTANT NOTICE

ESPROS Photonics AG and its subsidiaries (ESPROS) reserve the right to make corrections, modifications, enhancements, improvements, and other changes to its products and services at any time and to discontinue any product or service without notice. Customers should obtain the latest relevant information before placing orders and should verify that such information is current and complete. All products are sold subject to ESPROS' terms and conditions of sale supplied at the time of order acknowledgment.

ESPROS warrants performance of its hardware products to the specifications applicable at the time of sale in accordance with ESPROS' standard warranty. Testing and other quality control techniques are used to the extent ESPROS deems necessary to support this warranty. Except where mandated by government requirements, testing of all parameters of each product is not necessarily performed.

ESPROS assumes no liability for applications assistance or customer product design. Customers are responsible for their products and applications using ESPROS components. To minimize the risks associated with customer products and applications, customers should provide adequate design and operating safeguards.

ESPROS does not warrant or represent that any license, either express or implied, is granted under any ESPROS patent right, copyright, mask work right, or other ESPROS intellectual property right relating to any combination, machine, or process in which ESPROS products or services are used. Information published by ESPROS regarding third-party products or services does not constitute a license from ESPROS to use such products or services or a warranty or endorsement thereof. Use of such information may require a license from a third party under the patents or other intellectual property of the third party, or a license from ESPROS under the patents or other intellectual property of ESPROS.

Resale of ESPROS products or services with statements different from or beyond the parameters stated by ESPROS for that product or service voids all express and any implied warranties for the associated ESPROS product or service. ESPROS is not responsible or liable for any such statements.

ESPROS products are not authorized for use in safety-critical applications (such as life support) where a failure of the ESPROS product would reasonably be expected to cause severe personal injury or death, unless officers of the parties have executed an agreement specifically governing such use. Buyers represent that they have all necessary expertise in the safety and regulatory ramifications of their applications, and acknowledge and agree that they are solely responsible for all legal, regulatory and safety-related requirements concerning their products and any use of ESPROS products in such safety-critical applications, notwithstanding any applications-related information or support that may be provided by ESPROS. Further, Buyers must fully indemnify ESPROS and its representatives against any damages arising out of the use of ESPROS products in such safety-critical applications.

ESPROS products are neither designed nor intended for use in military/aerospace applications or environments unless the ESPROS products are specifically designated by ESPROS as military-grade. Only products designated by ESPROS as military-grade meet military specifications. Buyers acknowledge and agree that any such use of ESPROS products which ESPROS has not designated as military-grade is solely at the Buyer's risk, and that they are solely responsible for compliance with all legal and regulatory requirements in connection with such use.

ESPROS products are neither designed nor intended for use in automotive applications or environments unless the specific ESPROS products are designated by ESPROS as compliant with ISO/TS 16949 requirements. Buyers acknowledge and agree that, if they use any non-designated products in automotive applications, ESPROS will not be responsible for any failure to meet such requirements.