

MAX6078A/MAX6078B

Low-Power, Low-Drift, Low-Noise Voltage Reference

General Description

The MAX6078 precision voltage reference family provides low drift and low noise at a maximum power supply current of only 15 μ A. Low-frequency noise is less than 12 μ V_{P-P} (2.5V output voltage option) and the temperature coefficient of the output voltage is less than 10ppm/ $^{\circ}$ C.

The reference output can sink and source up to 3mA of load current and the top grade provides an initial accuracy of 0.04%. The low-drift and low-noise specifications enable enhanced system accuracy, making these devices ideal for high-precision industrial applications. A noise reduction (NR) input pin allows connection of an external capacitor to reduce wideband noise. Available output voltages include 1.25V, 2.048V, 2.5V, 3.0V, 3.3V, 4.096V, and 5.0V.

The tiny, 6-bump WLP and small, 8-pin TDFN-EP packages are suitable for systems where circuit board area is limited. The operating input voltage can range from 2.3V to 5.5V. Operation is specified over the extended industrial temperature range of -55 $^{\circ}$ C to +125 $^{\circ}$ C.

Applications

- High-Accuracy Industrial and Process Control
- Precision Instrumentation
- High-Resolution ADCs and DACs
- Portable and Handheld Systems

Benefits and Features

- $\pm 0.04\%$ Initial Accuracy
- 10ppm/ $^{\circ}$ C (max) Temperature Drift
- 12 μ V_{P-P} Noise (0.1Hz to 10Hz) at 2.5V
- 15 μ A Supply Current
- Long-Term Drift: 16ppm (typ, 4000hrs)
- 3mA Source/Sink Load Current
- Filter Option Reduces High-Frequency Noise
- 100mV Dropout Voltage
- 1.5mm x 1.3mm (0.5mm pitch), 6-Bump WLP and 2mm x 3mm, 8-Pin TDFN-EP Packages
- Voltage Output Options: 1.25V, 2.048V, 2.5V, 3.0V, 3.3V, 4.096V, and 5.0V

Ordering Information appears at end of data sheet.

Simplified Block Diagram

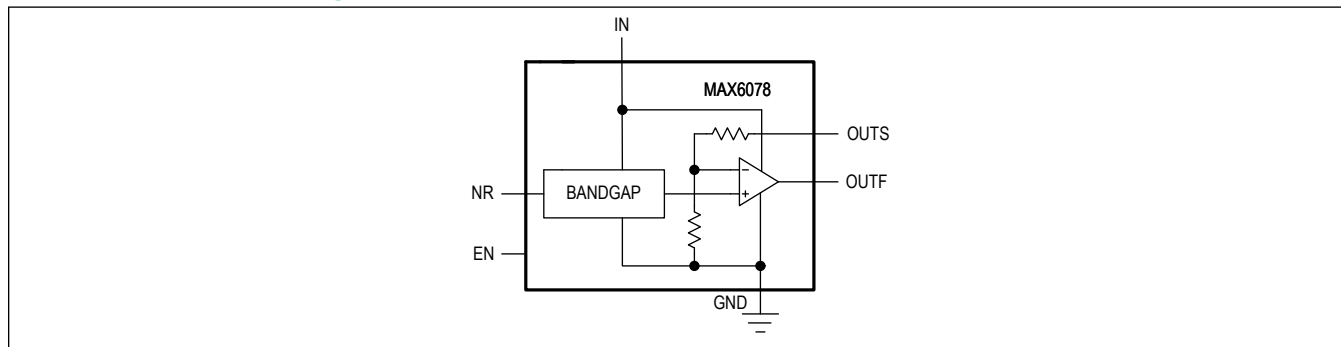

TABLE OF CONTENTS

General Description	1
Applications	1
Benefits and Features	1
Simplified Block Diagram	1
Absolute Maximum Ratings	4
Package Information	4
8 TDFN	4
8 WLP	4
Electrical Characteristics – 2.5V	4
Electrical Characteristics – 3.0V	6
Electrical Characteristics – 3.3V	7
Typical Operating Characteristics	9
Pin Configurations	12
6 WLP	12
8 TDFN-EP	12
Pin Description	13
Typical Operating Circuit	13
Detailed Description	14
Wideband Noise Reduction (NR)	14
Output Bypassing	14
Turn-On Time	14
Output Force and Sense	14
Shutdown	14
Thermal Hysteresis	14
Applications Information	15
Precision Current Source	15
Ordering Information	16
Revision History	17

LIST OF FIGURES

Figure 1. Noise Reduction Capacitor	14
Figure 2. Precision Current Source	15

Absolute Maximum Ratings

OUTF to GND.....	-0.3V to (V _{IN} + 0.3)V	Maximum Continuous Power Dissipation (T _A = +70°C) .
OUTS to GND.....	-0.3V to +6V	TDFN (derate 16.7mW/°C above +70°C).....
IN to GND.....	-0.3V to +6V	WLP (derate 12.34mW/°C above +70°C).....
EN to GND.....	-0.3V to +6V	Operating Temperature Range
NR to GND	-0.3V to (V _{IN} + 0.3)V	Storage Temperature Range
Current to/from OUTF.....	50mA	Lead Temperature (soldering, 10s).....
Current to/from OUTS/NR/EN	20mA	Soldering Temperature (reflow)

Stresses beyond those listed under "Absolute Maximum Ratings" may cause permanent damage to the device. These are stress ratings only, and functional operation of the device at these or any other conditions beyond those indicated in the operational sections of the specifications is not implied. Exposure to absolute maximum rating conditions for extended periods may affect device reliability.

Package Information

8 TDFN

Package Code	T823+1C
Outline Number	21-0174
Land Pattern Number	90-0091
Thermal Resistance, Four-Layer Board	
Junction to Ambient (θ _{JA})	60°C/W
Junction to Case (θ _{JC})	11°C/W

8 WLP

Package Code	W61L1+1
Outline Number	21-100365
Land Pattern Number	Refer to Application Note 1891
Thermal Resistance, Four-Layer Board	
Junction to Ambient (θ _{JA})	81.03°C/W
Junction to Case (θ _{JC})	N/A

For the latest package outline information and land patterns (footprints), go to www.maximintegrated.com/packages. Note that a "+", "#", or "-" in the package code indicates RoHS status only. Package drawings may show a different suffix character, but the drawing pertains to the package regardless of RoHS status.

Package thermal resistances were obtained using the method described in JEDEC specification JESD51-7, using a four-layer board. For detailed information on package thermal considerations, refer to www.maximintegrated.com/thermal-tutorial.

Electrical Characteristics – 2.5V

(V_{IN} = +3.3V, I_{OUT} = 0mA, C_{OUT} = 0.1µF, T_A = -55°C to +125°C, unless otherwise specified. Typical values are at T_A = +25°C (*Note 1*))

PARAMETER	SYMBOL	CONDITIONS	MIN	TYP	MAX	UNITS
Output Voltage Accuracy		T _A = +25°C	-0.04		+0.04	%
Output Voltage Temperature Drift	TCV _{OUT}	-40°C to +125°C (<i>Note 2</i>)		2	10	ppm/°C
		-55°C to +125°C (<i>Note 2</i>)		2	10	

Electrical Characteristics – 2.5V (continued)

($V_{IN} = +3.3V$, $I_{OUT} = 0mA$, $C_{OUT} = 0.1\mu F$, $T_A = -55^\circ C$ to $+125^\circ C$, unless otherwise specified. Typical values are at $T_A = +25^\circ C$ ([Note 1](#)))

PARAMETER	SYMBOL	CONDITIONS		MIN	TYP	MAX	UNITS
Line Regulation		Over specified operating input voltage range			10	175	$\mu V/V$
Load Regulation		$-3mA \leq I_{OUT} \leq +3mA$			5	125	$\mu V/mA$
Dropout Voltage		$I_{OUT} = 3mA$ (Note 3)				100	mV
		$I_{OUT} = 100\mu A$ (Note 3)				10	
Output Current	I_{OUT}	Guaranteed by load regulation		-3		+3	mA
Short-Circuit Current	I_{SC}	Sourcing to ground			36		mA
		Sinking current from V_{IN}			24		
Long-Term Stability		$T_A = +35^\circ C$	0 to 4000hrs		16		ppm
			0 to 1000hrs		9.8		
			1000hrs to 2000hrs		2.5		
			2000hrs to 3000hrs		1.89		
			3000hrs to 4000hrs		1.96		
Thermal Hysteresis		(Note 4)			20		ppm
Output Noise Voltage	e_{OUT}	0.1Hz to 10Hz, $C_{OUT} = 0.1\mu F$			12		μV_{P-P}
		10Hz to 10kHz, $C_{OUT} = 0.1\mu F$			30		μV_{RMS}
		10Hz to 10kHz, $C_{OUT} = 0.1\mu F$, $C_{NR} = 0.01\mu F$			20		
Output Noise Spectral Density		$f = 100Hz$, $C_{OUT} = 0.1\mu F$			580		nV/\sqrt{Hz}
		$f = 100Hz$, $C_{OUT} = 0.1\mu F$, $C_{NR} = 0.01\mu F$			385		
Ripple Rejection		$f = 60Hz$			50		dB
Turn-On Settling Time		Settling to 0.1%, $C_{OUT} = 0.1\mu F$	$C_{NR} = 0.01\mu F$		50		ms
		Settling to 0.1%, $C_{OUT} = 0.1\mu F$	No C_{NR}		5		
Enable Settling Time	t_{EN}	Settling to 0.1%, $C_{OUT} = 0.1\mu F$	$C_{NR} = 0.01\mu F$		30		ms
		Settling to 0.1%, $C_{OUT} = 0.1\mu F$	No C_{NR}		3		
Capacitive-Load Stability Range				0.1		4.7	μF
Supply Voltage	V_{IN}			2.7		5.5	V

Electrical Characteristics – 2.5V (continued)

($V_{IN} = +3.3V$, $I_{OUT} = 0mA$, $C_{OUT} = 0.1\mu F$, $T_A = -55^\circ C$ to $+125^\circ C$, unless otherwise specified. Typical values are at $T_A = +25^\circ C$ ([Note 1](#)))

PARAMETER	SYMBOL	CONDITIONS	MIN	TYP	MAX	UNITS
Quiescent Supply Current	I_{IN}	$V_{IN} = 5V$	$T_A = +25^\circ C$	10	15	μA
			$T_A = -55^\circ C$ to $+85^\circ C$		16.5	
			$T_A = -55^\circ C$ to $+125^\circ C$		18	
		$V_{IN} = 3.3V$	$T_A = +25^\circ C$	9	14	
			$T_A = -55^\circ C$ to $+85^\circ C$		15.5	
			$T_A = -55^\circ C$ to $+125^\circ C$		17	
Shutdown Supply Current	I_{SD}		0.1	2	μA	
Enable Input Current	I_{EN}			0.1	μA	
Enable Logic-High	V_{IH}		$0.7 \times V_{IN}$		V	
Enable Logic-Low	V_{IL}			$0.3 \times V_{IN}$	V	

Electrical Characteristics – 3.0V

($V_{IN} = +5V$, $I_{OUT} = 0mA$, $C_{OUT} = 0.1\mu F$, $T_A = -55^\circ C$ to $+125^\circ C$, unless otherwise specified. Typical values are at $T_A = +25^\circ C$ ([Note 1](#)))

PARAMETER	SYMBOL	CONDITIONS	MIN	TYP	MAX	UNITS
Output Voltage Accuracy		$T_A = +25^\circ C$	-0.04		+0.04	%
Output Voltage Temperature Drift	TCV_{OUT}	$-40^\circ C$ to $+125^\circ C$ (Note 2)		2	10	ppm/ $^\circ C$
		$-55^\circ C$ to $+125^\circ C$ (Note 2)		2	10	
Line Regulation		Over specified operating input voltage range		10	175	$\mu V/V$
Load Regulation		$-3mA \leq I_{OUT} \leq +3mA$		5	125	$\mu V/mA$
Dropout Voltage		$I_{OUT} = 3mA$ (Note 3)			100	mV
		$I_{OUT} = 100\mu A$ (Note 3)			10	
Output Current	I_{OUT}	Guaranteed by load regulation	-3		+3	mA
Short-Circuit Current	I_{SC}	Sourcing to ground		36		mA
		Sinking current from V_{IN}		24		
Long-Term Stability		$T_A = +35^\circ C$	0 to 4000hrs	16		ppm
			0 to 1000hrs	9.8		
			1000hrs to 2000hrs	2.5		
			2000hrs to 3000hrs	1.89		
			3000hrs to 4000hrs	1.96		
Thermal Hysteresis		(Note 4)		20		ppm

Electrical Characteristics – 3.0V (continued)(V_{IN} = +5V, I_{OUT} = 0mA, C_{OUT} = 0.1μF, T_A = -55°C to +125°C, unless otherwise specified. Typical values are at T_A = +25°C ([Note 1](#)))

PARAMETER	SYMBOL	CONDITIONS		MIN	TYP	MAX	UNITS
Output Noise Voltage	e _{OUT}	0.1Hz to 10Hz, C _{OUT} = 0.1μF			12		μV _{P-P}
		10Hz to 10kHz, C _{OUT} = 0.1μF			30		μV _{RMS}
		10Hz to 10kHz, C _{OUT} = 0.1μF, C _{NR} = 0.01μF			20		
Output Noise Spectral Density		f = 100Hz, C _{OUT} = 0.1μF			580		nV/√Hz
		f = 100Hz, C _{OUT} = 0.1μF, C _{NR} = 0.01μF			385		
Ripple Rejection		f = 60Hz			50		dB
Turn-On Settling Time		Settling to 0.1%, C _{OUT} = 0.1μF	C _{NR} = 0.01μF		50		ms
		Settling to 0.1%, C _{OUT} = 0.1μF	No C _{NR}		5		
Enable Settling Time	t _{EN}	Settling to 0.1%, C _{OUT} = 0.1μF	C _{NR} = 0.01μF		30		ms
		Settling to 0.1%, C _{OUT} = 0.1μF	No C _{NR}		3		
Capacitive-Load Stability Range				0.1		4.7	μF
Supply Voltage	V _{IN}			3.2		5.5	V
Quiescent Supply Current	I _{IN}	T _A = +25°C			10	15	μA
		T _A = -55°C to +85°C				16.5	
		T _A = -55°C to +125°C				18	
Shutdown Supply Current	I _{SD}				0.1	2	μA
Enable Input Current	I _{EN}					0.1	μA
Enable Logic-High	V _{IH}			0.7 x V _{IN}			V
Enable Logic-Low	V _{IL}					0.3 x V _{IN}	V

Electrical Characteristics – 3.3V(V_{IN} = +5V, I_{OUT} = 0mA, C_{OUT} = 0.1μF, T_A = -55°C to +125°C, unless otherwise specified. Typical values are at T_A = +25°C ([Note 1](#)))

PARAMETER	SYMBOL	CONDITIONS		MIN	TYP	MAX	UNITS
Output Voltage Accuracy		T _A = +25°C		-0.04		+0.04	%
Output Voltage Temperature Drift	TCV _{OUT}	-40°C to +125°C (Note 2)			2	10	ppm/°C
		-55°C to +125°C (Note 2)			2	10	
Line Regulation		Over specified operating input voltage range			10	175	μV/V
Load Regulation		-3mA ≤ I _{OUT} ≤ +3mA			5	125	μV/mA
Dropout Voltage		I _{OUT} = 3mA (Note 3)				100	mV
		I _{OUT} = 100μA (Note 3)				10	
Output Current	I _{OUT}	Guaranteed by load regulation		-3		+3	mA

Electrical Characteristics – 3.3V (continued)

(V_{IN} = +5V, I_{OUT} = 0mA, C_{OUT} = 0.1μF, T_A = -55°C to +125°C, unless otherwise specified. Typical values are at T_A = +25°C (*Note 1*))

PARAMETER	SYMBOL	CONDITIONS		MIN	TYP	MAX	UNITS
Short-Circuit Current	I _{SC}	Sourcing to ground			36		mA
		Sinking current from V _{IN}			24		
Long-Term Stability		T _A = +35°C	0 to 4000hrs		16		ppm
			0 to 1000hrs		9.8		
			1000hrs to 2000hrs		2.5		
			2000hrs to 3000hrs		1.89		
			3000hrs to 4000hrs		1.96		
Thermal Hysteresis		<i>(Note 4)</i>			20		ppm
Output Noise Voltage	e _{OUT}	0.1Hz to 10Hz, C _{OUT} = 0.1μF			12		μV _{P-P}
		10Hz to 10kHz, C _{OUT} = 0.1μF			30		μV _{RMS}
		10Hz to 10kHz, C _{OUT} = 0.1μF, C _{NR} = 0.01μF			20		
Output Noise Spectral Density		f = 100Hz, C _{OUT} = 0.1μF			580		nV/√Hz
		f = 100Hz, C _{OUT} = 0.1μF, C _{NR} = 0.01μF			385		
Ripple Rejection		f = 60Hz			50		dB
Turn-On Settling Time		Settling to 0.1%, C _{OUT} = 0.1μF	C _{NR} = 0.01μF		50		ms
		Settling to 0.1%, C _{OUT} = 0.1μF	No C _{NR}		5		
Enable Settling Time	t _{EN}	Settling to 0.1%, C _{OUT} = 0.1μF	C _{NR} = 0.01μF		30		ms
		Settling to 0.1%, C _{OUT} = 0.1μF	No C _{NR}		3		
Capacitive-Load Stability Range				0.1		4.7	μF
Supply Voltage	V _{IN}			3.5		5.5	V
Quiescent Supply Current	I _{IN}	T _A = +25°C			10	15	μA
		T _A = -40°C to +125°C				16.5	
		T _A = -55°C to +125°C				18	
Shutdown Supply Current	I _{SD}				0.1	2	μA
Enable Input Current	I _{EN}					0.1	μA
Enable Logic-High	V _{IH}			0.7 x V _{IN}			V
Enable Logic-Low	V _{IL}					0.3 x V _{IN}	V

Note 1: Limits are 100% tested at T_A = +25°C. Limits over the operating temperature range and relevant supply voltage range are guaranteed by design and characterization.

Note 2: Temperature coefficient is calculated using the “box method” which measures temperature drift as the maximum voltage variation over a specified temperature range.

Note 3: Dropout voltage is defined as the minimum differential voltage (V_{IN} - V_{OUT}) at which V_{OUT} decreases by 0.2% from its original value. V_{IN} = 3.3V for output voltages of 1.25V, 2.048V, and 2.5V; V_{IN} = 5V for output voltages of 3V, 3.3V, 4.096V; V_{IN} = 5.5V for output voltage of 5V.

Note 4: Thermal hysteresis is defined as the change in +25°C output voltage before and after cycling the device from T_{MAX} to T_{MIN}.

Typical Operating Characteristics

($V_{IN} = 3.3V$, $I_{OUT} = 0mA$, $C_{OUT} = 0.1\mu F$ to GND, $T_A = +25^\circ C$, unless otherwise noted.)

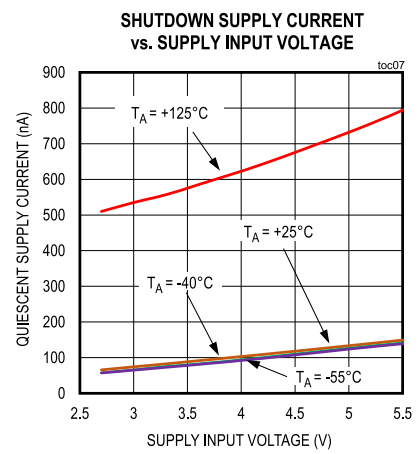
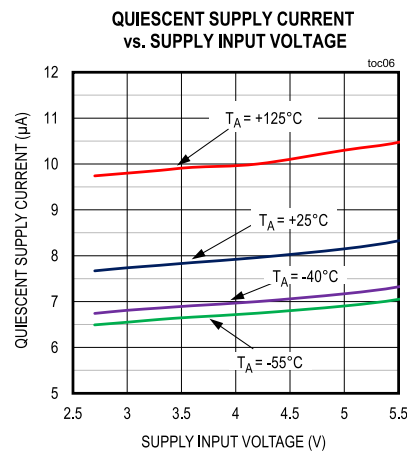
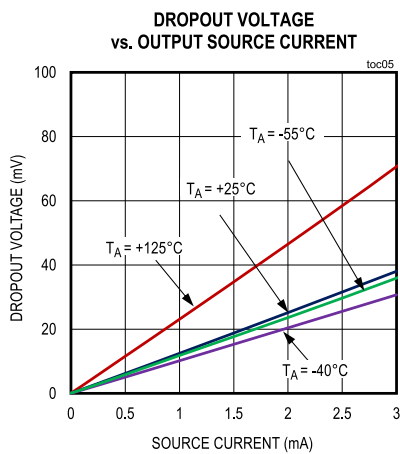
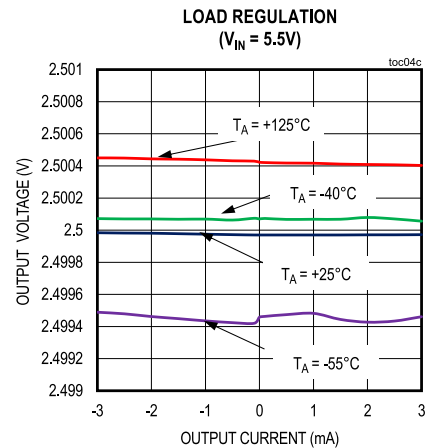
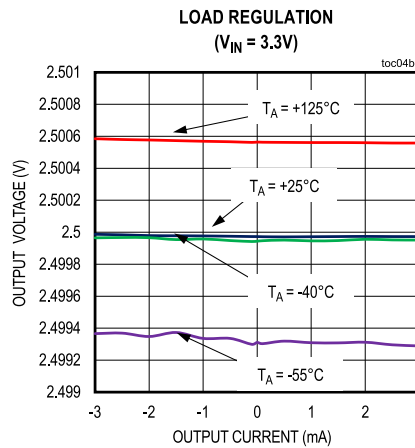
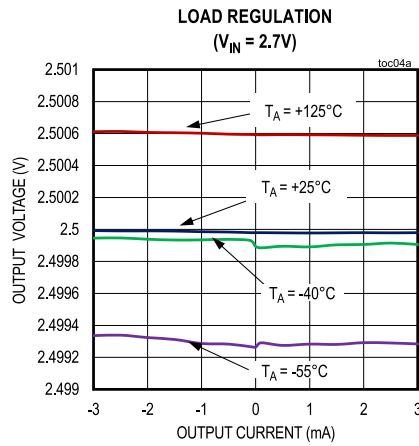
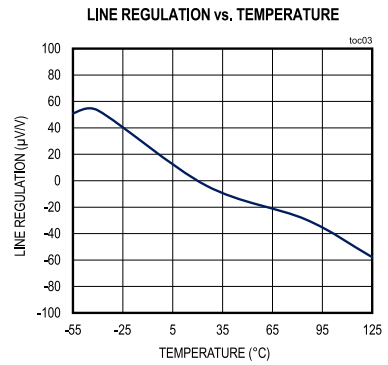
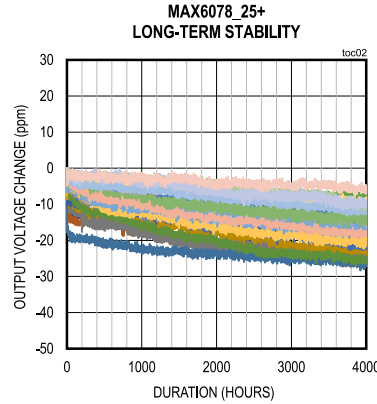
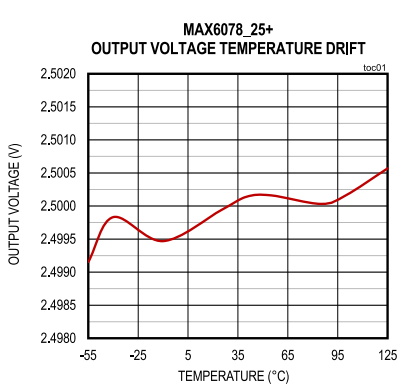

Typical Operating Characteristics (continued)

($V_{IN} = 3.3V$, $I_{OUT} = 0mA$, $C_{OUT} = 0.1\mu F$ to GND, $T_A = +25^\circ C$, unless otherwise noted.)

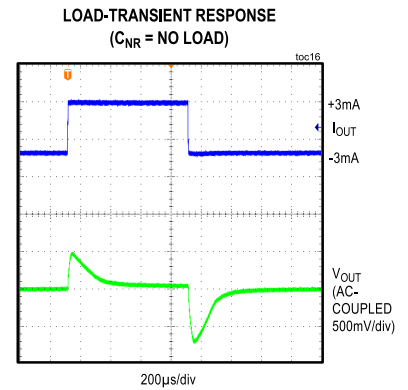
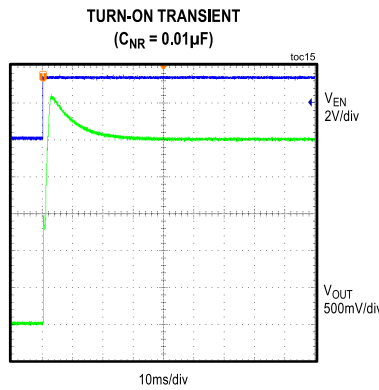
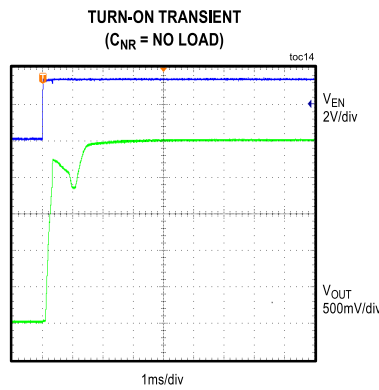
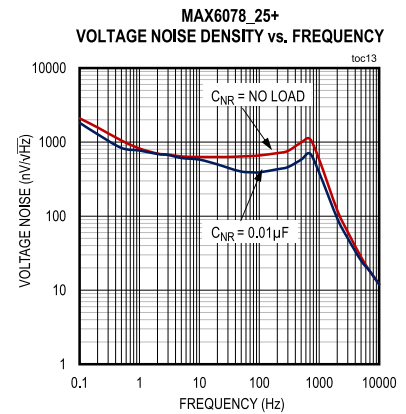
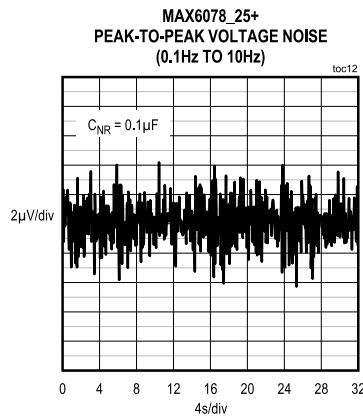
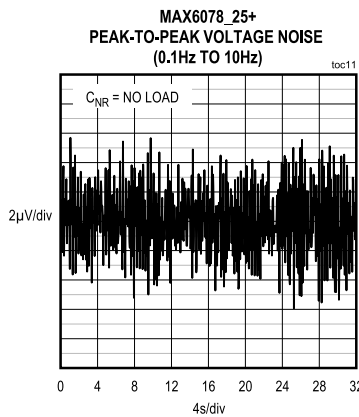
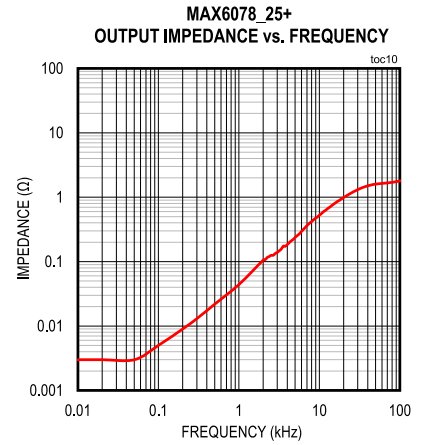
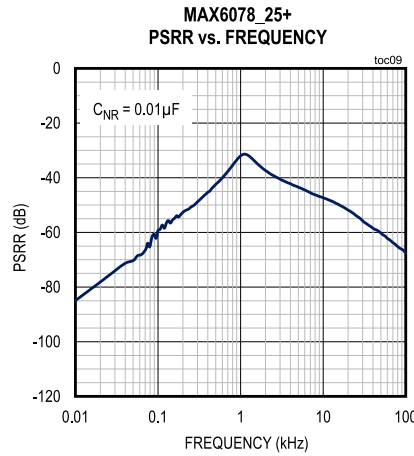
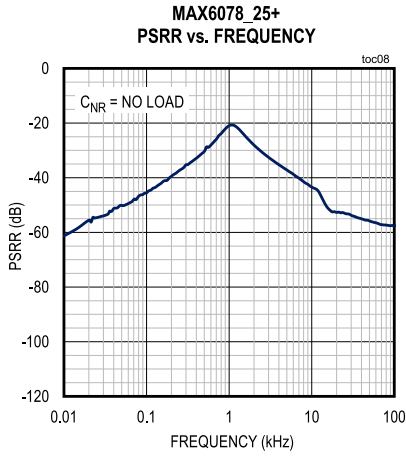

Typical Operating Characteristics (continued)

($V_{IN} = 3.3V$, $I_{OUT} = 0mA$, $C_{OUT} = 0.1\mu F$ to GND, $T_A = +25^\circ C$, unless otherwise noted.)

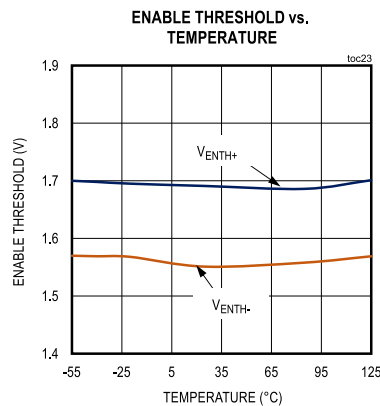
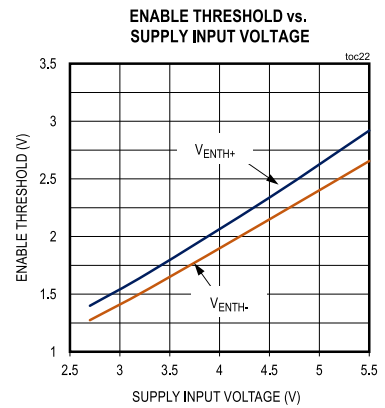
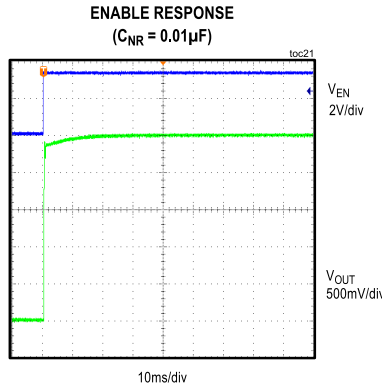
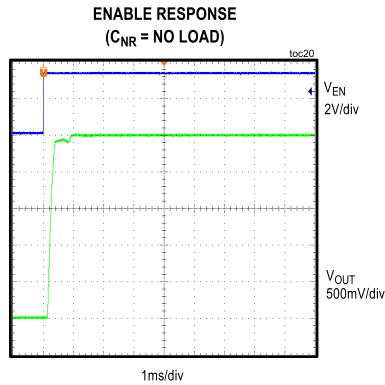
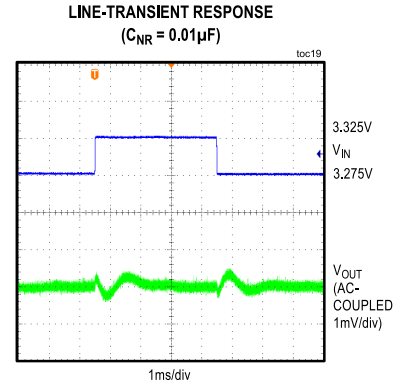
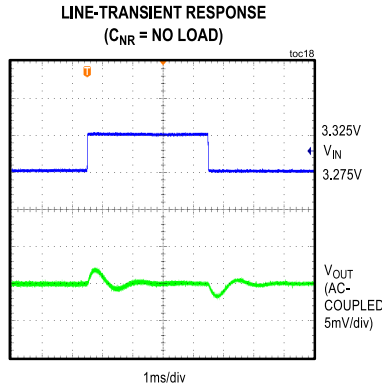
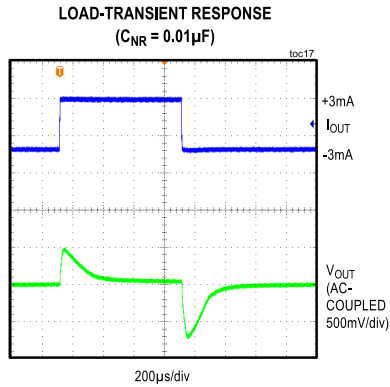

Pin Configurations

6 WLP

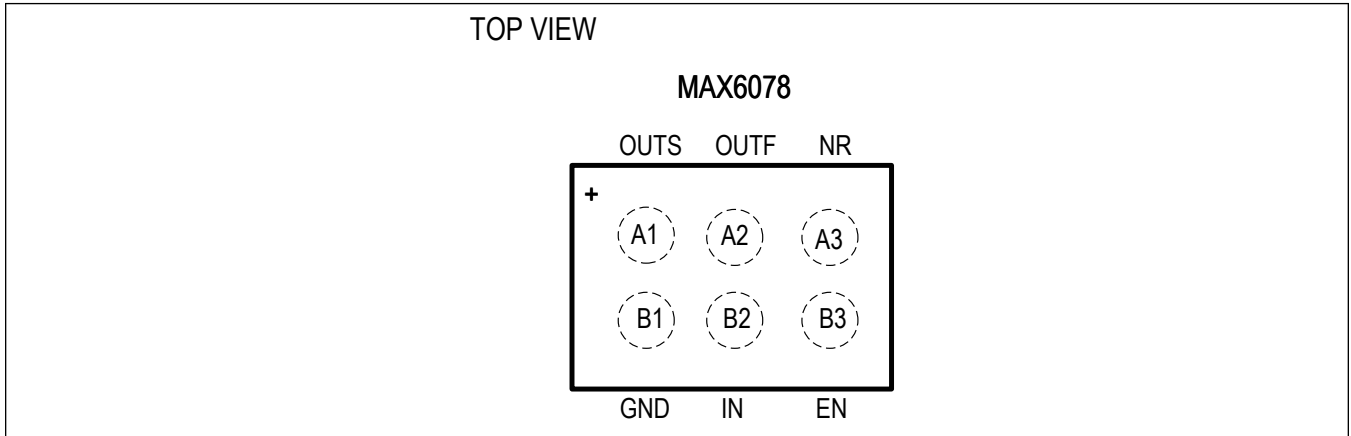

8 TDFN-EP

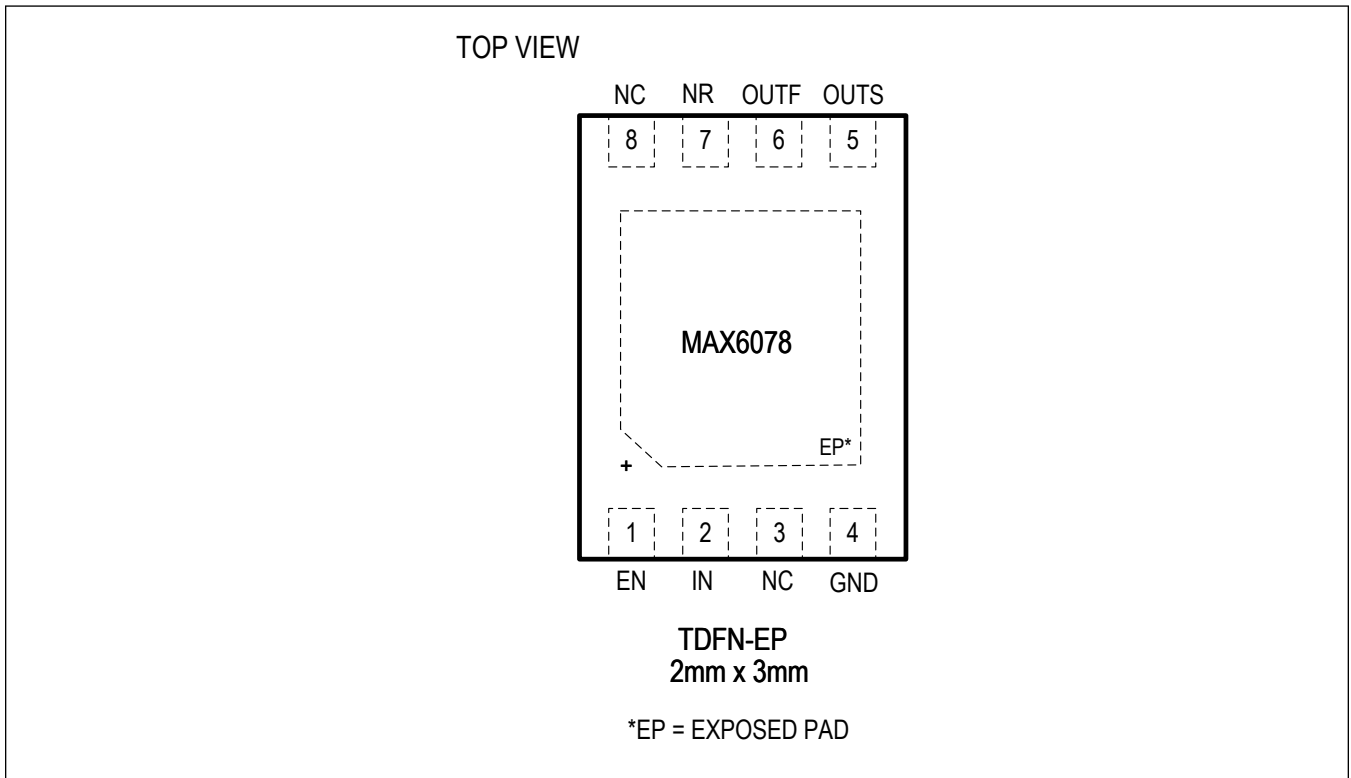

Pin Description

PIN		NAME	FUNCTION
6 WLP	8 TDFN-EP		
A1	5	OUTS	Voltage Reference Output Sense. Connect OUTF and OUTS as close as possible to the load.
A2	6	OUTF	Voltage Reference Force Output. Connect OUTF and OUTS as close as possible to the load. Bypass OUTF with a capacitor to GND.
A3	7	NR	Noise Reduction Input. Connect a 0.01 μ F capacitor from NR to ground to provide wideband noise filtering. Leave unconnected if not used.
B1	4	GND	Ground
B2	2	IN	Supply Input
B3	1	EN	Enable. Drive high to enable. Drive low to disable.
—	3, 8	NC	No Connect. Not internally connected. May be connected to GND.
—	EP	EP	Exposed Pad. EP is internally connected to GND. Connect EP to GND.

Typical Operating Circuit

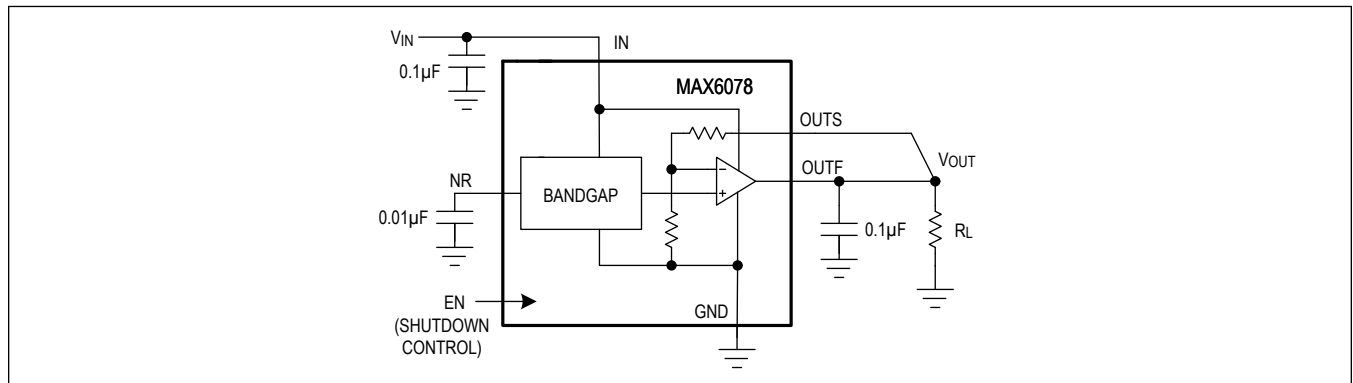

Detailed Description

Wideband Noise Reduction (NR)

To improve wideband noise and transient power supply noise, connect a $0.01\mu\text{F}$ capacitor from NR to GND (see the [Typical Operating Characteristics](#)). Larger values do not appreciably improve noise reduction. A $0.01\mu\text{F}$ capacitor reduces the spectral noise density at 100Hz from $580\text{nV}/\sqrt{\text{Hz}}$ to $385\text{nV}/\sqrt{\text{Hz}}$ for the 2.5V output version. Noise at the input pin can affect output noise, but can be reduced by connecting an optional bypass capacitor between IN and GND, as shown in [Figure 1](#).

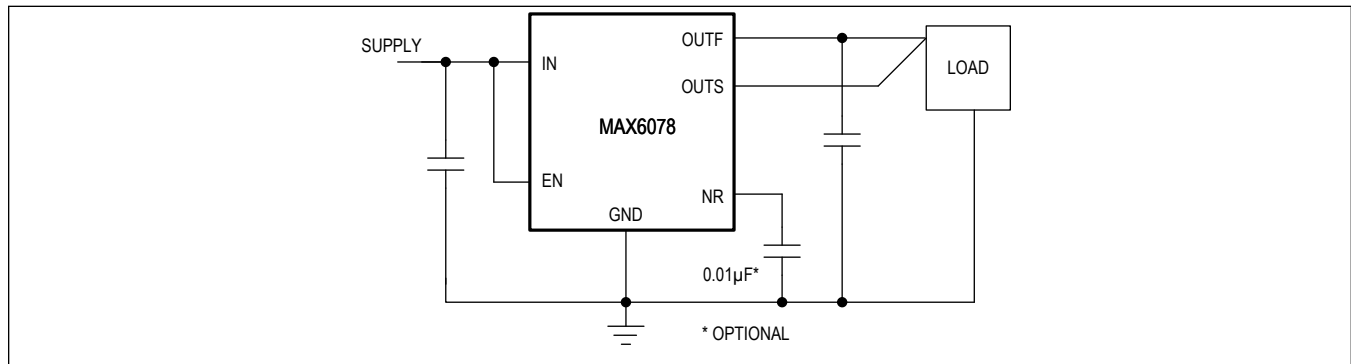

Figure 1. Noise Reduction Capacitor

Output Bypassing

Use an output capacitor with a value between $0.1\mu\text{F}$ and $4.7\mu\text{F}$. Place the output capacitor as close to **OUTF** as possible. For applications driving switching capacitive loads or rapidly changing load currents, use a $0.1\mu\text{F}$ capacitor in parallel with a larger load capacitor to reduce equivalent series resistance (ESR). Larger capacitor values and lower ESR reduce transients on the reference output.

Turn-On Time

These references typically turn on and settle to within 0.1% of their final value in 5ms with no capacitive loads at **NR** pin. A $0.1\mu\text{F}$ load capacitor at **OUTF** and a $0.01\mu\text{F}$ noise reduction capacitor connected to the **NR** input increase the turn-on time to approximately 50ms.

Output Force and Sense

These references provide independent connections for the force output (**OUTF**), which supplies current to the load and the feedback input that regulates the load voltage through the output sense pin (**OUTS**). This configuration allows for the cancellation of the voltage drop on the lines connecting the reference to the load. Connect **OUTF** to the load and connect **OUTS** to **OUTF** at the point where the voltage accuracy is needed ([Figure 1](#)).

Shutdown

Although the operating power supply current of these references is very low, there are some cases that require even lower supply current during shutdown conditions. Pulling **EN** low disables the output with an internal resistive load to ground and forces the quiescent current to less than 100nA. Pulling **EN** high enables normal operation. The return to normal operation occurs within the 3ms enable time delay typically.

Thermal Hysteresis

Thermal hysteresis is the change of output voltage at $T_A = +25^\circ\text{C}$ before and after the device is cycled over its entire operating temperature range. The typical thermal hysteresis value is 20ppm.

Applications Information

Precision Current Source

[Figure 2](#) shows a precision current source. The OUTF output provides the bias current for the bipolar transistor. OUTS and GND sense the voltage across the resistor and adjust the current sourced by OUTF accordingly. The voltage range of OUTF is set by the reference output voltage (OUTS) and the V_{BE} (BJT) of the output external device:

$$V_{OUTF} = V_{BE} + V_{REF}$$

where:

V_{OUTF} is the voltage on the OUTF pin,

V_{BE} is the base-emitter drop across BJT,

V_{REF} is the actual voltage reference output this part is supposed to provide.

Therefore, the input supply voltage requirement for the MAX6078 is as follows:

$$V_{IN} \geq V_{DROP} (\text{dropout voltage}) + V_{BE\text{max}} + V_{REF}$$

where:

V_{DROP} is the dropout voltage of the voltage reference.

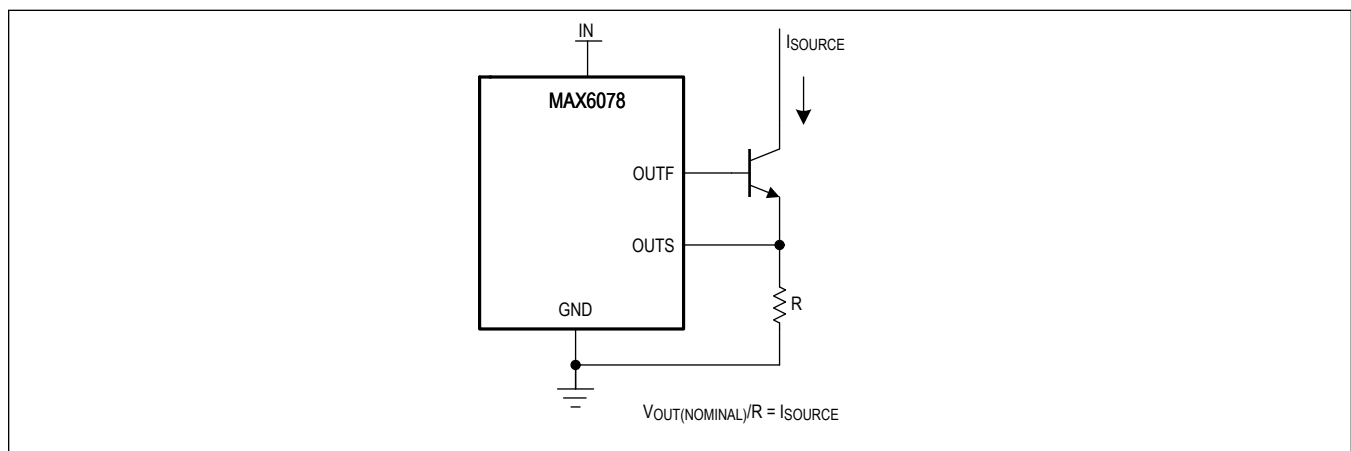

Figure 2. Precision Current Source

Ordering Information

PART NUMBER	TEMP RANGE	PIN-PACKAGE	V _{OUT} (V)	ACCURACY (%)	TOP MARK
MAX6078BMWT12+T*	-55°C to +125°C	6 WLP	1.250	0.04	—
MAX6078AMWT21+T*	-55°C to +125°C	6 WLP	2.048	0.04	—
MAX6078AMWT25+T	-55°C to +125°C	6 WLP	2.500	0.04	+AAE
MAX6078AMWT30+T	-55°C to +125°C	6 WLP	3.000	0.04	+AAH
MAX6078AMWT33+T	-55°C to +125°C	6 WLP	3.300	0.04	+AAI
MAX6078AMWT41+T*	-55°C to +125°C	6 WLP	4.096	0.04	—
MAX6078AMWT50+T*	-55°C to +125°C	6 WLP	5.000	0.04	—
MAX6078BMTA12+T*	-55°C to +125°C	8 TDFN-EP	1.250	0.04	—
MAX6078AMTA21+T*	-55°C to +125°C	8 TDFN-EP	2.048	0.04	—
MAX6078AMTA25+T*	-55°C to +125°C	8 TDFN-EP	2.500	0.04	—
MAX6078AMTA30+T*	-55°C to +125°C	8 TDFN-EP	3.000	0.04	—
MAX6078AMTA33+T*	-55°C to +125°C	8 TDFN-EP	3.300	0.04	—
MAX6078AMTA41+T*	-55°C to +125°C	8 TDFN-EP	4.096	0.04	—
MAX6078AMTA50+T*	-55°C to +125°C	8 TDFN-EP	5.000	0.04	—

+ Denotes a lead(Pb)-free/RoHS-compliant package.

T = Tape and reel.

*Future product—contact factory for availability.

Revision History

REVISION NUMBER	REVISION DATE	DESCRIPTION	PAGES CHANGED
0	6/19	Initial release	—
1	9/20	Updated <i>Benefits and Features</i> , <i>Electrical Characteristics</i> , <i>Typical Operating Characteristics</i> , and <i>Ordering Information</i> table	1, 4, 5, 7–9, 14
2	3/21	Updated the <i>Electrical Characteristics</i> and <i>Ordering Information</i> tables	6–8, 16

For pricing, delivery, and ordering information, please visit Maxim Integrated's online storefront at <https://www.maximintegrated.com/en/storefront/storefront.html>.

Maxim Integrated cannot assume responsibility for use of any circuitry other than circuitry entirely embodied in a Maxim Integrated product. No circuit patent licenses are implied. Maxim Integrated reserves the right to change the circuitry and specifications without notice at any time. The parametric values (min and max limits) shown in the Electrical Characteristics table are guaranteed. Other parametric values quoted in this data sheet are provided for guidance.