

NO.	MASSE / DIMENSION
A	1 3/4-18NS-2A
B	20.6
C	4
D	34.2
E	41.2
F	39.7
G	50.8
H	3.7

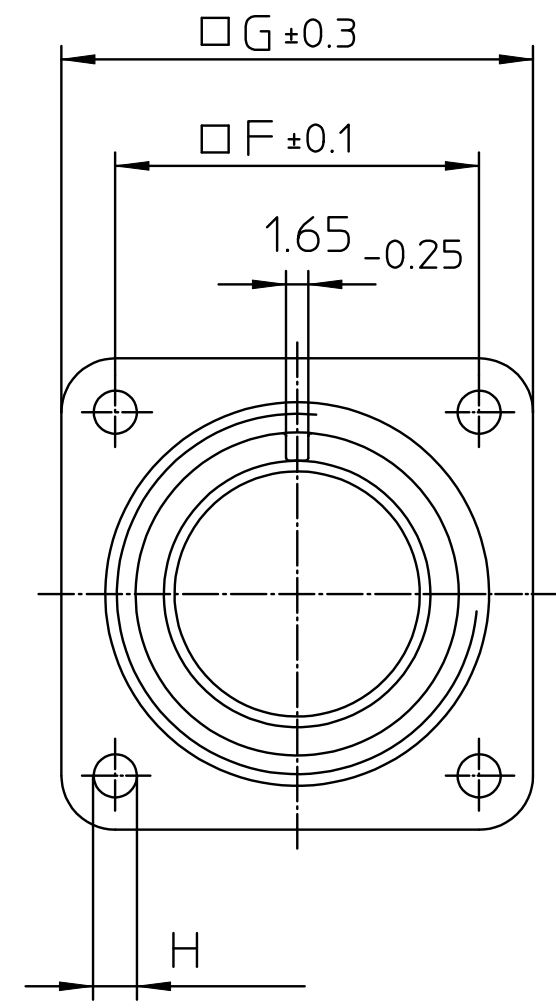

NO.	BESCHREIBUNG / DESCRIPTION
2	ISOLIERKÖRPER BUCHSE / INSULATOR SOCKET
6	KONTAKTBUCHSE / CONTACT SOCKET
8	DOSENGEHÄUSE / SHELL

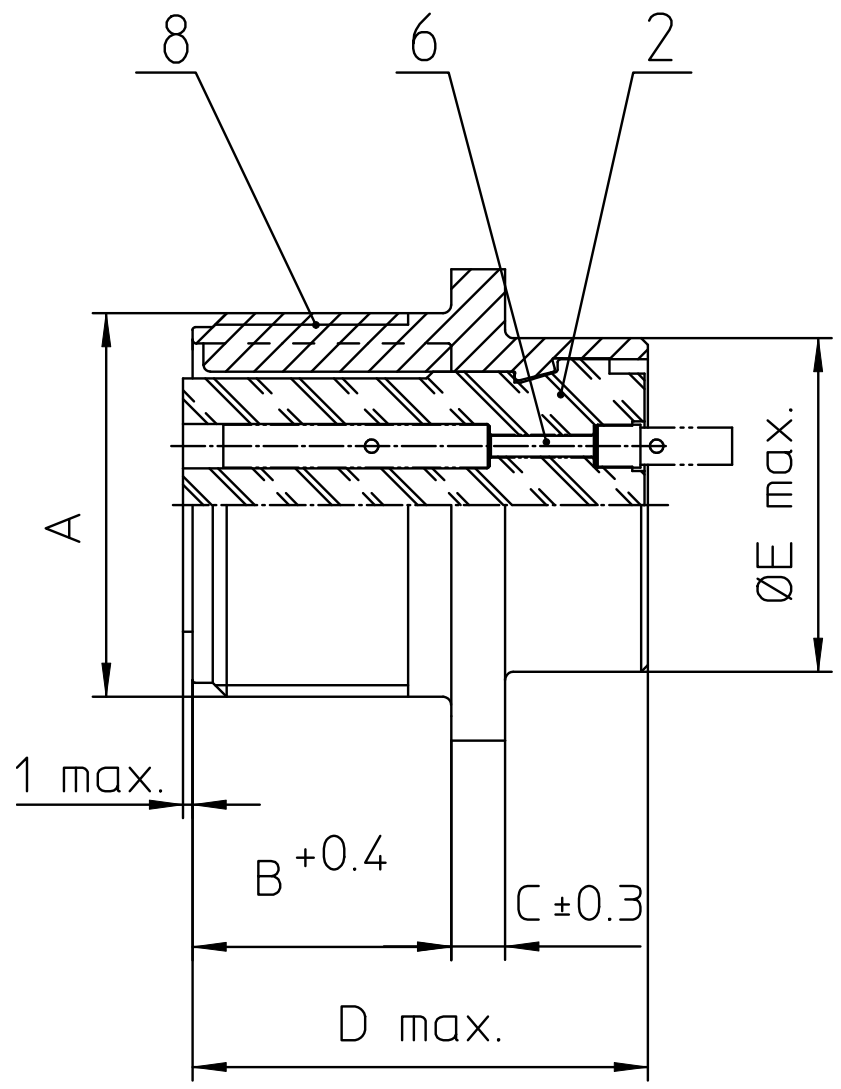
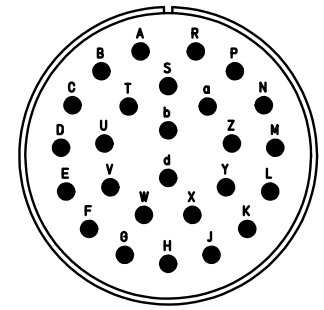

Note: Due to an automatic nomenclature system, numbers generated may not be sequential.
 Specification and Dimensions subject to change
 Drawings illustrate normal insulator positioning

Material Specification:
Shell Material: Aluminium alloy
Shell Plating: Olive drab chromate coating over cadmium plating
Insulator Material: Neoprene
Contact Material: Copper alloy
Contact Plating: Hard silver

all dimensions are in mm
 Dimensions without tolerance indications are general tolerances in acc. with DIN7168m

drawing for CUSTOMER

description CA3102E28-12S-F80
 Box mounting receptacle

AWG Crimp / Socket / Layout: 28-12

Engineered for life
 ITT CANNON GmbH
 D - 71384 Weinstadt/Germany