

# O<sub>2</sub> SENSORS – Zirconium Dioxide (ZrO<sub>2</sub>)

## OXY-Flex Oxygen Analyser User's Guide

---

This document describes the installation, operation and maintenance of the OXY-Flex oxygen analyser.

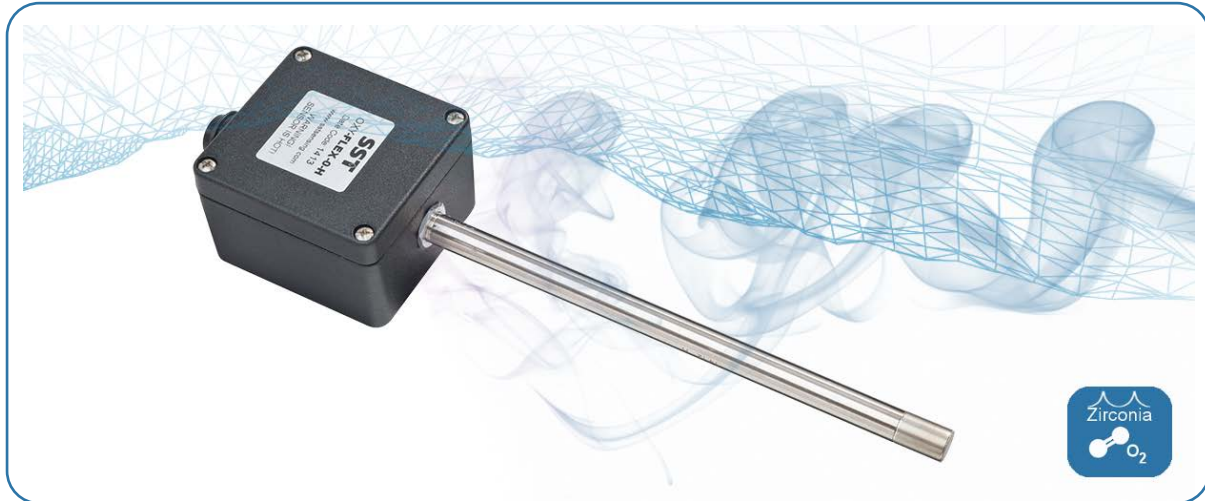

The OXY-Flex analyser designed to determine the oxygen concentration in air or inert gas mixtures in areas that are not easily accessible, or in closed systems, such as ventilation pipes, flues and containers:

- **OXY-Flex-X Series** standard temperature oxygen analyser is designed for use in air or inert gas mixtures with temperatures of -100 to +250°C maximum.
- **OXY-Flex-X-H Series** high temperature oxygen analyser is designed for use in air or inert gas mixtures with temperatures of -100 to +400°C maximum.

The actual oxygen sensor is mounted in the tip of the stainless-steel probe and is protected by a stainless-steel sintered cap which acts as both a large particulate filter and also as a flame trap. The die-cast aluminium housing accommodates the electronics and is mechanically connected to the sensor probe.

## Contents

1	DEFINITIONS.....	1-1
2	SAFETY INSTRUCTIONS.....	2-1
3	TECHNICAL SPECIFICATIONS .....	3-1
4	PRODUCT OVERVIEW.....	4-1
4.1	Main Components.....	4-1
4.2	External Dimensions .....	4-1
5	INSTALLATION .....	5-1
5.1	Mounting Instructions .....	5-1
5.2	Electrical Connections.....	5-2
5.3	System Block Diagram.....	5-3
5.4	PCB Layout .....	5-3
6	INITIAL STARTUP .....	6-1
6.1	Commissioning Checks.....	6-1
6.2	Switching ON.....	6-1
6.3	First-time Calibration .....	6-1
7	SYSTEM CONFIGURATION.....	7-1
7.1	Setting the Output Type.....	7-1
7.2	Setting the Calibration Type and Measurement Range.....	7-2
7.3	Digital Variant – RS232 Output .....	7-3
7.4	Analogue Variants – 0-10V <sub>DC</sub> and 4-20mA Output Values.....	7-6
8	OPERATION .....	8-1
8.1	Operating Tips.....	8-1
8.2	RS232 Operation .....	8-1
9	MAINTENANCE.....	9-1
9.1	Cleaning.....	9-1
9.2	Calibrating .....	9-1
9.3	Error Conditions .....	9-3
9.4	Disposal .....	9-3
	APPENDIX A – MENU STRUCTURE .....	A-1

## 1 DEFINITIONS

The following definitions apply to WARNINGS, CAUTIONS and NOTES used throughout this manual.



### **WARNING:**

The warning symbol is used to indicate instructions that, if they are not followed, can result in minor, serious or even fatal injuries to personnel.



### **CAUTION:**

The caution symbol is used to indicate instructions that, if they are not followed, can result in damage to the equipment (hardware and/or software), or a system failure occurring.

**NOTE:** Highlights an essential operating procedure, condition or statement.

## 2 SAFETY INSTRUCTIONS

- This equipment may only be installed by a suitably qualified technician in accordance with the instructions in this manual and any applicable standards associated with the country or industry.
- Failure to correctly adhere to these instructions may result in serious injury or death and in this regard the manufacturer will not be held liable.
- This equipment may only be operated and maintained by trained technical personnel. The technical personnel must strictly adhere to the instructions given in this manual, and any prevailing standards/certificates (depending on application).
- Where instructed, you must read the User Guides and Datasheets referenced within this manual. There, you can find detailed information on the equipment.
- The operator may only perform modifications and repairs to the equipment/system with written approval of the manufacturer.
- Do NOT operate damaged equipment.
- If faults cannot be rectified, the equipment must be taken out of service and secured against unintentional commissioning.

## 3 TECHNICAL SPECIFICATIONS

### Electrical Specifications

- Supply voltage;  $24V_{DC} \pm 10\%$
- Current consumption; 500mA maximum at  $24V_{DC}$

### Output

- Digital output; RS232  
or
- Analogue output;
  - 0 – 10  $V_{DC}$ ; load 10k $\Omega$  minimum  
and
  - 4 – 20mA; load 600 $\Omega$  maximum

### Performance Specifications

- Measurement range;
  - RS232 output; 0.1 and 100%  $O_2$
  - Analogue output<sup>a</sup>;
    - 0.1 – 25%  $O_2$
    - 0.1 – 100%  $O_2$
- Accuracy after factory calibration; 1% vol.  $O_2$ <sup>b</sup>
- Repeatability after calibration; 0.5% vol.  $O_2$
- Resolution;
  - RS232 output; 0.01% vol.  $O_2$
  - Analogue output;
    - 0 – 10 $V_{DC}$ ; 0.01V
    - 4 – 20mA; 0.01mA
- Response time (10—90% step); < 15s
- Warmup time (prior to sensor operation); 60s
- Output stabilisation time; 5 – 10mins

### Environmental Specifications

- Temperature limits (housing);
  - Storage; -10 to +85°C
  - Operating; -10 to +85°C
- Temperature limits (permissible gas temperature at probe tip);
  - Standard temperature; -100 to +250°C
  - High temperature; -100 to +400°C
- Gas flow rate; 0 to 10m/s

### Mechanical Specifications

- Dimensions; refer to [4.2 External Dimensions](#) on [page 4-1](#).
- Weight; <450g

---

<sup>a</sup> Standard ranges shown, however analogue output measurement range is user selectable also.

<sup>b</sup> Accuracy valid for measurements at Standard Barometric Pressure (SBP) in ambient gas temperatures of -30°C to +60°C.

## 4 PRODUCT OVERVIEW

The OXY-Flex analyser is housed in a sealed, die-cast aluminium enclosure with attached oxygen sensor probe and amphenol ecomate connector.

### 4.1 Main Components

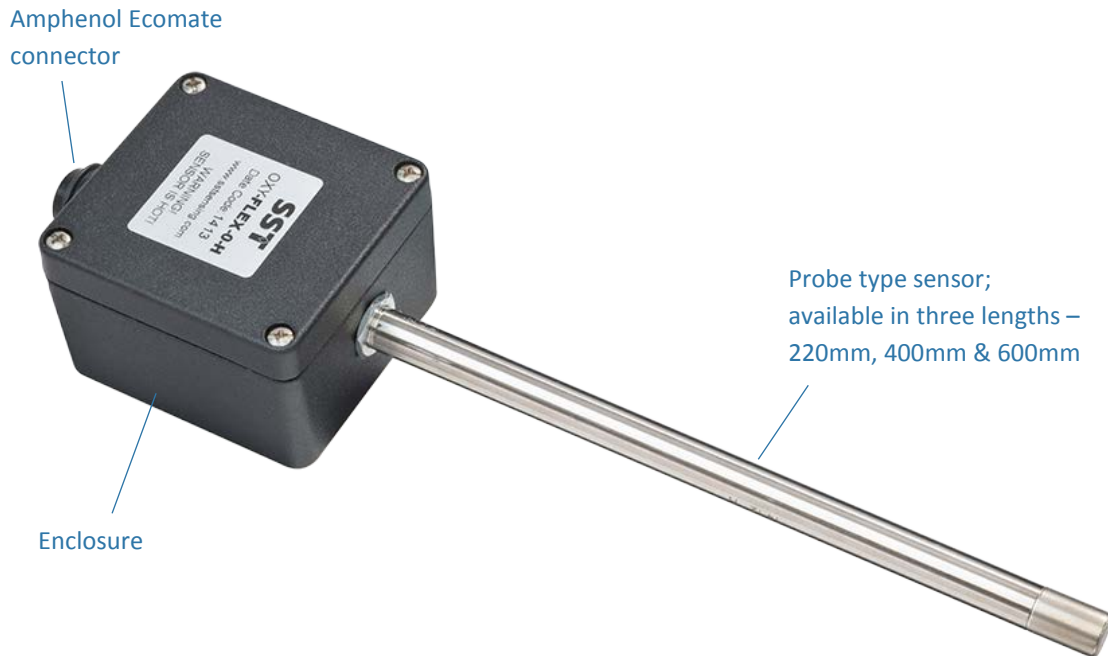

Figure 4-1 - Main Components

### 4.2 External Dimensions

Dimensions in mm unless otherwise stated; tolerance  $\pm 0.5\text{mm}$ .

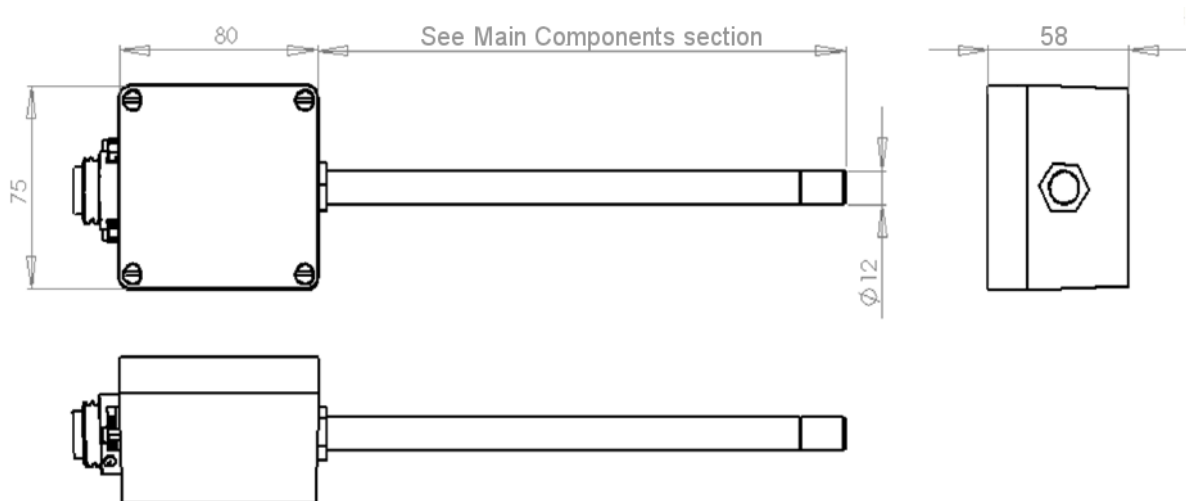

Figure 4-2 - External Dimensions

## 5 INSTALLATION

To ensure the best performance from your equipment, it must be installed correctly.

**CAUTION:** Protect the device from accidental shocks or vibrations as this may damage the board.

### 5.1 Mounting Instructions

Dimensions in mm unless otherwise stated; tolerance  $\pm 0.5\text{mm}$ .

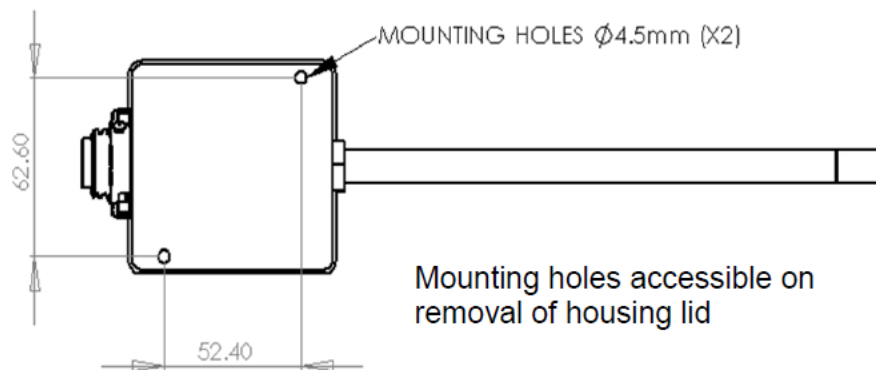

Figure 5-1 – Mounting Hole Positions

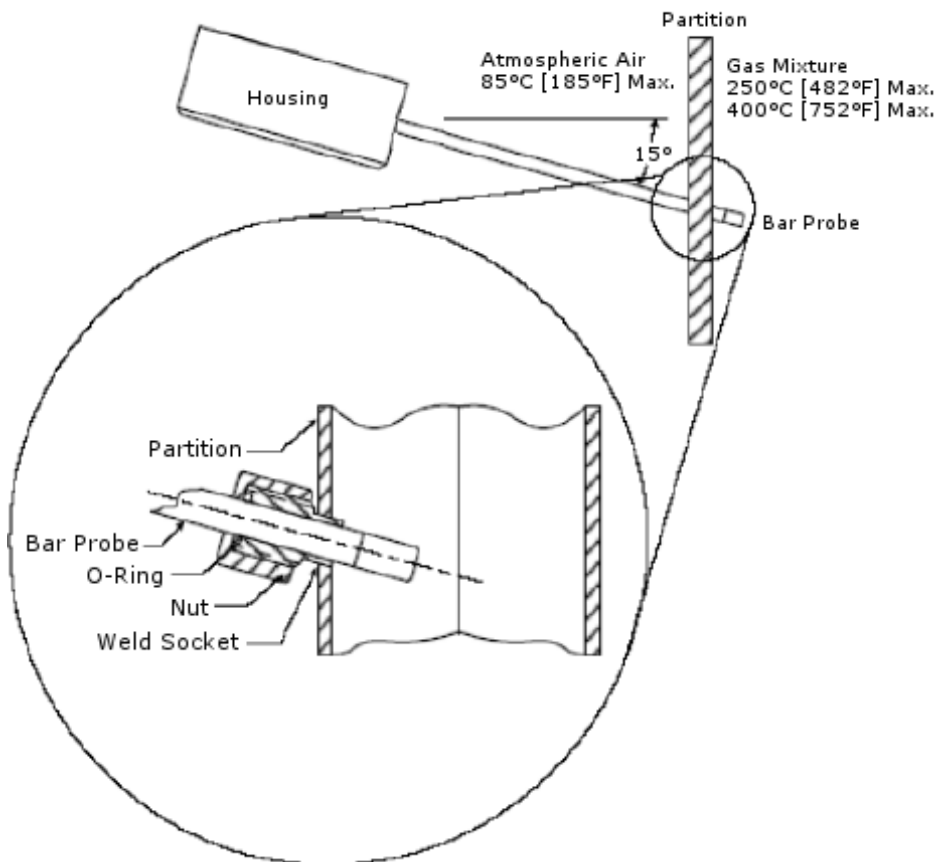

Figure 5-2 – Probe Mounting Details

## 5.2 Electrical Connections



### WARNINGS:

All wiring **MUST** be in accordance with the National Electrical Code and any local codes, ordinances, and regulations.

Disconnect and lock out power before connecting the equipment to the power supply.

The device wiring should be in a separate conduit. Do **NOT** install wiring in any conduit or junction boxes with high voltage wiring.



### CAUTION:

- Do **NOT** install the device suspended from the cable.
- Avoid exerting excessive tensile force on the cable (e.g. tugging).

**NOTE:** Electrical connections shown in [Figure 5-3](#).

Housing: Amphenol Ecomate C016 30C006 100 12

Mating Connector: Binder 99-4218-00-07

**NOTE:** Mating connector also supplied.

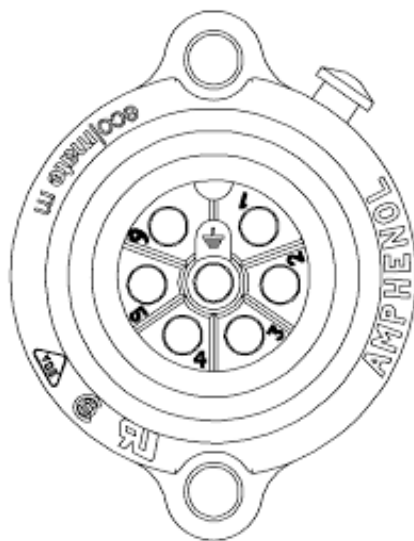

### PINOUT:

Pin 1:  $24V_{DC} \pm 10\%$

Pin 2:  $0V_{DC}$

Pin 3: Calibrate

Pin 4: Cycle

Pin 5:  $4 - 20mA$  / RS232 Tx

Pin 6:  $0 - 10V_{DC}$  / RS232 Rx

Centre: Housing / Probe Earth

Figure 5-3 - Electrical Connections

### NOTES:

- Output pins 5 and 6 are both referenced to the power supply  $0V_{DC}$  (pin 2). Due to high current flow in the supply GND, when monitoring the  $0 - 10V_{DC}$  output (pin 6) it is recommended that a separate GND wire for the measurement system is taken from pin 2. This removes errors due to voltage drops in the power supply connections.
- Assignment of output pins 5 and 6 selectable by altering the position of the jumper links on the PCB; refer to [5.4 PCB Layout](#) on [page 5-3](#) for details.



### 5.3 System Block Diagram

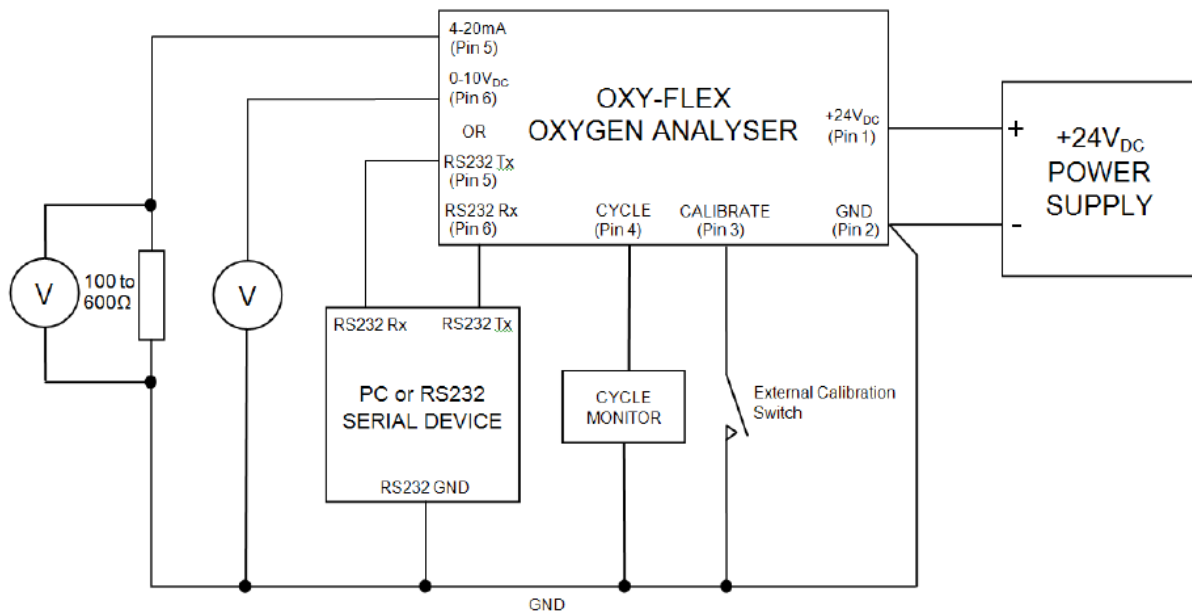

Figure 5-4 - Block Diagram

### 5.4 PCB Layout

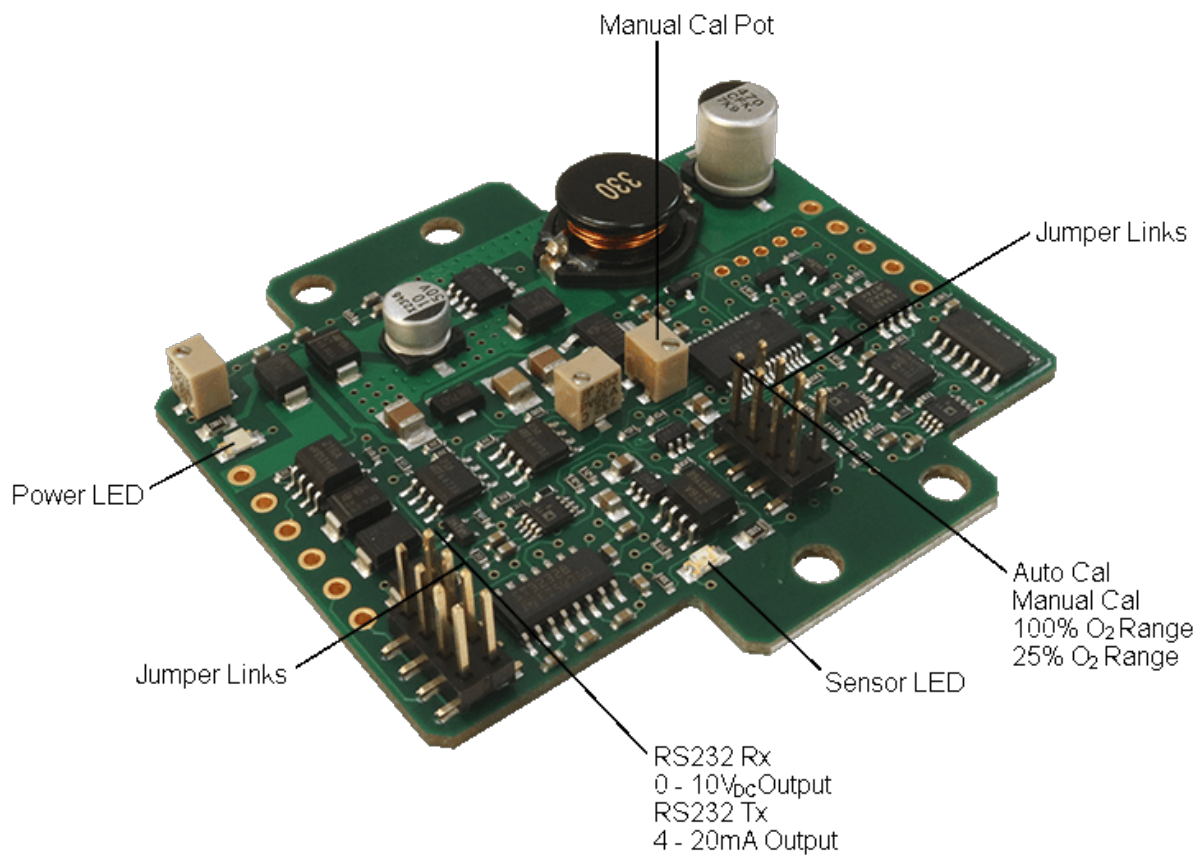

Figure 5-5 - PCB Layout

## 6 INITIAL STARTUP

### 6.1 Commissioning Checks

Before commissioning the equipment read [2 SAFETY INSTRUCTIONS](#) on [page 2-1](#) of this document.

Complete the following essential tasks BEFORE switching the system ON for the first time:

- Ensure compliance with permissible installation position.
- Verify the device is mounted securely correctly.
- Verify the device and wiring are all undamaged.
- Ensure the cables are strain-free.
- Ensure the device is connected properly, with all its inputs and outputs complete. All screw terminals are properly tightened. All connectors seated correctly.



**CAUTION:** Test the power supply to ensure it is “ $24V_{DC} \pm 10\%$ ” before wiring to the board.

**CAUTION:** Failure to test the suitability of the power supply BEFORE first power on could result in irreversible product damage that is NOT covered by warranty.

### 6.2 Switching ON

When the device is initially powered ON, the:



Red LED illuminates solid to indicate power is being supplied to the interface.

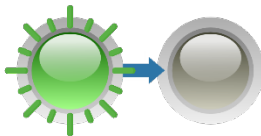

Green LED blinks rapidly then goes OFF to indicate that the microprocessor is operational.

**NOTE:** LEDs are only visible when the lid is removed from the analyser housing.

**NOTE:** If a fault is detected, an error is displayed (RS232 variant), or the analogue output will remain at 4mA or 0V. Refer to [9.3 Error Conditions](#) on [page 9-3](#).

If the error condition persists, switch the device OFF and contact [technical@sstsensing.com](mailto:technical@sstsensing.com).

### 6.3 First-time Calibration

Calibration, or re-referencing, is required when the product is powered ON in the process application for the first time. Refer to [9.2 Calibrating](#) starting on [page 9-1](#).

## 7 SYSTEM CONFIGURATION

The OXY-Flex can be configured to output measuring ranges of 0 – 25% O<sub>2</sub> and 0 – 100% O<sub>2</sub>; the entire measurement range is linear in both cases.

**NOTE:** Factory default is 0 – 25% O<sub>2</sub> with linear 4-20mA and 0-10V<sub>DC</sub> outputs.

When configured for 0 – 100% O<sub>2</sub>, the analogue output ranges can be customised to suit the application. Refer to [7.2 Setting the Calibration Type and Measurement Range](#) on [page 7-2](#).

The outputs can be configured to either 4 – 20mA and 0 – 10V<sub>DC</sub> or RS232. Refer to [7.1 Setting the Output Type](#).

**NOTE:** All outputs are referenced to the system GND.

A digital 3.3V<sub>DC</sub> logic output cycles at the same frequency as the electrochemical pumping action of the oxygen sensing cell during normal operation, thus providing a real-time sensor health check. If the output ceases to cycle, the sensor has entered a start-up or error state. This provides fault proof operation.

**NOTE:** The digital output is also used during the calibration process to indicate the interface status. A green on-board LED mirrors the CYCLE output and can be used to visually determine the sensor status or during the calibration process. A red LED indicates the unit has power applied.

### 7.1 Setting the Output Type

The interface board is fitted with two jumper links which set the calibration type (Manual or Automatic) and oxygen measurement range (100% or 25%). These settings may be configured at any time by adjusting the position of the header pin jumper links on the board.



**WARNING:** The equipment **MUST** be powered OFF.

The jumper links **MUST** also be repositioned correctly and in the correct orientation.

1. Using a Philips screwdriver, remove the four screws and lid from the analyser housing.
2. Using thin-nosed pliers, remove and replace the jumper links to the desired positions:
  - **RS232;** RS232 Rx and RS232 Tx
  - **Analogue output;** 0 – 25% O<sub>2</sub> or 0 – 100% O<sub>2</sub>

**NOTE:** When selecting the output, you must choose either 4-20mA and 0-10V<sub>DC</sub> or RS232 Tx and Rx.

**NOTE:** Ensure jumper links are correctly seated and in the correct orientation as shown in [Figure 7-1](#).

3. When configuration is complete, replace the four screws and lid; secure to the analyser housing using a Philips screwdriver.

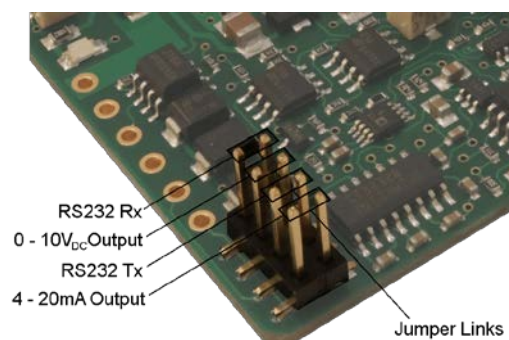

**Figure 7-1 – Output Jumper Link Configuration**

## 7.2 Setting the Calibration Type and Measurement Range

The interface board is fitted with two jumper links which set the calibration type (Manual or Automatic) and oxygen measurement range (100% or 25%). These settings may be configured at any time by adjusting the position of the header pin jumper links on the board.



**WARNING:** The equipment **MUST** be powered OFF.

The jumper links **MUST** also be repositioned correctly and in the correct orientation.

1. Using a Philips screwdriver, remove the four screws and lid from the analyser housing.
2. Using thin-nosed pliers, remove and replace the jumper links to the desired positions:
  - **Calibration type;** Manual (MANUAL CAL) or Automatic (AUTO CAL)
  - **Measuring range;** 0 – 25% O<sub>2</sub> or 0 – 100% O<sub>2</sub>

**NOTE:** Ensure jumper links are correctly seated and in the correct orientation as shown in [Figure 7-2](#).

3. When configuration is complete, replace the four screws and lid; secure to the analyser housing using a Philips screwdriver.

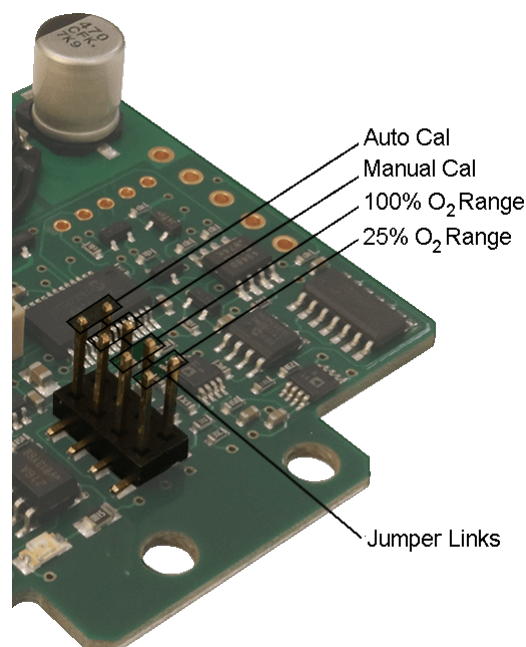

Figure 7-2 - Jumper Link Configuration

### 7.3 Digital Variant – RS232 Output

**NOTE:** When connecting the OXY-Flex using the RS232 connections ensure *Tx* goes to *Rx* of the PC and *Rx* goes to *Tx* of the PC.

The OXY-Flex communicates via standard COM port settings that are default on most PCs and many other RS232 compatible devices. If, however communication problems are occurring use the settings below to configure the PC or device COM Port:

- **Baudrate:** 9600
- **Data bits:** 8
- **Parity:** None
- **Stop bits:** 1
- **Flow control:** None

With the OXY-Flex RS232 outputs connected to a PC (or other RS232 compatible device), you can access two modes of operation; continuous data streaming and the menu screens. Menu structure has been created using VT100 terminal codes; refer to [APPENDIX A – MENU STRUCTURE](#) starting on [page A-1](#) for full menu structure and example screens.

Recommended programs for communicating via PC serial RS232 are Tera Term, HyperTerminal (Windows default), or PuTTY. The following sub-sections are based on Tera Term usage, instructions may vary if using another program.

When the OXY-Flex receives an <ENTER> keystroke from the connected PC or device, it automatically displays the `Menu Password` screen and stops streaming O<sub>2</sub> % and *Td* values. Once the correct password is entered followed by the <ENTER> keystroke, the menu screens are accessed. The menu screens are primarily for diagnostics and information although there are user configurable options that may be changed. These are the automatic O<sub>2</sub> calibration %, the amount of output filtering (averaging) and the analogue output ranges. The menu security password may also be changed if required.

#### 7.3.1 Menu Security Password

The password is factory set to “default”. This however may be changed to a user specific password.

1. Connect the OXY-Flex via the RS232 interface to the PC.
2. Press <ENTER>; the `Menu Password` screen displays.
3. Input your current security password.
4. Press <ENTER> to access the `Menu` screens.
5. Type “2” to access the `Configuration` menu.
6. Type “3” to access the `Password Menu` screen.
7. Input your new security password.

**NOTE:** Password is case sensitive and a maximum 15 characters.

8. Press <ENTER> to save.

**NOTE:** The new password is now stored in memory and is retained on power loss.

**NOTE:** Pressing <ESC> returns the screen to the previous menu.

### 7.3.2 Automatic Calibration Value

The system is factory set to automatically calibrate to 20.7% O<sub>2</sub> to allow simple calibration in fresh air. The auto calibration value is factory set to 20.7% to take into account average humidity in the atmosphere. If a calibration with a gas of a different known O<sub>2</sub> concentration is required, the factory set value may be changed via the RS232 interface.

1. Connect the OXY-Flex via the RS232 interface to the PC.
2. Press <ENTER>; the Menu Password screen displays.
3. Input your security password.
4. Press <ENTER> to access the Menu screens.
5. Type "2" to access the Configuration menu.
6. Type "1" to access the Enter Auto Calib screen.
7. Input the oxygen concentration (%) of the calibration gas as a number to 2 decimal places.
8. Press <ENTER> to save.

**NOTE:** The new automatic calibration value is now stored in memory and is retained on power loss.

**NOTE:** If calibration is required with a different gas of known O<sub>2</sub> concentration and access to the RS232 menus via a PC is not available, a manual calibration must be performed. Refer to [9.2.2 Manual Calibration](#) on page 9-2.

### 7.3.3 Variable Output Filtering (T<sub>d</sub> Averaging)

The OXY-Flex is factory default to use adaptive output filtering to give an optimum balance between output stability and response to oxygen changes. This balance may be altered to suit the needs of your application.

1. Connect the OXY-Flex via the RS232 interface to the PC.
2. Press <ENTER>; the Menu Password screen displays.
3. Input your security password.
4. Press <ENTER> to access the Menu screens.
5. Type "2" to access the Configuration menu.
6. Type "2" to access the Enter T<sub>d</sub> Averaging screen.
7. Input the required number, between 0 and 200; 0 for adaptive filtering (recommended), 1 for very fast and dynamic output response but relatively unstable to 200 for an extremely stable output but very slow response to oxygen changes.
8. Press <ENTER> to save.

**NOTE:** The new averaging value is now stored in memory and is retained on power loss.

### 7.3.4 Analogue Output Minimum and Maximum Ranges

The OXY-Flex is factory default to output a range of 0 – 25% O<sub>2</sub> via its two analogue outputs. This range can be expanded to 0 – 100% O<sub>2</sub> by repositioning the jumper link as described on [page 7-1](#). When the unit is reconfigured to output 0 – 100% O<sub>2</sub> the user also has the option to fully customise the output ranges via RS232. This is extremely useful in applications where the O<sub>2</sub> variation is within a narrow band as it allows the analogue outputs to be tailored to this limited range.

**NOTE:** The minimum and maximum range adjustment does NOT apply to the RS232 output and is overruled if the unit is reconfigured for 0 – 25% O<sub>2</sub> operation.

1. Ensure the OXY-Flex is configured for 0 – 100% O<sub>2</sub> operation, see [page 7-1](#).
2. Connect the OXY-Flex via the RS232 interface to the PC.
3. Press <ENTER>; the Menu Password screen displays.
4. Input your security password.
5. Press <ENTER> to access the Menu screen.
6. Type “2” to access the Configuration menu.
7. Type “3” to access the Enter O<sub>2</sub> Max Range screen.
8. Input the required number, between 1.00 and 100.00 to represent the maximum output range.

**NOTE:** The number must also be greater than the saved minimum range.

9. Press <ENTER> to save.
10. Press <ESC> to return to the Configuration menu.
11. Type “4” to access the Enter O<sub>2</sub> Min Range screen.
12. Input the required number, between 0.00 and 99.00 to represent the minimum output range.

**NOTE:** The number must also be less than the saved maximum range.

13. Press <ENTER> to save.

**NOTE:** The new ranges are now stored in memory and are retained on power loss.

An example of changing the minimum and maximum output ranges would be in a fresh air atmosphere where the O<sub>2</sub> range is between 20-21%. The user could set the minimum output range to 19% and the maximum output range to 22% and the outputs would vary linearly between. The minimum and maximum ranges lock out the outputs at the set limits so 19% O<sub>2</sub> or lower would set the analogue outputs to 0V<sub>DC</sub>/4mA and 22% O<sub>2</sub> or higher would set the analogue outputs to 10V<sub>DC</sub>/20mA.

## 7.4 Analogue Variants – 0-10V<sub>DC</sub> and 4-20mA Output Values

Table 7-1 Analogue Output Values

O <sub>2</sub> %	Output Values			
	0 – 10V <sub>DC</sub> output		4 – 20mA output	
	0.1 – 25% O <sub>2</sub>	0.1 – 100% O <sub>2</sub>	0.1 – 25% O <sub>2</sub>	0.1 – 100% O <sub>2</sub>
<b>20.7%</b>	8.28V <sub>DC</sub>	2.07V <sub>DC</sub>	17.25mA	7.34mA
<b>100%</b>	-	10V <sub>DC</sub>	-	20mA
<b>90%</b>	-	9.0V <sub>DC</sub>	-	18.4mA
<b>25%</b>	10V <sub>DC</sub>	2.5V <sub>DC</sub>	20mA	8mA
<b>5%</b>	2.0V <sub>DC</sub>	0.5V <sub>DC</sub>	7.2mA	4.8mA
<b>0.01% (see Note)</b>	0.04V <sub>DC</sub>	0.01V <sub>DC</sub>	4.06mA	4.02mA

**NOTE:** The analogue output ranges actually represent 0 to 25% or 0 to 100% O<sub>2</sub> however as SST's oxygen sensors cannot measure below 0.1% O<sub>2</sub> this value is displayed as the range minimum.



## 8 OPERATION

### 8.1 Operating Tips

To ensure the best performance from your equipment it is important that the attached oxygen sensor is installed and maintained correctly. Refer to *AN-0050, O<sub>2</sub> Sensors – Zirconia Dioxide Sensor Operation and Compatibility Guide* for some useful sensor operating tips and a list of gases and materials that must be avoided to ensure a long sensor life.

### 8.2 RS232 Operation

With the OXY-Flex RS232 outputs connected to a PC (or any other RS232 compatible device), you can access two modes of operation; continuous data streaming and the menu screens. Refer to [7.3 Digital Variant – RS232 Output](#) on [page 7-3](#). Refer also to [APPENDIX A – MENU STRUCTURE](#) starting on [page A-1](#).

#### 8.2.1 Continuous Data Streaming

On power up, after the initial 60s heater delay, the OXY-Flex will automatically begin outputting the measured O<sub>2</sub> concentration and sensor  $t_d$  as both an averaged and raw value.

The averaged values give a stable output with the amount of averaging user variable whilst the raw un-averaged values allow the user to detect sudden oxygen changes.

The averaged value is the measurement output on both the 4 – 20mA and 0 – 10V<sub>DC</sub> outputs. The sensor  $t_d$  value is the measure of the partial pressure of oxygen in the measurement gas. The O<sub>2</sub> concentration (%) is the  $t_d$  value scaled by the stored calibration value.

To stop or restart the data streaming:

1. Connect the OXY-Flex via the RS232 interface to the PC.
2. Type "S" (not case sensitive).  
**NOTE:** Data streaming automatically ceases during calibration.

#### 8.2.2 Menu Screens

The menu screens are primarily for diagnostics and information although there are user configurable options that may be changed. Refer to [7.3 Digital Variant – RS232 Output](#) on [page 7-3](#).

To access the menu structure:

1. Connect the OXY-Flex via the RS232 interface to the PC.
2. Press <ENTER>; the Menu Password screen displays.  
**NOTE:** The OXY-Flex stops outputting O<sub>2</sub>% and  $t_d$  values.
3. Input your security password.
4. Press <ENTER> to access the Menu screens.

## 9 MAINTENANCE



**WARNING:** BEFORE performing any type of maintenance on the equipment read [2 SAFETY INSTRUCTIONS](#) on [page 2-1](#) of this document.

**WARNING:** The attached oxygen sensor is heated to over 700°C (1300°F) and is a source of ignition. Ensure the sensor is cool before attempting to touch or service the equipment.

### 9.1 Cleaning

Clean the outer surfaces of the housing regularly with non-abrasive materials to prevent a buildup of contaminants. Isopropyl alcohol (IPA) and a lint-free cloth is recommended.



**CAUTION:** Never use any of the following for cleaning purposes:

- Chemical cleaning agents
- High-pressure water or steam

### 9.2 Calibrating

SST Sensing's range of zirconium oxygen sensors do not directly measure the oxygen concentration but instead measure the partial pressure of oxygen within the measurement gas. In order to output an oxygen concentration (%) the sensor must be calibrated, or more specifically, re-referenced in a known gas concentration, typically fresh air.

Regular calibration removes the effects of application and atmospheric pressure changes and also eliminates any sensor drift that may occur during the first few hundred hours of operation.

Calibration, or re-referencing, is achieved by connecting the calibration input to GND and monitoring the status of the digital cycle output or by visually monitoring the on-board green LED. During the calibration process the output will either automatically calibrate to a fixed reference or can be manually calibrated to any output by way of a PCB mounted potentiometer.

**NOTE:** The fixed reference is factory set to 20.7% O<sub>2</sub> for calibration in fresh air, however this value may be altered for calibration with a reference gas of any known oxygen concentration. Any new calibration value will be stored on power loss.

The auto or manual calibrate function is user configurable; refer to [7.1 Setting the Calibration Type and Measurement Range](#) on [page 7-1](#).

Output Variant	Recommended Calibration Points / Recommended Calibration Gas
0.1 - 25% O <sub>2</sub>	20.7% O <sub>2</sub> / Fresh air
0.1 - 100% O <sub>2</sub>	100% O <sub>2</sub> / Pure oxygen

### 9.2.1 Automatic Calibration

1. Ensure the OXY-Flex is configured for automatic calibration. Refer to [7.1 Setting the Calibration Type and Measurement Range on page 7-1](#).
2. Place the sensor probe in the calibration gas, typically fresh air.
3. Allow the output to stabilise for at least 5 minutes (10 minutes if powering from cold).
4. Referring to [Figure 5-3 on page 5-2](#); Apply GND to the CALIBRATE input (pin 3) for a minimum 12s. During the 12s the CYCLE output (pin 4) and the green LED will go high/on, blink rapidly, go high/on, go low/off then return to cycling normally to indicate normal operation has resumed. At this point remove GND from pin 3.

**NOTE:** The output will now track to the correct value for the calibration gas<sup>c</sup>.

5. Calibration is complete.

**NOTE:** New calibration values are stored in memory and retained on power loss.

### 9.2.2 Manual Calibration

1. Ensure the OXY-Flex is configured for manual calibration. Refer to [7.1 Setting the Calibration Type and Measurement Range on page 7-1](#).
2. Place the sensor probe in the calibration gas, typically fresh air.
3. Allow the output to stabilise for at least 5 minutes (10 minutes if powering from cold).
4. Referring to [Figure 5-3 on page 5-2](#); Apply GND to the CALIBRATE input (pin 3) for a minimum 5s or until the CYCLE output and green LED blink at a steady 1Hz. Remove GND from pin 3. Manual Calibration is now initialised.
5. Referring to [Figure 4-1 on page 4-1](#); Adjust the MANUAL CAL POT until the output equals the correct value of the calibration gas concentration (see [Table 7-1 on page 7-6](#)).
6. Re-apply GND to pin 3 for a minimum 5s. During the 5s the CYCLE output/LED will blink rapidly, go high/on, go low/off then return to cycling normally to indicate normal operation has resumed. At this point remove GND from pin 3.

**NOTE:** The output will now track to the correct value for the calibration gas<sup>c</sup>.

7. Calibration is complete.

**NOTE:** New calibration values are stored in memory and retained on power loss.

---

<sup>c</sup> If calibrating in fresh air, the output value (RS232/Voltage/Current) given equates to 20.7% oxygen with an error of  $\pm 0.2\%$ . After calibration in fresh air the voltage output should read 8.28V. The current output should read 17.25mA, and the RS232 will stream a five character ASCII code representing the O<sub>2</sub>%.

### 9.3 Error Conditions

If the oxygen sensor is incorrectly connected or is damaged, the OXY-Flex will highlight this by blinking the CYCLE output (pin 4) and green LED in a *3 short blinks – 1 long blink* pattern or continuously OFF. In addition, an error code displays on the RS232 output and the analogue outputs will default to 4mA and 0V.

If an error condition occurs, the equipment should be powered down and all wiring checked before reapplying the power. If the error condition remains, contact [technical@sstsensing.com](mailto:technical@sstsensing.com) for guidance.

### 9.4 Disposal

The OXY-Flex should be disposed of as electrical waste. Please observe your local regulations.

## APPENDIX A – MENU STRUCTURE

### Password Screen

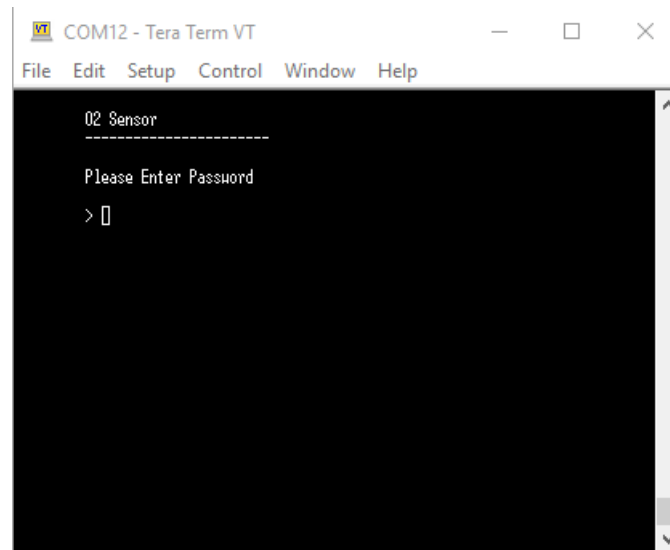

### Main Menu

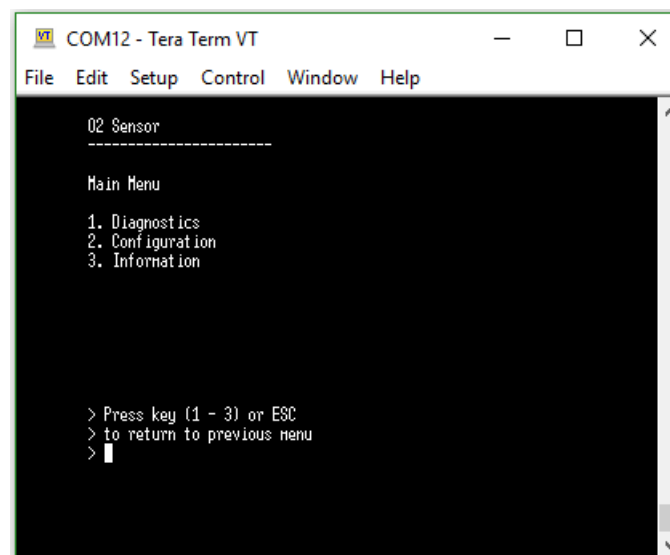

## Diagnostics Screens

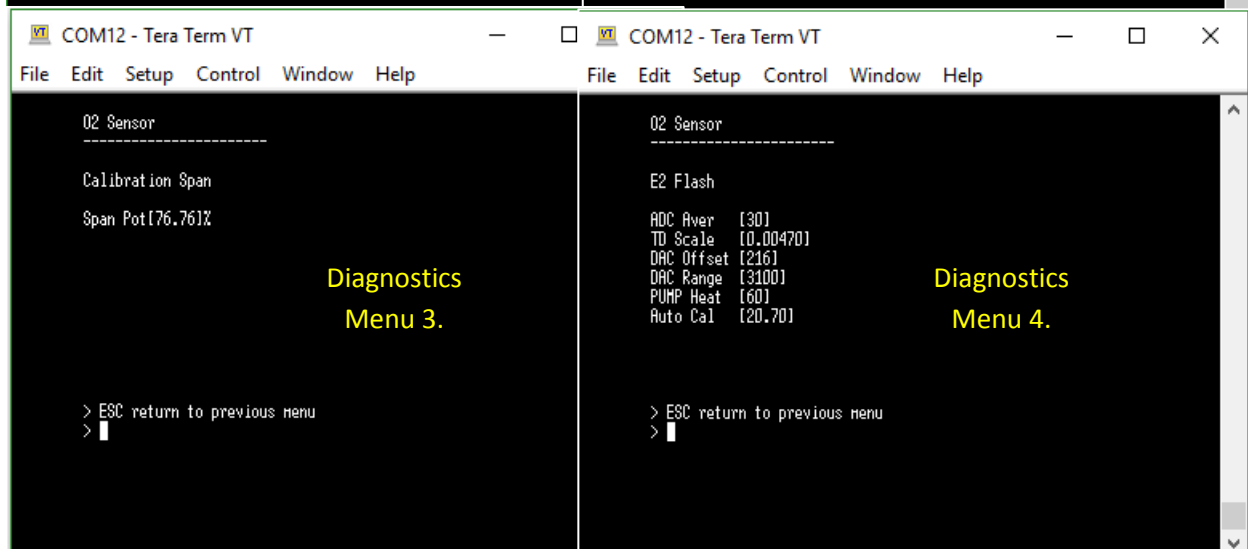
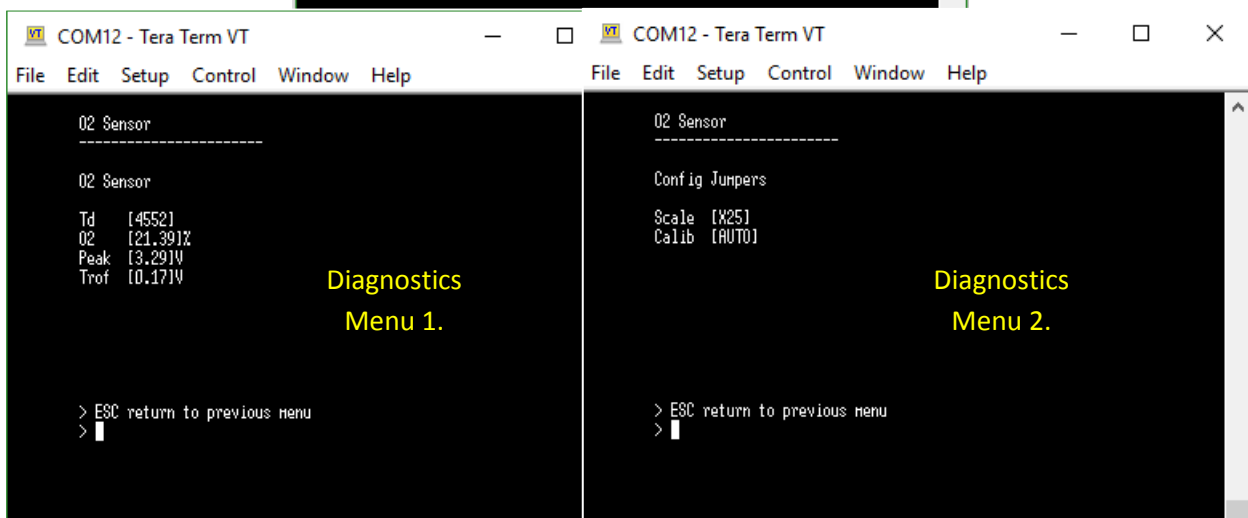
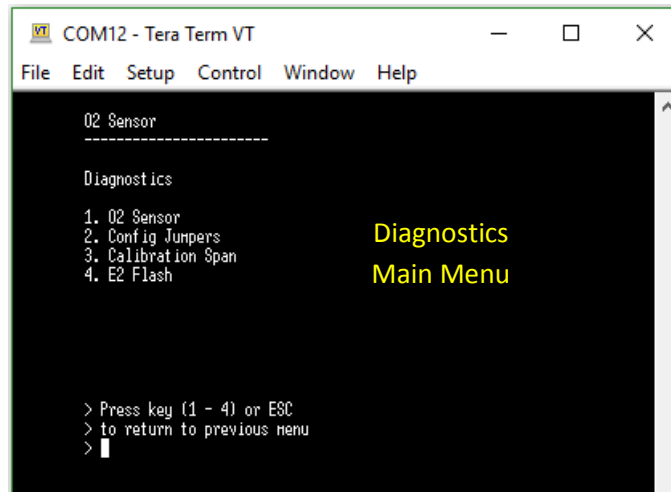

## Configuration Screens

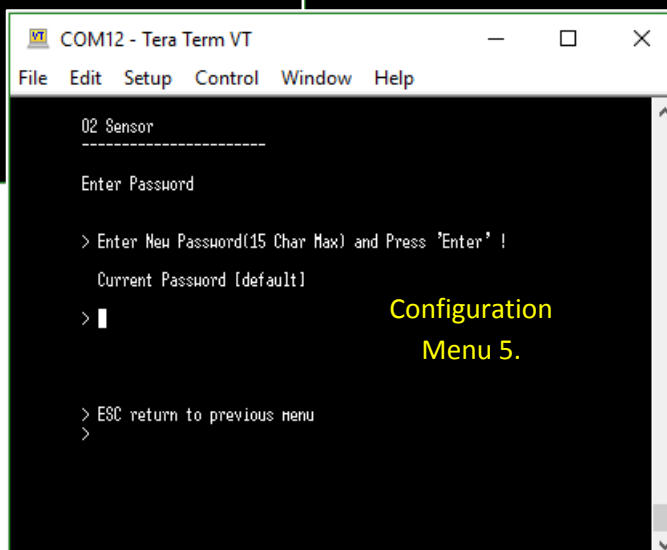
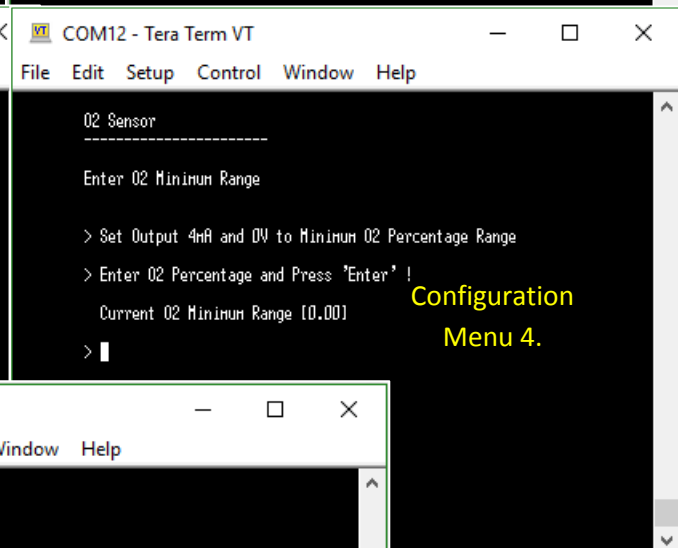
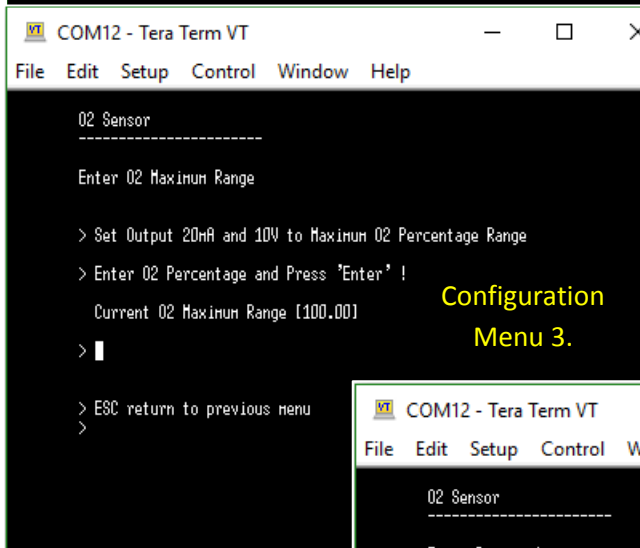
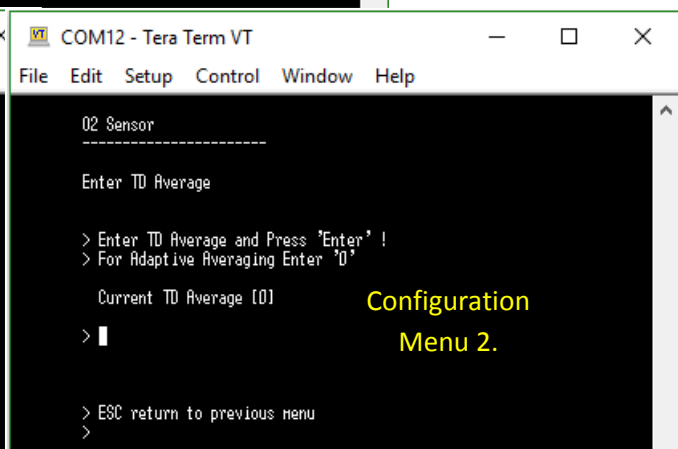
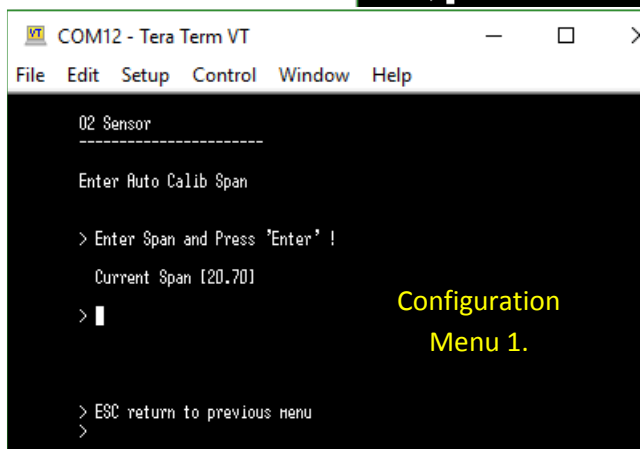
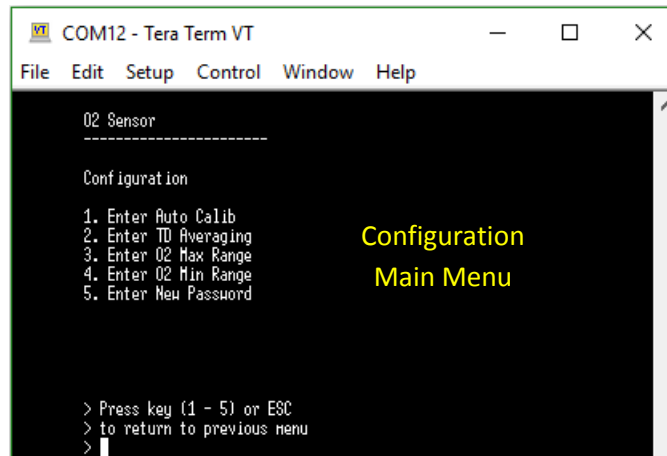

## Information Screens





## REFERENCE DOCUMENTS

Other documents in the Zirconium Dioxide product range are listed below; this list is not exhaustive, always refer to the [SST website](#) for the latest information.

Part Number	Title
AN-0043	Zirconia O <sub>2</sub> Sensor Operating Principle and Construction Guide
AN-0050	Zirconia O <sub>2</sub> Sensor Operation and Compatibility Guide
AN-0076	Zirconia O <sub>2</sub> Sensor Selection Guide
DS-0074	O2I-Flex Oxygen Sensor Interface Board Datasheet
QS-002	O2I-Flex Oxygen Sensor Interface Board Quick Start Guide
DS-0044	Zirconia O <sub>2</sub> Sensors Flange Mounted Series Datasheet
DS-0051	Zirconia O <sub>2</sub> Sensors Miniature Series Datasheet
DS-0052	Zirconia O <sub>2</sub> Sensors Probe Series - Short Housing Datasheet
DS-0053	Zirconia O <sub>2</sub> Sensors Probe Series - Screw Fit Housing Datasheet
DS-0055	Zirconia O <sub>2</sub> Sensors Oxygen Measurement System Datasheet
DS-0058	OXY-LC Oxygen Sensor Interface Board Datasheet
DS-0072	OXY-COMM Oxygen Sensor Datasheet
DS-0073	OXY-Flex Oxygen Analyser Datasheet
DS-0122	Zirconia O <sub>2</sub> Sensors Probe Series - OEM Screw Fit Housing Datasheet
DS-0131	Zirconia O <sub>2</sub> Sensors Probe Series - Long Housing Datasheet

### CAUTION

Do not exceed maximum ratings and ensure sensor(s) are operated in accordance with their requirements.  
Carefully follow all wiring instructions. Incorrect wiring can cause permanent damage to the device. Zirconium dioxide sensors are damaged by the presence of silicone. Vapours (organic silicone compounds) from RTV rubbers and sealants are known to poison oxygen sensors and MUST be avoided. Do NOT use chemical cleaning agents.

**Failure to comply with these instructions may result in product damage.**

### INFORMATION

As customer applications are outside of SST Sensing Ltd.'s control, the information provided is given without legal responsibility. Customers should test under their own conditions to ensure that the equipment is suitable for their intended application.

For technical assistance or advice, please email: [technical@sstsensing.com](mailto:technical@sstsensing.com)

**General Note:** SST Sensing Ltd. reserves the right to make changes to product specifications without notice or liability. All information is subject to SST Sensing Ltd.'s own data and considered accurate at time of going to print.

SST SENSING LIMITED, 5 HAGMILL CRESCENT, SHAWHEAD INDUSTRIAL ESTATE, COATBRIDGE, UK, ML5 4NS  
[www.sstsensing.com](http://www.sstsensing.com) | e: [sales@sstsensing.com](mailto:sales@sstsensing.com) | t: +44 (0)1236 459 020 | f: +44 (0)1236 459 026