

Bussmann electrical full line catalog

Leadership in Circuit Protection



Introducing Bussmann by Eaton

The protection you rely on. For more, visit Bussmann.com



Bussmann
by **EATON**



Leadership in Circuit Protection.

The only company that can provide a complete circuit protection solution for all applications.

Only Eaton can deliver...

- The most diverse solutions to mitigate arc flash energy to keep people and equipment safe
- The smallest and most cost effective way to meet selective coordination requirements
- The most experienced, time-tested solutions to meet national & local code requirements
- The easiest specifications with the most tested fuse/circuit breaker and circuit breaker/circuit breaker series rated combinations
- The only one-stop shop to solve your design challenges using our expertise and an unmatched portfolio

The Eaton advantage.

Powering business worldwide

As a global diversified power management company, we help customers worldwide manage the power needed for buildings, aircraft, trucks, cars, machinery and businesses.

Eaton's innovative technologies help customers manage electrical, hydraulic and mechanical power more reliably, efficiently, safely and sustainably.

We provide integrated solutions that help make energy, in all its forms, more practical and accessible.

With 2012 sales of \$16.3 billion, Eaton has approximately 103,000 employees around the world and sells products in more than 175 countries.

Eaton.com

EATON

Powering Business Worldwide



3 TIERS OF PROTECTION

Speed up Specification and Selection

Ultimate Protection— The best worry free protection in virtually any application. A powerful combination of all performance options in one fuse.

Advanced Protection— Application specific protection for sensitive devices and critical components or motors and transformers.

Basic Protection— Basic single-element protection for service, feeder and branch circuit applications.



4 FUSE FAMILIES

Make Fuse Selection and Replacement Easy

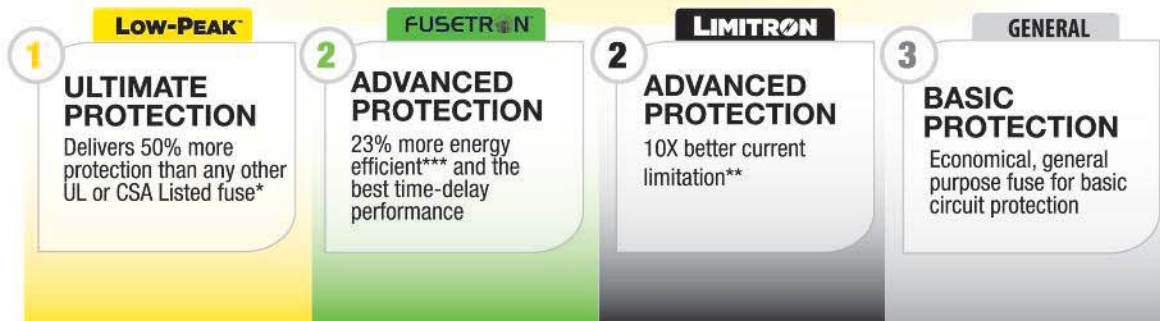

* 50% higher IR (300KA) than any other UL and CSA Listed Fuse. Includes Class J, L and R fuses.

** Does not include current limiting circuit breakers or current limiting fuses. Protection determined by comparing published values for let-through for Class CC, J, R, and T fuses versus a symmetrical RMS waveform at 250kA.

*** Test results are based on weighted sales volume of FUSETRON and Ferraz Shawmut (Mersen) fuses by selected amp and volt rating combination. Next leading brand refers to Ferraz Shawmut based on third-party fuse market share data for a twenty-seven month period (July 2008 through September 2010).



A Complete Line of **Circuit Protection Solutions** for the **Alternative Energy Markets**

56
PVM Midget
& PV Fuses



63
XL Photovoltaic
Fuses and Blocks



289
Modular
Knifeblade
Fuse Blocks



57
CUBEFuse™
PVCF & WCF



121
Square Body,
BS and UL
High Speed Fuses



325
Power
Distribution
Blocks



59
PVS-R RK5
PV Fuses



266
Quik-Spec™
Coordination
Panelboard



442
Surge Protection
Solutions
Photovoltaic and Wind



60
Ferrule
Photovoltaic
Fuses



270
Safety Switches
AC & DC



62
NH Fuses &
Fuse Blocks



274
Modular Fuse
Holders



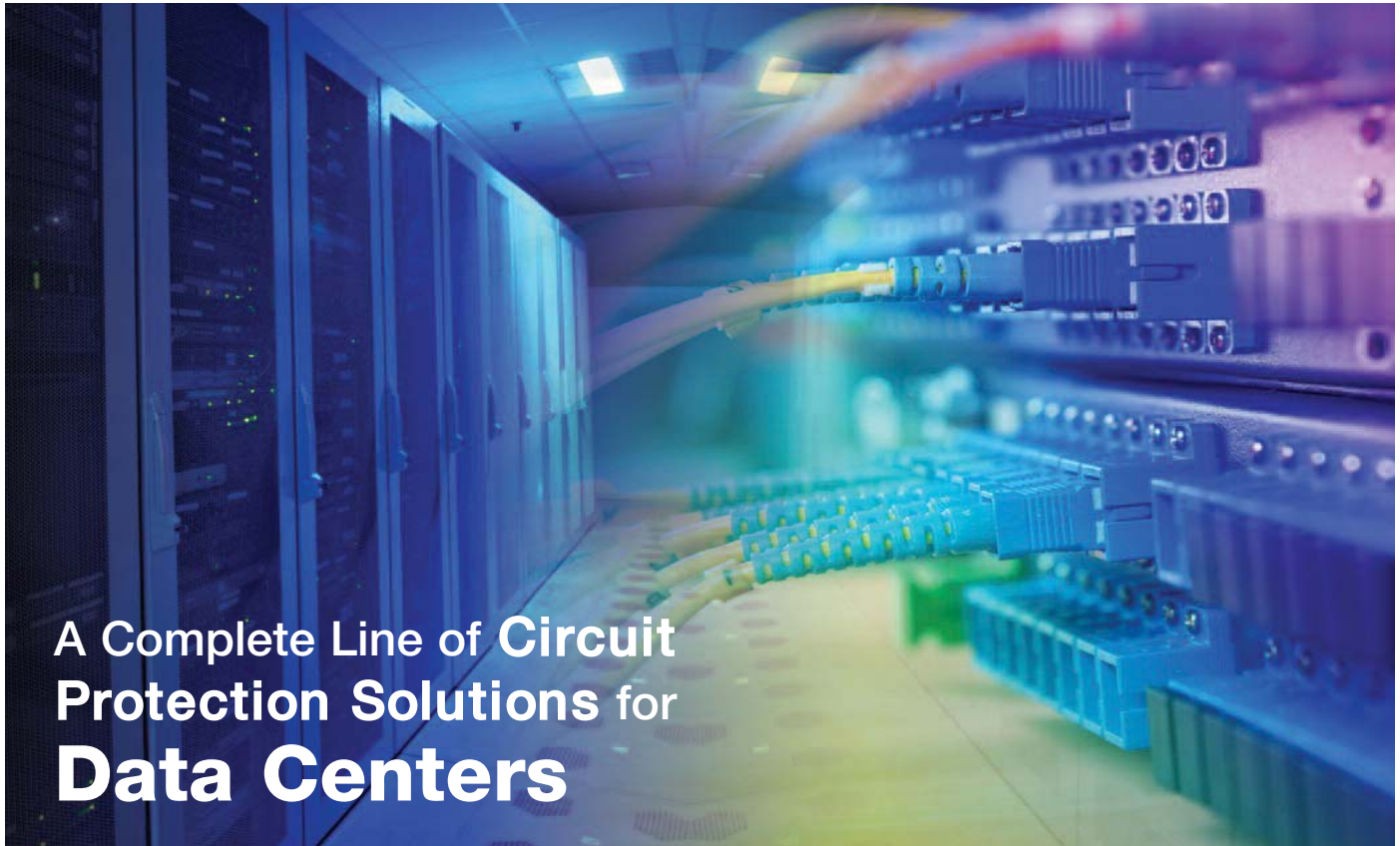

A Complete Line of Circuit Protection Solutions for Data Centers

23

Low-Peak™
CC Fuses



125

DFJ
High Speed
Fuses



333

DIN-Rail Terminal
Blocks and
Connectors



28

CUBEFuse™
TCF & FCF



266

Quik-Spec™
Coordination
Panelboard



380

Compact Circuit
Protectors



121

Square Body,
BS and UL
High Speed Fuses



325

Power
Distribution
Blocks



441

Surge Protection
Solutions
– UL, IEC and LV



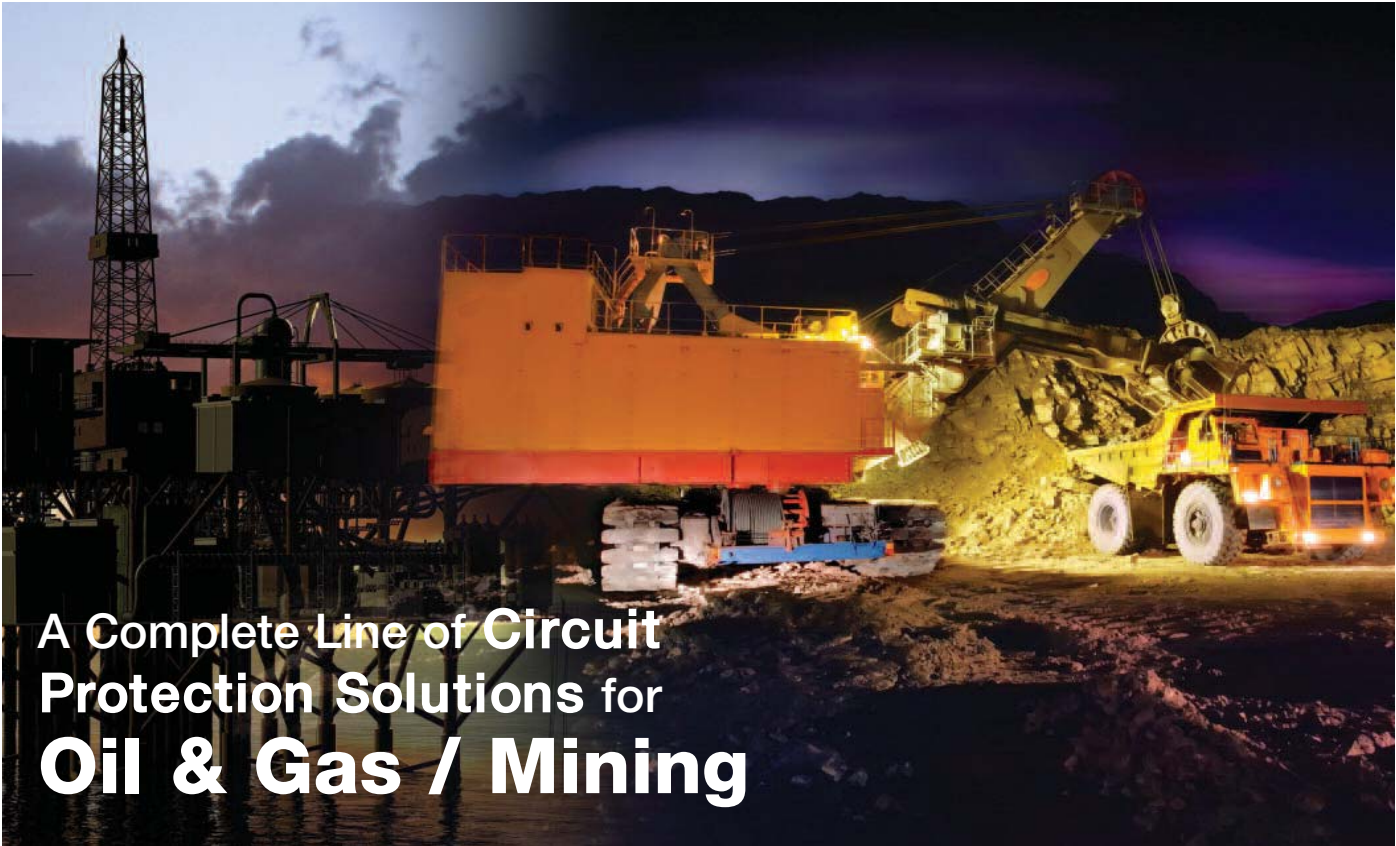

A Complete Line of Circuit Protection Solutions for Oil & Gas / Mining

23

Low-Peak™
Fuses



121

Square Body,
BS and UL
High Speed Fuses



327

Power
Distribution
Blocks



26

CUBEFuse™
TCF & FCF



125

DFJ
High Speed
Fuses



380

Compact Circuit
Protectors



46

Fusetron™ Energy
Efficient Fuses



266

Quik-Spec™
Coordination
Panelboard



441

Surge Protection
Solutions
– UL, IEC and LV



62

NH Fuses &
Fuse Blocks



274

Modular Fuse
Holders



99

Medium
Voltage Fuses



289

Modular
Knifeblade
Fuse Blocks



Table of Contents

RED indicates **NEW** information

Vertical Market Product Pages	4-6	Solar Fuse Products	53-70
Alternative energy	4	PVM (600Vdc)	56
Data centers	5	PVCF (600Vac/300Vdc)	57-58
Oil & gas / mining	6	PVS-R (600Vac/dc)	59
Peel and Stick Tabs	11	PV (1000Vdc) 10x38mm	60
Selecting Circuit Protection	12-16	PV (1000/1100Vdc) 14x51mm	61
2011 NEC® guide to fuse selection for various		NH1 (1000Vdc)	62
applications	12-16	XL PV (1000Vdc) XL Size 01, 1, 2, 3	63-65
Low Voltage, Branch Circuit Rated Fuses ..	17-52	PV (1300/1500Vdc) 14x65mm	66
Holders & blocks for branch circuit rated fuses	18-20	XL PV (1200/1500Vdc) XL Size 01, 1, 2, 3	67-69
Dimensions data for branch circuit rated fuses	21-22	Low Voltage Supplementary Fuses	71-84
Class CC		Holders & blocks for supplemental fuses	72-73
LP-CC Low-Peak	23	Cable (K Series) & Welder (64000/68000 Series) Limiters ..	74
FNQ-R CC-Tron	24	¹³ / ₃₂ " x 1 ¹ / ₂ " fast-acting fuses BAF, KTK & KLM	75
KTK-R Limitron	25	¹³ / ₃₂ " x 1 ¹ / ₂ " time-delay fuses FNM & FNQ	76
Class CF		¹³ / ₃₂ " x 1 ³ / ₈ " fast-acting fuses BBS	77
TCF, FCF & WCF CUBEFuse	26-31	Pin indication fuses GBA/GLD, MIC & MIN, FNA,	
CUBEFuse finger-safe holder system	32-33	MIS & KAZ	78-79
Class G		Limiters & blocks ANL & ANN	79
SC	34	In-line size rejecting fuses and holders GLQ, GMQ, HLQ ..	80
Class J		In-line non-rejecting fuses and holders GLR, GMF, GRF,	
LPJ-_SP & LPJ-_SPI Low-Peak	35	HLQ	81
JKS Limitron	36	Automotive blade fuses and holders ATM, ATC, MAX ..	82-83
Class K5 & H		Automotive PCB fuse clips for ATM & ATC	84
NON (250V) & NOS (600V) One time	37	Electronic - PC Board and Small Dimension	
Class L		Fuses	85-98
KRP-C_SP Low-Peak	38-39	5 x 15mm Ferrule fuses C515, C516, C517, C518,	
KRP-CL	39	C519, C520	86
KTU & KLU Limitron	40	5 x 20mm European (IEC) fuses	
Class RK1		S500, S501, S505, S506, GDA, GDB, GDC	87-88
LPN-RK_SP & LPN-RK_SPI (250V) Low-Peak	41-43	5 x 20mm North American (UL) fuses GMA, GMC,	
LPS-RK_SP & LPS-RK_SPI (600V) Low-Peak	41-43	GMD-	89
KTN-R (250V) Limitron	44	¹ / ₄ " Diameter x ⁵ / ₈ " to 1" length ferrule fuses AGA,	
KTS-R (600V) Limitron	45	AGW, AGX	90
Class RK5		¹ / ₄ " Diameter x 1 ¹ / ₄ " length fast-acting ferrule fuses ABC,	
FRN-R (250V) Fusetron (Energy Efficient)	46	AGC, GBB	91
FRS-R (600V) Fusetron (Energy Efficient)	47	¹ / ₄ " Diameter x 1 ¹ / ₄ " length time-delay ferrule fuses MDA,	
Class T		MDL, MDQ	92
JJN (300V) T-Tron	48	PC Board mount fuse holders HTC-, HBH-, HBV-, HBW-,	
JJS (600V) T-Tron	49	FBI, FBM	93-94
Edison & Rejection Base Plug Fuses		PC Board fuseclips HTC-_M, 1A_, 56_	95-98
Plug Fuses (S, SL, T, TL & W)	50-51		
MB Edison Base Circuit Breakers	52		
SA Rejection-base plug fuse adapters	52		

Bussmann circuit protection solutions comply with major industrial standards and agency requirements such as: BS, IEC, DIN, UL, NEMA, CSA, CE, C-UL, etc. and are manufactured at facilities that are ISO 9000 certified.

This catalog is intended to present product data and provide technical information that will help the end user with design application. Bussmann reserves the right, without notice, to change design or construction or any products and to discontinue or limit distribution of any products. Bussmann also reserves the right to change or update, without notice, any technical information contained in this catalog. Once a product has been selected, it should be tested by the user in all possible applications. Further, Bussmann takes no responsibility for errors or omissions contained in this catalog, or for mis-application of any Bussmann product. Extensive product information is available in the Bussmann product data sheets available on line at www.cooperbussmann.com/DatasheetsEle. ©2013 Bussmann

Table of Contents

RED indicates **NEW** information

Medium Voltage Fuses99-120
 Introduction100
 E-Rated fuses for transformers & feeders101-104
E-Rated fuses: CL-14 & bolt-in105-107
 E-Rated fuses for potential & small power
 transformers108-110
 Potential transformer fuses111
 R-Rated fuses for motor circuit protection112-114
 British Standard IEC fuses for motor circuit protection . . .115
 DIN IEC fuses for transformers116
Expulsion Fuse Links117-118
 EEI-NEMA Type K & T, and Type H & N fuses119
 Fuseclips for medium voltage fuses120

High Speed Semiconductor Fuses121-244
 General Applications122-123
 North American fuses and accessories
 DFJ, FWA, FWH, FWJ, FWP, FWX, KAC, KBC,124-141
 Square body fuses and accessories
 DIN 43 620, DIN 43 653, flush-end contact, French Style,
 US Style 170E, 170F, 170H, 170M142-213
 British BS 88 fuses and accessories
 CT, ET, EET, FE, FEE, FM, FMM, LCT, LET, LMMT, LMT,
 MMT, MT214-222
 Ferrule fuses and accessories
 FWA, FWC, FWH, FWJ, FWK, FWL, FWP, FWS,
 FWX223-244

IEC & British Standard Fuses245-264
 Application Data245-246
 CSA Type P and Type D fuses CDN, CDS, PON247
 HRC Form II Class C Tron™ fuses CGL248
 HRCI Industrial ceramic body fuses CIF249
 HRCI-J Fast-acting fuses CJ250
 MRCI-Miscellaneous Type K fuses CIH, CIK, CIL251
 HRC Form II Current-limiting fuses H07C, K07C, L09C,
 L14C, M09C, M14C, P09C, P11C, R11C252
 BS 88 British Standard low voltage fuses AAO, AC, AD,
 BAO, BC, BD, CD, CEO, DD, DEO, ED, EF, EFS, ESD, FF,
 FG, GF, GG, GH, NITD, NSD, OSD, SSD, STD253-254
 DIN Type D and Neozed low voltage fuses D16, D27, D33,
 D125, NZ255
 NH HRC Fuse links & bases NHG256-259
 Class gG/gL IEC 60 269 fuses C08G, C08M, C10G, C10M,
 C14G, C14M, C22G, C22M260-262
 HRC Fuse holders CAMaster, SAFEloc263

Quik-Spec™ Electrical Gear265-272
 Quik-Spec™ Coordination Panelboards266-267
 Quik-Spec™ Power Module™ Elevator Disconnect
 Switches & Panels PS, PMP268-269
 Quik-Spec™ DC Safety Switches BD270
 Quik-Spec™ AC Safety Switches CF271
 HVAC Disconnects B221, B222272

Fuse Holders and Blocks273-322
**CH Series global modular fuse holders - Class CC, midget & metric
 CHCC, CHPV, CHM, CH08, CH14, CH22274-277**
Remote fuse monitoring - CH-PLCCH278
Comb-bus bar specifications and selection guide279
Comb-bus bar features and installation guide280
 CH Series Class J global modular fuse holders CH281
 Optima - fuse holder module and disconnect switch282
 Optima fuse holder module283
 Optima NG 3-pole overcurrent protection module284-285
 Safety J Class J (finger-safe) fuse holder JT, JTN286-287
 SAMI™ fuse covers SAMI288
Modular Knifeblade Fuse Holders289-290
 Class R, H(K), 250 & 600V291-292
 Class J, 600V293
 Class H(K) and R fuse blocks - 250V294-295
 Class H(K) and R fuse blocks - 600V296-297
 Class J fuse blocks J600, JP, JA Add-a-Pole298-299
 Class T fuse blocks - 300V300-301
 Class T fuse blocks - 600V302-303
 Add-on fuse blocks BCA, BMA304
 Class CC, Type M and Class G fuse blocks BC, BCCM,
 BG, BM, G305
 Modular fuse blocks BH306
 Box cover units for plug fuses SCY, SKA, SOU, SOW,
 SOX, SOY, SRU, SRW, SRX, SRY, SSN, SSU, SSW, SSX,
 SSY, STY,307
 In-line fuse holders HFA, HFB, HHB, HHT, HM,
 HR, HRK308-309
Tron™ in-line fuse holders HEB, HEC, HEG, HEH, HEJ, HET,
 HEX, HEY, **HEZ**309-311
 Panel mounted fuse holders (including indicating) HJL, HK,
 HKP, HLD, HPC, HPD, HPF, HPG, HPM, HPS, HPS, HTB,
 HTC312-318
 Fuse blocks for ¼" x 1 ¼" and ¼" x 1" fuses319-320
 Fuse blocks for 13/32" x 1 ½" fuses321
 Rail mount fuse blocks & holders322

Table of Contents

















RED indicates **NEW** information

Power Distribution Blocks323-332	Disconnects379-424
Power Distribution Block Selection Chart324	Compact Circuit Protector (CCP) disconnect switches	
PDBFS Series finger-safe power distribution blocks325	30A Class CC, Midget & 10x38	380-381
PDB Series power distribution blocks326	30A 60A and 100A Class CF	382-383
163 Series power terminal blocks327-328	CCPB - Compact Circuit Protector Base	384-385
Series 11675 & 11725 power terminal blocks329	UL 98 fused disconnect switches 30 to 800A	
Series 160, 162, 163 & 165 power terminal blocks329	Introduction & Agency Information	386
Series 162, 163 & 165 power stud terminal blocks330	Product Line Summary	387
Series 160, 162, 163 & 165 power splicer terminal blocks330	30A Compact Class CC & Class J	388-389
Series 14002 (barrier) & 14004 (dead front) terminal blocks331	30A Class J	390-391
		60A Compact Class J	392-393
		60A Class J	394-395
		100A Class J	396-397
		200A & 400A Class J	398-400
		600A Class J and 800A Class L	402-403
Connectors333-378	UL 98 non-fused disconnect switches 30 to 1200A	
DIN-Rail		Introduction & Agency Information	404
Feed through blocks (DS series)334	Product Line Summary	405
Feed through blocks (DP series)335-336	30A, 60A and 100A Compact	406-407
Mini feed through blocks (DM series)337	100A, 200A and 400A Standard	408-409
Double level blocks (DDP series)338	600A, 800A, 1000A and 1200A Standard	410-411
Disconnect blocks (DG series)339-340	UL 508 non-fused disconnect switches 16 to 80A	
Fuse holder blocks (F520 series)341-342	Introduction and Agency Information	412
Internally jumpered blocks (DDNS series)343	Product Line Summary	413
Test blocks (DTST2 series)343	16A, 25A, 40A, 63A and 80A Standard	414-416
Panel mount blocks344-345	Enclosed UL 98 & UL 508 disconnect switches	
Short-Circuit Current Ratings (SCCRs)346-347	Introduction & Agency Information	417
Top screw-on bridges348	Fused UL 98	
End brackets349	30A to 800A Enclosed Disconnects	418-419
Partition plates349	Non-Fused UL 98	
Jumper slides350	30 to 1200A Enclosed Disconnects	420-421
Top insertion bridges350	Non-Fused UL 508	
Side insertion bridges351-352	16 to 80A Enclosed Disconnects	422-423
Mounting rails and brackets353	Fused, dead front disconnect switches	424
Marking system354		
Marking labels355-357	Telecom Protection Devices425-439
Feed through blocks (NDN series)358-359	Telpower compact fused disconnect switch426
Feed through blocks (C-Rail series)360-361	Telpower miniature fused disconnect switch427
Depluggable blocks362-363	Fused disconnect switches for TPA fuses428-429
Multi-pole panel mount blocks364	Fused disconnect switches for TPS fuses430
Quick connect blocks365	Fused disconnect switches431-437
		Telpower specialty fuses438-439
Panel Mount		Surge Protective Devices (SPD)441-460
Series TB100 2- to 36-Pole blocks366-367	SurgePOD HEAVY DUTY SPD442-445
Series TB200 & TB200HB 2- to 30-Pole blocks368-369	SurgePOD PRO SPD446-448
Series TB300 & TB345 2- to 24-Pole blocks370-371	UL DIN-Rail - High SCCR SPDs	
Marking options and covers for double row series372	1-Pole, Type 2, BSPM_S2G449-450
Top & bottom marking strips for terminal blocks373	2-Pole, Type 2, BSPM_S3G451-452
Series TB400 2- to 12-Pole blocks374		
Series KU 2- to 12-Pole panel mount blocks375		
Series C7021 1- to 6-Pole block376		
Series C7024 1- to 12-Pole block377		

Table of Contents

RED indicates **NEW** information

Surge Protective Devices (SPD) - (Continued)
 3-Pole, Type 2, BSPM_WYG/DLG453-454
 4-Pole, Type 2, BSPM_WYNG/HLG455-456
UL DIN-Rail - Low Voltage AC/DC Power
 1-Pole, Type 2, BSPM_LV457-458
UL DIN-Rail - Low Voltage AC/DC Control
 2-Pole, Type 3, BSPH2A_LV459-460
IEC DIN-Rail - Class I
 2-Pole, Class I, BSPS_TN/TT461-462
 3-Pole, Class I, BSPS_TNC463-464
 4-Pole, Class I, BSPS_TNS/TT465-466
IEC DIN-Rail - Class II
 1-Pole, Class II, BSPM_TN / BSPG_NPE467-468
 2-Pole, Class II, BSPM_TN / BSPH_TT469-470
 3-Pole, Class II, BSPM_TNC471-472
 4-Pole, Class II, BSPM_TNS / BSPH_TT473-474
PV DIN-Rail - Lightning Arrester
 1-Pole, PV Advance Lightning Arrester / BSPS_PV ...475-476
PV DIN-Rail - SPDs
 2-Module, PV HEAVY DUTY SPD / BSPH2_PV477-478
 3-Module, PV HEAVY DUTY SPD / BSPH_YPV479-480
 3-Module, PV PRO SPD / BSPP_YPV481-482
Wind Power DIN-Rail - Class I
 1-Pole, Class I, BSPS_WE483-484
Wind Power DIN-Rail - Class II
 1-Pole, Class II, BSPM_WE / BSPS_WE485-486
 2-Pole, Class II, BSPM_WE / BSPH_WE487-488
 3-Pole, Class II, BSPM_WE489-490
 4-Pole, Class II, BSPM_WE / BSPH_WE491-492
 UL 4978 Data Signals SPDs493-501
 SurgePOD™ Series, 150 to 550Vac MCOV502-503
 DIN-Rail TVS Series with holder504
Accessories505-512
 Bussmann service kits and assortments506-508
 Clip clamps and rail adapters (DIN & American)509
 Spare fuse holders, pullers, testers and cabinets510
 Fuse reducers and dummy "neutrals"511
Services & Application Guide513
 Testing514
 Custom Products515
Application Guide516-525
 Bussmann fuse technology516-522
 Motor Circuit Branch Circuit Protection523
 Glossary524-526
 Out-of-Stock Substitutions/Upgrades526
 Commercial & industrial fuse applications527
 FUSEFinder cross reference528
 FC² Mobile App530
Index by Part Number532-537
 Low-Peak UpgradeInside back cover

Catalog Sections	Page
 Low Voltage, Branch Circuit Rated Fuses...	17
 Solar Fuse Products.....	53
 Low Voltage Supplementary Fuses	71
 Electronic - PC Board and Small Dimension Fuses	85
 Medium Voltage Fuse and Fuse Links	99
 High Speed Fuses.....	121
 IEC & British Standard Fuses	245
 Quik-Spec™ Electrical Gear	265
 Fuse Holders and Blocks	273
 Power Distribution & Terminal Blocks	323
 Connectors	333
 Disconnects.....	379
 Telecom Protection Devices (SPD)	425
 Surge Protective Devices.....	441
 Accessories	503
 Services & Application Guide	511
 Index by Part Number	532

PEEL & STICK TABS

Mark the products that are important to you.

Low Voltage Branch Circuit	Low Voltage Branch Circuit
Solar Products	Solar Products
Low Voltage Supplementary	Low Voltage Supplementary
Electronic Fuses	Electronic Fuses
Medium Voltage Fuses	Medium Voltage Fuses
High Speed Fuses	High Speed Fuses
IEC & British Standard Fuses	IEC & British Standard Fuses
Quik-Spec™ Electrical Gear	Quik-Spec™ Electrical Gear

Fuse Holders & Blocks	Fuse Holders & Blocks
Power Distribution & Terminal Blocks	Power Distribution & Terminal Blocks
Connectors	Connectors
Disconnects	Disconnects
Telecom Protection Devices	Telecom Protection Devices
Surge Protection Devices	Surge Protection Devices
Accessories	Accessories
Services & Application Guide	Services & Application Guide

Index by Part Number	Index by Part Number
New Product	New Product
New Product	New Product
New Product	New Product
<p>Write Your Own Descriptions Here</p> 	

Selecting Circuit Protection

The following fuse selection guides are based on the 2011 NEC® and provided fuse recommendations for the various applications listed.

These are only suggestions. Final fuse selection should be performed only by qualified personnel able to fully assess an application's circuit protection requirements. If you need assistance in selecting a fuse for a particular application, call

the Cooper Bussmann Application Engineering team for technical and application support Monday – Friday, 8:00 a.m. – 5:00 p.m. Central Time.

Application Engineering can be reached via phone and e-mail:

- Toll-free phone: 855-287-7626 (855-BUSSMANN)
- E-mail: fusetech@cooperindustries.com

Ballasts

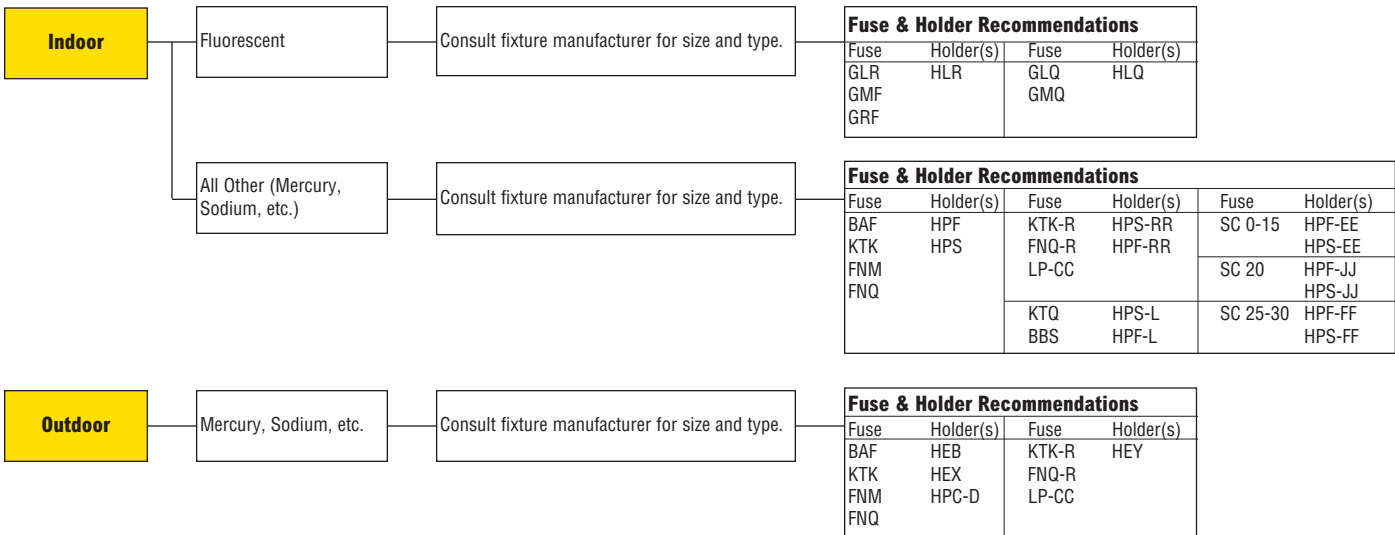

Capacitors (NEC® 460)

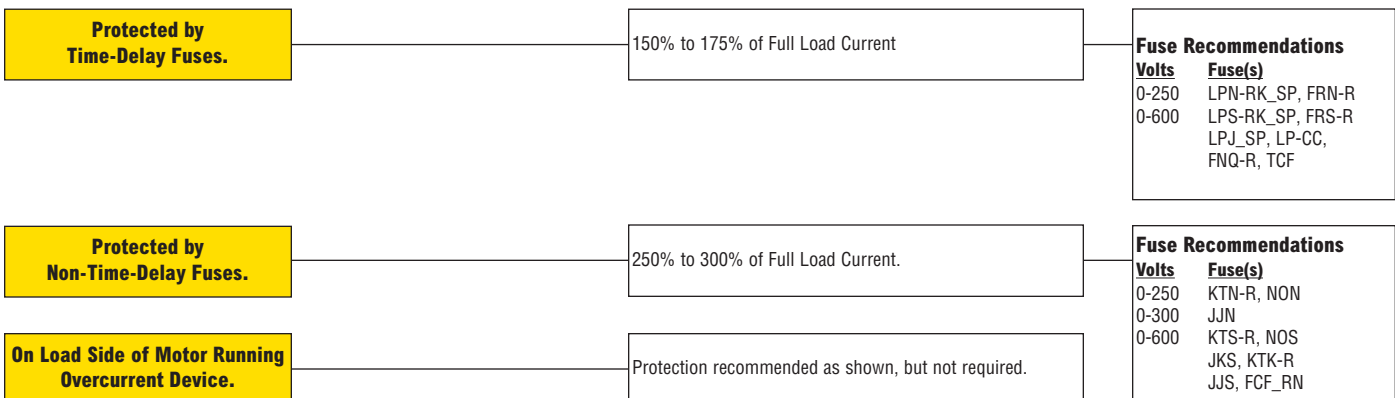

Selecting Circuit Protection

Electric Heat (NEC® 424)

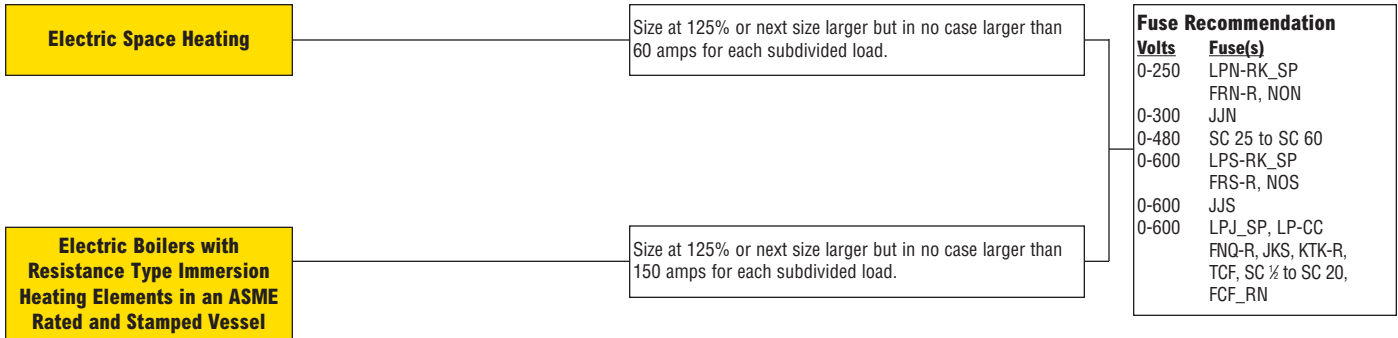

Mains, Feeders, Branches (NEC® 430)

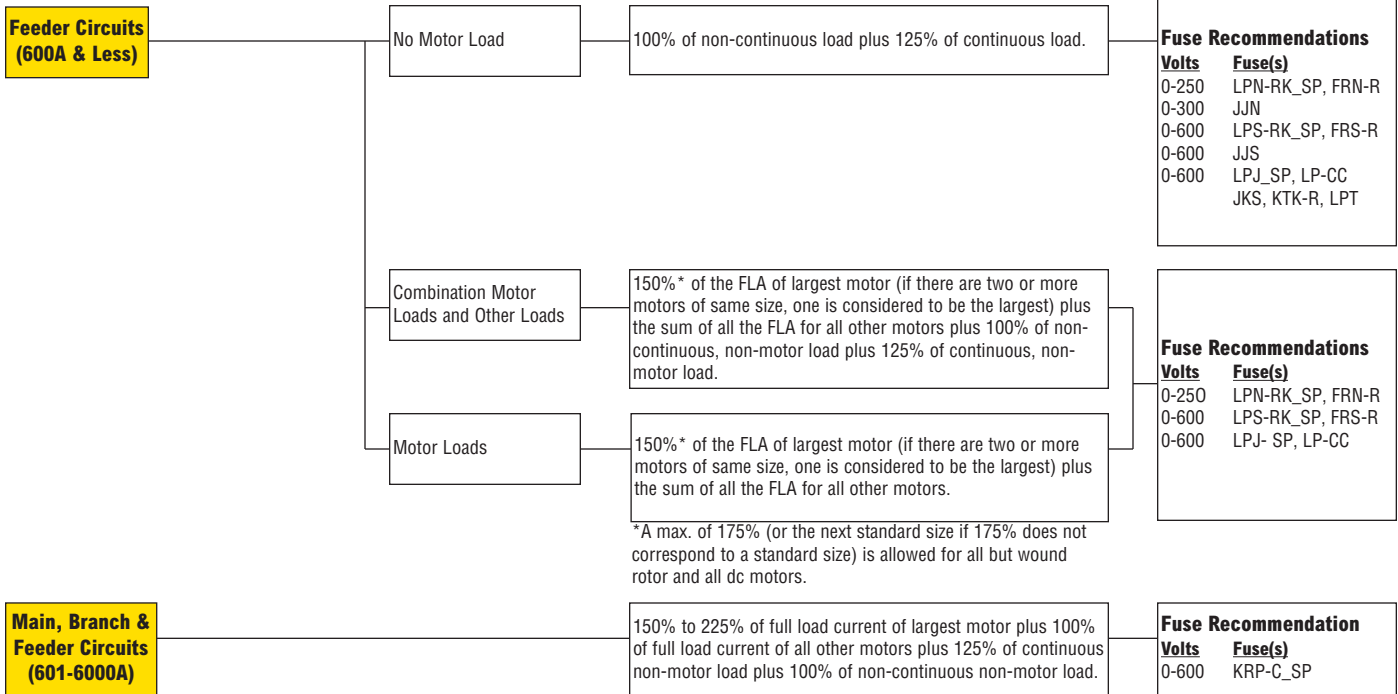

Selecting Circuit Protection

Motor Loads (NEC® 430)

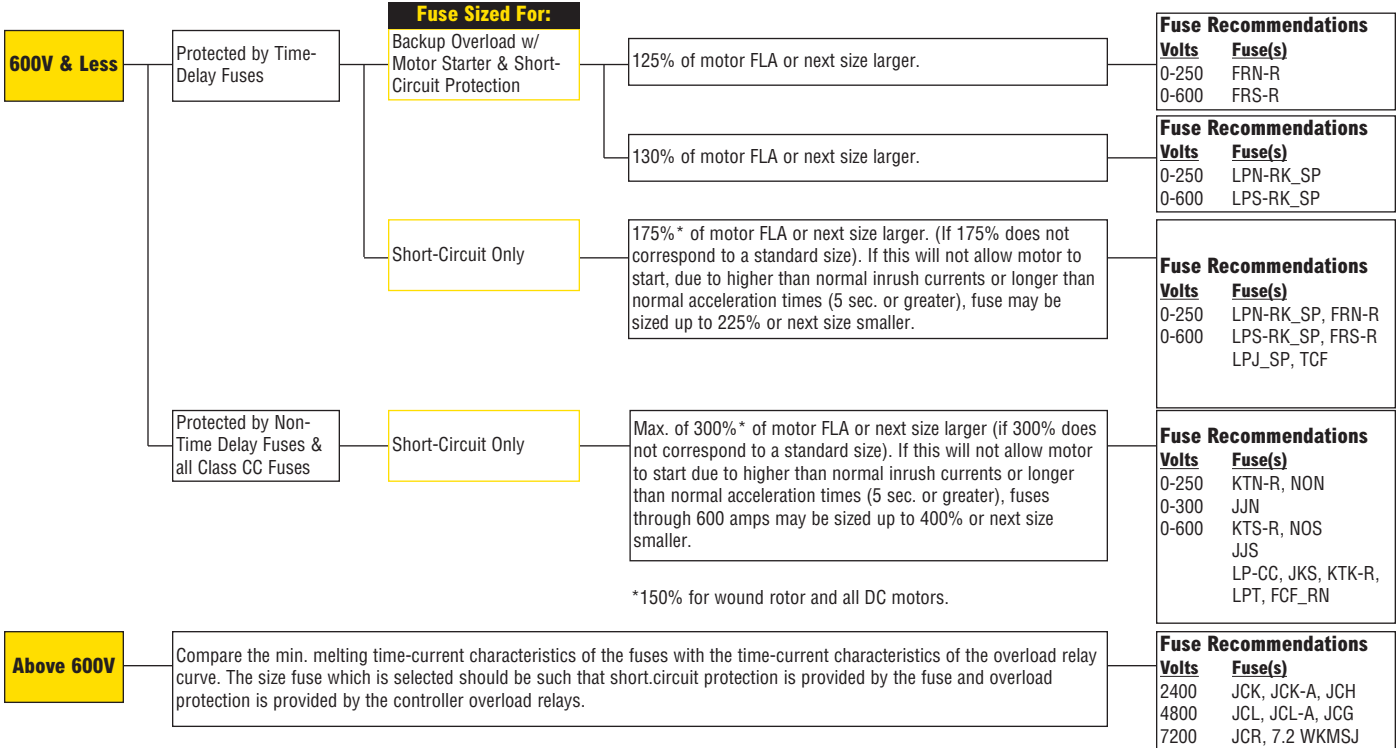

Solenoids (Coils)

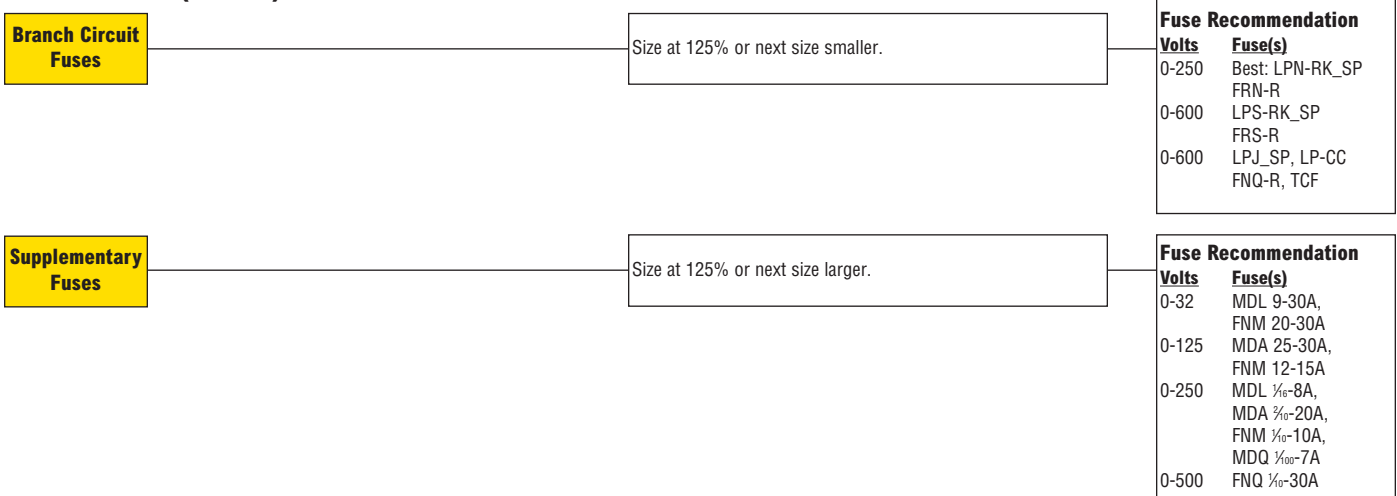

Selecting Circuit Protection

Transformers 600V Nominal or Less (NEC® 450.3)

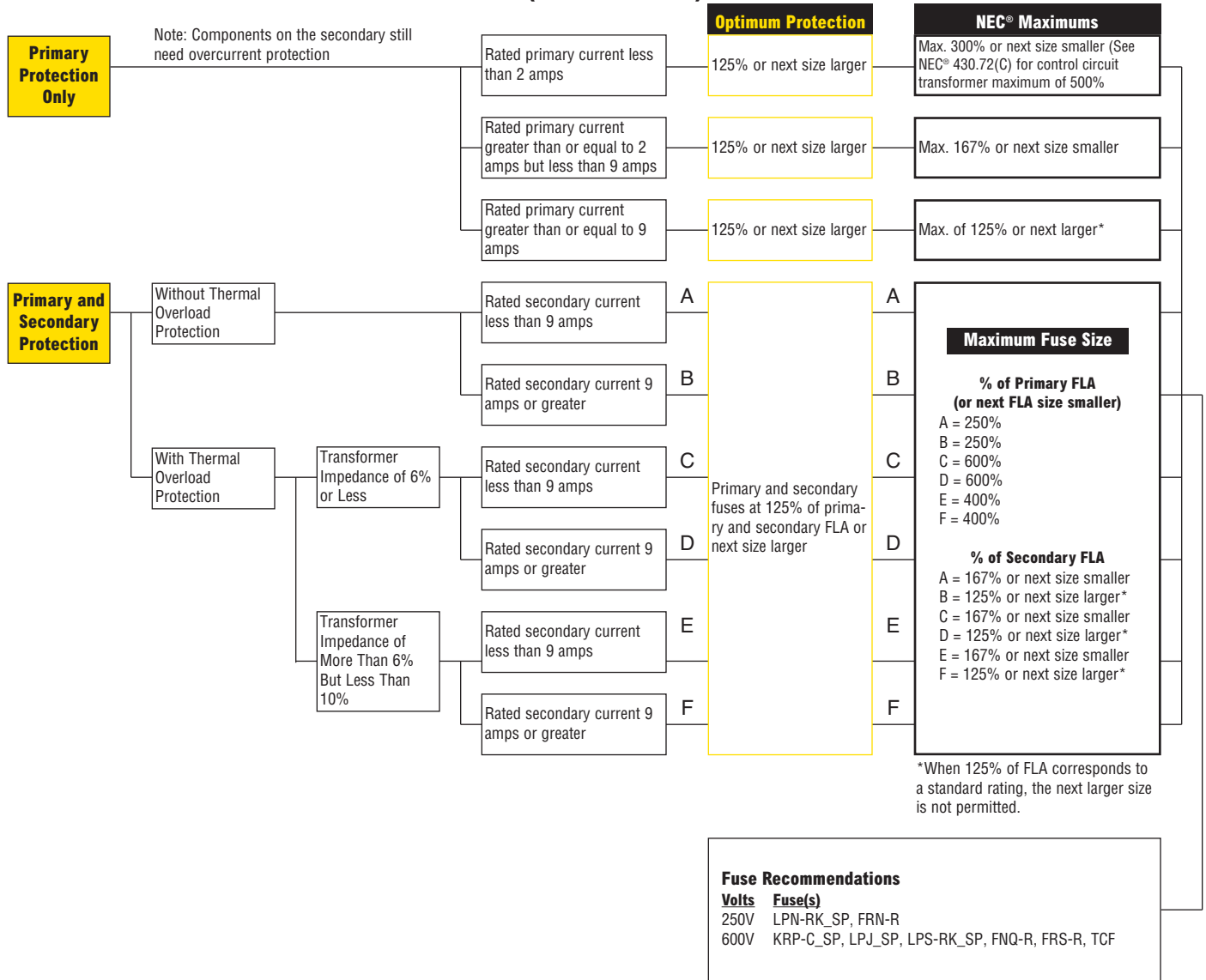

Selecting Circuit Protection

Transformers Over 600V Nominal (NEC® 450.3)

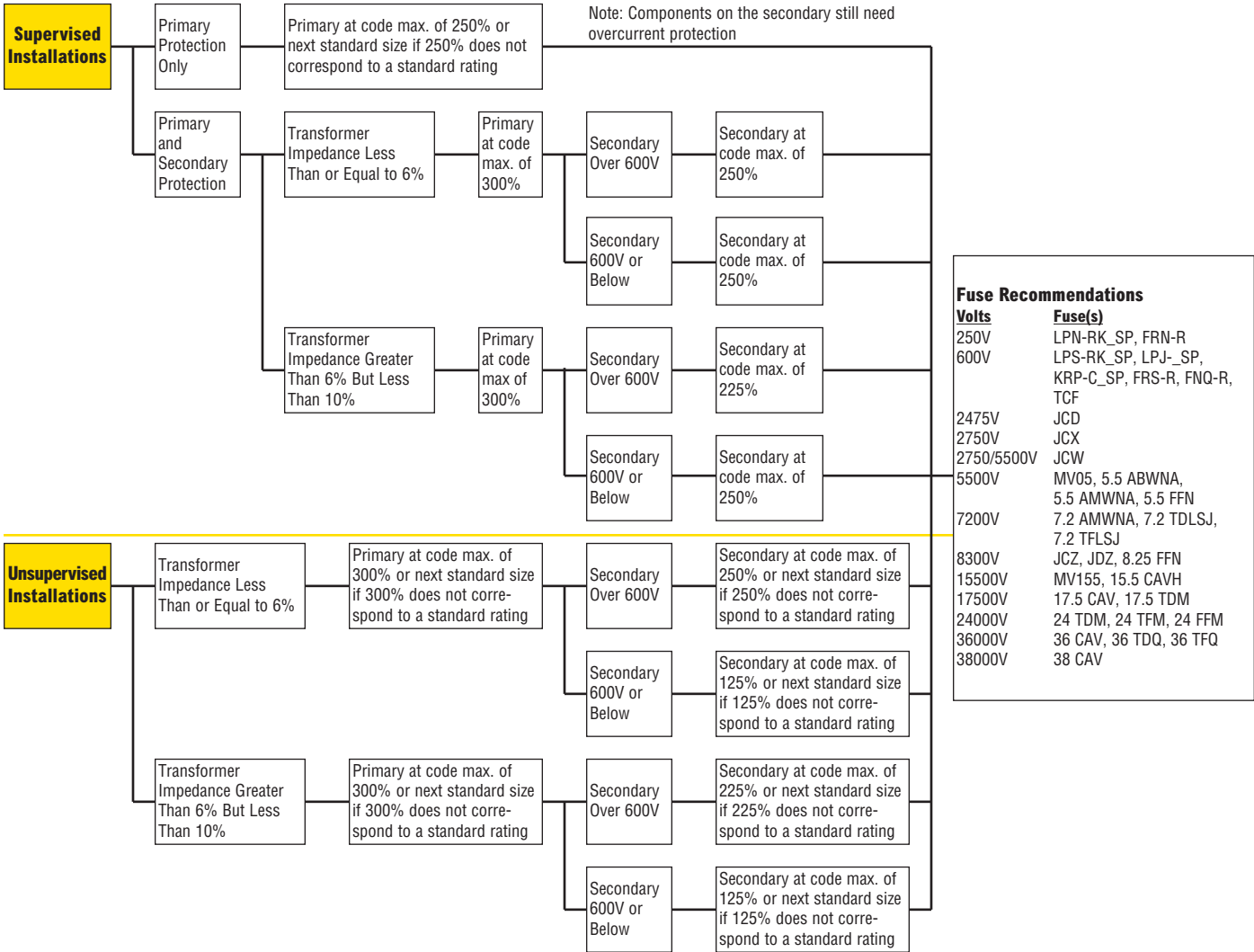

Solid State Devices (Diodes, SCRs, Triacs, Transistors)

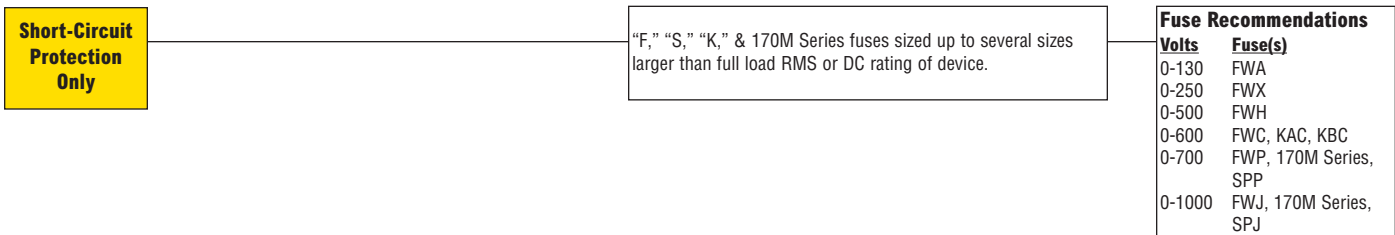

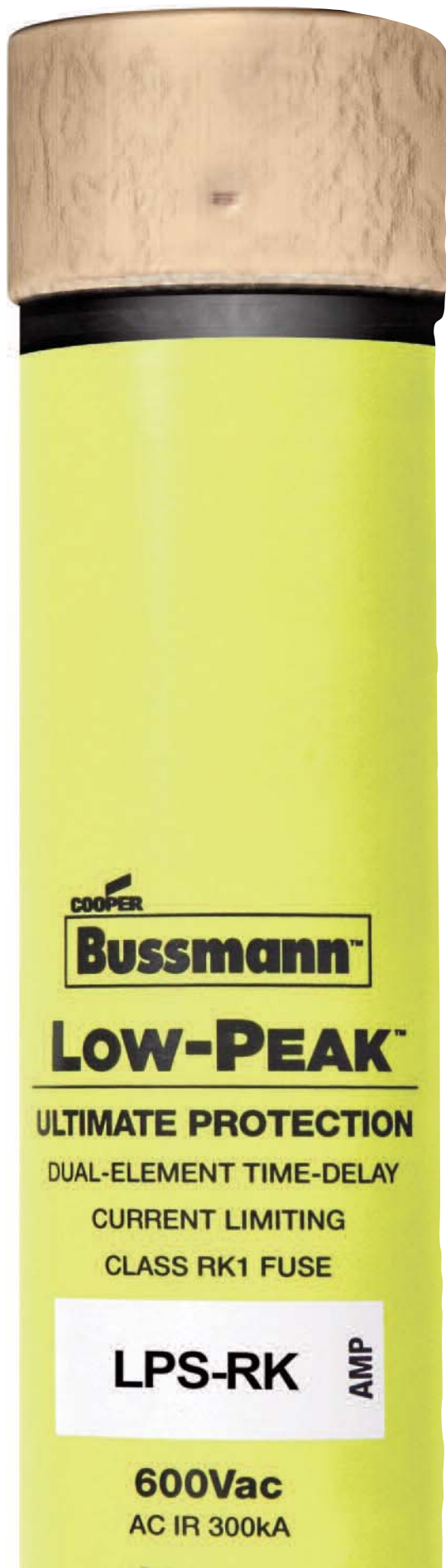

Low Voltage, Branch Circuit Rated Fuses

Fuse Holder & Block Selection Guide	Page 18-20
Class Fuse Dimensions	21-22
Fuses By Fuse Class	

<u>Class</u>	<u>Fuses</u>	<u>Volts</u>	
CC	LP-CC	600V	23
	FNQ-R	600V	24
	KTK-R	600V	25
CF	TCF*	600V	26-27
	FCF	600V	28-29
	WCF	600V	30-31
<small>*Class J performance</small>			
CF	Holder System	600V	32-33
G	SC	600/480V ..	34
J	LPJ-SP	600V	35
	LPJ-SPI Indicator	600V	35
	JKS	600V	36
K5 & H ...	NON	250V	37
	NOS	600V	37
L	KRP-C_SP	600V	38-39
	KRP-CL	600V	39
	KLU	600V	40
	KTU	600V	40
RK1	LPN-RK_SP	250V	41-43
	LPN-RK_SPI Indicator ...	250V	41-43
	LPS-RK_SP	600V	41-43
	LPS-RK_SPI Indicator ...	600V	41-43
	KTN-R	250V	44
	KTS-R	600V	45
RK5	FRN-R (Energy Efficient) ...	250V	46
	FRN-R_ID (Energy Efficient)...	600V	46
	FRS-R (Energy Efficient) ...	600V	47
	FRS-R_ID (Energy Efficient)...	600V	47
T	JJN	300V	48
	JJS	600V	49
Plug Fuses	W, SL, TL, S, T, P, TC Series & MB Edison Base Circuit Breakers, SA	125V	50-52

RED indicates **NEW** information

Holders & Blocks For Branch Circuit Rated Fuses

Class	Fuses	Volts	Page
CC	LP-CC	600V	23
	FNQ-R	600V	24
	KTK-R	600V	25

Holders

- OPM-NG-SC3 3-pole, panel/DIN rail mount 284
- OPM-1038R 3-pole, panel/DIN rail mount 283
- OPM-1038RSW 3-pole w/ switch, panel/DIN rail mount .. 282
- CHCC_D 1 to 3-pole, DIN rail mount 274
- HPF-RR, front panel mount 317
- HPS-RR, front panel mount 317

Blocks

- BC Series, panel mount 305



OPM-NG-SC3



OPM-1038R &
OPM-1038RSW



CHCC_D



HPF-RR



HPS-RR



BC Series

Class	Fuses	Volts	Page
G	SC	600/480V	34

Holders

- HP Series front panel accessible, front panel mount 317

Blocks

- BG Series, panel/DIN rail with adapters 305
- G Series, panel/DIN rail with adapters 305



HP Series



BG & G Series

Class	Fuses	Volts	Page
K5 & H	NON	250V	37
	NOS	600V	37

Blocks

- Modular Knifeblade Fuse Blocks 250/600V, panel mount .. 289
- Modular Type Fuse Blocks 250/600V, panel mount 306
- H250 Series 1 to 3-pole 250V, panel mount 294
- H600 Series 1 to 3-pole 600V, panel mount 296



Modular Knifeblade



Modular Type



H250 Series



H600 Series

Holders & Blocks For Branch Circuit Rated Fuses

Class	Fuses	Volts	Page
L	KRP-C_SP	600V	38
	KRP-CL	600V	39
	KLU	600V	40
	KTU	600V	40

Blocks

- 51215 1-pole, panel mount*
- 51235 3-pole, panel mount*

*Call our customer satisfaction team at 636-527-3877 for more information.



51215



51235

Low Voltage
Branch Circuit
Fuses

Class	Fuses	Volts	Page
RK1	LPN-RK_SP	250V41
	LPS-RK_SP	600V41
	KTN-R	250V44

Blocks

- **Modular Knifeblade Fuse Blocks 250/600V, panel mount . . . 289**
- R250 Series 1- to 3-pole 250V, panel mount294
- R600 Series 1- to 3-pole 600V, panel mount296



Modular Knifeblade



R250 Series



R600 Series

Class	Fuses	Volts	Page
RK5	FRN-R	250V	46

Blocks

- **Modular Knifeblade Fuse Blocks 250/600V, panel mount . . . 289**
- R250 Series 1- to 3-pole 250V, panel mount294
- R600 Series 1- to 3-pole 600V, panel mount296



Modular Knifeblade



R250 Series



R600 Series

Class	Fuses	Volts	Page
T	JJN	300V	48
	JJS	600V	49

Blocks

- BH Series modular-style, panel mount (<60A)306
- T300 Series 1 to 4-pole 300V, panel mount300
- T600 Series 1 to 3-pole 600V, panel mount302



BH Series



T300 Series



T600 Series

Holders & Blocks For Branch Circuit Rated Fuses

Class	Fuses	Volts	Page
J, CF	TCF*, FCF, WCF	600V	31
	LPJ-SP	600V	35
	JKS	600V	36

*Class J performance

Holders

- TCFH CUBEFuse holder, panel/DIN-Rail mount 32-33
- CH Series Class J modular 1- to 3-pole, panel/ DIN rail mount 281
- Safety J™ Series modular holders, panel/DIN rail mount 286

Blocks

- Modular Knifeblade Fuse Blocks 250/600V, panel mount . . . 289
- Modular Type Fuse Blocks 600V, panel mount 306
- J600 Series, panel mount 298
- JP Series pyramid blocks, panel mount 299
- BH Series modular-style open blocks, panel mount 306



Class	Fuses	Volts	Page
Plug Fuses	W, SL*, TL, S*, T, P and TC Series	125V	50-52

Box Cover Units

- Standard electrical box mounting 307

*Use of SL & S rejection fuses requires SA adapters, see page 52



Fuse Reducers For Class R Fuses 250V

Equipment Fuse Clip Amps	Desired Fuse (Case) Amp Size	Catalog No. (Pairs) 250V
60	30	NO.263-R
100	30	NO.213-R
	60	NO.216-R
200	60	NO.226-R
	100	NO.2621-R
400	100	NO.2641-R
	200	NO.242-R
600	100	NO.2661-R
	200	NO.2662-R
	400	NO.2664-R*

*Single reducer only (pair not required).

Fuse Reducers For Class R Fuses 600V

Equipment Fuse Clip Amps	Desired Fuse (Case) Amp Size	Catalog No. (Pairs) 600V
60	30	NO.663-R
100	30	NO.216-R
	60	NO.616-R
200	60	NO.626-R
	100	NO.2621-R
400	100	NO.2641-R
	200	NO.642-R
600	100	NO.2661-R
	200	NO.2662-R
	400	NO.2664-R*

*Single reducer only (pair not required).

Branch Circuit Rated Fuse Dimensions

Class J Dimensions - in (mm)

Low-Peak and Limitron Fuses LPJ & JKS — 600V

Amp Range	A	B	C	D	E	F	G	H	I
1-30	2.25 (57.2)	0.81 (20.6)	—	—	0.50 (12.7)	—	—	—	—
35-60	2.38 (60.3)	1.06 (27.0)	—	—	0.63 (15.9)	—	—	—	—
65-100	4.63 (117.5)	1.13 (28.6)	3.63 (92.1)	2.63 (66.7)	1.00 (25.4)	0.75 (28.6)	0.13 (3.2)	0.41 (10.4)	0.28 (7.1)
110-200	5.75 (146.1)	1.63 (41.4)	4.38 (111.1)	3.00 (76.2)	1.38 (34.9)	1.13 (28.6)	0.19 (4.8)	0.38 (9.5)	0.28 (7.1)
225-400	7.12 (181.0)	2.11 (53.6)	5.25 (133.3)	3.26 (82.8)	1.87 (47.6)	1.62 (41.2)	0.25 (6.4)	0.56 (14.2)	0.40 (10.3)
450-600	8.00 (203.2)	2.60 (66.0)	6.00 (152.4)	3.31 (84.0)	2.12 (54.0)	2.00 (50.8)	0.53 (13.5)	0.72 (18.3)	0.53 (13.5)

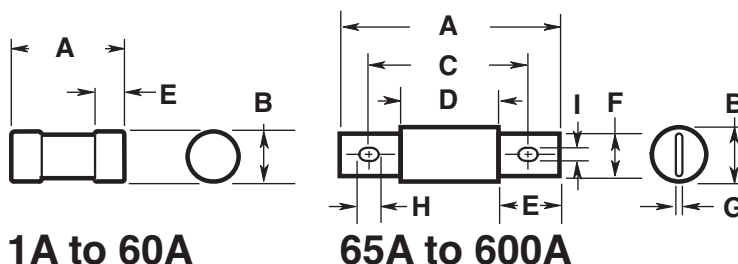

1A to 60A

65A to 600A

Class CC Dimensions - in (mm)

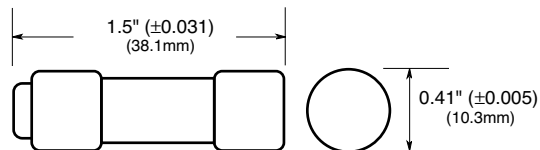

Class RK1 & RK5 Dimensions - in (mm)

Basic dimensions are same as Class H (formerly NEC) One-Time (NON & NOS) and Superlag Renewable RES & REN fuses.
NOTE: These fuses can be used to replace existing Class H, RK1 and RK5 fuses relating to dimensional compatibility.

Ferrule Styles

Amp Range	250V		600V	
	A	B	A	B
1/10-30	2 (50.8)	0.56 (14.3)	5.0 (127.0)	0.81 (20.6)
35-60	3 (76.2)	0.81 (20.6)	5.5 (139.7)	1.06 (27.0)

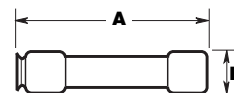

Fusetron — (FRN-R & FRS-R) & Limitron — (KTN-R & KTS-R)

Amp Range	250V		600V	
	A	B	A	B
70-100	5.88 (149.2)	1.06 (26.9)	7.88 (200.0)	1.34 (34.0)
110-200	7.13 (181.0)	1.56 (39.6)	9.63 (244.5)	1.84 (46.7)
225-400	8.63 (219.1)	2.38 (60.5)	11.63 (295.3)	2.59 (65.8)
450-600	10.38 (263.5)	2.88 (73.2)	13.38 (339.7)	3.13 (79.5)

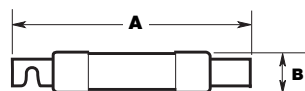

Low-Peak — (LPN-RK & LPS-RK)

Amp Range	250V		600V	
	A	B	A	B
70-100	5.88 (149.2)	1.16 (29.5)	7.88 (200.0)	1.16 (29.5)
110-200	7.13 (181.0)	1.66 (42.2)	9.63 (244.5)	1.66 (42.2)
225-400	8.63 (219.1)	2.38 (60.5)	11.63 (295.3)	2.38 (60.5)
450-600	10.38 (263.5)	2.88 (73.2)	13.38 (339.7)	2.88 (73.2)

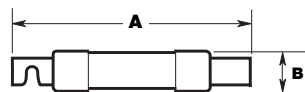

Branch Circuit Rated Fuse Dimensions

Class L Dimensions - in (mm)

Low-Peak and Limitron Fuses

Amp Range	A	B	C1	C2	D	F	G	I	J1	J2	J3	J4
601-800	8.63 (219.1)	2.40 (61.0)	6.75 (171.5)	5.75 (146.1)	3.75 (95.3)	2.00 (50.8)	0.38 (9.5)	0.63 (15.9)	—	—	—	—
801-1200	10.75 (273.1)	2.40 (61.0)	6.75 (171.5)	5.75 (146.1)	3.75 (95.3)	2.00 (50.8)	0.38 (9.5)	0.63 (15.9)	—	—	—	—
1350-1600	10.75 (273.1)	3.00 (76.2)	6.75 (171.5)	5.75 (146.1)	3.75 (95.3)	2.38 (60.3)	0.44 (11.1)	0.63 (15.9)	—	—	—	—
1800-2000	10.75 (273.1)	3.50 (88.9)	6.75 (171.5)	5.75 (146.1)	3.75 (95.3)	2.75 (69.9)	0.50 (12.7)	0.63 (15.9)	—	—	—	—
2001-2500	10.75 (273.1)	4.80 (122.0)	6.75 (171.5)	5.75 (146.1)	3.75 (95.3)	3.50 (88.9)	0.75 (19.1)	0.63 (15.9)	1.75 (44.5)	1.38 (34.9)	0.88 (22.2)	0.81 (20.6)
3000	10.75 (273.1)	5.00 (127.0)	6.75 (171.5)	5.75 (146.1)	3.75 (95.3)	4.00 (101.6)	0.75 (19.1)	0.63 (15.9)	1.75 (44.5)	1.38 (34.9)	0.88 (22.2)	0.81 (20.6)
3500-4000	10.75 (273.1)	5.75 (146.1)	6.75 (171.5)	5.75 (146.1)	3.75 (95.3)	4.75 (120.7)	0.75 (19.1)	0.63 (15.9)	1.75 (44.5)	1.38 (34.9)	1.63 (41.3)	0.88 (22.2)
4500-5000	10.75 (273.1)	6.25 (158.8)	6.75 (171.5)	5.75 (146.1)	3.75 (95.3)	5.25 (133.4)	1.00 (25.4)	0.63 (15.9)	1.75 (44.5)	1.38 (34.9)	1.63 (41.3)	0.88 (22.2)
6000	10.75 (273.1)	7.13 (181.0)	6.75 (171.5)	5.75 (146.1)	3.75 (95.3)	5.75 (146.1)	1.00 (25.4)	0.63 (15.9)	1.75 (44.5)	1.38 (34.9)	1.63 (41.3)	0.88 (22.2)

NOTE: KRP-CL (150A to 600A) fuses have same dimensions as 601-800A case size. KTU (200-600A) have same dimensions, except tube 3" length x 2" diameter (76.2 x 50.8mm); terminal 1 1/8" width x 1 1/4" thick (41.3 x 31.8mm).

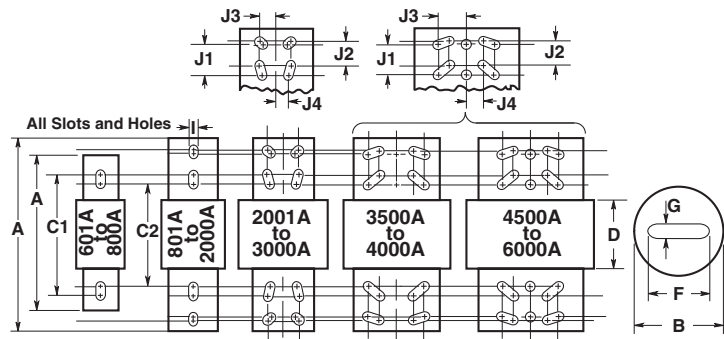

Class T Dimensions - in (mm)

T-Tron Fuses

JJN — 300V

Amp Range	A	B	C	D
1-30	0.88 (22.2)	0.41 (10.3)	—	—
35-60	0.88 (22.2)	0.56 (14.3)	—	—
70-100	2.16 (54.8)	0.75 (19.1)	1.56 (39.7)	0.84 (21.4)
110-200	2.44 (61.9)	0.88 (22.2)	1.69 (42.9)	0.84 (21.4)
225-400	2.75 (69.9)	1.00 (25.4)	1.84 (46.8)	0.86 (21.8)
450-600	3.06 (77.8)	1.25 (31.8)	2.03 (51.6)	0.88 (22.2)
601-800	3.38 (85.7)	1.75 (44.5)	2.22 (56.4)	0.89 (22.6)
801-1200	4.00 (101.6)	2.00 (50.8)	2.53 (64.3)	1.08 (27.4)

JJS — 600V

Amp Range	A	B	C	D
1-30	1.50 (38.1)	0.56 (14.3)	—	—
35-60	1.56 (39.7)	0.81 (20.6)	—	—
70-100	2.95 (75.0)	0.75 (19.1)	2.36 (59.9)	1.64 (41.7)
110-200	3.25 (82.6)	0.88 (22.2)	2.50 (63.5)	1.66 (42.1)
225-400	3.63 (92.1)	1.00 (25.4)	2.72 (69.1)	1.73 (44.1)
450-600	3.98 (101.2)	1.25 (31.8)	2.96 (75.0)	1.78 (45.2)
601-800	4.33 (109.9)	1.75 (44.5)	3.17 (80.6)	1.88 (47.6)

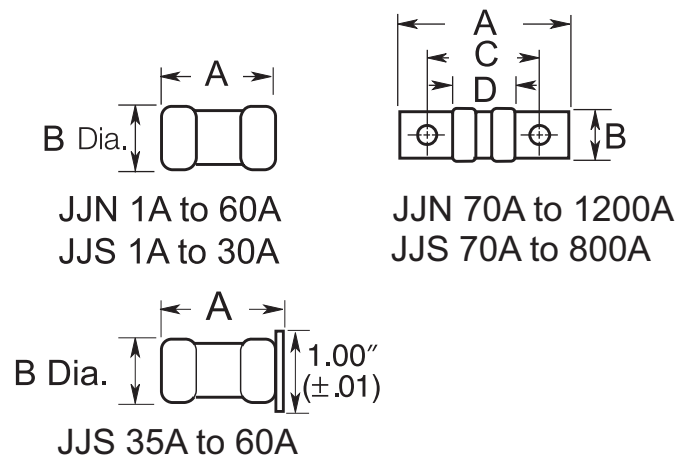

Low-Peak™ Time-delay, Rejection-Type Fuses

LP-CC Class CC

Specifications

Description: Time-delay, current-limiting, rejection-type fuse – 12 seconds (minimum) at 200% rated amps.

Dimensions: 1 3/32" x 1 1/2" (10.3 x 38.1mm).

Ratings:

- Volts — 600Vac (or less)
- 300Vdc (1/2-2 1/2A & 20-30A)
- 150Vdc (2 3/4-15A)
- Amps — 1/2-30A
- IR — 200kA RMS Sym.
- 20kA DC



Agency Information: CE, Std. 248-4, Class CC, UL Listed, Guide JDDZ, File E4273, CSA Certified; Class 1422-02, File 53787.

Features and Benefits

- Time-delay coupled with Class CC current-limiting response provides close sizing on small motor and relay circuits, and maximum component short-circuit current rating protection.
- 200kA interrupting rating provides high ratings for control circuit locations.
- Class CC rejection feature, with appropriate fuse block, prevents inserting lesser-rated supplementary fuses.
- Inventory consolidation of 1 3/32 x 1 1/2 inch supplementary fuses reduces SKU investment and minimizes potential for misapplying fuse.
- Selective coordination ratio of 2:1 (within Low-Peak fuse family) prevents electrical shutdowns from extending beyond the failed circuit.

Typical Applications

- Specialized Circuits
- Industrial Control
- Isolated, In-Line Fuse Holder

Catalog Numbers (Amps)

LP-CC-1/2	LP-CC-2-1/2	LP-CC-7 1/2
LP-CC-3/10	LP-CC-2-3/10	LP-CC-8
LP-CC-3/10	LP-CC-3	LP-CC-9
LP-CC-1	LP-CC-3-3/10	LP-CC-10
LP-CC-1-1/2	LP-CC-3-1/2	LP-CC-12
LP-CC-1-1/4	LP-CC-4	LP-CC-15
LP-CC-1-3/10	LP-CC-4-1/2	LP-CC-20
LP-CC-1-1/2	LP-CC-5	LP-CC-25
LP-CC-1-3/10	LP-CC-5-3/10	LP-CC-30
LP-CC-1-3/10	LP-CC-6	
LP-CC-2	LP-CC-6-1/4	
LP-CC-2-1/4	LP-CC-7	

Time Current Characteristics—Average Melt

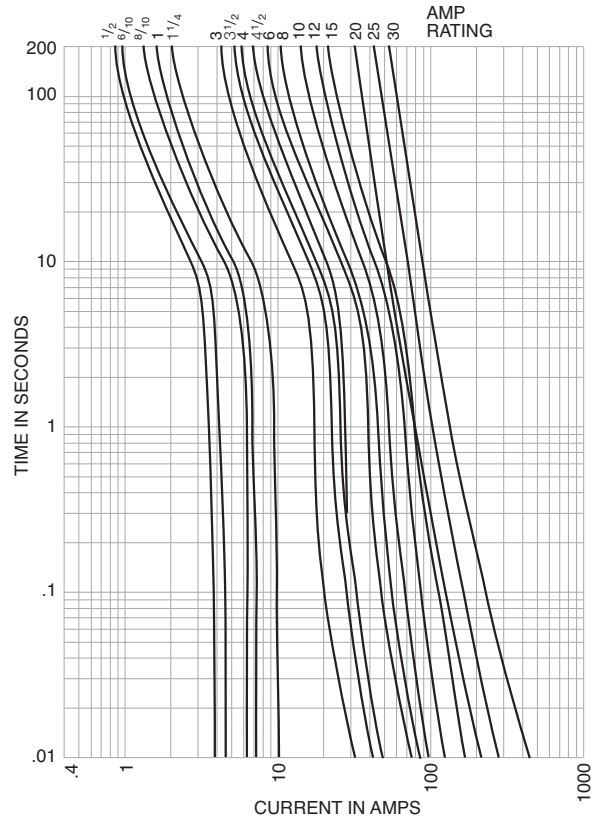

Current Limitation Curves

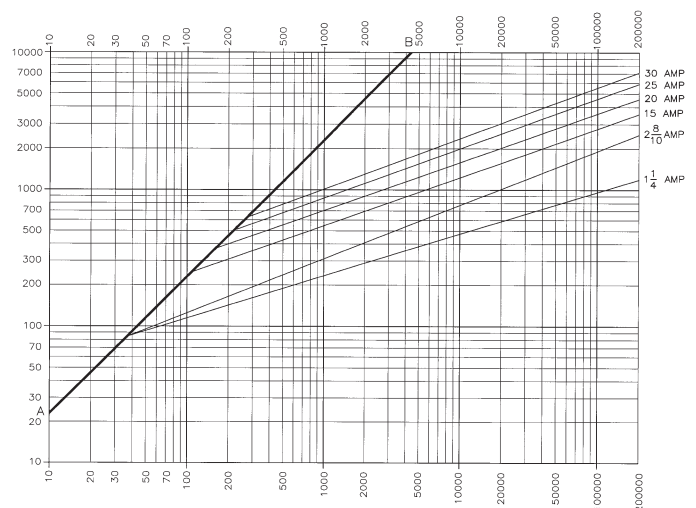

Recommended Fuse Holders & Blocks For Class CC Fuses

- See page 18

CC-Tron Rejection-type Fuses

FNQ-R Class CC

Specifications

Description: Time-delay, branch circuit, rejection-type fuse.

Dimensions: 1³/₃₂" x 1 1/2" (10.3 x 38.1mm).

Ratings:

- Volts — 600Vac (or less)
- 300Vdc (15-20A)
- 32Vdc (Self Certified)

Amps — 1/4-30A

- IR — 200kA RMS Sym.
- 20kA DC (15 & 20A only)

Agency Information: CE, Std. 248-4, Class CC, UL Listed, Guide JDDZ, File E4273 CSA Certified, Class 1422-01, File 53787.

Features and Benefits

- Time-delay compatible with inrush characteristic of small control transformers.
- Current limitation at Class CC levels provides maximum component short-circuit current rating protection.
- 200kA interrupting rating provides high ratings for control circuit locations.
- Class CC rejection feature, with appropriate fuse block, prevents inserting lesser-rated supplementary fuses.

Typical Applications

- Line Protection, Small Control Transformers
- Industrial Control
- Isolated, In-Line Fuse Holders

Catalog Numbers (Amps)

FNQ-R-1/4	FNQ-R-1-3/10	FNQ-R-6
FNQ-R-3/10	FNQ-R-1-1/10	FNQ-R-6-1/4
FNQ-R-1/2	FNQ-R-2	FNQ-R-7
FNQ-R-3/5	FNQ-R-2-1/4	FNQ-R-7-1/2
FNQ-R-1/2	FNQ-R-2-1/2	FNQ-R-8
FNQ-R-3/4	FNQ-R-2-3/10	FNQ-R-9
FNQ-R-1	FNQ-R-3	FNQ-R-10
FNQ-R-1	FNQ-R-3-3/10	FNQ-R-12
FNQ-R-1-1/4	FNQ-R-3-1/2	FNQ-R-15
FNQ-R-1-1/2	FNQ-R-4	FNQ-R-17-1/2
FNQ-R-1-3/10	FNQ-R-4-1/2	FNQ-R-20
FNQ-R-1-1/2	FNQ-R-5	FNQ-R-25
FNQ-R-1-1/2	FNQ-R-5-3/10	FNQ-R-30



Time-Current Characteristic Curves—Average Melt

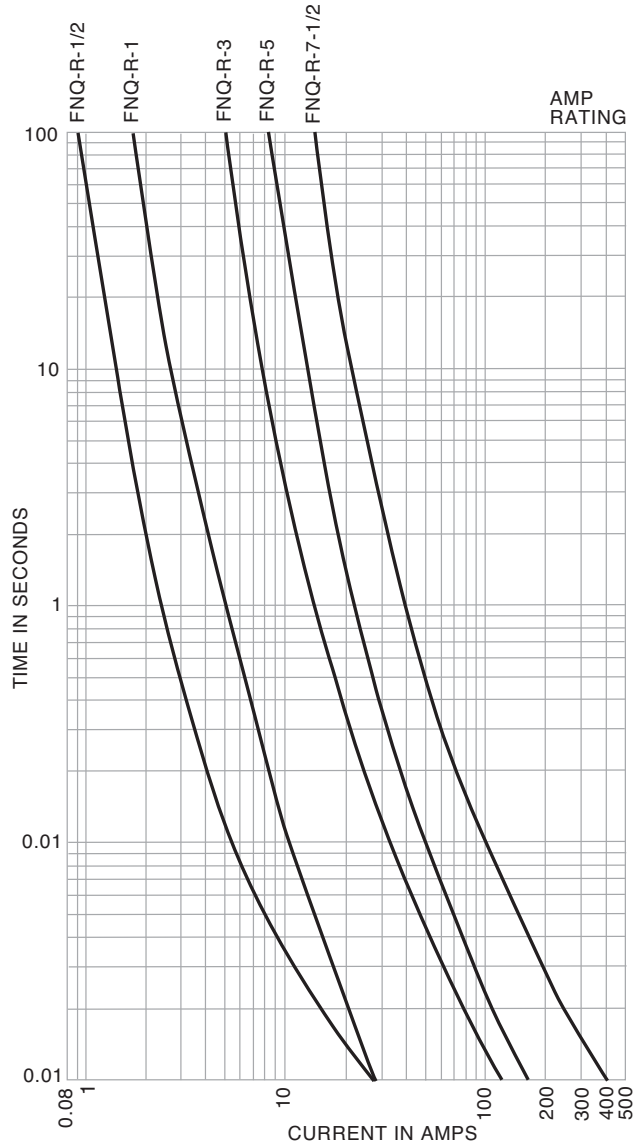

For superior electrical protection, Bussmann recommends upgrading FNQ-R fuse applications to Low-Peak LP-CC fuses See page 17.

Recommended Fuse Holders & Blocks For Class CC 600V Fuses

- See page 18

Limitron™ Rejection-type Fuses

Low Voltage
Branch Circuit
Fuses

KTK-R Class CC

Specifications

Description: Fast-acting, branch circuit, rejection-type fuse.

Dimensions: 1 1/2" x 1 1/2" (10.3 x 38.1mm).

Ratings:

Volts — 600Vac (or less)

Amps — 1/10-30A

IR — 200kA RMS Sym.

Agency Information: CE, Std. 248-4, Class CC, UL Listed, Guide JDDZ, File E4273 CSA Certified, File 53787, Class 1422-02.



Features and Benefits

- Current limitation at Class CC levels provides maximum component short-circuit current protection.
- 200kA interrupting rating provides high ratings for control circuit locations.
- Class CC rejection feature, with appropriate fuse block, prevents inserting lesser-rated supplementary fuses.

Typical Applications

- Specialized Circuits
- Industrial Control
- Isolated, In-Line Fuse Holders (street lighting)

Catalog Numbers (Amps)

KTK-R-1/10	KTK-R-1	KTK-R-7
KTK-R-1/8	KTK-R-1-1/2	KTK-R-8
KTK-R-3/10	KTK-R-2	KTK-R-9
KTK-R-1/4	KTK-R-2-1/2	KTK-R-10
KTK-R-3/8	KTK-R-3	KTK-R-12
KTK-R-1/2	KTK-R-3-1/2	KTK-R-15
KTK-R-5/8	KTK-R-4	KTK-R-20
KTK-R-3/4	KTK-R-5	KTK-R-25
KTK-R-1	KTK-R-6	KTK-R-30

Time-Current Characteristic Curves—Average Melt

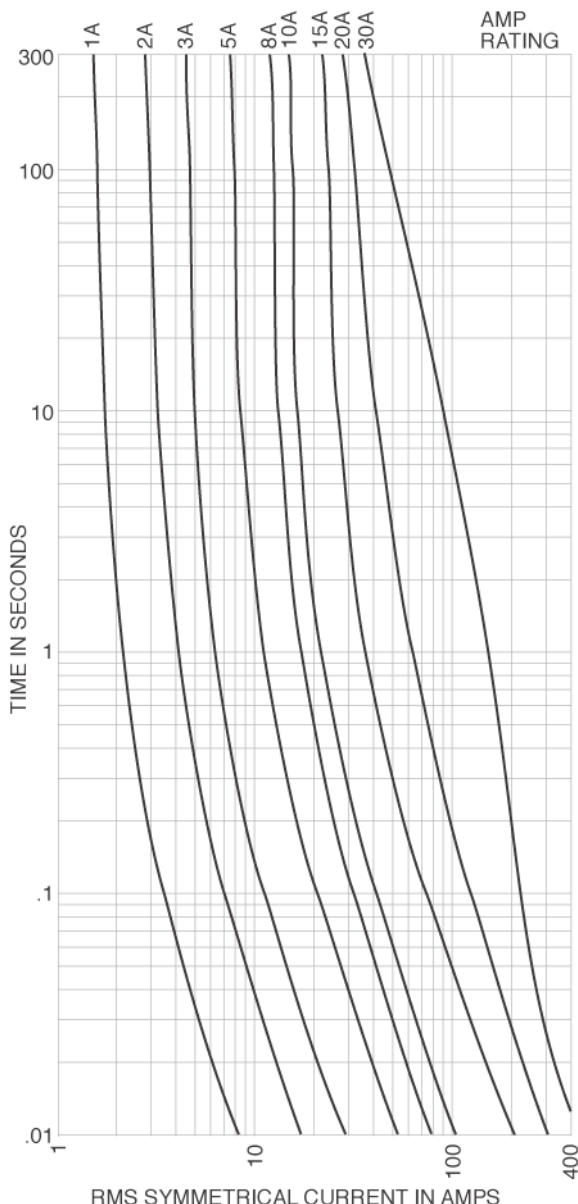

For superior electrical protection, Bussmann recommends upgrading KTK-R fuse applications to Low-Peak LP-CC fuses See page 23.

Recommended Fuse Holders & Blocks For Class CC Fuses

- See page 18

Data Sheet: 1015

Time-Delay Low-Peak CUBEFuse™ Finger-safe Fuse and Fuse Holder System

TCF Class CF



Available With Indication

Specifications

Description: Finger-safe fuse and fuse holder system; dual-element, time-delay fuse; 10 seconds minimum operating time at 500% rated amps.

Dimensions: See Dimensions illustration.

Poles: 1-pole (gangable)

Ratings:

Volts — 600Vac (or less)
— 300Vdc (or less)

Amps — 1-100A

IR — 300kA RMS Sym. (UL)
— 200kA RMS Sym. (CSA)
— 100kA DC (UL & CSA)

Agency Information: CE, UL Listed Guide JFHR, File E4273, CSA Certified Fuse: Class 1422- 02, File 53787, UL Listed Fuse holder: Guide IZND, File E214079, CSA Certified Fuse holder: Class 6225-01, File 47235.

Features and Benefits

- Separate overload and short-circuit elements provide time delay for sizing of high inrush loads linked with Class J current limitation.
- Selective coordination ratio of 2:1 (within Low-Peak fuse family) prevents electrical shutdowns from extending beyond the failed circuit.
- Smallest footprint of any Class CC, J, T or RK fuse provides substantial space savings and installation flexibility.
- IEC 60529 and finger-safe rating provides enhanced workplace safety.

Typical Applications

- Electrical Panelboards
- Machinery Disconnects
- Industrial Control
- Required Finger-Safe Systems

Fuse Catalog Numbers Indicating (Amps)

TCF6	TCF25	TCF50	TCF100
TCF10	TCF30	TCF60	
TCF15	TCF35	TCF70	
TCF17-½	TCF40	TCF80	
TCF20	TCF45	TCF90	

Fuse Catalog Numbers Non-Indicating (Amps)

TCF1RN	TCF17-½RN	TCF40RN	TCF80RN
TCF3RN	TCF20RN	TCF45RN	TCF90RN
TCF6RN	TCF25RN	TCF50RN	TCF100RN
TCF10RN	TCF30RN	TCF60RN	
TCF15RN	TCF35RN	TCF70RN	

Carton Quantity and Weight

Amp Rating	Carton Qty.	Weight Per Carton	
		lbs	kg
TCF1-30A	12	1.39	0.63
TCF35-60A	12	1.42	0.65
TCF70-100A	6	1.74	0.79



Scan this tag to get the latest product information for the TCF CUBEFuse.

Recommended Fuse Holders For Class CF Fuses

- See pages 32 and 33

Data Sheet: 9000 (fuses) and 9007 (holders)

Time-Delay Low-Peak CUBEFuse™ Finger-safe Fuse and Fuse Holder System

Dimensions for CUBEFuse Fuse and Fuse Holder

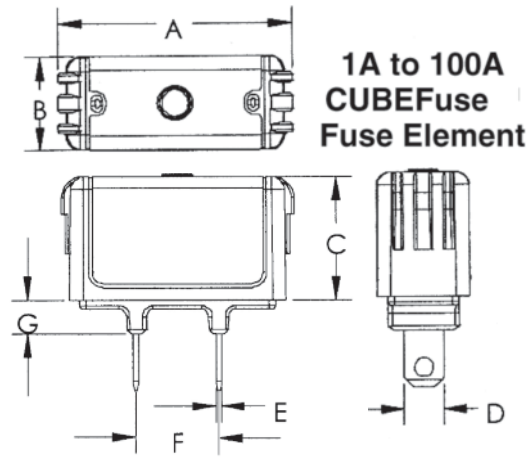

Fuse Amps	Dimensions - in (mm)						
	A	B	C	D	E	F	G
1-15	1.88 (47.75)	0.75 (19.05)	1.00 (25.40)	0.23 (5.84)	0.04 (1.02)	0.63 (15.93)	0.28 (7.11)
17 ½	1.88 (47.75)	0.75 (19.05)	1.00 (25.40)	0.31 (7.87)	0.04 (1.02)	0.63 (15.93)	0.28 (7.11)
20	1.88 (47.75)	0.75 (19.05)	1.00 (25.40)	0.31 (7.87)	0.04 (1.02)	0.63 (15.93)	0.28 (7.11)
25-30	1.88 (47.75)	0.75 (19.05)	1.00 (25.40)	0.31 (7.87)	0.04 (1.02)	0.63 (15.93)	0.28 (7.11)
35-40	2.13 (54.10)	1.00 (25.40)	1.13 (28.58)	0.36 (9.10)	0.04 (1.02)	0.63 (15.93)	0.38 (9.65)
45-50	2.13 (54.10)	1.00 (25.40)	1.13 (28.58)	0.44 (11.13)	0.04 (1.02)	0.63 (15.93)	0.38 (9.65)
60	2.13 (54.10)	1.00 (25.40)	1.13 (28.58)	0.44 (11.13)	0.04 (1.02)	0.63 (15.93)	0.38 (9.65)
70	3.01 (76.45)	1.00 (25.40)	1.26 (32.00)	0.49 (12.45)	0.06 (1.60)	0.58 (14.78)	0.38 (9.65)
80-90	3.01 (76.45)	1.00 (25.40)	1.26 (32.00)	0.49 (12.45)	0.06 (1.60)	0.58 (14.78)	0.38 (9.65)
100	3.01 (76.45)	1.00 (25.40)	1.26 (32.00)	0.57 (14.48)	0.06 (1.60)	0.58 (14.78)	0.38 (9.65)

Current Limitation Curves

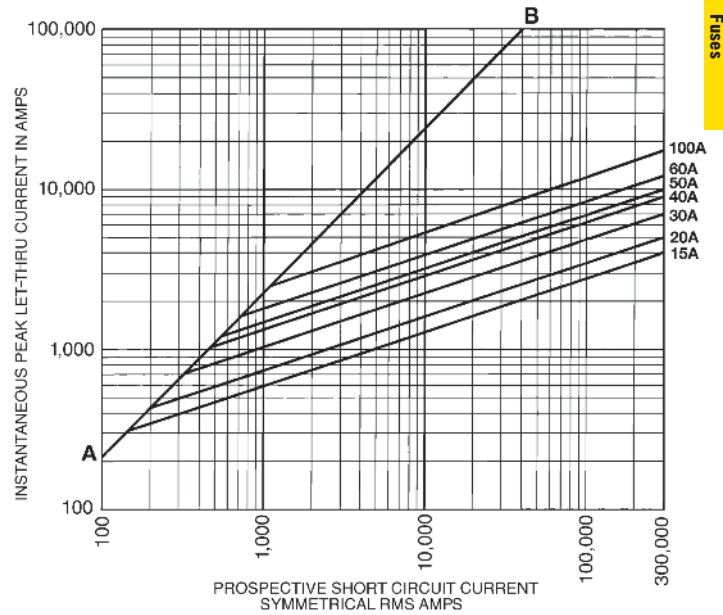

Low Voltage
Branch Circuit
Fuses

Time-Current Characteristic Curves—Average Melt

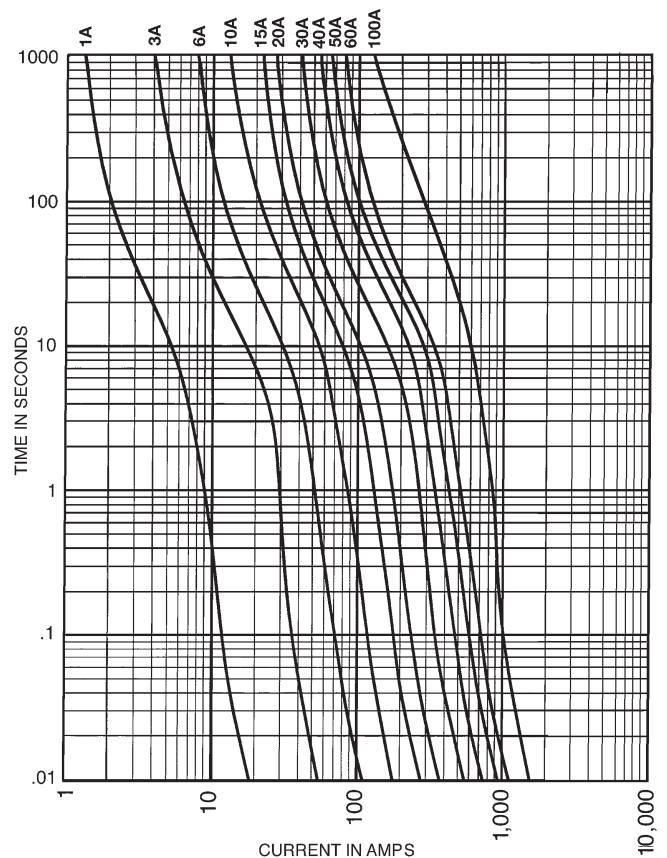

Data Sheet: 9000 (fuses) and 9007 (holders)

UPS & Critical Application Fast-Acting CUBEFuse™ Finger-safe Fuse

FCF Class CF Fuse



Catalog Symbol: FCF_RN

Fast-Acting Fuse: 4 minutes maximum clearing time at 200% rated current for 1 to 30A fuse
6 minutes maximum clearing time at 200% rated current for 35 to 60A fuse

Dimensions: See Dimensions illustration.

Poles: 1-pole (gangable)

Ratings:

- Volts — 600Vac (or less)
- 300Vdc (or less)
- Amps — 1-100A
- IR — 300kA RMS Sym. (UL)
- 200kA RMS Sym. (CSA)
- 50kA DC (UL & CSA)

Agency Information:

- UL Listed Fuse: Guide JFHR, File E4273
- CSA Certified Fuse: Class 1422- 02, File 53787
- CE compliance for the European Union low voltage directive

Other Ratings/Specifications:

Watts Loss at rated current: FCF15RN: 3.48W
FCF30RN: 5.45W
FCF60RN: 7.27W

Operating and Storage Temperature Range:

-40 to 80°C

Material Specifications:

- Case: Glass filled PES (Polyethersulfone)
- Terminals: Copper alloy
- Terminal plating: Electroless tin

Carton Quantity and Weight

Amp Rating	Carton Qty.	Weight Per Carton	
		lbs	kg
FCF-1-30A	12	1.39	0.63
FCF-35-60A	12	1.42	0.65
FCF-70-100A	6	1.74	0.79

Features and Product Benefits

- The world’s first finger-safe power fuse system.
- Smallest footprint of any class fuse including Class J, CC, T and RK.
- Class CF meets Class J fast-acting electrical performance requirements.
- Faster response to damaging faults to help reduce destructive thermal and magnetic forces.
- True fast-acting fuse construction.
- High interrupting rating to safely interrupt faults up to 300kA.
- No venting of arc or molten metal and gases during opening.
- Low let-through currents under fault conditions.

Fuse Catalog Numbers Non-Indicating (Amps)

FCF1RN	FCF20RN	FCF45RN	FCF90RN
FCF3RN	FCF25RN	FCF50RN	FCF100RN
FCF6RN	FCF30RN	FCF60RN	—
FCF10RN	FCF35RN	FCF70RN	—
FCF15RN	FCF40RN	FCF80RN	—



Scan this tag to get the latest product information for the New FCF CUBEFuse.

Recommended Fuse Holders For Class CF Fuses

- See pages 32 and 33

Data Sheet: 2147

UPS & Critical Application Fast-Acting CUBEFuse™ Finger-safe Fuse

FCF_RN Dimensions – in (mm)

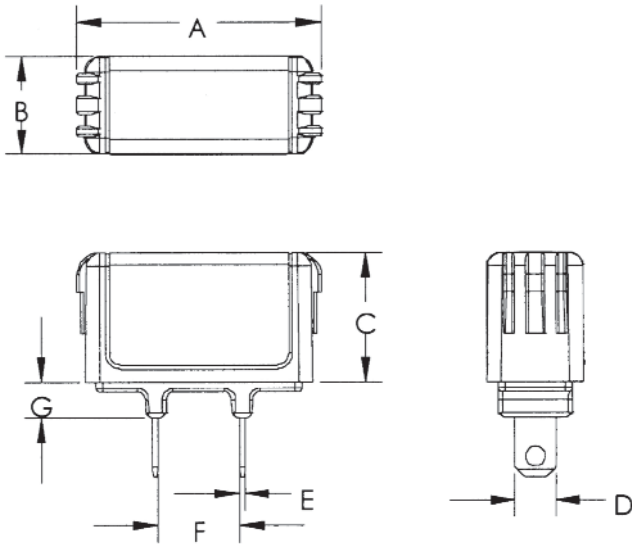

Fuse Amps	Dimensions - in (mm)						
	A	B	C	D	E	F	G
1-15	1.88 (47.75)	0.75 (19.05)	1.00 (25.40)	0.23 (5.84)	0.04 (1.02)	0.63 (15.93)	0.28 (7.11)
20	1.88 (47.75)	0.75 (19.05)	1.00 (25.40)	0.31 (7.87)	0.04 (1.02)	0.63 (15.93)	0.28 (7.11)
25-30	1.88 (47.75)	0.75 (19.05)	1.00 (25.40)	0.31 (7.87)	0.04 (1.02)	0.63 (15.93)	0.28 (7.11)
35-40	2.13 (54.10)	1.00 (25.40)	1.13 (28.58)	0.36 (9.10)	0.04 (1.02)	0.63 (15.93)	0.38 (9.65)
45-50	2.13 (54.10)	1.00 (25.40)	1.13 (28.58)	0.44 (11.13)	0.04 (1.02)	0.63 (15.93)	0.38 (9.65)
60	2.13 (54.10)	1.00 (25.40)	1.13 (28.58)	0.44 (11.13)	0.04 (1.02)	0.63 (15.93)	0.38 (9.65)
70	3.01 (76.45)	1.00 (25.40)	1.26 (32.00)	0.49 (12.45)	0.06 (1.60)	0.58 (14.78)	0.38 (9.65)
80-90	3.01 (76.45)	1.00 (25.40)	1.26 (32.00)	0.49 (12.45)	0.06 (1.60)	0.58 (14.78)	0.38 (9.65)
100	3.01 (76.45)	1.00 (25.40)	1.26 (32.00)	0.57 (14.48)	0.06 (1.60)	0.58 (14.78)	0.38 (9.65)

Current Limitation Curves

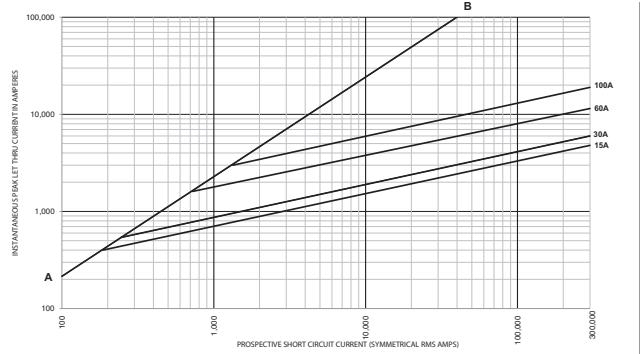

Time-Current Characteristic Curves—Average Melt

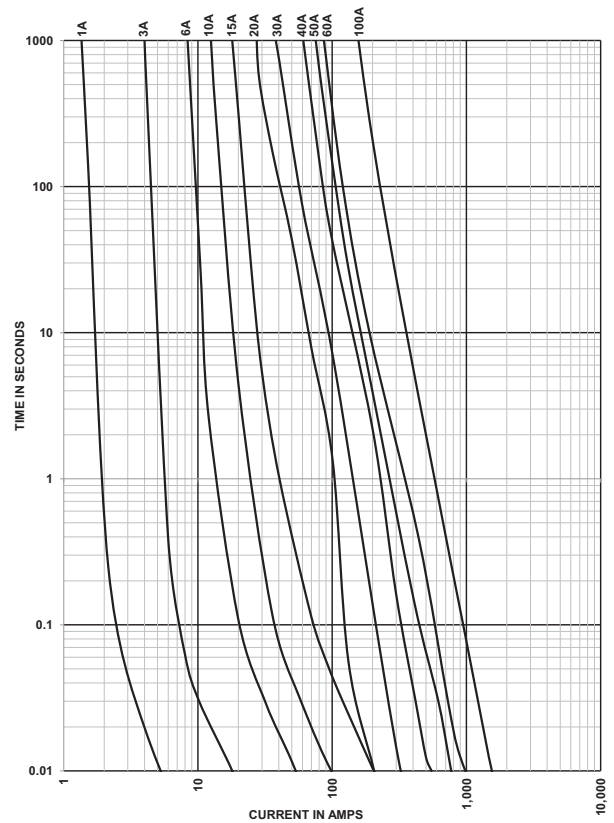

Wind Fast-Acting CUBEFuse™ – Finger-safe Fuse

WCF Class CF Fuse



Catalog Symbol: WCF_RN

Description: Finger-safe, fast-acting CUBEFuse for wind power generation.

Electrical Characteristics: Maximum clearing time at 200% rated current:

- 4 Minutes for 1 to 30A fuses
- 6 Minutes for 35 to 60A fuses
- 8 Minutes for 70 to 100A fuses

Ratings:

Volts — 690Vac

Amps — 1-100A

IR — 50kA AC (1-60A)

IR — 30kA AC (70-100A)

Agency Information:

- UL Recognized Fuse: Guide JFHR, File E56412
- cURus component certified C22.2
- CE compliance for the European Union low voltage directive

Other Ratings/Specifications:

Watts Loss at Rated Current: WCF15RN: 3.48W
 WCF30RN: 5.45W
 WCF60RN: 7.27W
 WCF100RN: 11.50W

Operating and Storage Temperature Range: -40 to 90°C

Material Specifications:

- Case: Glass filled PES (Polyethersulfone)
- Terminals: Copper alloy
- Terminal plating: Electroless tin

Installation:

Fits 690V WCF holders as listed in the table

Application:

- Wind Systems:
 - Transformer protection
 - Pitch and speed control
 - Turbine HVAC and lighting

Features and Product Benefits

- Maximize uptime and reliability using fuses designed and listed to UL 248-1.
- Minimize chances of equipment failure and personnel injury when using full range fuses having the industry's fastest response time to low-magnitude faults.
- Maximize return on investment with fuses proven to withstand harsh temperatures.
- Minimize design time, operating outage time and replacement cost with fuses qualified in excessively changing environmental conditions.
- Simplify compatibility with readily available industry standard Class CF holders.
- Temperature Derating: Designed to maximize rated capacity in elevated environmental temperatures.
- Overload Protection: Proven to clear faults faster than the UL requirement.
- Power Loss: Minimal energy consumption leading to increased efficiency.

Catalog Numbers (amp rating)

Non-Indicating Wind CUBEFuse				
WCF1RN	WCF15RN	WCF35RN	WCF60RN	WCF100RN
WCF3RN	WCF20RN	WCF40RN	WCF70RN	—
WCF6RN	WCF25RN	WCF45RN	WCF80RN	—
WCF10RN	WCF30RN	WCF50RN	WCF90RN	—

Carton Quantity and Weight

Amp Rating	Carton Qty.	Weight Per Carton	
		lbs	kg
WCF1-30A	12	1.39	0.63
WCF35-60A	12	1.42	0.65
WCF70-100A	6	1.74	0.79



Scan this tag to get the latest product information for the New WCF CUBEFuse.

Recommended Fuse Holders For Class CF Fuses

- See pages 32 and 33

Wind Fast-Acting CUBEFuse™ – Finger-safe Fuse

WCF_RN Dimensions – in (mm)

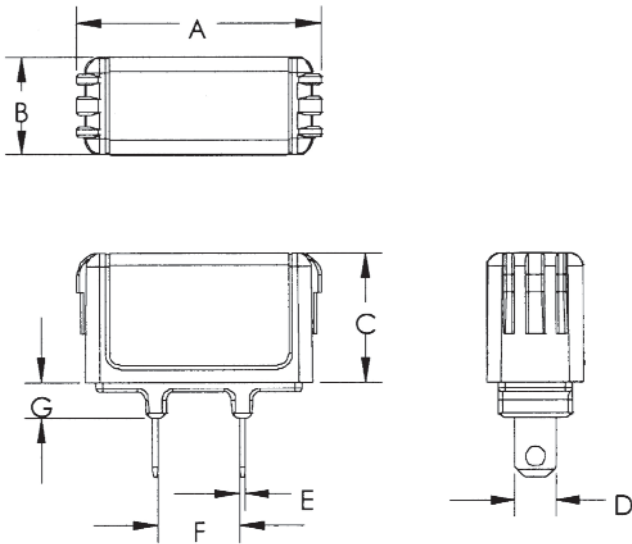

Fuse Amps	Dimensions - in (mm)						
	A	B	C	D	E	F	G
35-40	2.13 (54.10)	1.00 (25.40)	1.13 (28.58)	0.36 (9.10)	0.04 (1.02)	0.63 (15.93)	0.38 (9.65)
45-50	2.13 (54.10)	1.00 (25.40)	1.13 (28.58)	0.44 (11.13)	0.04 (1.02)	0.63 (15.93)	0.38 (9.65)
60	2.13 (54.10)	1.00 (25.40)	1.13 (28.58)	0.44 (11.13)	0.04 (1.02)	0.63 (15.93)	0.38 (9.65)
70	3.01 (76.45)	1.00 (25.40)	1.26 (32.00)	0.49 (12.45)	0.06 (1.60)	0.58 (14.78)	0.38 (9.65)
80-90	3.01 (76.45)	1.00 (25.40)	1.26 (32.00)	0.49 (12.45)	0.06 (1.60)	0.58 (14.78)	0.38 (9.65)
100	3.01 (76.45)	1.00 (25.40)	1.26 (32.00)	0.57 (14.48)	0.06 (1.60)	0.58 (14.78)	0.38 (9.65)

Current Limitation Curves

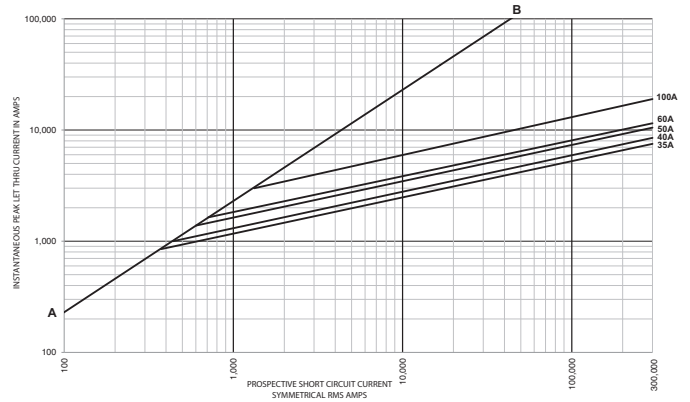

Time-Current Characteristic Curves—Average Melt

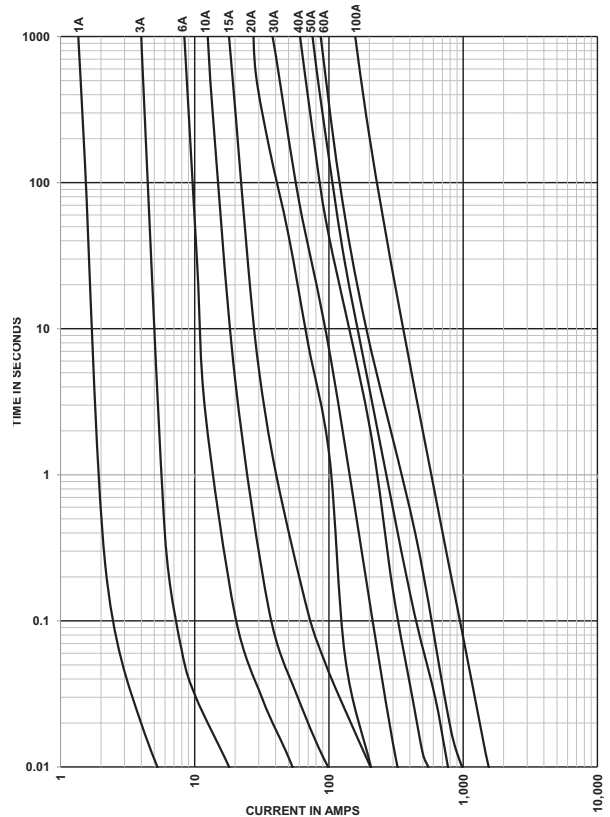

Low Voltage
Branch Circuit
Fuses

CUBEFuse™ Finger-safe Fuse Holder System

CUBEFuse Fuse Holder

Catalog Symbols:

		Ampacity (holds any CUBEFuse)
600V	690V (Wind)	
TCFH30N	TCFH30NW	(1-30A)
TCFH60N	TCFH60NW	(1-60A)
TCFH100N	TCFH100NW	(1-100A)

Construction: Finger-safe

Mounting: 35mm DIN-Rail or panel mount

Ratings:

Volts: 600V (UL, CSA)
690V (cURus - Wind version)

Withstand Rating: 300kA RMS Sym. (UL)
200kA RMS Sym. (CSA)
100kA DC (UL & CSA)
50kA AC (cURus, 1-60A Wind version)

Agency Information:

- UL Listed Fuse Holder: Guide IZLT, File E14853
- CSA Certified Fuse Holder: Class 6225-01, File 47235
- cURus component Certified
- CE compliance for the European Union low voltage directive



Operating and Storage Temperature Range:
-40 to 80°C

Material Specifications:

- Holder case: Glass filled PBT
- Interface clips: Copper alloy
- Interface clip plating: Tin
- Terminals: Steel
- DIN Rail spring: Stainless steel

CUBEFuse™ Holder Applications

CUBEFuse Holder Catalog Number	Volts	CUBEFuse Type and Ampacity Range Per CUBEFuse Holder				
		Non-Indicating Time-Delay TCF_RN	Indicating Time-Delay TCF_	Fast-Acting FCF_RN	Photovoltaic PVCF_RN	Wind WCF_RN
TCFH30N	600	1-30	6-30	1-30	—	—
TCFH60N	600	1-60	6-60	1-60	35-60	—
TCFH100N	600	1-100	6-100	1-100	35-100	—
TCFH30NW	690	—	—	—	—	1-30
TCFH60NW	690	—	—	—	—	1-60
TCFH100NW	690	—	—	—	—	1-100

Terminal Torque Ratings by Conductor and Holder Size (75°C Cu only)

TCFH30N / TCFH30NW		TCFH60N / TCFH60NW		TCFH100N / TCFH100NW	
Single	Dual	Single	Dual	Single	Dual
10-8AWG 25Lb-In	18-10AWG 25Lb-In*	14-10AWG 20Lb-In	18-10AWG 20Lb-In	18-10AWG 25Lb-In**	6AWG 45Lb-In†
18-12AWG 20Lb-In		8-4AWG 35Lb-In	8-6AWG 35Lb-In	8-1AWG 40Lb-In†	

* 18-10AWG Stranded, 14-18AWG solid

** Solid and stranded

† Stranded

Data Sheet: 9007

CUBEFuse™ Finger-safe Fuse Holder System

Low Voltage
Branch Circuit
Fuses

Dimensions for CUBEFuse Fuse Holder

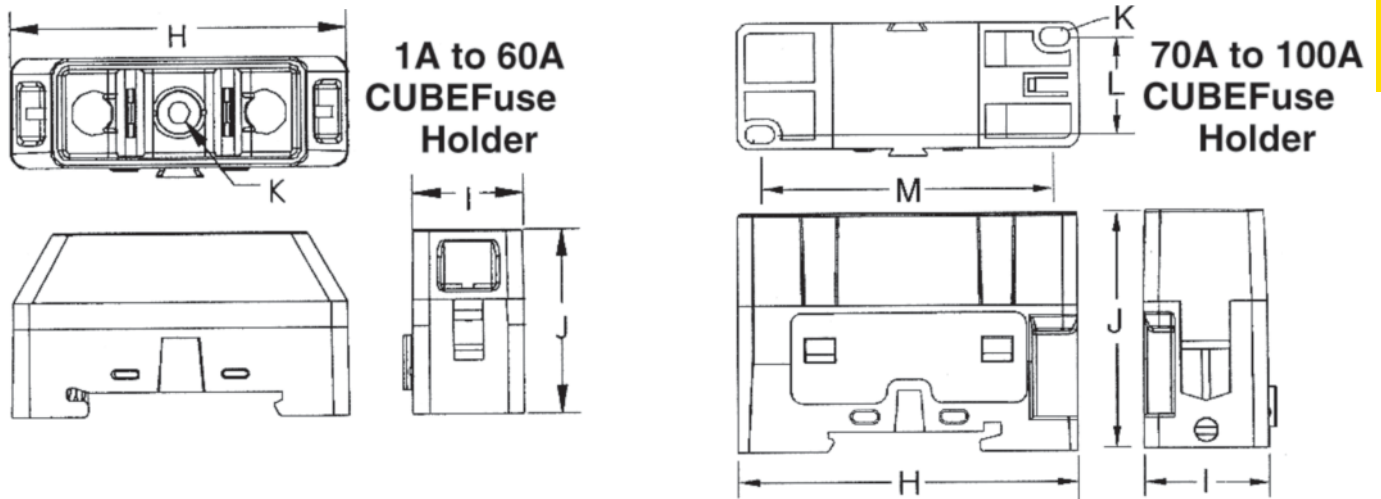

CUBEFuse™ Holder Catalog Numbers

Catalog Number	CUBEFuse Amp Range	Wire Range (Cu/AWG)		Dimensions - in (mm)					
		Single	Dual	H	I	J	K	L	M
TCFH30N TCFH30NW	1-30	14-8	14-10	2.30 (58.5)	0.76 (19.37)	1.36 (34.24)	0.15 (3.76)	—	—
TCFH60N TCFH60NW	1-60	14-4	10-6	2.60 (66.12)	1.03 (26.23)	1.60 (40.64)	0.17 (4.34)	—	—
TCFH100N TCFH100NW	1-100	10-1	6	2.91 (73.81)	1.05 (26.74)	2.01 (50.93)	0.15 (3.81)	0.80 (20.39)	2.51 (63.65)

Time-delay Fuses

SC Class G

Specifications

Description: Fast-acting ($\frac{1}{2}$ -6A), time-delay (7-60A) fuse.

Dimensions: See dimensions illustration.

Ratings:

- Volts — 600Vac ($\frac{1}{2}$ -20A)
 — 480Vac (25-60A)
 — 170Vdc ($\frac{1}{2}$ -20A)
 — 300Vdc (30 & 60A only)
- Amps — $\frac{1}{2}$ -60A
 IR — 100kA RMS Sym.
 — 10kA DC

Agency Information: CE, Std. 248-5, Class G, UL Listed, Guide JDDZ, File E4273, CSA Certified, Class 1422-01, File 53787.

Features and Benefits

- Current limiting for component protection, providing Class G energy-limitation for branch circuit protection.
- 100kA interrupting rating provides cost-effective branch circuit fusing.
- Variations in length help prevent overfusing.

Typical Applications

- Fusible Branch Panelboards
- HVAC Branch Circuit Protection

Catalog Numbers (Amps)

SC- $\frac{1}{2}$	SC-2- $\frac{1}{2}$	SC-6	SC-12	SC-30	SC-50
SC-1	SC-3	SC-7	SC-15	SC-35	SC-60
SC-1- $\frac{1}{2}$	SC-4	SC-8	SC-20	SC-40	
SC-2	SC-5	SC-10	SC-25	SC-45	

Dimensions -in (mm)

Fuse Amps	Length	Diameter
SC- $\frac{1}{2}$ to -15	1.31 (33.3)	0.41" (10.4)
SC-20	1.41 (35.8)	0.41" (10.4)
SC-25 to -30	1.62 (41.2)	0.41" (10.4)
SC-35 to -60	2.25 (57.1)	0.41" (10.4)

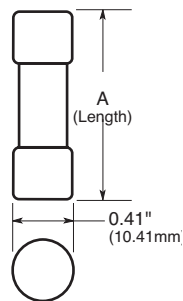

Time-Current Characteristic Curves—Average Melt

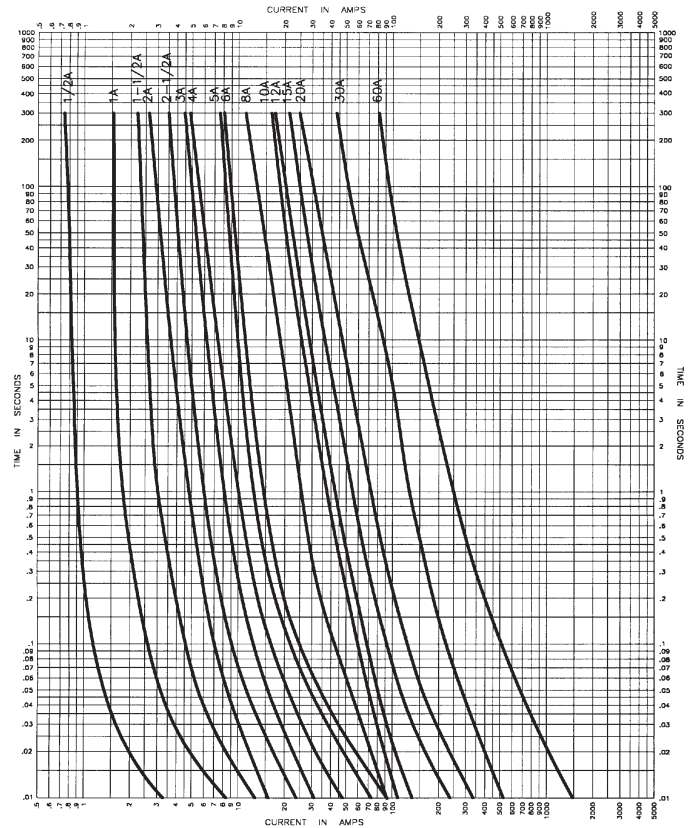

Current Limitation Curves

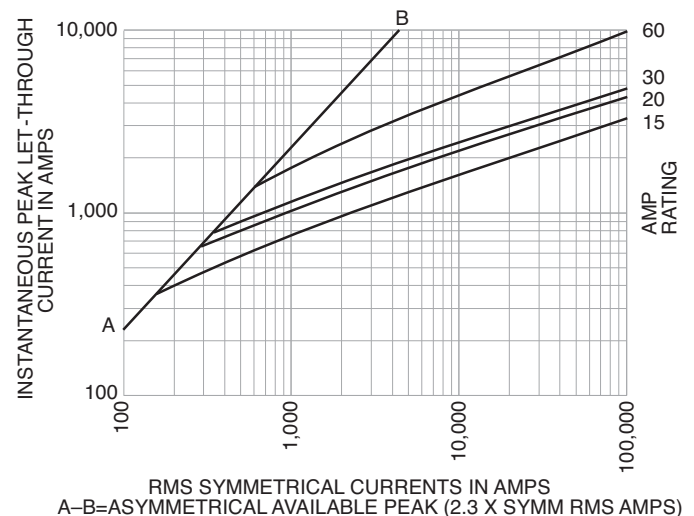

Recommended Fuse Holders & Blocks For Class G Fuses

- See page 18

Low-Peak™ Dual-element, Time-delay Fuses

LPJ_SP Class J

Available With
Indication



Specifications

Description:

Dual-element, time-delay fuse; 10 seconds (minimum) at 500% rated amps. Now available with optional indication on select ratings (see Catalog Numbers table).

Dimensions: See page 11 for Class J dimensions.

Ratings:

- Volts — 600Vac (or less)
- 300Vdc (or less)
- Amps — 1-600A
- IR — 300kA RMS Sym.
- 100kA DC

Agency Information: CE, UL Listed - Special Purpose*, Guide JFHR, File E56412, CSA Certified (200k AIR) Class J per CSA-22.2 No. 248.8, Class 1422-02, File 53787.

Features and Benefits

- Separate overload and short-circuit elements provide time delay for sizing of high inrush loads linked with Class J current limitation.
- Selective coordination ratio of 2:1 (within Low-Peak fuse family) prevents electrical shutdowns from extending beyond the failed circuit.
- Series combination ratings with branch circuit breakers allows broad range of coverage, independent of breaker manufacturer.

Typical Applications

- Power Panelboards
- Branch Circuit Breaker Panelboard Mains
- Machinery Disconnects
- Industrial Control

Catalog Numbers (Amps)

LPJ-1SP	LPJ-4-½SP	LPJ-25SP**	LPJ-125SP**
LPJ-1-¼SP	LPJ-5SP	LPJ-30SP**	LPJ-150SP**
LPJ-1-⅝SP	LPJ-5-⅝SP	LPJ-35SP**	LPJ-175SP**
LPJ-1-⅞SP	LPJ-6SP**	LPJ-40SP**	LPJ-200SP**
LPJ-2SP	LPJ-7SP**	LPJ-45SP**	LPJ-225SP**
LPJ-2-¼SP	LPJ-8SP**	LPJ-50SP**	LPJ-250SP**
LPJ-2-½SP	LPJ-9SP**	LPJ-60SP**	LPJ-300SP**
LPJ-2-⅝SP	LPJ-10SP**	LPJ-70SP**	LPJ-350SP**
LPJ-3SP	LPJ-12SP**	LPJ-80SP**	LPJ-400SP**
LPJ-3-⅝SP	LPJ-15SP**	LPJ-90SP**	LPJ-450SP**
LPJ-3-¾SP	LPJ-17-½SP**	LPJ-100SP**	LPJ-500SP**
LPJ-4SP	LPJ-20SP**	LPJ-110SP**	LPJ-600SP**

*Meets all performance requirements of UL Standard 248-8 for Class J fuses.

**Available with optional permanent replace fuse indication. To order, place "I" at end of catalog number. Example: LPJ-6SPI.

Available with silver plated terminals. Add SP/ in front of Catalog Number.

Data Sheets: 1006 (0-60) and 1007 (70-600)
With indication **1062 (6-60) and 1063 (70-600)**

Time-Current Characteristic Curves—Average Melt

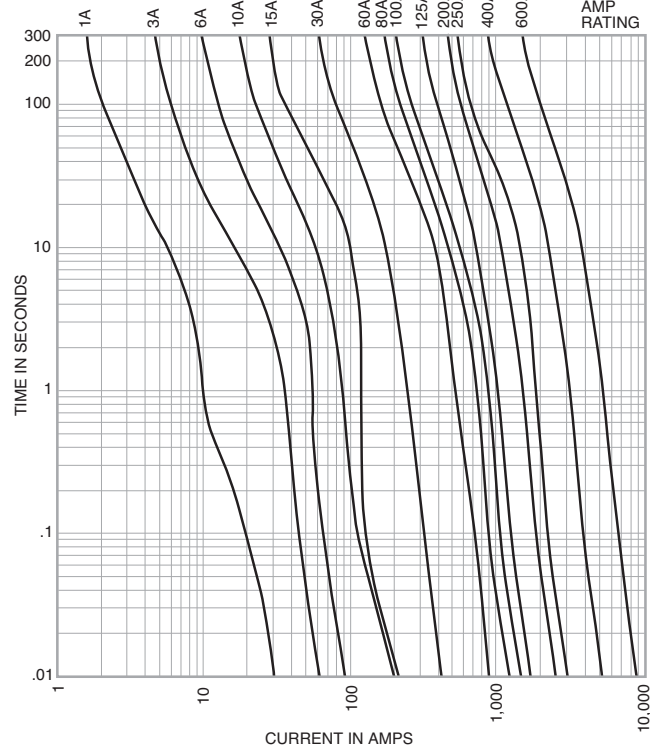

Current Limitation Curves

LPJ Current Limitation Curves

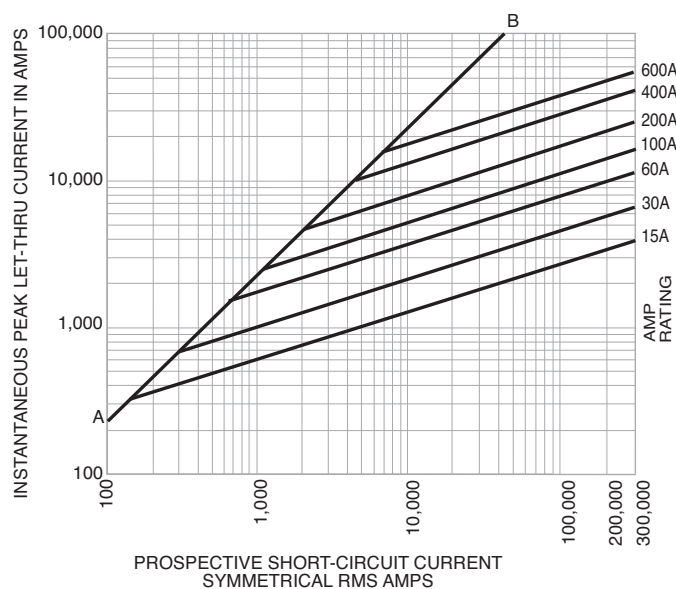

Low Voltage
Branch Circuit
Fuses

Recommended Fuse Holders & Blocks For Class J Fuses
• See page 20

Limitron™ Fast-acting Fuses

JKS Class J

Specifications

Description: Fast-acting, current-limiting fuse.

Dimensions: See page 15 for Class J dimensions.

Ratings:

Volts — 600Vac (or less)

Amps — 1-600A

IR — 200kA RMS Sym.

Agency Information:

CE, Std.
248-8, Class J, UL
Listed, Guide JDDZ,
File E4273, CSA
Certified, Class 1422-02, File 53787.



Time-Current Characteristic Curves—Average Melt

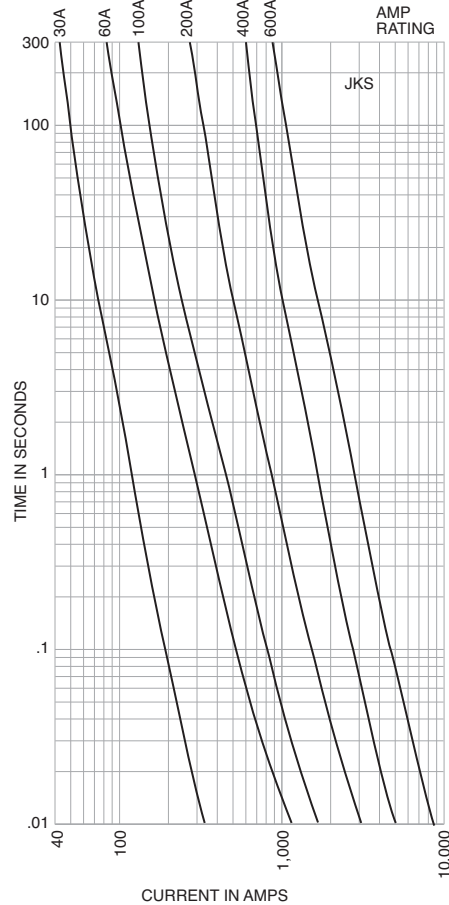

Features and Benefits

- Current limitation for non-inductive circuits provides Class J current-limiting response to maximum ground fault and short-circuit conditions.
- 200kA interrupting rating provides high ratings at all circuit locations.
- Economical solutions for high-fault circuits.

Typical Applications

- Power Panelboards
- Machinery Disconnects

Catalog Numbers (Amps)

JKS-1	JKS-15	JKS-70	JKS-225
JKS-2	JKS-20	JKS-80	JKS-250
JKS-3	JKS-25	JKS-90	JKS-300
JKS-4	JKS-30	JKS-100	JKS-350
JKS-5	JKS-35	JKS-110	JKS-400
JKS-6	JKS-40	JKS-125	JKS-450
JKS-8	JKS-45	JKS-150	JKS-500
JKS-10	JKS-50	JKS-175	JKS-600
JKS-12	JKS-60	JKS-200	

Current Limitation Curves

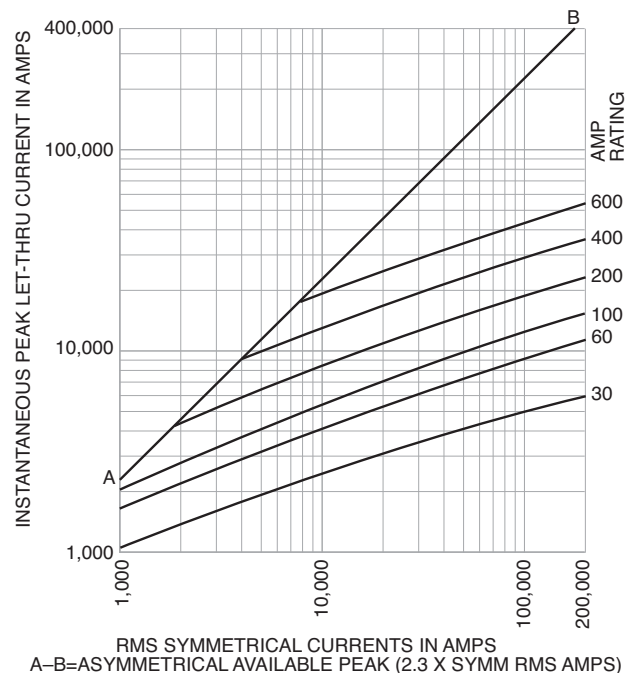

For superior electrical protection, Bussmann recommends upgrading JKS fuse applications to Low-Peak LPJ fuses See page 35.

Recommended Fuse Holders & Blocks For Class J Fuses

- See page 20

Data Sheet: 1026 (1-60) and 1027 (70-600)

One-time General Purpose Fuses

NON (250Vac/125Vdc) Class K5 & H

NOS (600Vac) Class K5 & H

Specifications

Description: General purpose, non-current-limiting fuses.

Dimensions: See page 15 for dimensions.

Ratings:

- Volts — **NON:**
- 250Vac
 - 125Vdc (0-100A)
- **NOS:**
- 600Vac
- Amps — 1/8-600A
- IR — 50kA RMS Sym. (NON & NOS Class K5 0-60A)
- 10kA RMS Sym. (NON & NOS Class H65-600A)
 - 50kA @ 125Vdc (NON Class K5 0-60A)
 - 10kA @ 125Vdc (NON Class H 65-100A)



Agency Information: CE, UL Listed – 250V: Class K5 (0-60A), Std. 248-9, Class H (65-600A), Std. 248-6, (125Vdc: NON 0-100), 600V: Class K5 (0-60A), Std. 248-9, Class H (70-600A), Std. 248-6, Guide JDDZ, File E4273, CSA Certified – 250V: (0-12, 65-600)†, 600V: (0-600), Class 1421-01, File 53787.

† For CSA Certified 15-60A Ratings, see PON Data Sheet 4126

Features and Benefits

- Original fuse providing circuit protection.

Typical Applications

- Light Duty Circuit Locations

NON (250Vac) Catalog Numbers (Amps)

NON-1/8	NON-5	NON-40	NON-175
NON-1/4	NON-6	NON-45	NON-200
NON-3/8	NON-6-1/4	NON-50	NON-225
NON-1/2	NON-7	NON-60	NON-250
NON-1	NON-8	NON-65	NON-300
NON-1-1/4	NON-9	NON-70	NON-350
NON-1-1/2	NON-10	NON-75	NON-400
NON-1-3/4	NON-12	NON-80	NON-450
NON-2	NON-15	NON-90	NON-500
NON-2-1/2	NON-20	NON-100	NON-600
NON-3	NON-25	NON-110	
NON-3-3/4	NON-30	NON-125	
NON-4	NON-35	NON-150	

NOS (600Vac) Catalog Numbers (Amps)

NOS-1	NOS-12	NOS-70	NOS-200
NOS-2	NOS-15	NOS-75	NOS-225
NOS-3	NOS-20	NOS-80	NOS-250
NOS-4	NOS-25	NOS-90	NOS-300
NOS-5	NOS-30	NOS-100	NOS-350
NOS-6	NOS-35	NOS-110	NOS-400
NOS-7	NOS-40	NOS-125	NOS-450
NOS-8	NOS-45	NOS-150	NOS-500
NOS-9	NOS-50	NOS-175	NOS-600
NOS-10	NOS-60		

Recommended Fuse Reducers

250V Fuse Amp Size	Clip Amp Size	Catalog Number (Pair)	600V Fuse Amp Size	Clip Amp Size	Catalog Number (Pair)
30	60	NO.263	30	60	NO.663
30	100	NO.213	30	100	NO.216
60	100	NO.216	60	100	NO.616
60	200	NO.226	60	200	NO.626
100	200	NO.2621	100	200	NO.2621
100	400	NO.2641	100	400	NO.2641
200	400	NO.2642	200	400	NO.2642
100	600	NO.2661	100	600	NO.2661
200	600	NO.2662	200	600	NO.2662
400	600	NO.2664	400	600	NO.2664

For superior electrical protection, Bussmann recommends upgrading NON (250Vac) and NOS (600Vac) fuse applications to Low-Peak LPN-RK (250Vac) and LPS-RK (600Vac) fuses See page 41.

Recommended Fuse Holders & Blocks For Class K5 & H 250V & 600V Fuses

- See page 18

Data Sheet: 1030

Low-Peak™ Time-delay Fuses

KRP-C_SP Class L

Specifications

Description: Time-delay fuse – 4 seconds (minimum) at 500% rated amps.

Dimensions: See page 16 for Class L dimensions.

Ratings:

- Volts — 600Vac (or less)
- 300Vdc (601-2000A)
- Amps — 601-6000A
- (use KRP-CL for current ratings under 601A)
- IR — 300kA RMS Sym.
- 100kA DC



Catalog Numbers (Amps)

KRP-C-601SP	KRP-C-1000SP	KRP-C-1800SP	KRP-C-3500SP
KRP-C-650SP	KRP-C-1100SP	KRP-C-1900SP	KRP-C-4000SP
KRP-C-700SP	KRP-C-1200SP	KRP-C-2000SP	KRP-C-4500SP
KRP-C-750SP	KRP-C-1350SP	KRP-C-2001SP	KRP-C-5000SP
KRP-C-800SP	KRP-C-1400SP	KRP-C-2400SP	KRP-C-6000SP
KRP-C-801SP	KRP-C-1500SP	KRP-C-2500SP	
KRP-C-900SP	KRP-C-1600SP	KRP-C-3000SP	

Agency Information: CE, UL Listed-Special Purpose (meets all performance requirements of UL Standard 248-10 for Class L fuses), Guide JFHR, File E56412, CSA Certified (200k AIR), Class 1422-02, File 53787, Class L per CSA C22.2, No. 248.10.

Features and Benefits

- Time-delay of four seconds at five times rating allows closer sizing on large motor loads combined with Class L current limitation.
- Selective coordination ratio of 2:1 (within Low-Peak fuse family) prevents electrical shutdowns from extending beyond the failed circuit.
- Interrupting rating of 300kA RMS symmetrical provides adequate ratings without obsolescence for all electrical systems, big or small.
- Quality construction, using high-grade materials, provides lower watts loss and operating temperatures with superior arc quenching during current-limiting action.

Typical Applications

- Large Distribution Switchboards
- Power Panelboards
- Large Machinery Disconnects

Recommended Fuse Holders & Blocks For Class L Fuses

- See page 19

Data Sheets: 1008 and 1009

Low-Peak™ Time-delay Fuses

Time-Current Characteristic Curves—Average Melt

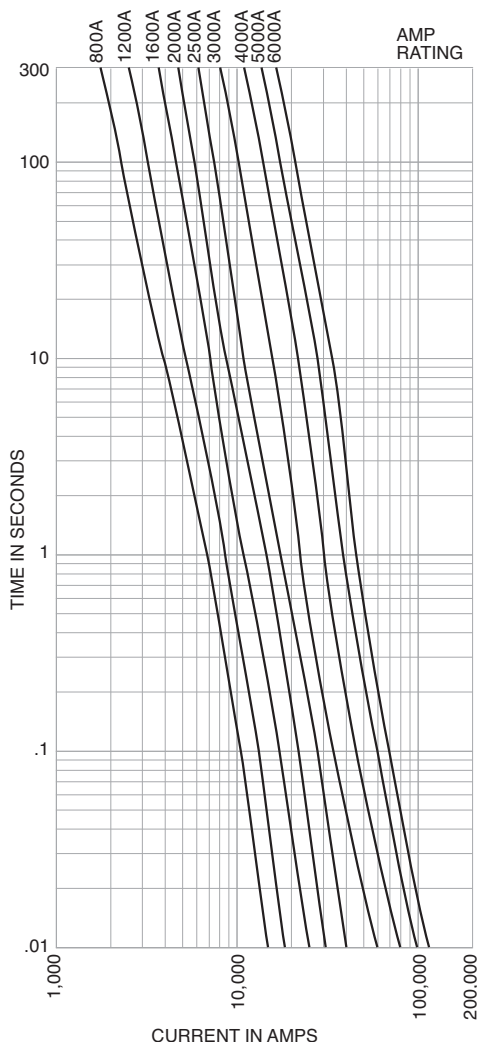

Current Limitation Curves

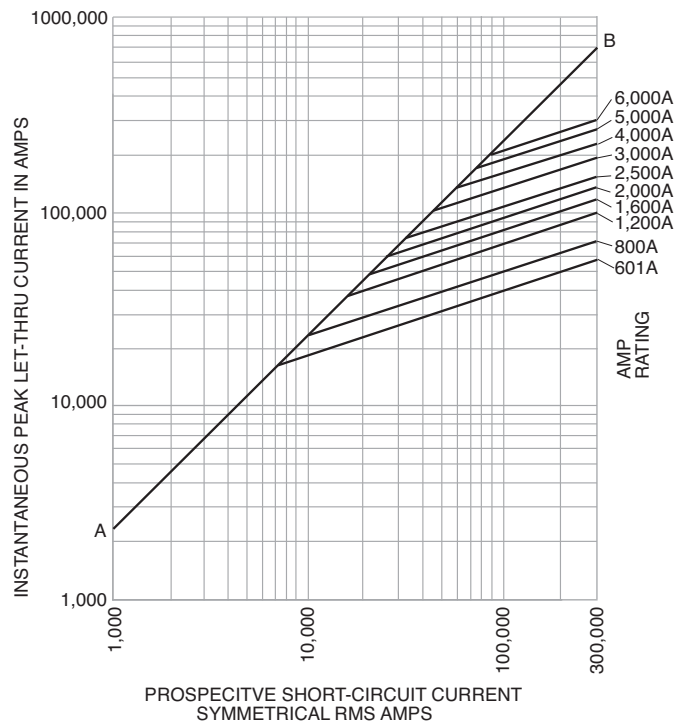

Low Voltage
Branch Circuit
Fuses

Data Sheets: 1008 and 1009

KRP-CL Current-limiting, Time-delay Fuses

Specifications

Description: Current-limiting, time-delay fuse.

Dimensions: See page 16 for Class L dimensions.

Ratings:

Volts — 600Vac (or less)

Amps — 225-600A

IR — 200kA RMS Sym.

Features and Benefits

- Time-delay of four seconds at five times rating allows closer sizing inductive loads coupled with an equivalent Class L current limitation.

- Class L case size for amp ratings from 225 to 600A allows downsize fusing of large Class L fused switches for improved circuit protection.

Typical Applications

- Large Distribution Switchboards
- Power Panelboards
- Machinery Disconnects

Catalog Numbers (Amps)

KRP-CL-225	KRP-CL-350	KRP-CL-500
KRP-CL-250	KRP-CL-400	KRP-CL-600
KRP-CL-300	KRP-CL-450	

Recommended Fuse Holders & Blocks For Class L Fuses

- See page 19

Data Sheet: 1016

Limitron™ Fuses

KTU Class L

Specifications

Description: Fast-acting, bolt-mount fuse.

Dimensions: See page 22 for Class L dimensions.

Ratings:

- Volts — 600Vac (or less)
- Amps — 601-6000A
- IR — 200kA RMS Sym.

Agency Information: CE, Std. 248-10, Class L, UL Listed, Guide JDDZ, File E4273 CSA Certified, Class 1422-02, File 53787.

Features and Benefits

- 200kA interrupting rating provides high ratings at all circuit locations.
- Economical solutions for high-fault circuits.
- Quality construction using high-grade materials provides lower watts loss and operating temperatures with superior arc quenching during current-limiting action.

Typical Applications

- Large Distribution Switchboards
- Power Panelboards

Catalog Number (Amps)

KTU-601	KTU-1000	KTU-2001
KTU-650	KTU-1100	KTU-2400
KTU-700	KTU-1200	KTU-2500
KTU-750	KTU-1400	KTU-3000
KTU-800	KTU-1500	KTU-3500
KTU-801	KTU-1600	KTU-4000
KTU-850	KTU-1800	KTU-5000
KTU-900	KTU-2000	KTU-6000



KLU Class L

Specifications

Description: Time-delay, bolt-mount fuse - 5 seconds (minimum) at 500% rated amps. See KRP-CL for amp ratings below 601A.

Dimensions: See page 22 for Class L dimensions.

Ratings:

- Volts — 600Vac (or less)
- Amps — 601-4000A
- IR — 200kA RMS Sym.

Agency Information: CE, Std. 248-10, Class L, UL Listed, Guide JDDZ, File E4273, CSA Certified, CSA Class 1422-02, File 53787.

Features and Benefits

- 200kA interrupting rating provides high ratings at all circuit locations.
- Economical solutions for high fault circuits.

Typical Applications

- Large Distribution Switchboards
- Power Panelboards
- Large Machinery Disconnects

Catalog Numbers (Amps)

KLU-601	KLU-1200	KLU-2500
KLU-650	KLU-1500	KLU-3000
KLU-700	KLU-1600	KLU-4000
KLU-800	KLU-1800	
KLU-1000	KLU-2000	



For superior electrical protection, Cooper Bussmann recommends upgrading KTU fuse applications to Low-Peak KRP-C fuses See page 38.

Recommended Fuse Holders & Blocks For Class L Fuses

- See page 19

For superior electrical protection, Cooper Bussmann recommends upgrading KLU fuse applications to Low-Peak KRP-C fuses See page 38.

Recommended Fuse Holders & Blocks For Class L Fuses

- See page 19

Low-Peak™ Dual-element, Time-delay Fuses

LPN-RK_SP (250V) Class RK1

LPS-RK_SP (600V) Class RK1

Available With
Indication



Specifications

Description:

Current-limiting, dual-element, time-delay fuse; 10 seconds (minimum) at 500% rated amps (8 seconds for 0-30A sizes). Now available with optional indication on select ratings (see Catalog Numbers table).

Dimensions: See page 15 for Class RK1 dimensions.

Ratings:

Volts **LPN-RK:**

- 250Vac (or less)
- 125Vdc (0-60A)
- 250Vdc (70-600A)

LPS-RK:

- 600Vac (or less)
- 300Vdc

Amps — 1/10-600A

- IR — 300kA RMS Sym.
- 100kA DC

Agency Information: CE, UL Listed – Special Purpose*, Guide JFHR, File E56412, CSA Certified (200k AIR), Class RK1 per CSA C22.2, No. 248.12, Class 1422-02, File 53787.

Features and Benefits

- Separate overload and short-circuit elements provide time delay for close sizing of high inrush loads linked with RK1 current-limitation and selective coordination ratio of 2:1 (within Low-Peak fuse family) prevents widespread blackouts.
- Inventory consolidation of Class RK1, RK5 and H fuses for reduced SKU investment and minimizing potential for misapplying fuse.
- 300kA RMS symmetrical interrupting rating provides adequate ratings without obsolescence for all electrical systems, big or small.
- Insulated end caps reduces exposure to live parts and extends air gap to distance between blades of adjacent mounted fuses or to housing.

Data Sheets: LPN-RK — 1003 (0-60) and 1004 (70-600)
 LPN-RK with indication — 1066 (70-600)
 LPS-RK — 1001 (0-60) and 1002 (70-600)
 LPS-RK with indication — 1061 (0-60) and 1064 (70-600)

Typical Applications

- Large Distribution Switchboards
- Power Panelboards
- Motor Control Centers
- Machinery Disconnect Switches

LPN Catalog Numbers (Amps)

LPN-RK-1/10SP	LPN-RK-3-1/2SP	LPN-RK-60SP**
LPN-RK-1/100SP	LPN-RK-4SP	LPN-RK-70SP**
LPN-RK-1/2SP	LPN-RK-4-1/2SP	LPN-RK-80SP**
LPN-RK-1/20SP	LPN-RK-5SP	LPN-RK-90SP**
LPN-RK-1/25SP	LPN-RK-5-1/2SP	LPN-RK-100SP**
LPN-RK-1/30SP	LPN-RK-6SP	LPN-RK-110SP**
LPN-RK-1/40SP	LPN-RK-6-1/2SP	LPN-RK-125SP**
LPN-RK-1/50SP	LPN-RK-8SP	LPN-RK-150SP**
LPN-RK-1SP	LPN-RK-9SP	LPN-RK-175SP**
LPN-RK-1-1/2SP	LPN-RK-10SP	LPN-RK-200SP**
LPN-RK-1-1/4SP	LPN-RK-12SP	LPN-RK-225SP**
LPN-RK-1-1/8SP	LPN-RK-15SP	LPN-RK-250SP**
LPN-RK-1-1/20SP	LPN-RK-17-1/2SP	LPN-RK-300SP**
LPN-RK-1-1/30SP	LPN-RK-20SP	LPN-RK-350SP**
LPN-RK-2SP	LPN-RK-25SP	LPN-RK-400SP**
LPN-RK-2-1/2SP	LPN-RK-30SP	LPN-RK-450SP**
LPN-RK-2-1/4SP	LPN-RK-35SP**	LPN-RK-500SP**
LPN-RK-2-1/10SP	LPN-RK-40SP**	LPN-RK-600SP**
LPN-RK-3SP	LPN-RK-45SP**	
LPN-RK-3-1/2SP	LPN-RK-50SP**	

*Meets all performance requirements of UL Standard 248-12 for Class RK1 fuses.
 **Available with optional indication. To order, place "I" at end of Catalog Number. Example: LPN-RK-35SP-I.
 0-60A fuses available with Nickel plate option. (Ex: LPS-RK30SPNP) 70-600A fuses available with Tin plate option. Example: LPS-RK-100SP-TP.

LPS Catalog Numbers - (Amps)

LPS-RK-1/10SP	LPS-RK-2-1/2SP	LPS-RK-10SP**	LPS-RK-100SP**
LPS-RK-1/20SP	LPS-RK-2-1/4SP	LPS-RK-12SP**	LPS-RK-110SP**
LPS-RK-1/30SP	LPS-RK-2-1/10SP	LPS-RK-15SP**	LPS-RK-125SP**
LPS-RK-1/40SP	LPS-RK-3SP	LPS-RK-17-1/2SP**	LPS-RK-150SP**
LPS-RK-1/50SP	LPS-RK-3-1/2SP	LPS-RK-20SP**	LPS-RK-175SP**
LPS-RK-1/60SP	LPS-RK-3-1/4SP	LPS-RK-25SP**	LPS-RK-200SP**
LPS-RK-1/75SP	LPS-RK-4SP	LPS-RK-30SP**	LPS-RK-225SP**
LPS-RK-1SP	LPS-RK-4-1/2SP	LPS-RK-35SP**	LPS-RK-250SP**
LPS-RK-1-1/2SP	LPS-RK-5SP	LPS-RK-40SP**	LPS-RK-300SP**
LPS-RK-1-1/4SP	LPS-RK-5-1/2SP	LPS-RK-45SP**	LPS-RK-350SP**
LPS-RK-1-1/8SP	LPS-RK-6SP**	LPS-RK-50SP**	LPS-RK-400SP**
LPS-RK-1-1/20SP	LPS-RK-6-1/2SP**	LPS-RK-60SP**	LPS-RK-450SP**
LPS-RK-1-1/30SP	LPS-RK-7SP**	LPS-RK-70SP**	LPS-RK-500SP**
LPS-RK-1-1/40SP	LPS-RK-8SP**	LPS-RK-80SP**	LPS-RK-600SP**
LPS-RK-2SP	LPS-RK-9SP**	LPS-RK-90SP**	

*Meets all performance requirements of UL Standard 248-12 for Class RK1 fuses.
 **Available with optional replace fuse indication. To order, place "I" at end of Catalog Number. Example: LPS-RK-15SP-I.

Recommended Fuse Holders & Blocks For Class RK1 Fuses

- See page 19

Low-Peak™ Dual-element, Time-delay Fuses

Time-Current Characteristic Curves—Average Melt

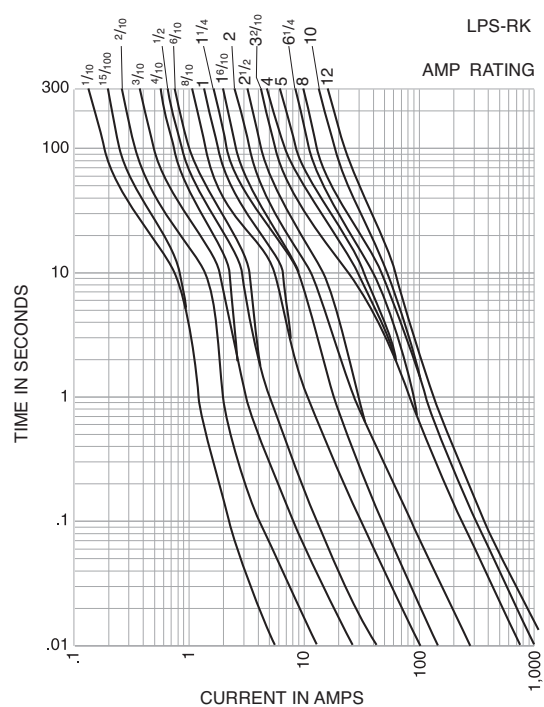
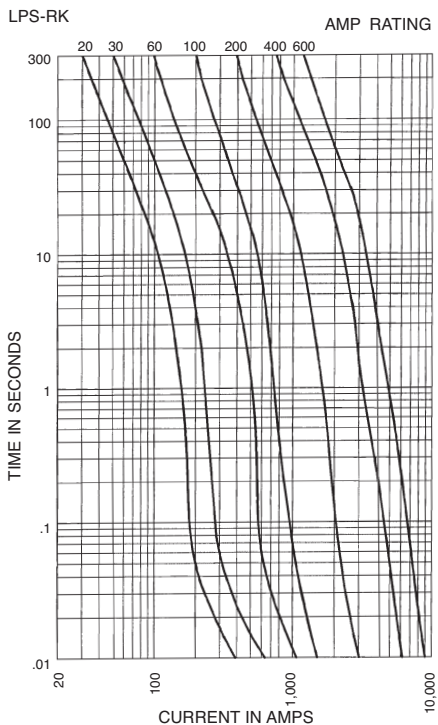
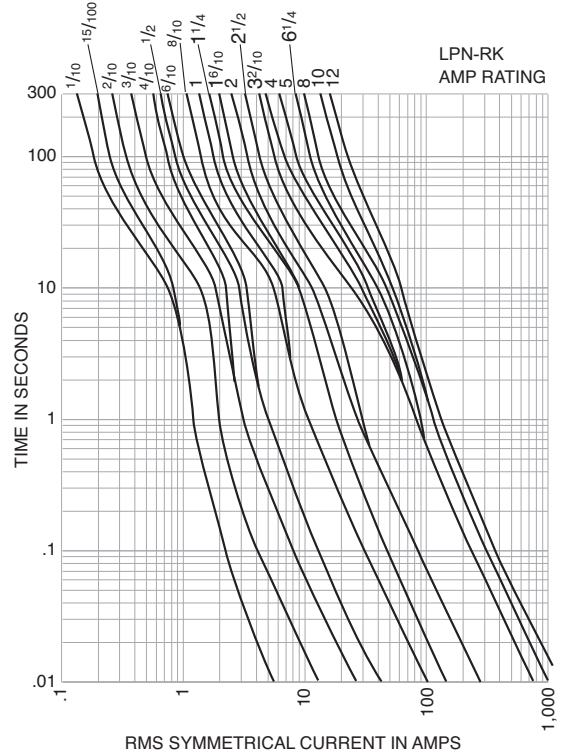
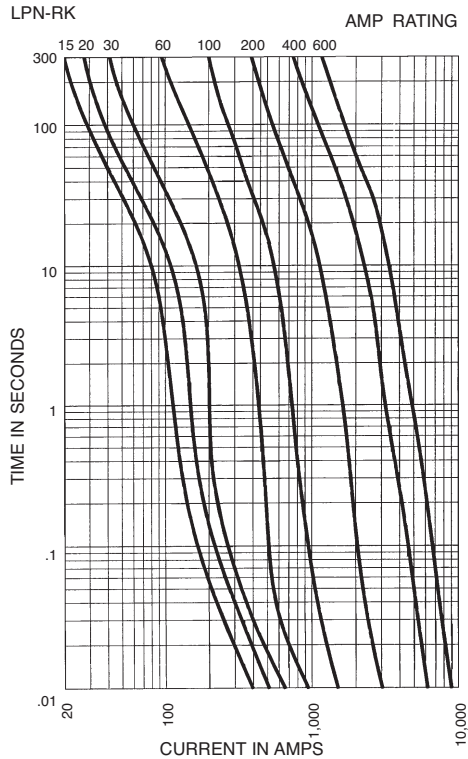

Data Sheets: LPN-RK — 1003 (0-60) and 1004 (70-600)
Data Sheets: LPS-RK — 1001 (0-60) and 1002 (70-600)

Recommended Fuse Holders & Blocks For Class RK1 Fuses
• See page 19

Low-Peak™ Dual-element, Time-delay Fuses

Low Voltage
Branch Circuit
Fuses

Current Limitation Curves—LPN-RK

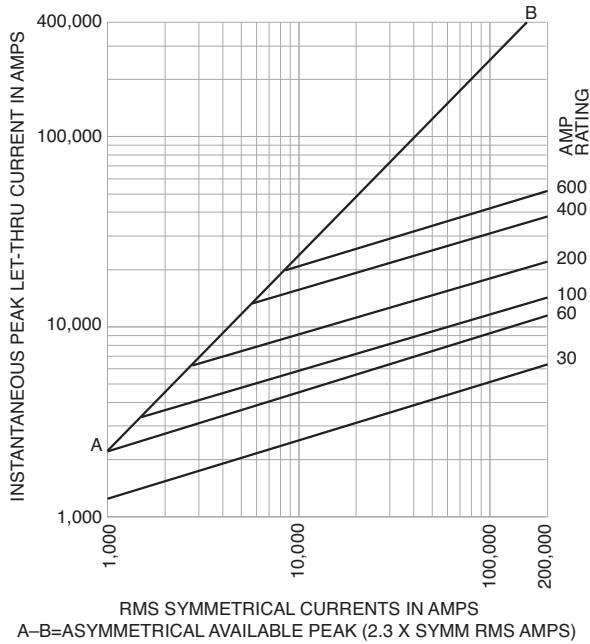

Current Limitation Curves—LPS-RK

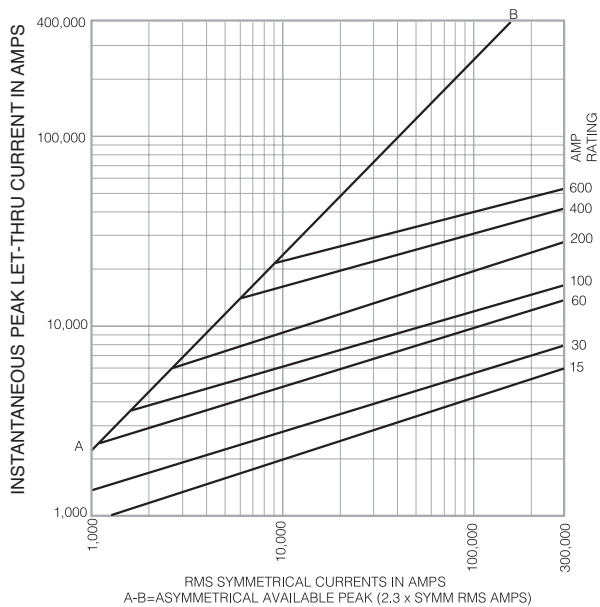

Data Sheets: LPN-RK — 1003 (0-60) and 1004 (70-600)
Data Sheets: LPS-RK — 1001 (0-60) and 1002 (70-600)

Recommended Fuse Holders & Blocks For Class RK1 Fuses
• See page 19

Limitron™ Fast-acting Fuses

KTN-R (250V) Class RK1

Specifications

Description: Fast-acting, current-limiting fuse.

Dimensions: See page 21 for Class RK1 dimensions.

Ratings:

- Volts — 250Vac (or less)
- Amps — 1-600A
- IR — 200kA RMS Sym.

Agency Information: CE, Std. 248-12, Class RK1, UL Listed, Guide JDDZ, File E4273, CSA Certified, Class 1422-02, File 53787.

Features and Benefits

- Current limitation for non-inductive circuits provides Class RK1 current-limiting response to maximum ground fault and short-circuit conditions.
- 200kA interrupting rating provides high ratings at all circuit locations.
- Economical solutions for high-fault circuits.

Typical Applications

- Panelboards

Catalog Numbers (Amps)

KTN-R-1	KTN-R-30	KTN-R-125
KTN-R-2	KTN-R-35	KTN-R-150
KTN-R-3	KTN-R-40	KTN-R-175
KTN-R-4	KTN-R-45	KTN-R-200
KTN-R-5	KTN-R-50	KTN-R-225
KTN-R-6	KTN-R-60	KTN-R-250
KTN-R-8	KTN-R-70	KTN-R-300
KTN-R-10	KTN-R-75	KTN-R-350
KTN-R-12	KTN-R-80	KTN-R-400
KTN-R-15	KTN-R-90	KTN-R-450
KTN-R-20	KTN-R-100	KTN-R-500
KTN-R-25	KTN-R-110	KTN-R-600

For superior electrical protection, Bussmann recommends upgrading KTN-R fuse applications to Low-Peak LPN-RK fuses See page 41.

Recommended Fuse Holders & Blocks For Class RK1 Fuses

- See page 19

Time-Current Characteristic Curves—Average Melt

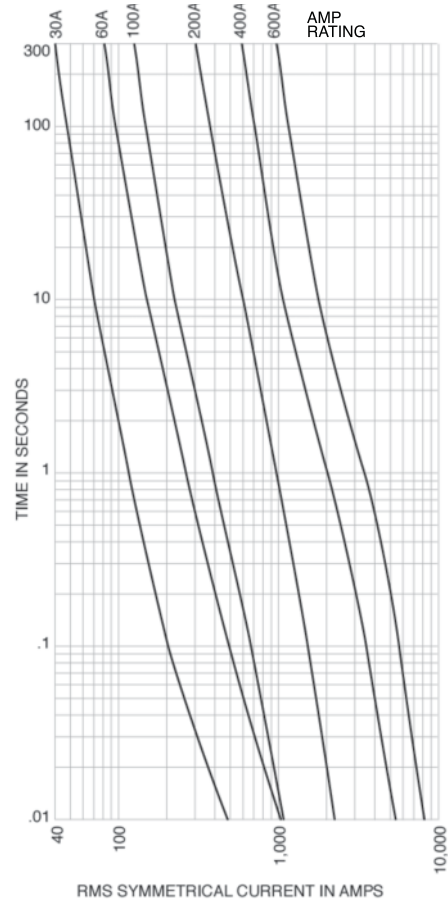

Current Limitation Curves

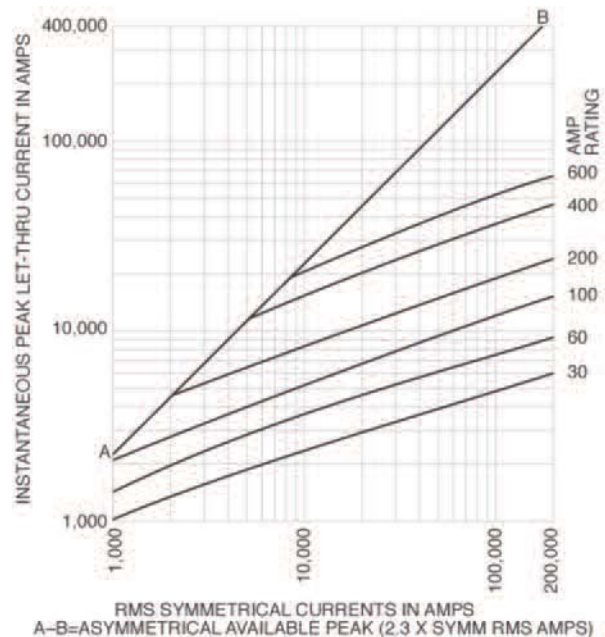

Limitron™ Fast-acting Fuses

KTS-R (600V) Class RK1

Specifications

Description: Fast-acting, current-limiting fuse.

Dimensions: See page 21 for Class RK1 dimensions.

Ratings:

- Volts — 600Vac (or less)
- Amps — 1-600A
- IR — 200kA RMS Sym.

Agency Information: CE, Std. 248-12, Class RK1, UL Listed, Guide JDDZ, File E54273, CSA Certified, C22.2 No. 248.12, Class 1422-02, File 53787.

Features and Benefits

- Current limitation for non-inductive circuits provides Class RK1 current-limiting response to maximum ground fault and short-circuit conditions.
- 200kA interrupting rating provides high ratings at all circuit locations.
- Economical solutions for high-fault circuits.

Typical Applications

- Panelboards

Catalog Numbers (Amps)

KTS-R-1	KTS-R-30	KTS-R-125
KTS-R-2	KTS-R-35	KTS-R-150
KTS-R-3	KTS-R-40	KTS-R-175
KTS-R-4	KTS-R-45	KTS-R-200
KTS-R-5	KTS-R-50	KTS-R-225
KTS-R-6	KTS-R-60	KTS-R-250
KTS-R-8	KTS-R-70	KTS-R-300
KTS-R-10	KTS-R-75	KTS-R-350
KTS-R-12	KTS-R-80	KTS-R-400
KTS-R-15	KTS-R-90	KTS-R-450
KTS-R-20	KTS-R-100	KTS-R-500
KTS-R-25	KTS-R-110	KTS-R-600



Time-Current Characteristic Curves—Average Melt

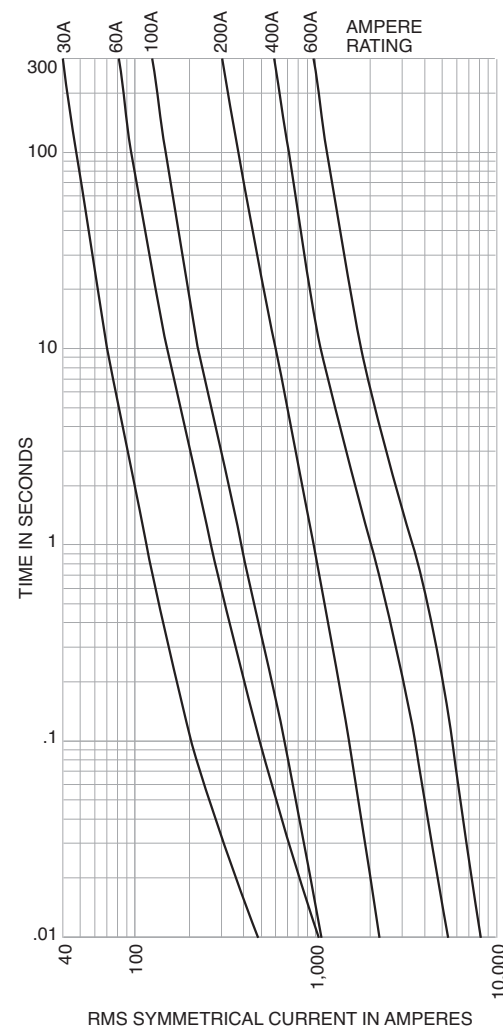

Current-Limitation Curves

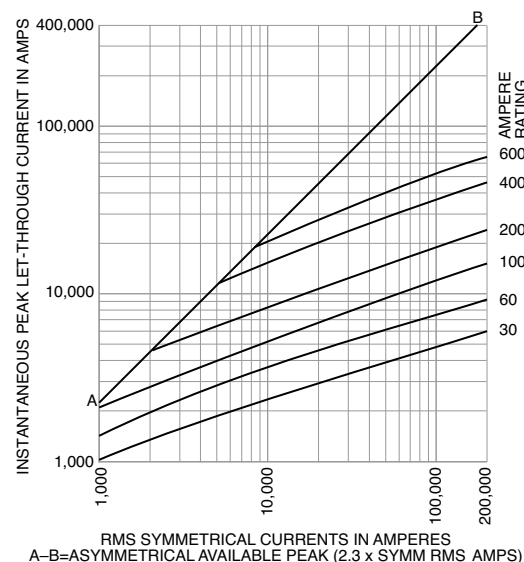

For superior electrical protection, Bussmann recommends upgrading KTN-R fuse applications to Low-Peak LPN-RK fuses See page 41.

Recommended Fuse Holders & Blocks For Class RK1 Fuses

- See page 19

Fusetron™ Energy Efficient, Dual-element, Time-delay Fuses

FRN-R (250V) Class RK5

Specifications

Description: Dual-element, time-delay fuse – 10 seconds (minimum) at 500% rated amps (8 seconds for 0-30A sizes). Available with indication on select ratings (see Catalog Numbers table).

Dimensions: See page 15 for Class RK5 dimensions.

Ratings:

- Volts — 250Vac (or less)
 - 125Vdc (1/10-60A, 110-200A)
 - 250Vdc (225-600A)
- Amps — 1/10-600A
 - IR — 200kA RMS Sym.
 - 20kA DC



Available
With
Indication



Time-Current Characteristic Curves—Average Melt

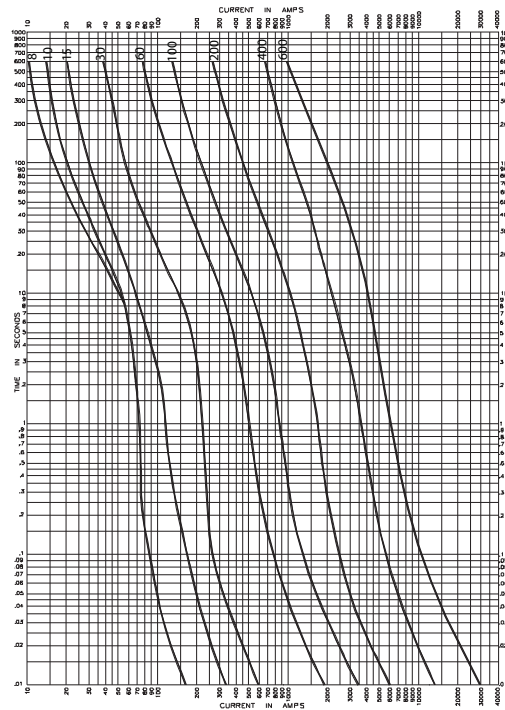

Agency Information: CE, Std. 248-12, Class RK5, UL Listed, Guide JDDZ, File E4273, CSA Certified, Class 1422-01, File 53787.

Features and Benefits

- Separate overload and short-circuit elements provide time delay for sizing as close as 125% of motor FLA.
- 2:1 selective coordination amp ratio (within the Cooper Bussmann RK5 fuse family) prevents overcurrent events from opening upstream Fusetron fuses.
- Insulated end caps for 225A-600A fuses reduces exposure to live parts and extends air gap to distance between blades of adjacent mounted fuses or to housing.

Typical Applications

- Power Panelboards
- Motor Control Centers
 - Combination Starters
 - Machinery Disconnects

Catalog Numbers (Amps)

FRN-R-1/10	FRN-R-2	FRN-R-10*	FRN-R-100
FRN-R-1/8	FRN-R-2-1/4	FRN-R-12*	FRN-R-110
FRN-R-1/100	FRN-R-2-1/2	FRN-R-15*	FRN-R-125
FRN-R-3/10	FRN-R-2-3/10	FRN-R-17-1/2*	FRN-R-150
FRN-R-1/4	FRN-R-3	FRN-R-20*	FRN-R-175
FRN-R-3/10	FRN-R-3-3/10	FRN-R-25*	FRN-R-200
FRN-R-1/10	FRN-R-3-1/2	FRN-R-30*	FRN-R-225
FRN-R-1/2	FRN-R-4	FRN-R-35*	FRN-R-250
FRN-R-3/10	FRN-R-4-1/2	FRN-R-40*	FRN-R-300
FRN-R-1/10	FRN-R-5	FRN-R-45*	FRN-R-350
FRN-R-1	FRN-R-5-1/10	FRN-R-50*	FRN-R-400
FRN-R-1-1/2	FRN-R-6	FRN-R-60*	FRN-R-450
FRN-R-1-1/4	FRN-R-6-1/4	FRN-R-70	FRN-R-500
FRN-R-1-1/10	FRN-R-7	FRN-R-75	FRN-R-600
FRN-R-1-1/2	FRN-R-7-1/2	FRN-R-80	
FRN-R-1-1/10	FRN-R-8*	FRN-R-85	
FRN-R-1-1/10	FRN-R-9*	FRN-R-90	

*Available with indication. To order, place "ID" at the end of the catalog number. Example: FRN-R-30ID

Current Limitation Curves

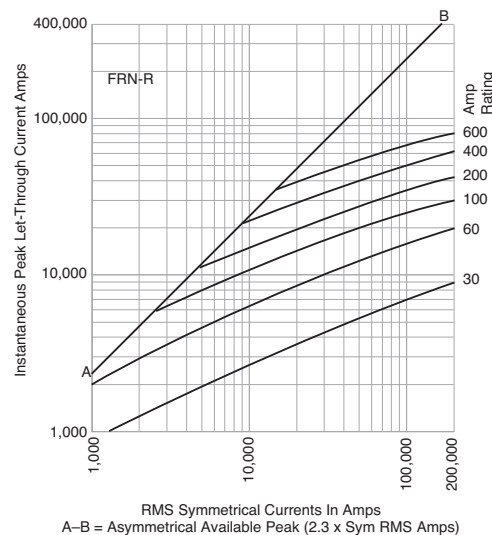

For superior electrical protection, Bussmann recommends upgrading FRN-R fuse applications to Low-Peak LPN-RK fuses. See page 41.

Recommended Fuse Holders & Blocks For Class RK5 Fuses

- See page 19

Recommended Fuse Reducers For Class R Fuses

- See page 20

Data Sheets: 1019 (1/10-60) and 1020 (70-600)
Data Sheet: 1169 (8-60) FRN-R with indication

Fusetron™ Energy Efficient, Dual-element, Time-delay Fuses

FRS-R (600V) Class RK5

Specifications

Description: Dual-element, time-delay fuse – 10 seconds (minimum) at 500% rated amps. Now available with optional indication on select ratings (see Catalog Numbers table).

Dimensions: See page 15 for Class RK5 dimensions.

Ratings:

- Volts — 600Vac (or less)
- Amps — 1/10-30A
 - IR — 200kA RMS Sym.
 - 20kA @300Vdc
- Amps — 35-60A
 - IR — 200kA RMS Sym.
 - 20kA @250Vdc
- Amps — 65-600A
 - IR — 200kA RMS Sym.
 - 20kA @250Vdc



Available With Indication



Agency Information: CE, Std. 248-12, Class RK5, UL Listed, Guide JDDZ, File E4273, CSA Certified, Class 1422-02, File 53787.

Features and Benefits

- 2:1 selective coordination ratio (within RK5 fuse family) prevents electrical shutdowns from extending beyond the failed circuit.
- Insulated end caps for 65-600A fuses reduces exposure to live parts and extends air gap to distance between blades of adjacent mounted fuses or to housing.

Typical Applications

- Power Panelboards
- Motor Control Centers
- Combination Starters
- Machinery Disconnects

Catalog Numbers (Amps)

FRS-R-1/10	FRS-R-2	FRS-R-10*	FRS-R-100
FRS-R-1/8	FRS-R-2-1/4	FRS-R-12*	FRS-R-110
FRS-R-1/100	FRS-R-2-1/2	FRS-R-15*	FRS-R-125
FRS-R-1/10	FRS-R-2-3/10	FRS-R-17-1/2*	FRS-R-150
FRS-R-1/4	FRS-R-3	FRS-R-20*	FRS-R-175
FRS-R-3/10	FRS-R-3-3/10	FRS-R-25*	FRS-R-200
FRS-R-1/10	FRS-R-3-1/2	FRS-R-30*	FRS-R-225
FRS-R-1/2	FRS-R-4	FRS-R-35*	FRS-R-250
FRS-R-5/10	FRS-R-4-1/2	FRS-R-40*	FRS-R-300
FRS-R-1/10	FRS-R-5	FRS-R-45*	FRS-R-350
FRS-R-1	FRS-R-5-3/10	FRS-R-50*	FRS-R-400
FRS-R-1-1/8	FRS-R-6*	FRS-R-60*	FRS-R-450
FRS-R-1-1/4	FRS-R-6-1/2*	FRS-R-65	FRS-R-500
FRS-R-1-3/10	FRS-R-7*	FRS-R-70	FRS-R-600
FRS-R-1-1/2	FRS-R-7-1/2*	FRS-R-75	
FRS-R-1-5/10	FRS-R-8*	FRS-R-80	
FRS-R-1 1/10	FRS-R-9*	FRS-R-90	

*Available with indication. To order, place "ID" at the end of the catalog number. Example: FRS-R-7ID.

For superior electrical protection, Bussmann recommends upgrading FRS-R fuse applications to Low-Peak LPS-RK fuses. See page 41.

Data Sheet: 1017 (1/10-60), 1018 (65-600)
Data Sheet: 1070 (6-60) FRS-R with Indication

Time-Current Characteristic Curves—Average Melt

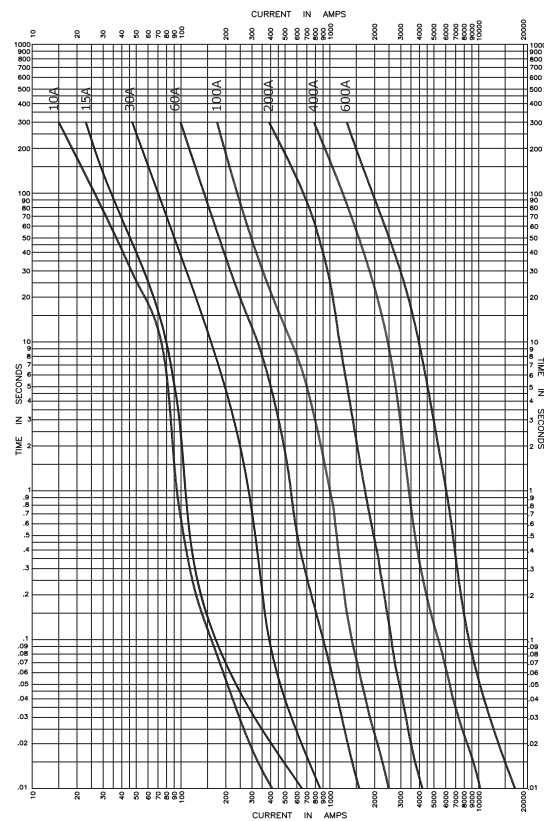

Current Limitation Curves

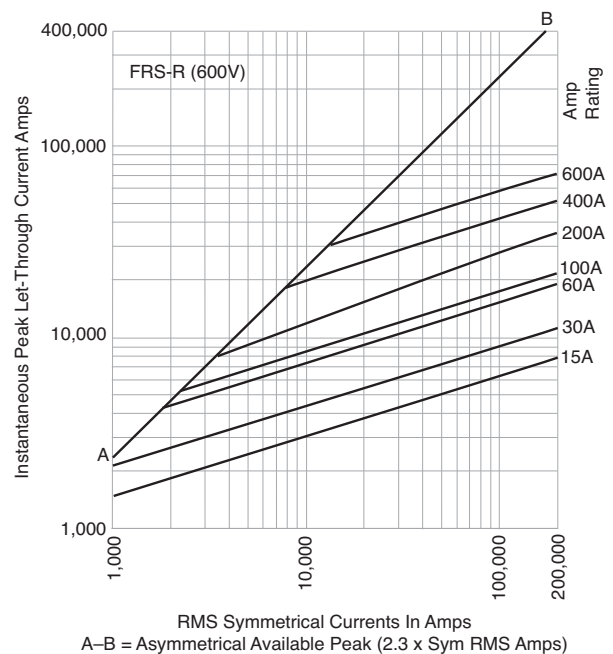

Recommended Fuse Holders & Blocks For Class RK5 Fuses

• See page 19

Recommended Fuse Reducers For Class R Fuses

• See page 20

Low Voltage Branch Circuit Fuses

T-Tron™ Fast-acting Fuses

JJN Class T

Specifications

Description: Fast-acting, current-limiting fuse.

Dimensions: See page 16 for Class T dimensions.

Ratings:

- Volts — 300Vac (or less)
- 160Vdc (15-600A)
- 170Vdc (601-1200A)
- Amps — 1-1200A
- IR — 200kA RMS Sym.
- 20kA DC @ 160Vdc
- 100kA DC @ 170Vdc

Agency Information: CE, Std. 248-15, Class T, UL Listed, Guide JDDZ, File E4273, CSA Certified, Class 1422-02, File 53787.

Features and Benefits

- Series combination ratings with branch circuit breakers allows broad range of coverage, independent of breaker manufacturer.
- Current limitation for non-inductive circuits provides Class T current-limiting response to maximum ground fault and short-circuit conditions.
- 200kA interrupting rating provides high ratings at all circuit locations.
- Small footprint allows more efficient use of available space.

Typical Applications

- Large Apartment Complexes
- Multi-Family Meter Stacks
- VFD Line Protection

Catalog Numbers (Amps)

JJN-1	JJN-15	JJN-40	JJN-80	JJN-150	JJN-300	JJN-600
JJN-2	JJN-20	JJN-45	JJN-90	JJN-175	JJN-350	JJN-700
JJN-3	JJN-25	JJN-50	JJN-100	JJN-200	JJN-400	JJN-800
JJN-6	JJN-30	JJN-60	JJN-110	JJN-225	JJN-450	JJN-1000
JJN-10	JJN-35	JJN-70	JJN-125	JJN-250	JJN-500	JJN-1200

Recommended Fuse Holders & Blocks For Class T Fuses

- See page 19



Time-Current Characteristic Curves—Average Melt

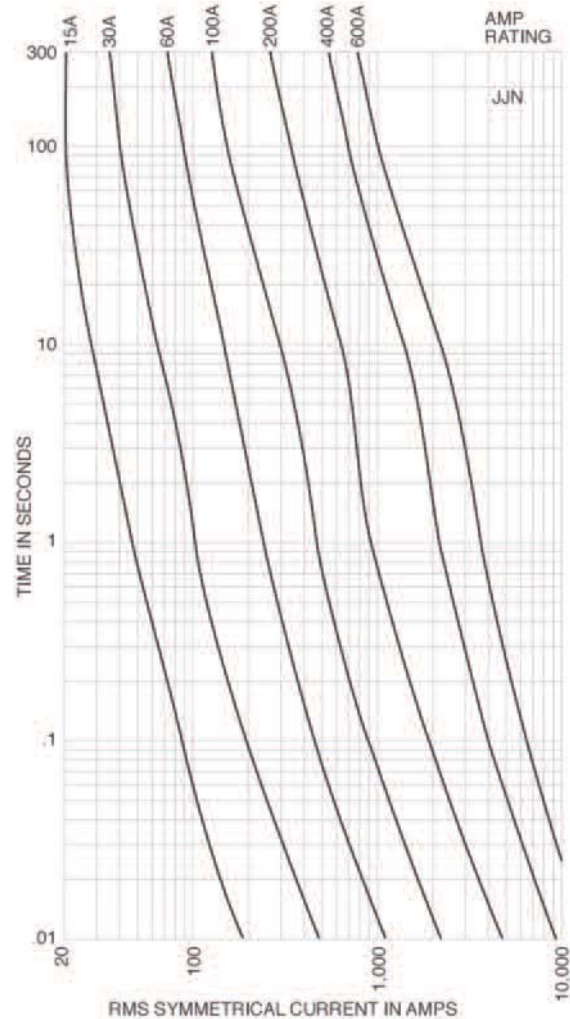

Current Limitation Curves

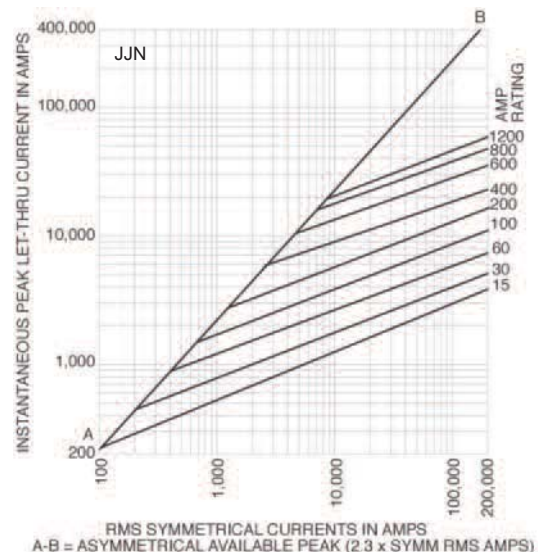

T-Tron™ Fast-acting Fuses

JJS Class T

Specifications

Description: Very fast-acting, current-limiting fuse.

Dimensions: See page 16 for Class T dimensions.

Ratings:

- Volts — 600Vac (or less)
- Amps — 1-800A
- IR — 200kA RMS Sym.

Agency Information: CE, Std. 248-15, Class T, UL Listed, Guide JDDZ, File E4273, CSA Certified, Class 1422-02, File 53787.

Features and Benefits

- Series combination ratings with branch circuit breakers allows broad range of coverage, independent of breaker manufacturer.
- Current limitation for non-inductive circuits provides Class T current-limiting response to maximum ground fault and short-circuit conditions.
- 200kA interrupting rating provides high ratings at all circuit locations.
- Small footprint allows more efficient use of available space.

Typical Applications

- Large Apartment Complexes
- Multi-Family Meter Stacks
- VFD Line Protection

Catalog Numbers (Amps)

JJS-1	JJS-15	JJS-40	JJS-80	JJS-150	JJS-300	JJS-600
JJS-2	JJS-20	JJS-45	JJS-90	JJS-175	JJS-350	JJS-800
JJS-3	JJS-25	JJS-50	JJS-100	JJS-200	JJS-400	
JJS-6	JJS-30	JJS-60	JJS-110	JJS-225	JJS-450	
JJS-10	JJS-35	JJS-70	JJS-125	JJS-250	JJS-500	



Time-Current Characteristic Curves—Average Melt

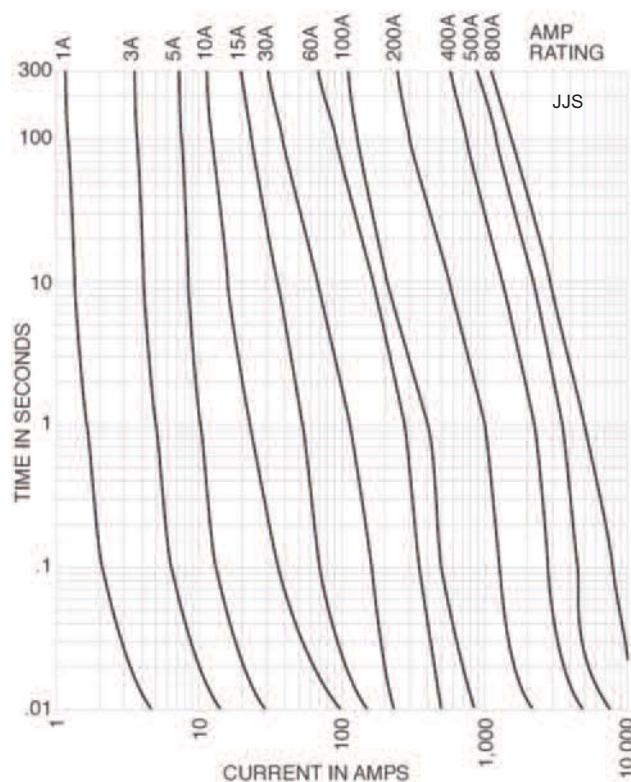

Current Limitation Curves

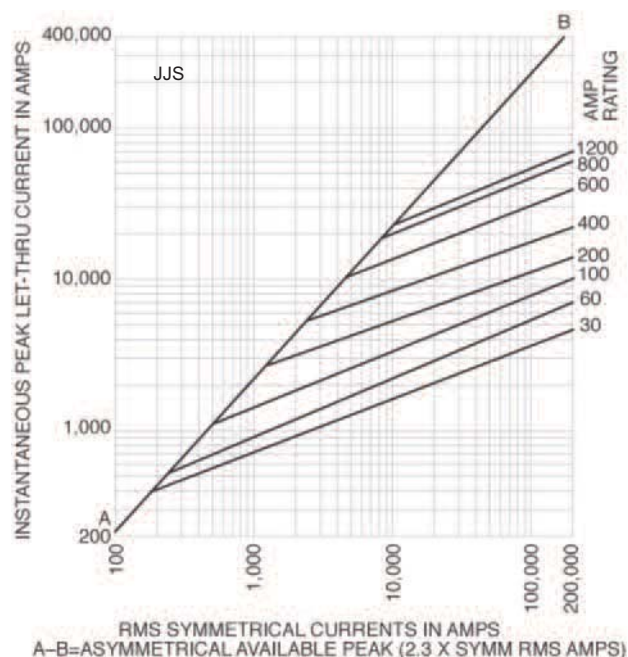

Recommended Fuse Holders & Blocks For Class T Fuses

- See page 19

Data Sheet: 1029

Plug Fuses

W Series

Specifications

Description: Fast-acting plug fuse.

Dimensions: Edison base plug.

Construction: Brass threads with plastic body.

Ratings:

Volts — 125Vac

Amps — ½-12A

IR — 10kA RMS Sym.

Agency Information: CE, Std. 248-11, UL Listed, Guide JEFV, File E12112.

Features and Benefits

- Dependable, fast-acting circuit protection with 10kA interrupting rating for added safety when applied to existing plug fuse systems and 125-volt single-phase control circuits.

Typical Applications

- Replacement only in existing systems.
- For general purpose circuit protection.
- Use for lighting and other non-motor circuits.

Catalog Numbers* (Amps)

W-½	W-2 ½	W-6	W-10
W-1	W-3	W-6 ½	W-12
W-1 ⅓	W-4	W-7	W-DUMMY**
W-2	W-5	W-8	

*W-15, W-20, W-25, and W-30 plug fuses obsoleted. Suggest replacing with either T-(Amp) or TL-(Amp) plug fuses.

** Non-conductive dummy base. Not a fuse.



SL and TL Series

Specifications

Description: Time-delay, loaded link plug fuse.

Dimensions:

SL — Rejection base

TL — Edison base

Construction:

SL — Plastic base with rejection threads

TL — Brass threads with plastic body

Ratings:

Volts — 125Vac

Amps — 15-30A

IR — 10kA RMS Sym.

Agency Information: CE, Std. 248-11, UL Listed, Guide JEFV, File E12112.

Features and Benefits

- Time-delay loaded link TL Series Edison base plug fuses pass motor overload starting currents without opening and allow closer sizing to motor load for added protection.
- Time-delay loaded link SL Series fuses provide a rejection feature (when used alone or with Fustat adapters to retrofit Edison base holders) to help prevent overfusing.

Typical Applications

- Small motor and inductive load circuits with high in-rush current levels.
- Used with box cover units to provide equipment protection.
- Applications benefiting from fuse rejection (SL Series only).

SL Catalog Numbers (Amps)

SL-15 SL-20 SL-25 SL-30

TL Catalog Numbers (Amps)

TL-15 TL-20 TL-25 TL-30



Data Sheet: 1036

Recommended Fuse Holders For W Series Plug Fuses

- See page 20

Data Sheets: 1033 (SL) & 1035 (TL)

Recommended Fuse Holders For SL & TL Series Plug Fuses

- See page 20
- See page 52 for Fustat adapters for use with SL Series

Plug Fuses

Low Voltage
Branch Circuit
Fuses

S and T Series

Specifications

Description: Dual-element, time-delay plug fuse.

Dimensions:

- S — Rejection base
- T — Edison base

Construction:

- S — Plastic base with rejection threads
- T — Brass threads with plastic body

Ratings:

- Volts — 125Vac
- Amps — S Series: ¼-30A
- T Series: ⅓-30A
- IR — 10kA RMS Sym.

Agency Information: CE, Std. 248-11, Type S and T; UL Listed (0-6¼) Guide JFHR, File E56412 (7-30A) Guide JEFV, File E12112; CSA Certified, Class 1423-01, File 53787.

Features and Benefits

- Time-delay, dual-element T Series Edison base plug fuses provide small motor overload protection when used with box cover units.
- Time-delay, dual-element S Series plug fuses provide a rejection feature (when used alone or with Fustat adapters to retrofit Edison base holders) to prevent overfusing of branch circuits.

Typical Applications

- S Series — Residential Load Centers
- T Series — Box Cover Units for small motor overload protection
- Applications benefiting from fuse rejection (S Series only)

S Series Catalog Numbers (Amps)

S-¼	S-⅓	S-1-⅓	S-2-½	S-4	S-7	S-14
S-⅓	S-1	S-1-⅓	S-2-⅓	S-4-½	S-8	S-15
S-⅓	S-1-½	S-2	S-3	S-5	S-9	S-20
S-½	S-1-¼	S-2-¼	S-3-⅓	S-6	S-10	S-25
S-⅓	S-1-⅓	S-5-⅓	S-3-½	S-6-¼	S-12	S-30

T Series Catalog Numbers (Amps)

T-⅓	T-1-½	T-2-¼	T-4	T-7	T-15
T-⅓	T-1-¼	T-2-½	T-4-½	T-8	T-20
T-½	T-1-⅓	T-2-⅓	T-5	T-9	T-25
T-⅓	T-1-⅓	T-3	T-5-⅓	T-10	T-30
T-⅓	T-1-⅓	T-3-⅓	T-6	T-12	
T-1	T-2	T-3-½	T-6-¼	T-14	

Data Sheet: 1032 (S) & 1034 (T)

Recommended Fuse Holders For S & T Series Plug Fuses

- See page 20
- See page 52 for Fustat adapters for use with S Series

P & TC Series

Specifications

Description:

P Series - Type P dual-element fuse
TC Series - Type D dual-element, time-delay fuse

Dimensions: Edison base

Construction: Brass threads with plastic body.

Ratings:

- Volts — 125Vac or less
- Amps — 15-30A
- IR — 10kA

Agency Information:

P Series - CSA Certified
TC Series - CSA Certified (Class 1423-01, File # 53787)

Features and Benefits

P Series

- “P” Rating for Canadian applications.
- Non-time delay for non-inductive loads

TC Series

- “D” Rating for Canadian applications
- Heavy duty TC fuses are industrial strength products, featuring dual-element construction.
- This spring loaded design provides superior short-circuit and overload protection.
- The TC fuses have more time-delay than the medium duty fuses in order to better protect industrial motors and residential circuits.

Typical Applications

- P Series — Non-inductive loads, residential load centers
- TC Series — Box Cover Units for small motor overload protection

P Series Catalog Numbers (Amps)

P-15	P-20	P-25	P-30
------	------	------	------

TC Series Catalog Numbers (Amps)

TC-15	TC-20	TC-25	TC-30
-------	-------	-------	-------

Data Sheet: 1039 (TC Series only)

Recommended Fuse Holders For P & TC Series Plug Fuses

- See page 20
- See page 52 for Fustat adapters for use with S Series

Plug Fuses

MB Edison Base Circuit Breakers



Specifications

Description: Edison base manual reset circuit breakers.

Dimensions: Edison base

Construction: Brass threads with plastic body

Ratings:

- Volts — 125Vac only
- Amps — 15-20A
- IR — 10kA RMS Sym.

Agency Information: UL Listed, File E14942

Features and Benefits

- Fit standard Edison base fuse receptacles.
- Resettable upon overload event.

Typical Applications*

- Replacing Edison base plug fuses in residential fuse panels.

Catalog Numbers* (Amps)

MB-15
MB-20

* Not for use in box cover units or for inductive loads.

SA Fustat Fuse Adapters



Specifications

Description: Adapters for using Type S and SL rejection fuses in Edison base fuse sockets.

Agency Information: UL Listed, File E12853; CSA Certified File #6225-01, File #47235.

Features and Benefits

- Fustat adapters screw into the “Edison” thread fuse sockets of standard fuse boxes making it easy to retrofit existing fuse installations
- Available in various amp ratings to cover a wide range of rating requirements

Typical Applications

- Plug fuse installations where it is desirable to restrict fuse amp ratings

Catalog Numbers (Amps)

SA-1*	SA-3- ³ / ₁₀ *	SA-10*
SA-1- ¹ / ₄ *	SA-4*	SA-15**
SA-1- ¹ / ₁₀ *	SA-5*	SA-20**
SA-2*	SA-6- ¹ / ₂ *	SA-30**
SA-2- ¹ / ₂ *	SA-8*	

* Single motor circuits.

** Branch circuits.

Fustat® Adapters for Small Motor Protection*

Adapter	Accepts Fuses
SA-1	S-1 or smaller
SA-1- ¹ / ₄	S-1- ¹ / ₄ or smaller
SA-1- ¹ / ₁₀	S-1- ¹ / ₁₀ or smaller
SA-2	S-2 or S-1- ¹ / ₁₀
SA-2- ¹ / ₂	S-2- ¹ / ₂ to S-1- ¹ / ₁₀
SA-3- ³ / ₁₀	S-3- ³ / ₁₀ to S-1- ¹ / ₁₀
SA-4	S-4 to S-3- ¹ / ₂
SA-5	S-5 to S-3- ¹ / ₂
SA-6- ¹ / ₂	S-6- ¹ / ₂ to S-3- ¹ / ₂
SA-8	S-8 to S-7
SA-10	S-10 to S-7
SA-15	S-15 to S-7
SA-20	S-20
SA-30	S-30 to S-20

* Both motor running and short-circuit protection.

Fustat® Adapters for Branch Circuit Protection

Adapter	Accepts Fuses
SA-15	S-15 to S-7
SA-20	S-20
SA-30	S-25
SA 30	S-30 to S-20



Scan this tag to get the latest product information for Solar Products.

Solar Fuse Products

Page
54-55

Fuse Holder & Block Selection Guide

Volt	Fuses	Size	
600Vdc	PVM	$1\frac{1}{32}'' \times 1\frac{1}{2}''$	56
600Vac /300Vdc	PVCF	CUBEFuse	57-58
600Vac/dc	PVS-R	RK5	59
1000Vdc	PV	10x38mm	60
1000/1100Vdc	PV	14x51mm	61
1000Vdc	NH1	NH Size 1	62
1000Vdc	XL PV	XL Size 01, 1, 2, 3	63-65
1300/1500Vdc	PV	14x65mm	66
1200/1500Vdc	XL PV	XL Size 01, 1, 2, 3	67-69

RED indicates **NEW** information



Holders & Blocks For Branch Circuit Rated Fuses

600 Volts	Fuses	Volts	Page
Midget	PVM	600V	56
CF	CFPV	600V	57
RK5	PVS-R	600V	59

Holders

- TCFH Series CUBEFuse holder 32
- CHM Series DIN-Rail mount holders 274
- HEB Series in-line holders 310

Blocks

- Modular Knifeblade Fuse Blocks 250/600V, panel mount . . 289
- R600 Series RK5 open fuse blocks 296
- BM Series midget open fuse blocks 305



CHM Series



HEB Series



TCFH Series



BM Series



Modular Knifeblade



R600 Series

1000 Volts	Fuses	Volts	Page
10x38mm	PV-_A10	1000V	60
14x51mm	PV-_A14	1000/1100V	61
NH1	PV-_ANH	1000V	62
01XL	PV-_A-01XL	1000V	63
1XL	PV-_A-1XL	1000V	63
2XL	PV-_A-2XL	1000V	63
3L	PV-_A-3L	1000V	63

Holders

- CHPV Series 10x38 DIN-Rail mount holders 274-277
- CH14 Series 14x51 DIN-Rail mount holders 274-277
- HEB Series* 10x38 in-line holders 310
- SD1 Series** NH1 holders 63

* Self certified to 1000Vdc.

** IEC only to 1000Vdc.

Blocks

- SD1XL-S Series 01XL & 1XL blocks 63
- SD2XL-S Series 2XL blocks 63
- SD3L-S Series 3L blocks 63



CHPV Series



CH14 Series



HEB Series



SD1-D-PV Series



SD1XL-S Series



SD2XL-S Series



SD3L-S Series

Holders & Blocks For Branch Circuit Rated Fuses

1500 Volts	Fuses	Volts	Page
01XL	PV-_A-01XL-15	1500V	63
1XL	PV-_A-1XL-15	1500V	63
2XL	PV-_A-2XL-15	1500V	63
3L	PV-_A-3L-15	1500V	63
14x65mm	PV-_A14*	1300/1500V	66

Blocks

- SD1XL-S Series** 01XL & 1XL blocks 63
- SD2XL-S Series** 2XL blocks 63
- SD3L-S Series** 3L blocks 63

* Available with tags for bolt mounting or 10mm fixings for mounting in modular blocks for 10mm diameter fuses.

** IEC only to 1500Vdc.



SD1XL-S Series



SD2XL-S Series



SD3L-S Series

1 3/32" x 1 1/2" Midget PV Fuses

PVM

Specifications

Description: A range of UL 2579 fast-acting 600Vdc Midget fuses specifically designed to protect solar power systems in extreme ambient temperature, high cycling and low level fault current conditions (reverse current, multi-array fault).

Dimensions: 1 3/32" x 1 1/2"
(10.3 x 38.1mm).

Ratings:

Volts — 600Vdc to UL 2579

Amps — 4-30A

IR — 50kA DC (4-30A)

Agency Information: UL Listed 2579, Guide JFGA, File E335324, CSA Component Certified C22.2.

Features and Benefits

- Specifically designed to protect solar power systems in extreme ambient temperature per UL 2579 listed
- Capable of withstanding high cycling and low level fault current conditions

Typical Applications

- Solar Combiner Boxes
- Solar String Protectors

Power Loss (Watts)

Catalog Number	Amp Rating	Power Loss (Watts)	
		0.8 x I _n	1.0 x I _n
PVM-10	10	1.04	1.86
PVM-15	15	1.00	1.72
PVM-30	30	1.65	2.91

I_n = Rated current

Catalog Numbers (Amps)

PVM-4	PVM-7	PVM-10	PVM-20
PVM-5	PVM-8	PVM-12	PVM-25
PVM-6	PVM-9	PVM-15	PVM-30

Dimensions - (mm)

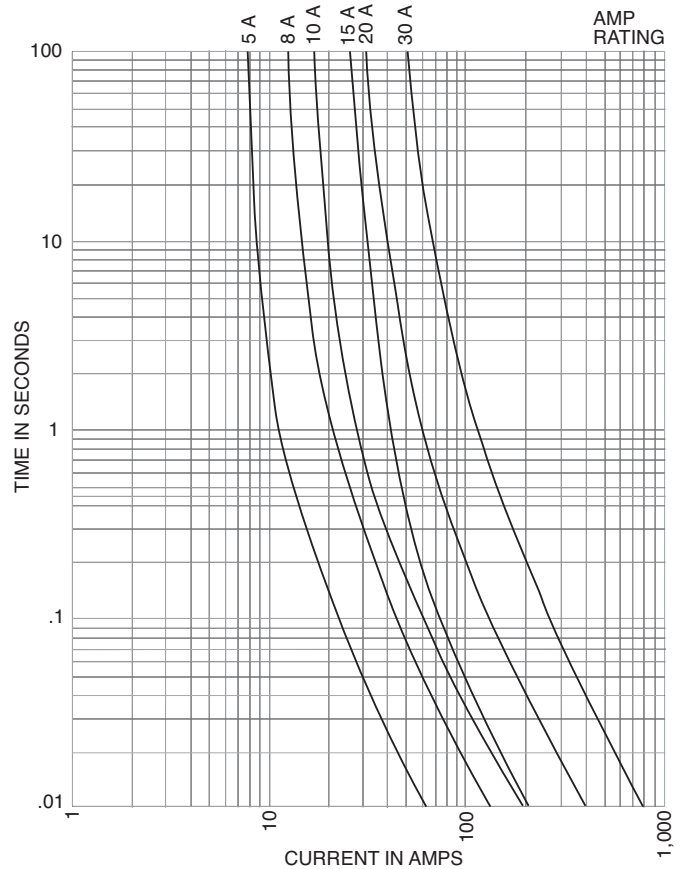
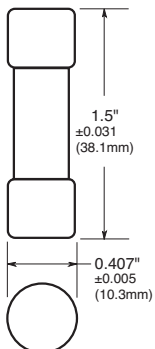

Recommended Fuse Holders & Blocks For the PVM Fuse

- See page 54

Fast-Acting CUBEFuse™

PVCF Class CF Fuse



Catalog Symbol: PVCF_RN

Fast-Acting Fuse: 6 minutes maximum clearing time at 200% rated current for 30 to 60A fuse
8 minutes maximum clearing time at 200% rated current for 70 to 100A fuse

Ratings:

- Volts — 600Vac (Photovoltaic applications)
- 300Vdc
- Amps — 35-100A
- IR — 300kA RMS Sym. (UL)
- 200kA RMS Sym. (CSA)
- 50kA DC (UL & CSA)

Agency Information:

- UL 2579 Listed Fuse: Guide JFGA, File E335324
- CSA Certified Fuse: Class C22.2

Other Ratings/Specifications:

Watts Loss at Rated Current: PVCF35RN: 5.45W
PVCF60RN: 7.27W
PVCF100RN: 11.50W

Operating and Storage Temperature Range: -40 to 90°C

Material Specifications:

- Case: Glass filled PES (Polyethersulfone)
- Terminals: Copper alloy
- Terminal plating: Electroless tin

Carton Quantity and Weight

Amp Rating	Carton Qty.	Weight Per Carton	
		lbs	kg
PVCF-35-60A	12	1.42	0.65
PVCF-70-100A	6	1.74	0.79

Features and Product Benefits

- Maximize uptime and reliability using fuses designed and listed to UL 2579: *Low Voltage Fuses - Fuses for Photovoltaic Systems*.
- Minimize chances of equipment failure and personnel injury when using full range fuses having the industry’s fastest response time to low-magnitude faults.
- Maximize return on investment with fuses proven to withstand harsh temperatures.
- Minimize design time, operating outage time and replacement cost with fuses qualified in excessively changing environmental conditions.
- Simplify compatibility with readily available industry standard Class CF holders.
- Temperature Derating: Designed to maximize rated capacity in elevated environmental temperatures.
- Overload Protection: Proven to clear faults faster than the UL requirement.
- Power Loss: Minimal energy consumption leading to increased efficiency.

Fuse Catalog Numbers Non-Indicating (Amps)

PVCF35RN	PVCF50RN	PVCF80RN
PVCF40RN	PVCF60RN	PVCF90RN
PVCF45RN	PVCF70RN	PVCF100RN



Scan this tag to get the latest product information for the New PVCF CUBEFuse.

Recommended Fuse Holders For Class CF Fuses

- See pages 32 and 33

Fast-Acting CUBEFuse™

PVCF_RN Dimensions – in (mm)

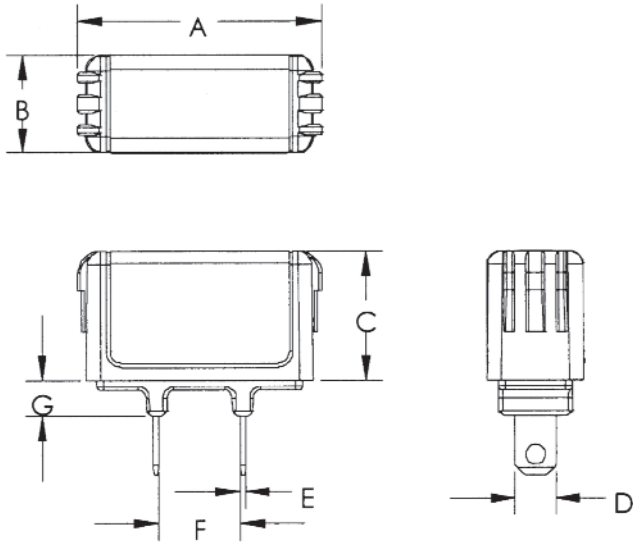

Fuse Amps	Dimensions - in (mm)						
	A	B	C	D	E	F	G
35-40	2.13 (54.10)	1.00 (25.40)	1.13 (28.58)	0.36 (9.10)	0.04 (1.02)	0.63 (15.93)	0.38 (9.65)
45-50	2.13 (54.10)	1.00 (25.40)	1.13 (28.58)	0.44 (11.13)	0.04 (1.02)	0.63 (15.93)	0.38 (9.65)
60	2.13 (54.10)	1.00 (25.40)	1.13 (28.58)	0.44 (11.13)	0.04 (1.02)	0.63 (15.93)	0.38 (9.65)
70	3.01 (76.45)	1.00 (25.40)	1.26 (32.00)	0.49 (12.45)	0.06 (1.60)	0.58 (14.78)	0.38 (9.65)
80-90	3.01 (76.45)	1.00 (25.40)	1.26 (32.00)	0.49 (12.45)	0.06 (1.60)	0.58 (14.78)	0.38 (9.65)
100	3.01 (76.45)	1.00 (25.40)	1.26 (32.00)	0.57 (14.48)	0.06 (1.60)	0.58 (14.78)	0.38 (9.65)

Time-Current Characteristic Curves—Average Melt

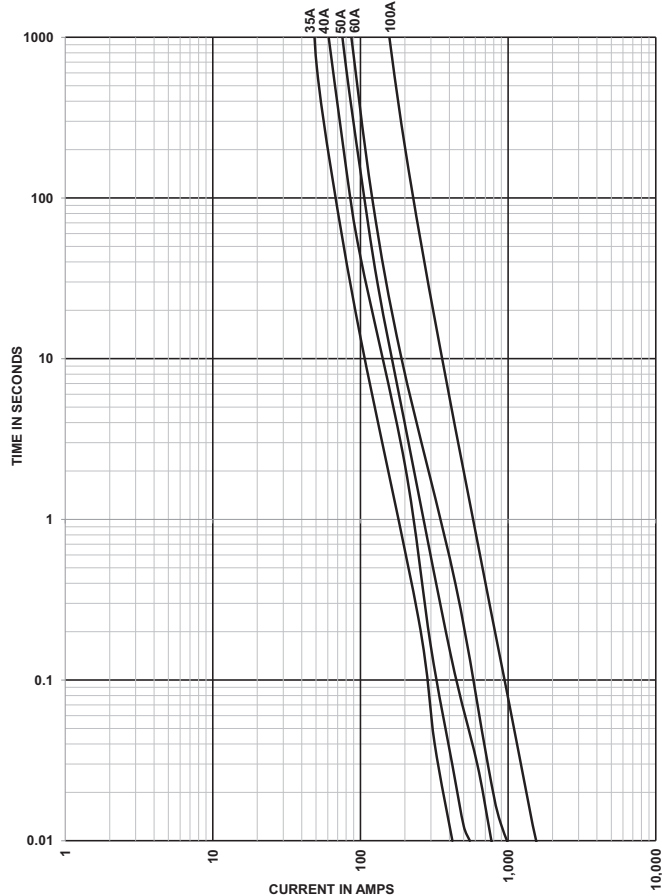

Current Limitation Curves

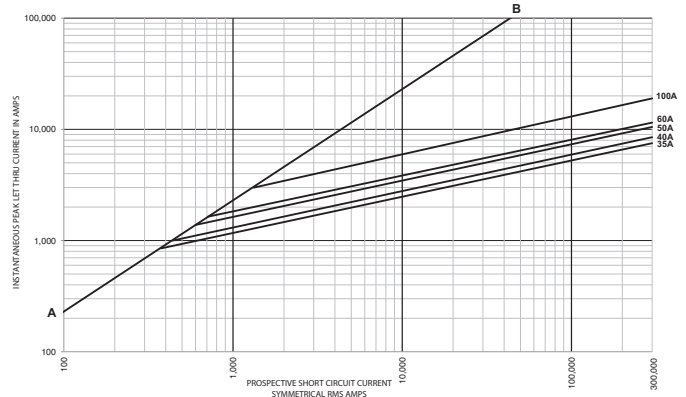

CUBEFuse Holders

Catalog Numbers (amps)	Fits Fuse Holder	
	TCFH60N	TCFH100N
Non-Indicating		
PVCF35RN	X	X
PVCF40RN	X	X
PVCF45RN	X	X
PVCF50RN	X	X
PVCF60RN	X	X
PVCF70RN		X
PVCF80RN		X
PVCF90RN		X
PVCF100RN		X

Limitron™ Fast-acting Fuses

PVS-R (600Vac/dc) Class RK5

Specifications

Description: A range of UL 2579 fast-acting 600Vdc Class RK5 fuses specifically designed to protect solar power systems in extreme ambient temperature, high cycling and low level fault current conditions (reverse current, multi-array fault).

Dimensions: See page 15 for Class RK5 dimensions.

Ratings:

- Volts — 600Vac to UL 248-12
600Vdc to UL 2579
- Amps — 20-400A
- IR — 200kA RMS Sym. AC
20kA DC (20-60A)
10kA DC (70-400A)

Agency Information: UL Std. 248-12, Class RK5, UL Listed, Guide JFGA, File E335324. Photovoltaic to UL 2579, CSA Component Certified C22.2.

Features and Benefits

- Current limitation for non-inductive circuits provides Class RK5 current-limiting response to ground fault and short-circuit conditions.
- Designed for the protection and isolation of photovoltaic systems.

Typical Applications

- Photovoltaic systems
- Inverters
- Solar DC Safety Switches
- Recombiner Boxes

Catalog Numbers (Amps)

PVS-R-20	PVS-R-70	PVS-R-175
PVS-R-25	PVS-R-80	PVS-R-200
PVS-R-30	PVS-R-90	PVS-R-225
PVS-R-35	PVS-R-100	PVS-R-250
PVS-R-40	PVS-R-110	PVS-R-300
PVS-R-50	PVS-R-125	PVS-R-350
PVS-R-60	PVS-R-150	PVS-R-400



Designed to meet the new UL Photovoltaic Fuse Standard

Time-Current Characteristic Curves—Average Melt

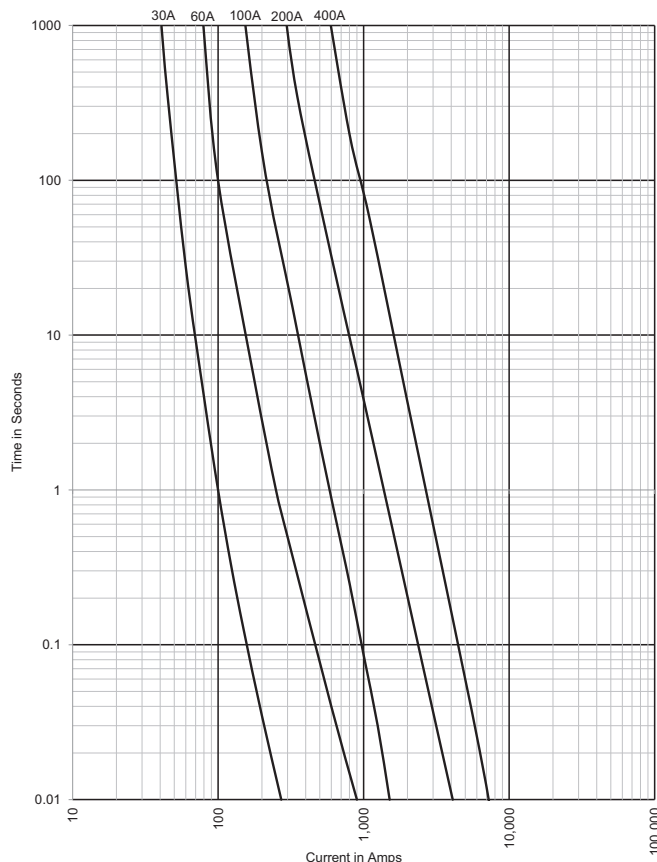

Solar Products

Recommended Fuse Holders & Blocks For Class RK5 Fuses

- See page 19

Data Sheet: 4203

10x38mm Photovoltaic Fuses

PV

Specifications

Class: gPV

Description: A range of fuses specifically designed for the protection and isolation of photovoltaic strings.

Dimensions: 1 1/2" x 1 1/2"
(10.3 x 38.1mm).



Ratings:

Volts — 1000Vdc

Amps — 1-20A

IR — 33kAdc

IR (Min) — 1.3 x I_n

Agency Information: CCC pending, UL Listed E335324, IEC 60269-6, UL 2579, CSA.

Features and Benefits

- Capable of interrupting low over currents associated with faulted PV strings.
- High DC voltage rating.
- Variety of mounting options for flexibility.

Dimensions - mm

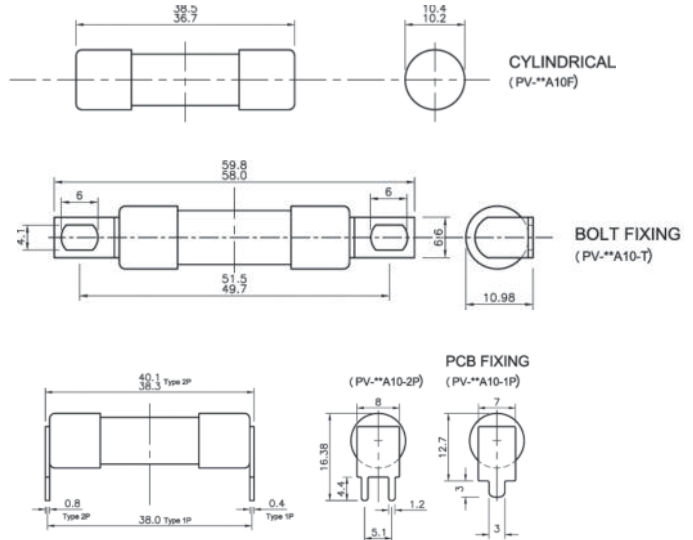

Catalog Numbers (Amps)

Part Number	Current Rating (Amps)	Energy Integrals I ² t (A ² s)		Watts Loss	
		Pre-Arcing	Total at 1000V	0.8 I _n	I _n
PV-1A10F	1	0.15	0.4	0.8	1.5
PV-2A10F	2	1.2	3.4	0.6	1.0
PV-3A10F	3	4	11	0.8	1.3
PV-3-5A10F	3.5	6.6	18	0.9	1.4
PV-4A10F	4	9.5	26	1.0	1.5
PV-5A10F	5	19	50	1.0	1.6
PV-6A10F	6	30	90	1.1	1.8
PV-8A10F	8	3	32	1.2	2.1
PV-10A10F	10	7	70	1.2	2.3
PV-12A10F	12	12	120	1.5	2.7
PV-15A10F	15	22	220	1.7	2.9
PV-20A10F	20	34	350	2.1	3.6

Time-Current Characteristic Curves—Average Melt

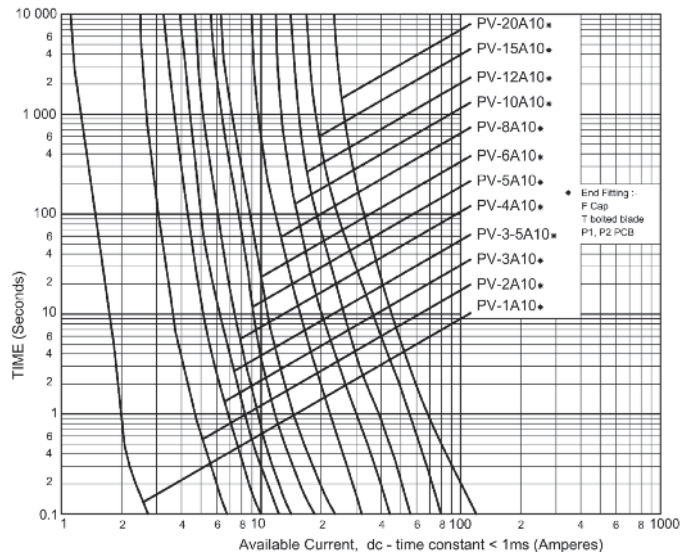

Recommended Fuse Holders & Blocks For Class RK5 Fuses

- See page 19

14x51mm Photovoltaic Fuses

14x51mm

Specifications

Description: A range of 14x51mm package fuse links specifically designed for protecting and isolating photovoltaic strings. These fuse links are capable of interrupting low overcurrents associated with faulted PV systems (reverse current, multi-array fault).

Dimensions: See dimension illustration.

Construction: Melamine tube with silver fuse element.

Ratings:

Rated Volts — 1000Vdc (25 & 32A)
1100Vdc (15 & 20A)

Rated Breaking Capacity: 10kA
Amps — 15-32A

Agency Information: UL Listed, Guide JFGA, File E335324. Photovoltaic to UL 2579, IEC 60269-6 gPV, CSA. CCC pending.

Features and Benefits

- Specifically designed to provide fast-acting protection under low fault current conditions associated with PV systems
- High DC voltage rating
- Demonstrated performance in extreme temperature cycling conditions

Typical Applications

- Photovoltaic systems

Catalog Numbers

Part Number	Current Rating (Amps)	Rated Voltage	Energy Integrals I ² t (A ² s)		Watts Loss	
			Pre-Arcing	Total at Rated Voltage	0.8I _n	I _n
PV-15A14F	15	1100Vdc	14	265	2.1	4
PV-20A14F	20		27	568	2.7	5
PV-25A14F	25	1000Vdc	65	943	2.7	5.1
PV-32A14F	32		120	1740	3.3	6.2



Dimensions - mm

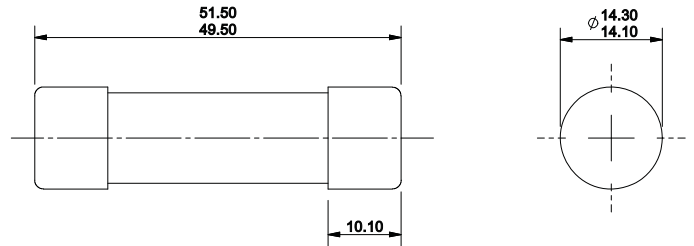

Time-Current Characteristic Curves—Average Melt

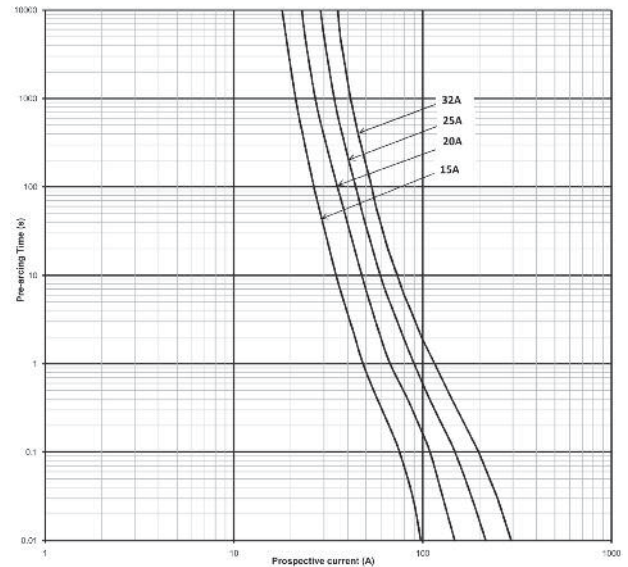

Available Current (Amps), DC-Time Constant 1-3ms

Recommended Fuse Holders & Blocks For Class RK5 Fuses

- See page 19

NH1 Photovoltaic Fuses

Specifications

Description: A range of NH fuse links specifically designed for protecting and isolating photovoltaic array combiners and disconnects. These fuse links are capable of interrupting low overcurrents associated with faulted PV systems (reverse current, multi-array fault).

Dimensions: See dimension illustration.

Construction: Melamine tube with silver fuse element.

Ratings:

Rated Volts — 1000Vdc

Rated Breaking Capacity: 50kA

Amps — 32-160A

Agency Information: UL Listed, Guide JFGA, File E335324. Photovoltaic to UL 2579, IEC 60269-6 gPV, CSA. CCC pending.

Features and Benefits

- Specifically designed to provide fast-acting protection under low fault current conditions associated with PV systems
- High DC voltage rating
- Variety of mounting options for flexibility
- Demonstrated performance in extreme temperature cycling conditions

Typical Applications

- Photovoltaic systems
- Inverters

Catalog Numbers

Part Number	Current Rating (Amps)	Energy Integrals I ² t (A ² s)		Watts Loss	
		Pre-Arcing	Total at 1000V	0.8I _n	I _n
PV-32ANH1	32	80	720	4.3	8.5
PV-40ANH1	40	185	1670	4.6	9
PV-50ANH1	50	400	3600	5.4	10.5
PV-63ANH1	63	470	4300	6.1	12
PV-80ANH1	80	640	5760	7.9	15.5
PV-100ANH1	100	1300	11,700	8.4	16.5
PV-125ANH1	125	2600	23,400	8.9	17.5
PV-160ANH1	160	5200	46,800	12.2	24



Dimensions - mm

Size 1

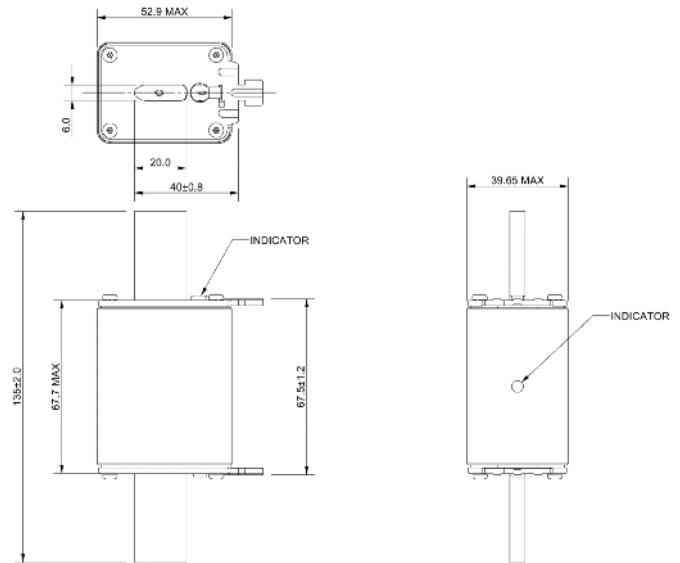

Time-Current Characteristic Curves—Average Melt

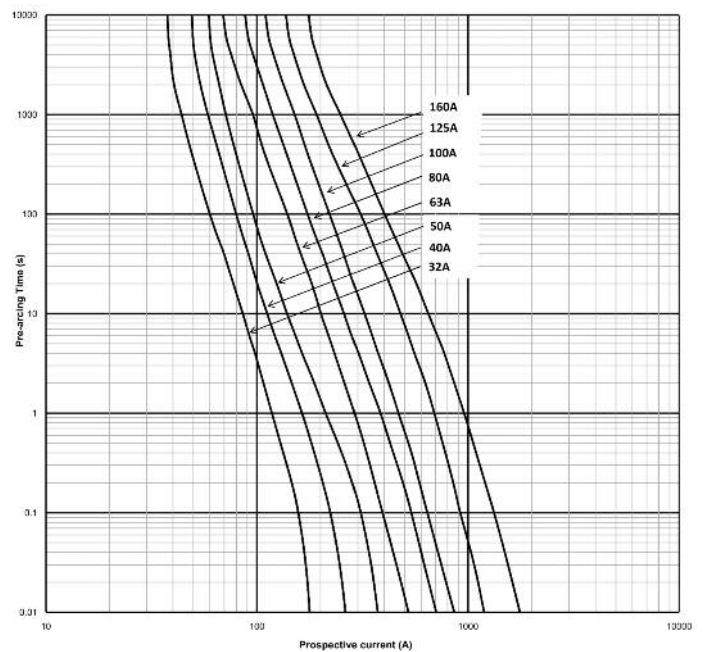

Recommended NH1 Fuse Holders - SD(size)-D

- See page 54

Available Current (Amps), DC-Time Constant 1-3ms

XL Photovoltaic Fuses

1000Vdc XL Style Photovoltaic Fuses



Specifications

Description: A range of XL package fuses specifically designed for protecting and isolating photovoltaic array combiners and disconnects.

These fuse links are capable of interrupting low overcurrents associated with faulted PV systems (reverse current, multi-array fault).

Dimensions: See dimension illustration.

Ratings:

- Volts — 1000Vdc
- Amps — 63 to 630A:
 - IR — 50kA @ 63 to 160A
 - 33kA @ 200 to 315A
 - 50kA @ 350 to 630A

- Agency Information:**
- IEC 60269-6
 - RoHS compliant
 - UL 2579
 - CSA
 - CCC (pending)

Features and Benefits

- Specifically designed to provide fast-acting protection under low fault current conditions associated with PV systems
- High DC voltage rating
- Variety of mounting options for flexibility
- Demonstrated performance in extreme temperature cycling conditions

Typical Applications

- Photovoltaic systems
- Inverters

Recommended Fuse Holders

- SD1XL-S (suitable for 01 and 1XL)
- SD2XL-S (suitable for 2XL)
- SD3L-S (suitable for 3L)



See Data Sheet 720146 for information on the SD__-S Fuse Holders.

Part Number/Style		Body Size	Current Rating (Amps)	Volts	Energy Integrals I ² t (A ² s)		Watts Loss	
Bladed	Bolted				Pre-Arcing	Total @ 1000V	0.8I _n	I _n
PV-63A-01XL	PV-63A-01XL-B	01	63	1000Vdc	350	2520	12	24
PV-80A-01XL	PV-80A-01XL-B		80		660	4752	14	27
PV-100A-01XL	PV-100A-01XL-B		100		1350	9720	15	30
PV-125A-01XL	PV-125A-01XL-B		125		1930	13,896	20	40
PV-160A-01XL	PV-160A-01XL-B		160		3900	28,080	25	44
PV-200A-1XL	PV-200A-1XL-B	1	200	1000Vdc	9400	27,260	31	60
PV-200A-2XL	PV-200A-2XL-B	2	200	1000Vdc	4152	31,000	29	62
PV-250A-2XL	PV-250A-2XL-B		250		7721	57,000	35	70
PV-315A-2XL	PV-315A-2XL-B		315		17,600	130,000	40	75
PV-350A-3L	PV-350A-3L-B	3	350	1000Vdc	30,885	160,700	41	90
PV-400A-3L	PV-400A-3L-B		400		44,000	230,000	63	100
PV-500A-3L	PV-500A-3L-B		500		48,300	251,200	71	138
PV-630A-3L	PV-630A-3L-B		630		100,000	520,000	92	180

Data Sheet: 720134

XL Photovoltaic Fuses for Solar Applications

Dimensions - mm (not to scale)

01XL Blade Size

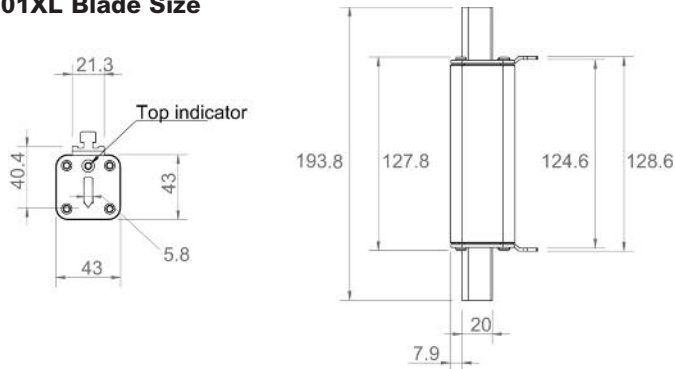

01XL Bolt Size

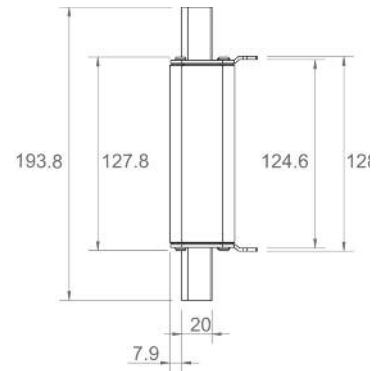

1XL Blade Size

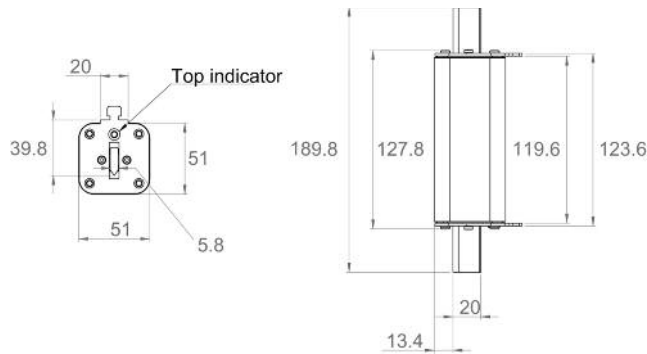

1XL Bolt Size

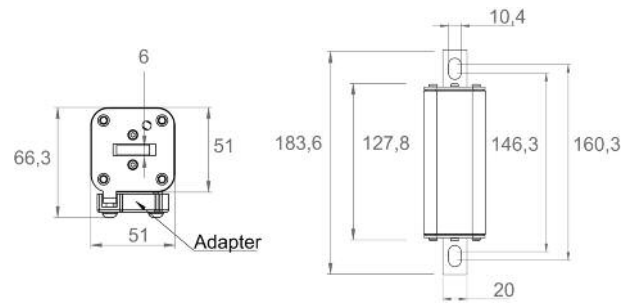

2XL Blade Size

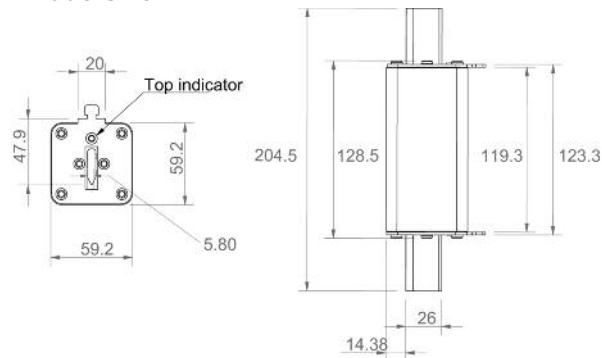

2XL Bolt Size

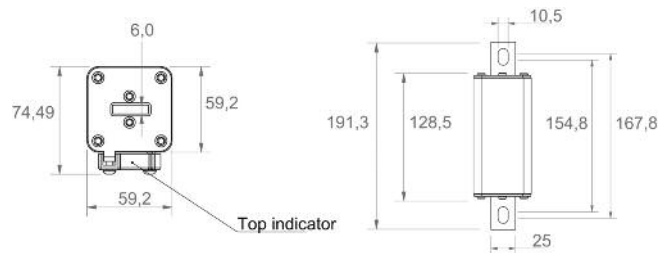

3L Blade Size

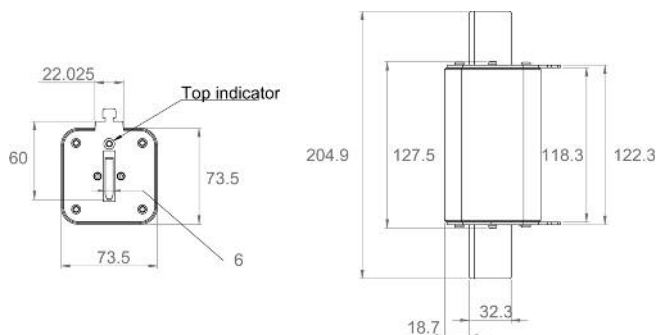

3L Bolt Size

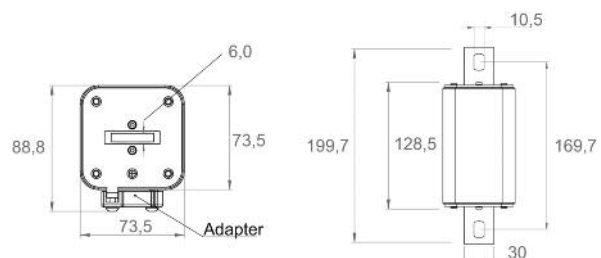

Data Sheet: 720134

XL Photovoltaic Fuses for Solar Applications

Time Current Curves for 01XL and 1XL

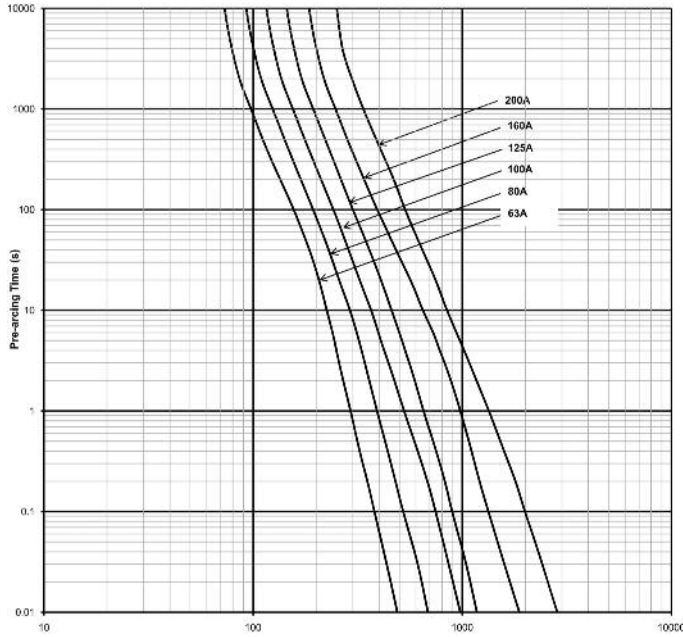

Available Current (Amps), DC-Time Constant 1-3ms

Time Current Curves for 2XL

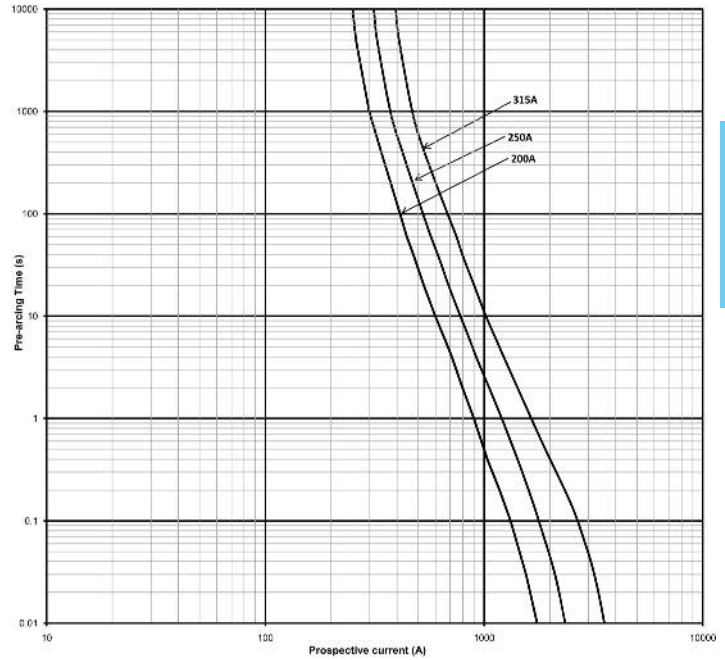

Available Current (Amps), DC-Time Constant 1-3ms

Time Current Curves for 3L

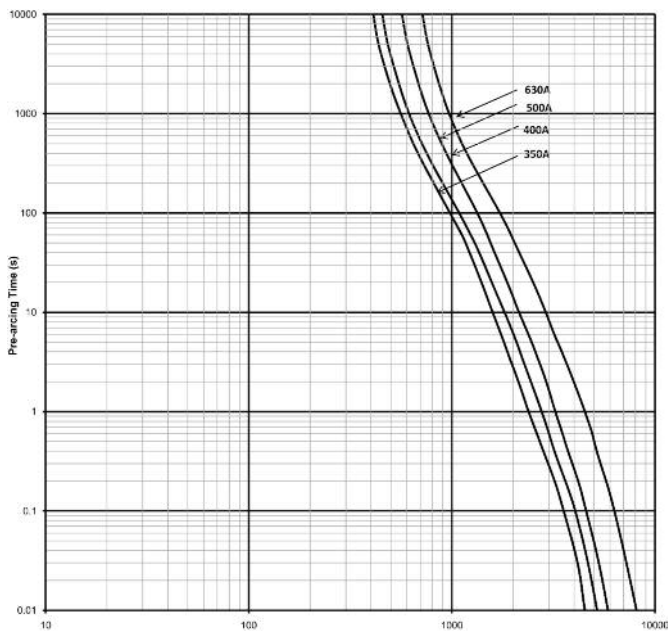

Available Current (Amps), DC-Time Constant 1-3ms

14x65mm Photovoltaic Fuses

Specifications

Description: A range of 14x65mm package fuse links specifically designed for protecting and isolating photovoltaic strings. These fuse links are capable of interrupting low overcurrents associated with faulted PV systems (reverse current, multi-array fault).

Dimensions: See dimension illustration.

Construction: Melamine tube with silver fuse element.

Ratings:

Rated Volts — 1300Vdc (25 & 32A)
1500Vdc (15 & 20A)

Rated Breaking Capacity: 10kA

Amps — 15-32A

Agency Information: UL Listed, Guide JFGA, File E335324. Photovoltaic to UL 2579, IEC 60269-6 gPV, CSA. CCC pending.

Features and Benefits

- Specifically designed to provide fast-acting protection under low fault current conditions associated with PV systems
- High DC voltage rating
- Demonstrated performance in extreme temperature cycling conditions

Typical Applications

- Photovoltaic systems

Catalog Numbers



Dimensions - mm

Cylindrical PV - (amp rating) A14LF

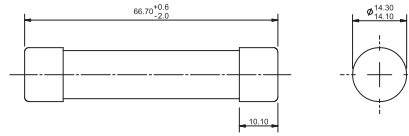

Cylindrical with Tags PV - (amp rating) A14L-T

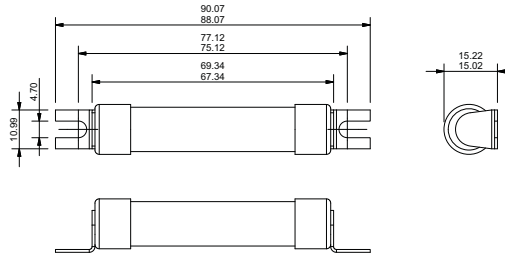

Cylindrical with 10mm Fixings PV - (amp rating) A14LF10F

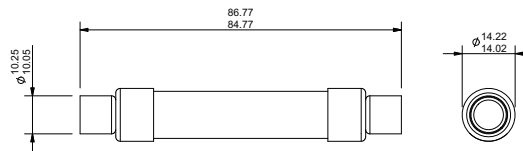

Cylindrical	Part Number		Current Rating (Amps)	Rated Voltage	Energy Integrals I ² t (A ² s)		Watts Loss	
	Cylindrical with Tags	Cylindrical with 10mm Fixings			Pre-Arching	Total at Rated Voltage	0.8 I _n	I _n
PV-15A14LF	PV-15A14L-T	PV-15A14LF10F	15	1500Vdc	14	160	3.2	5.8
PV-20A14LF	PV-20A14L-T	PV-20A14LF10F	20		34	400	3.6	6.5
PV-25A14LF	PV-25A14L-T	PV-25A14LF10F	25	1300Vdc	65	550	4.1	7.5
PV-32A14LF	PV-32A14L-T	PV-32A14LF10F	32		105	900	5.7	10.4

Time-Current Characteristic Curves—Average Melt

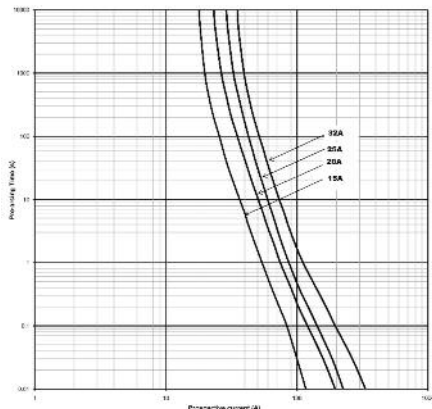

Available Current (Amps), DC-Time Constant 1-3ms

Data Sheet: 720139

XL Photovoltaic Fuses

1500Vdc XL Style Photovoltaic Fuses



Specifications

Description: A range of XL package fuses specifically designed for protecting and isolating photovoltaic array combiners and disconnects.

These fuse links are capable of interrupting low overcurrents associated with faulted PV systems (reverse current, multi-array fault).

Dimensions: See dimension illustration.

Ratings:

- Volts — 1200Vdc (160A)
- 1500Vdc (50-125A, 200-400A)
- Amps — 63 to 400A:
- IR — 33kA

Agency Information: UL Listed, Guide JFGA, File E335324. Photovoltaic to UL 2579, IEC 60269-6 gPV, CSA. CCC pending.

Features and Benefits

- Specifically designed to provide fast-acting protection under low fault current conditions associated with PV systems
- High DC voltage rating
- Variety of mounting options for flexibility
- Demonstrated performance in extreme temperature cycling conditions

Typical Applications

- Photovoltaic systems
- Inverters

Recommended Fuse Holders

- SD1XL-S (suitable for 01 and 1XL)
- SD2XL-S (suitable for 2XL)
- SD3L-S (suitable for 3L)



See Data Sheet 720146 for information on the SD__S Fuse Holders.

Solar Products

Part Number/Style		Body Size	Current Rating (Amps)	Volts	Energy Integrals I ² t (A ² s)		Watts Loss	
Bladed	Bolted				Pre-Arcing	Total @ 1000V	0.8I _n	I _n
PV-50A-01XL-15	PV-50A-01XL-B-15	01	50	1500Vdc	280	1450	6	26
PV-63A-01XL-15	PV-63A-01XL-B-15		63		420	2250	17	28
PV-80A-01XL-15	PV-80A-01XL-B-15		80		950	5000	18	30
PV-100A-01XL-15	PV-100A-01XL-B-15		100		1250	6500	22	38
PV-125A-01XL-15	PV-125A-01XL-B-15		125		2200	11,500	27	48
PV-160A-01XL-12	PV-160A-01XL-B-12		160		5000	19,500	24	48
PV-100A-1XL-15	PV-100A-1XL-B-15	1	100	1500Vdc	1250	6000	24	43
PV-125A-1XL-15	PV-125A-1XL-B-15		125		1950	9360	25	52
PV-160A-1XL-15	PV-160A-1XL-B-15		160		4200	20,160	30	58
PV-200A-1XL-15	PV-200A-1XL-B-15		200		9400	45,120	31	61
PV-125A-2XL-15	PV-125A-2XL-B-15	2	125	1500Vdc	2200	11,000	23	43
PV-160A-2XL-15	PV-160A-2XL-B-15		160		5000	25,000	26	50
PV-200A-2XL-15	PV-200A-2XL-B-15		200		9300	36,000	28	56
PV-250A-2XL-15	PV-250A-2XL-B-15		250		13,700	68,000	38	72
PV-250A-3L-15	PV-250A-3L-B-15	3	250	1500Vdc	20,000	61,000	35	62
PV-315A-3L-15	PV-315A-3L-B-15		315		38,000	116,000	40	72
PV-355A-3L-15	PV-355A-3L-B-15		355		44,000	136,000	46	84
PV-400A-3L-15	PV-400A-3L-B-15		400		58,000	177,000	50	91

Data Sheet: 720134

XL Photovoltaic Fuses

Dimensions - mm

Bladed - Size 01XL, 1XL, 2XL and 3L

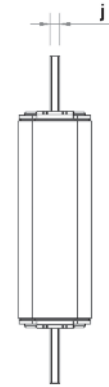
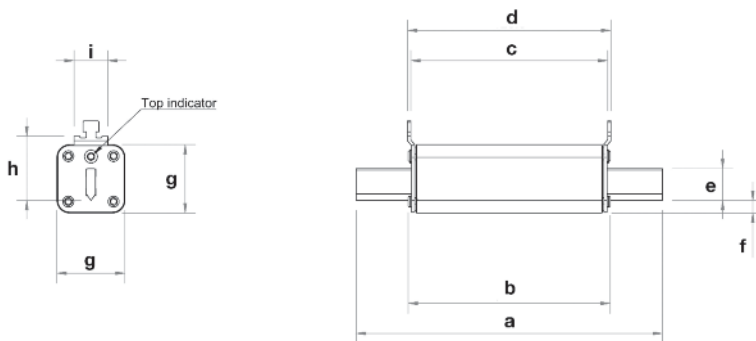

Size	a	b	c	d	e	f	g	h	i	j
01XL	193.8	127.8	124.6	128.6	20	7.9	43	40.4	21.3	5.8
1XL	189.8	127.8	119.6	123.6	20	13.4	51	39.8	20	5.8
2XL	204.5	128.5	119.3	123.3	26	14.38	59.2	47.9	20	5.8
3L	204.9	127.5	118.3	122.3	32.3	18.7	73.5	60	22	6

Bladed - Size 01XL, 1XL, 2XL and 3L

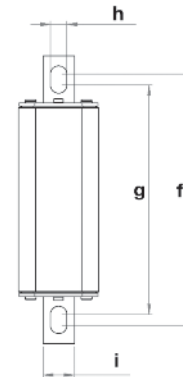
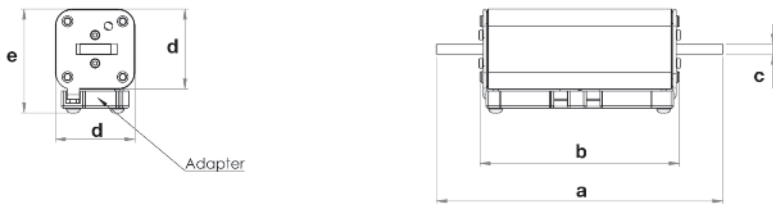

Size	a	b	c	d	e	f	g	h	i
01XL	187.6	127.8	6	43	58.3	164.3	150.3	10.4	20
1XL	183.6	127.8	6	51	66.3	160.3	146.3	10.4	20
2XL	191.3	128.5	6	59.2	74.5	167.8	154.8	10.5	25

Bladed - Size 01XL, 1XL, 2XL and 3L

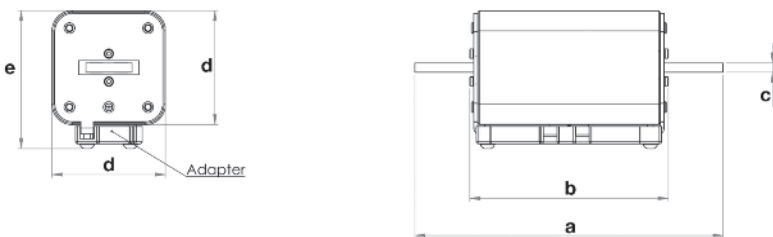

Size	a	b	c	d	e	f	g	h
3L	199.7	128.5	6	73.5	88.8	169.7	10.5	30

XL Photovoltaic Fuses

Time Current Curves for 01XL - 1500Vdc

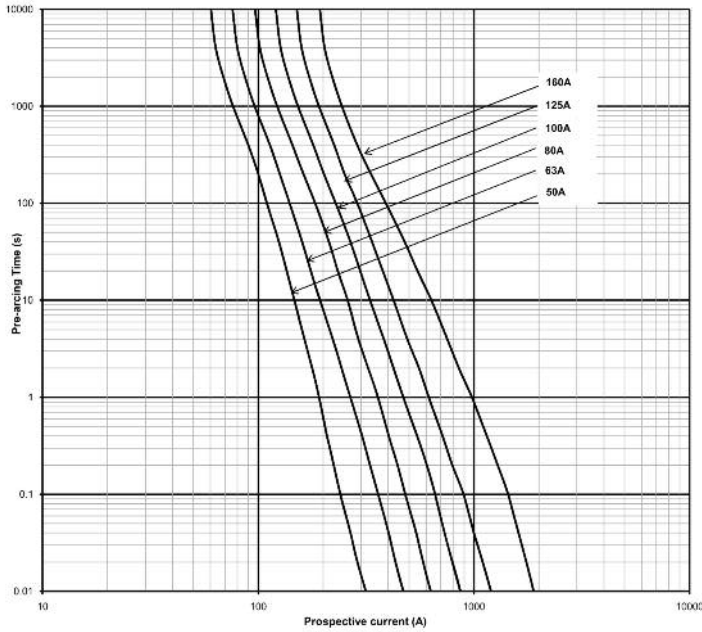

Available Current (Amps), DC-Time Constant 1-3ms

Time Current Curves for 1XL - 1500Vdc

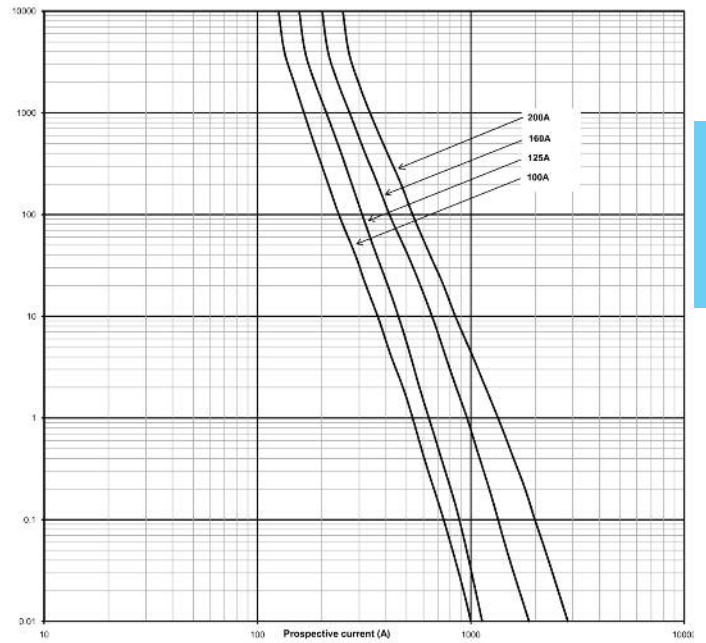

Available Current (Amps), DC-Time Constant 1-3ms

Time Current Curves for 2XL - 1500Vdc

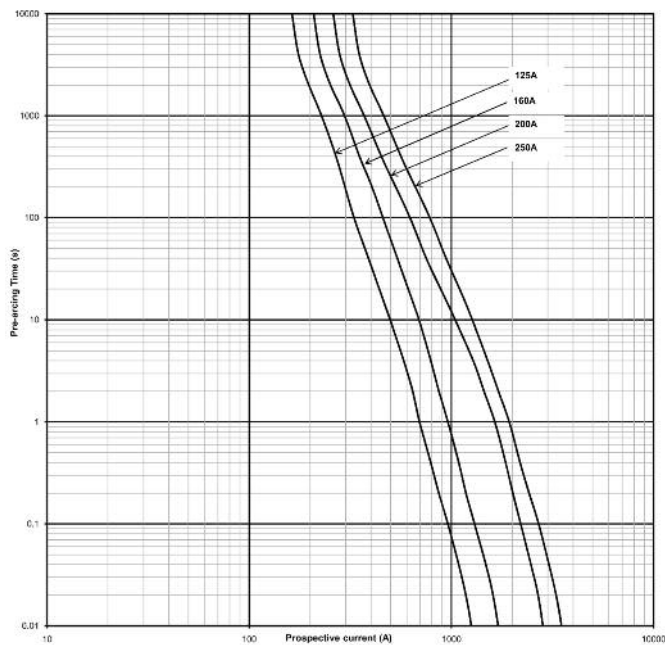

Available Current (Amps), DC-Time Constant 1-3ms

Time Current Curves for 3L - 1500Vdc

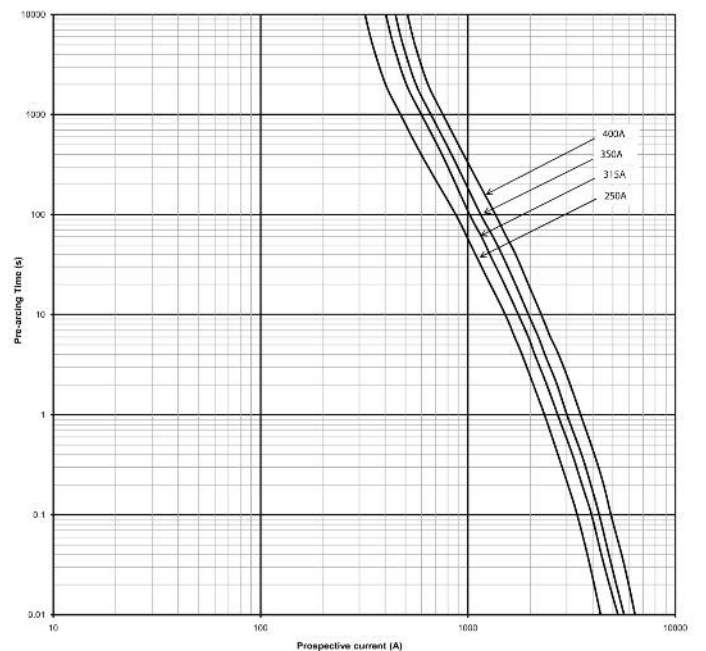

Available Current (Amps), DC-Time Constant 1-3ms

easyID™ fuses and fuse holders

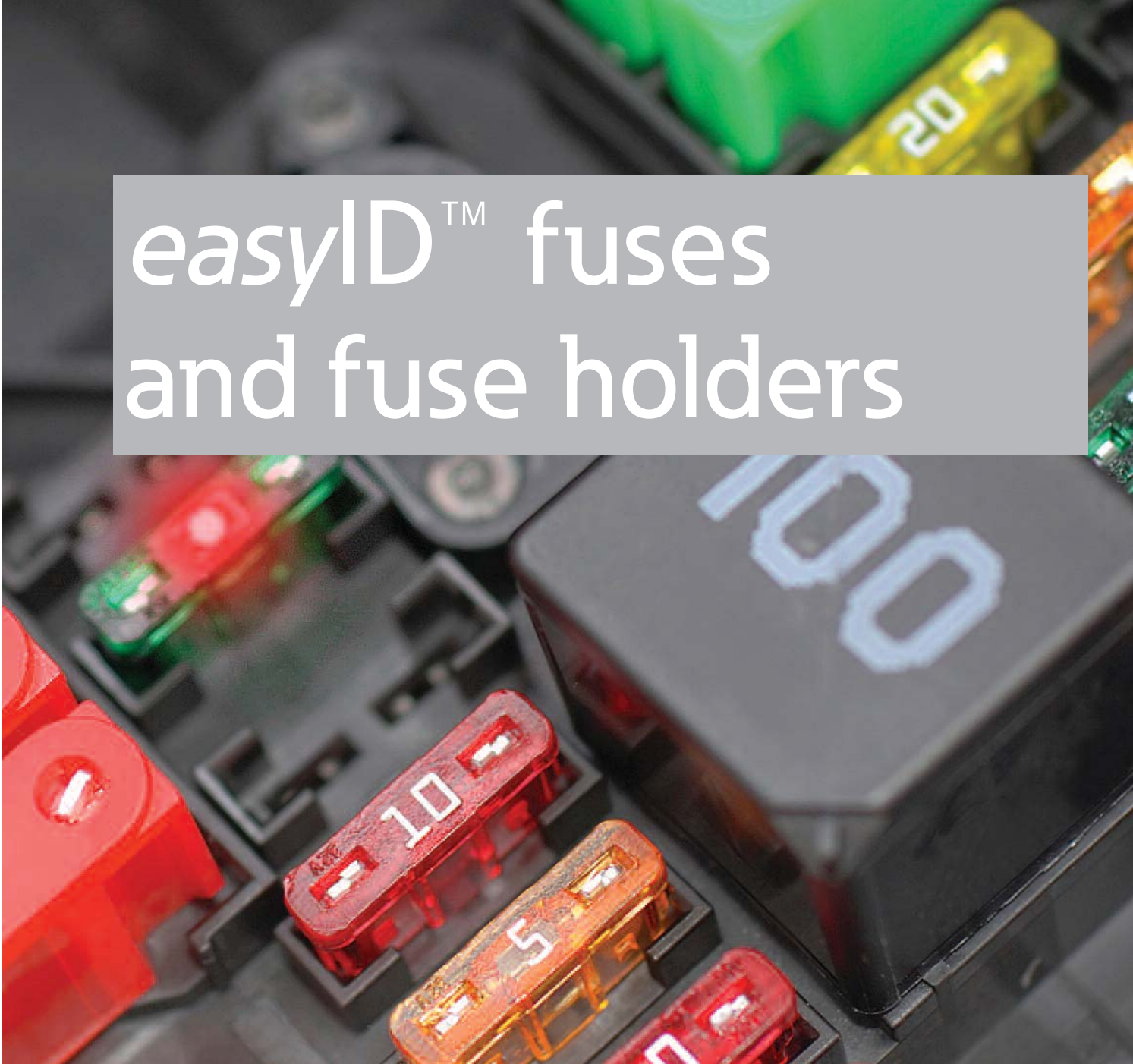

Find blown fuses fast and easy.
Utilize LED technology to
indicate a blown fuse.

Bussmann
by **EAT•N**

Low Voltage Supplementary Fuses

Section Contents

RED indicates NEW information



Page

Fuse Holder & Block Selection Guide	72-73
Cable limiters & welder limiters	
K Series cable limiters 600V	74
64000 & 68000 welder limiters . . . 600V	74
$1\frac{3}{32}$" x 1 $\frac{1}{2}$" Fast-acting supplementary fuses	
BAF 250V	75
KTK 600V	75
KLM 600Vac/dc	75
$1\frac{3}{32}$" x 1 $\frac{1}{2}$" Time-delay supplementary fuses	
FNM 250V	76
FNQ 500V	76
$1\frac{3}{32}$" x 1 $\frac{3}{8}$" Fast-acting supplementary fuses	
BBS 600V	77
Pin indication fuses and actuator	
GBA 125V	78
GLD 125V	78
MIC 250V fast-acting	78
MIN 250V fast-acting	78
FNA 250V time-delay	78
MIS 600V	79
KAZ 600V	79
Limiters	
ANN 125V fast-acting	79
ANL 80Vdc time-delay	79
4164 & 4164-FR fuse blocks	79
In-line size rejecting fuses and fuse holders	
GLQ 300V	80
GMQ 300V	80
In-line non-rejecting fuses and fuse holders	
GLR 300V	81
GMF 300V	81
GRF 300V	81
Automotive blade-type fuses	
ATC 32Vdc	82
ATC_ID 32Vdc	82
ATM 32Vdc	82
ATM_ID 32Vdc	82
ATM-LP 32Vdc	82
MAX 32Vdc	83
MAX_ID 32Vdc	83
Automotive blade-type fuse holders	
HHC, HHD, HHF, HHG, ATC-FHID for ATC fuses	82
HHL, HHM, ATC-FHID for ATM fuses	83
HXX for MAX fuses	83
PCB fuseclips for ATC/ATM blade, 5mm, $\frac{1}{4}$ " & $\frac{1}{2}$ " diameter fuses	84

Low Voltage Supplementary Fuses

Holders & Blocks for Low Voltage Supplementary Fuses

Limiters

Catalog Number	Volts	Page
K Series	600V	74
68000 Series	600V	74
64000 Series	600V	74
ANN Fast acting limiter	125Vac/80Vdc	79
ANL Time-delay limiter	80Vdc	79

Holders

- CH Series Class J modular 1 to 3-pole, panel/DIN rail mount283
- Safety J™ Series modular holders, panel/DIN rail mount288

Blocks

- Modular Type Fuse Blocks 250/600V, panel mount311
- H250 Series 1- to 3-pole 250V, panel mount296
- H600 Series 1- to 3-pole 600V, panel mount299

Blocks

- Modular Knifeblade Fuse Blocks 250/600V, panel mount291
- Modular Type Fuse Blocks 600V, panel mount311
- J600 Series, panel mount302
- JP Series pyramid blocks, panel mount304
- BH Series modular-style open blocks, panel mount311

Limiter Blocks - ANN & ANL

- Blocks for 4164 & 4164-FR79



1 1/2" X 1 1/2" Fuses

Catalog Number	Volts	Page
BAF	250V	75
KTK	600V	75
KLM	600Vac/dc	75
FNM	250V	76
FNQ	500V	76

Holders

- OPM-NG-SC3 3-pole, panel/DIN-Rail mount286
- OPM-1038R 3-pole, panel/DIN-Rail mount285
- OPM-1038RSW 3-pole w/ switch, panel/DIN-Rail mount284
- CH Series Global 1- to 3-pole, DIN-Rail mount276
- HPG Panel mount fuse holder322
- HPC-D Panel mount fuse holder323
- HPM Panel mount fuse holder323
- HPS Series Panel mount fuse holder322
- HPF Series Panel mount fuse holder322
- HEB Series 1-Pole in-line fuse holder315
- HEX & HEY Series 2-Pole in-line fuse holders315
- NDNF1-WH Fuse holding rail mount terminal block327

Blocks

- BM Series, panel/DIN-Rail with adapters310
- 3723, 3742 and 3743 multi-pole add-on fuse blocks326



Holders & Blocks for Low Voltage Supplementary Fuses

1 3/32" X 1 3/8" Fuses

Catalog Numbers	Volts	Page
BBS	600V	77

Holder

- HPS-L Panel mount holder322

Blocks

- BM Series, panel/DIN rail with adapters310
- 3723, 3742 and 3743 multi-pole add-on fuse blocks326



HPS-L



BM Series

Pin Indicating Fuses

1/4" X 1 1/4" Fuse Catalog Numbers	Volts	Page
GBA 1/4" X 1 1/4"	125V	78
GLD 1/4" X 1 1/4"	125V	78
MIC 1 3/32" X 1 1/2"	250V	78
MIN 1 3/32" X 1 1/2"	250V	78
FNA 1 3/32" X 1 1/2"	250V	78
MIS 1 3/32" X 2"	600V	79
KAZ 1 3/32" X 2"	600V	79



HLD



HK Series

Holders

- 1/4" X 1 1/4": HLD Panel mount visual indication321
- 1/4" X 1 1/4": HK Series Panel mount lamp indicating321

Blocks

- 1/4" X 1 1/4": Series 8000 for visual indication324
- 1 3/32" X 1 1/2": 1-Pole signal block cat. # 3839 (not shown in catalog)*
- 1 3/32" X 2": 1-Pole signal block cat. # 2778 (not shown in catalog)*
- 1 3/32" X 2": 2-Pole signal block cat. # 2837 (not shown in catalog)*
- 1 3/32" X 2": 3-Pole signal block cat. # 2838 (not shown in catalog)*

*Call our customer satisfaction team at 636-527-3877 for more information.



Series 8000

Automotive Blade-type Fuses

Catalog Numbers	Volts	Page
ATC	32Vdc	82
ATM	32Vdc	82
MAX	32Vdc	83

Holders

- ATC: HHC, HHD, HHF, HHG & ATC-FHID In-line holders 82
- ATM: HHL, HHM & ATM-FHID In-line holders 83
- MAX: HHX In-line holders 83



easyID™
Illuminating Holders



HHC, HHD, HHF
& HHG



HHL & HHM



HHX

In-Line Rejecting and Non-Rejecting Fuses

Catalog Number	Volts	Page
GLQ rejecting fuse	300V	80
GMQ rejecting fuse	300V	80
GLR non-rejecting fuse	300V	81
GMF non-rejecting fuse	300V	81
GRF non-rejecting fuse	300V	81

Holders

- GLQ & GMQ: HLQ Rejection holder 80
- GLR, GMF & GRF: HLR & HLR-2A non-rejection holders81



HLQ³ Fuse Holders



HLR Fuse Holder

Low Voltage Supplementary Fuses

Cable Limiters & Welder Limiters

K Series

Specifications

Description: Cable limiters.

Ratings:

- Volts — 600Vac
- IR — 200kA RMS Sym. @ 600Vac

Agency Information: UL

Listing: KDM, KDR, KDP and KFM, KCM, KCM-B and KCR.

Features and Benefits

- Sizes and ratings available to meet many applications.

Typical Applications

- Protecting low voltage distribution and service entrance cables against short-circuit currents.

Catalog Numbers

Copper Cable Limiter — 600 Volts

Catalog Number	Cable Size	Catalog Number	Cable Size
----------------	------------	----------------	------------

Tubular Terminals

KCY	#4	KCF	4/0
KCZ	#3	KCH	250 MCM
KCA	#2	KCJ ^{1,2}	350 MCM
KCB	#1	KCM ^{1,2,3} , KCM-B ¹	500 MCM
KCC	1/0	KCV	600 MCM
KCD ^{1,2}	2/0	KCR ^{1,2}	750 MCM
KCE	3/0	KCS	1000 MCM

Tubular Terminal and Offset Bolt-Type Terminal

KQV	#12	KDD ¹	2/0
KQT	#10	KDE	3/0
KFZ	#8	KDF	4/0
KIG	#6	KDH	250 MCM
KDY	#4	KDJ ^{1,2}	350 MCM
KDA	#2	KDM ^{1,2,3}	500 MCM
KDB	#1	KDU	600 MCM
KDC	1/0	KDR ^{1,2}	750 MCM

Compression Connector Rod and Tubular Terminals

KEX	4/0	KQO	350 MCM
KFH-A	250 MCM	KDT ¹	500 MCM

*Center Bolt-Type Terminal and Off-Set Bolt-Type Terminal

KPF	4/0	KDP ¹	500 MCM
KFT ¹	250 MCM	KFM ¹	750 MCM
KEW ¹	350 MCM		

¹Copper or aluminum cable; sizes of all other limiters pertain to copper only. KFM copper only. ¹UL Listed (File E90818).

²Available with shrink tube “_V” suffix.

³Available with molded rubber boots. Add “-B” to end of part number.

Accessories

Boots can be purchased separately.

For KCM BOOT-KCM

For KDM BOOT-KDM

Installation tools can be purchased separately from Thomas and Betts

• Crimp Tool: TBM-14M

• Die: 15506 KDM/15515 KDR

64000 & 68000 Series

Specifications

Description: Welder limiters.

Ratings:

- Volts — 600Vac (or less)
- IR — 200kA RMS Sym.

Features and Benefits

- Current-limiting devices designed specially for use on welder circuits only
- Time-current characteristics are designed to hold on the intermittent overloading encountered in welder operation, while providing short-circuit protection to the circuit and equipment
- Welder limiters have excess current capacity in the operating range as needed for this type of service

Typical Applications

- Welder circuits
- Because welder limiters have special characteristics, they are not intended for application on general-use circuits

Catalog Numbers

Catalog Numbers	Fuse Holder Type	Nominal Amp Rating
68300	Class H	300
68600	Class H	600
64200	Class J	200
64300	Class J	300



Recommended Fuse Blocks For 68000 & 64000 Series limiters

- See page 72

Data Sheet: 1045

Data Sheet: 1042

1 3/32" x 1 1/2" Fast-acting Fuses

BAF

Specifications

Class: Supplemental

Description: Fast-acting supplementary fuse.

Dimensions: 1 3/32" x 1 1/2" (10.3 x 38.1mm).

Ratings:

Volts — 250Vac (or less)

Amps — 3/10-30A

IR — 10kA @ 125Vac (3/10-30A)

— 35A (3/10-1A @ 250Vac)

— 100A (1 1/2-3A @ 250Vac)

— 200A (4-10A @ 250Vac)

— 750A (12A- 15A @ 250Vac)

— 200A (20-30A @ 250Vac)

Agency Information: CE, Std. 248-14, UL 0-15/250V, Guide JDYX, File E19180 CSA Certified, 0-15/250V, Class 1422-01, File 53787.

Features and Benefits

- Low cost supplemental protection of 125V and 250V non-inductive circuits.
- Upgrade with LP-CC product to reduce SKU investment and minimize potential arc-flash hazards. (and minimize potential for misapplying fuse.)

Typical Applications

- General Purpose Circuits
- Lighting Circuit Protection
- Meter Circuits

Catalog Numbers (Amps)

BAF-3/4	BAF-2-3/4	BAF-9
BAF-1/2	BAF-3	BAF-10
BAF-3/10	BAF-4	BAF-12
BAF-3/10	BAF-5	BAF-15
BAF-1	BAF-6	BAF-20
BAF-1-1/2	BAF-6-3/4	BAF-25
BAF-1-3/10	BAF-7	BAF-30
BAF-2	BAF-8	

*All have interrupting rating of 10,000A at 125V.

For superior electrical protection, Bussmann recommends upgrading BAF and fuse applications to Low-Peak LP-CC fuses See page 23.

Data Sheet: 2011 (0-30)



KTK

Specifications

Class: Supplemental

Description: Fast-acting supplementary fuse.

Dimensions: 1 3/32" x 1 1/2" (10.3 x 38.1mm).

Ratings:

Volts — 600Vac (or less)

Amps — 3/10-30A

IR — 100kA RMS Sym. (UL)

Agency Information: CE, Std. 248-14, UL Listed, Guide JDYX, File E19180.

Features and Benefits

- Low cost supplemental protection of 600V or less non-inductive circuits.
- Upgrade with LP-CC product to reduce SKU investment and minimize potential arc flash hazards.

Typical Applications

- Control Circuits
- Lighting Circuit Protection
- Meter Circuits

Catalog Numbers (Amps)

600Vac - UL Listed and CSA				
KTK-3/10	KTK-3/4	KTK-4	KTK-12	KTK-50*
KTK-3/10	KTK-1	KTK-5	KTK-15	
KTK-3/10	KTK-1-1/4	KTK-6	KTK-20	
KTK-3/4	KTK-1-1/2	KTK-7	KTK-25	
KTK-3/10	KTK-2	KTK-7-1/2	KTK-30	
KTK-3/10	KTK-2-1/2	KTK-8	KTK-35*	
KTK-1/2	KTK-3	KTK-9	KTK-40*	
KTK-3/10	KTK-3-1/2	KTK-10	KTK-45*	

*Rated for no more than 24A continuous.

For superior electrical protection, Bussmann recommends upgrading KTK fuse applications to Low-Peak LP-CC fuses See page 23.

Data Sheet: 1011



KLM

Specifications

Class: Supplemental

Description: Full range, fast-acting, DC midget fuse.

Dimensions: 1 3/32" x 1 1/2" (10.3 X 38.1mm).

Ratings:

Volts — 600Vac/dc

Amps — 3/10-30A

IR — 100kA AC

— 50kA DC

Agency Information: CE, UL Listed: STD. 248-14, (FILE #E19180), CSA Certified, C22.2 NO. 248. 14 (CLASS #1422-01, FILE #53787).

Features and Benefits

- Full range, fast-acting, 600Vac/dc midget fuse.
- Minimum interrupting rating or 200% rated current at 600Vdc.

Typical Applications

- DC Control Circuits Requiring Fast-Acting Fuses.
- Solar power energy sources - use the Bussmann PVM fuse for DC ratings up to 600Vdc.

Catalog Numbers (Amps) - KLM

KLM-3/10	KLM-3/4	KLM-5	KLM-20
KLM-3/10	KLM-1	KLM-6	KLM-25
KLM-3/10	KLM-1-1/2	KLM-8	KLM-30
KLM-3/4	KLM-2	KLM-10	
KLM-3/10	KLM-3	KLM-12	
KLM-1/2	KLM-4	KLM-15	



Recommended fuse blocks/fuse holders for 1 3/32" x 1 1/2" fuses

- See page 72

1³/₃₂" x 1 1¹/₂" Time-delay Fuses

FNM

Specifications

Class: Supplemental

Description: Time-delay supplementary fuse.

Dimensions: 1³/₃₂" x 1 1¹/₂" (10.3 x 38.1mm).

Ratings:

Volts — 250Vac (or less)

Amps — 1/10-30A

IR — 35A (1/10-1A @ 250Vac)

— 100A (1 1/8-3 1/2A @ 250Vac)

— 200A (4-10A @ 250Vac)

— 10kA (1/10-10A @ 125Vac)

— 10kA (12-30A @ 250Vac)

Agency Information: CE, Std. 248-14, UL Listed, 0-30/250Vac; File E19180, Guide JDYX, CSA Certified, 1-30/250Vac; Class 1422-01, File 53787.

Features and Benefits

- Low cost supplemental protection of 125V and 250V inductive circuits.

Typical Applications

- General Purpose Circuits
- Lighting Circuit Protection
- Meter Circuits
- Upgrading to LP-CC product will reduce SKU investment and minimize potential for misapplying fuse

Catalog Numbers (Amps)

FNM-1/10	FNM-1/2	FNM-1-1/2	FNM-3	FNM-6	FNM-15
FNM-1/8	FNM-9/10	FNM-1-9/10	FNM-3-3/10	FNM-6-1/4	FNM-20
FNM-15/100	FNM-3/4	FNM-1-1/10	FNM-3-1/2	FNM-7	FNM-25
FNM-1/10	FNM-1	FNM-2	FNM-4	FNM-8	FNM-30
FNM-1/4	FNM-1-1/2	FNM-2-1/4	FNM-4-1/2	FNM-9	
FNM-3/10	FNM-1-1/4	FNM-2-1/2	FNM-5	FNM-10	
FNM-1/10	FNM-1-3/10	FNM-2-9/10	FNM-5-9/10	FNM-12	



FNQ

Specifications

Class: Supplemental

Description: Time-delay supplementary fuse.

Dimensions: 1³/₃₂" x 1 1¹/₂" (10.3 x 38.1mm).

Ratings:

Volts — 500Vac (or less)

Amps — 1/10-30A

IR — 10kA RMS Sym.

Agency Information: CE, Std. 248-14, UL Listed, Guide JDYX, File E19180 CSA Certified, Class 1422-01, File 53787.

Features and Benefits

- Low cost supplemental protection of transformers and relays at 500V or less.

Typical Applications

- Control Transformer 480V Primary Protection
- Lighting Circuit Protection
- Meter Circuits

Catalog Numbers (Amps)

FNQ-1/10	FNQ-1/8	FNQ-1-1/2	FNQ-3-1/2	FNQ-7	FNQ-20
FNQ-1/8	FNQ-1/2	FNQ-1-9/10	FNQ-4	FNQ-8	FNQ-25
FNQ-15/100	FNQ-9/10	FNQ-2	FNQ-4-1/2	FNQ-9	FNQ-30
FNQ-3/10	FNQ-3/4	FNQ-2-1/4	FNQ-5	FNQ-10	
FNQ-1/10	FNQ-1	FNQ-2-1/2	FNQ-5-9/10	FNQ-12	
FNQ-1/4	FNQ-1-1/2	FNQ-3	FNQ-6	FNQ-14	
FNQ-1/10	FNQ-1-1/4	FNQ-3-3/10	FNQ-6-1/4	FNQ-15	



For superior electrical protection, Bussmann recommends upgrading FNM and FNQ fuse applications to Low-Peak LP-CC fuses See page 23.

Recommended fuse blocks and fuse holders for

1³/₃₂" x 1 1¹/₂" fuses

- See page 72

Data Sheet: 2028

For superior electrical protection, Bussmann recommends upgrading FNM and FNQ fuse applications to Low-Peak LP-CC fuses See page 23.

Recommended fuse blocks and fuse holders for

1³/₃₂" x 1 1¹/₂" fuses

- See page 72

Data Sheet: 1012

1 $\frac{3}{32}$ " x 1 $\frac{3}{8}$ " Fast-acting Fuses

BBS

Specifications

Class: Supplemental

Description: Fast-acting supplementary fuse.

Dimensions: 1 $\frac{3}{32}$ " x 1 $\frac{3}{8}$ "
(10.3 x 34.9mm).

Construction: Fiber cartridge.

Ratings:

Volts — 600Vac ($\frac{1}{10}$ -5A)
— 250Vac (6 - 10A)
— 48Vac (12-30A)

Amps — $\frac{1}{10}$ -30A

IR — 10kA RMS Sym.

Agency Information: CE, Std. 248-14, UL Listed, 0-5A/600V, Guide JDYX, File E19180, CSA Certified, 0-5A/600V, Class 1422-01, File 53787.

Features and Benefits

- Low cost supplemental protection of non-inductive circuits
- Reduced interchangeability with other supplemental fuses minimizes misapplication

Typical Applications

- Control Circuits
- Lighting Ballasts
- Meter Circuits

Catalog Numbers (Amps)

BBS- $\frac{1}{10}$	BBS- $\frac{3}{10}$	BBS-4	BBS-15
BBS- $\frac{2}{10}$	BBS-1	BBS-5	BBS-20
BBS- $\frac{1}{4}$	BBS-1- $\frac{1}{2}$	BBS-6	BBS-25
BBS- $\frac{3}{10}$	BBS-1- $\frac{3}{10}$	BBS-7	BBS-30
BBS- $\frac{1}{2}$	BBS-1- $\frac{3}{10}$	BBS-8	
BBS- $\frac{6}{10}$	BBS-2	BBS-10	
BBS- $\frac{3}{4}$	BBS-3	BBS-12	



Recommended fuse blocks/fuse holders for 1 $\frac{3}{32}$ " x 1 $\frac{3}{8}$ " fuses

- Page 73

Data Sheet: 2010 (0-30A)

Pin Indication Fuses

GBA

GLD

Specifications

Class: Supplemental

Description: Fast-acting, pin indication fuse.

Dimensions: ¼" x 1 ¼"
(6.6 x 31.7mm) 3AG.

Ratings:

Volts — See Agency Info below

Amps — ½-15A

IR — See Agency Info below

Agency Information: CE, Std. 248-14, UL Listed, 0-5A/125Vac, 10,000 AIC, Guide JDYX, File E19180, UL Recognized, 6A/125Vac, 1000AIC 8-15A/50Vac/dc, 300 AIC Guide JDYX2, File E19180, CSA Certified: 0-5A/125Vac, 10,000 AIC Class 1422-01, File 53787.

Features and Benefits

- Type GBA has a "red" pin indicator providing visual identification of failed circuits, resulting in faster troubleshooting (reduced circuit downtime).
- Type GLD has a plated pin to activate transmitting a electrical signal to indicate the location of opened circuits, resulting in reduced downtime.

Typical Applications

- Control Circuits
- Electronic Circuits

GLD Catalog Numbers (Amps)

GLD-½	GLD-2	GLD-6
GLD-¾	GLD-3	GLD-10
GLD-1	GLD-4	GLD-12
GLD-1-½	GLD-5	GLD-15

GBA Catalog Numbers (Amps)

GBA-½	GBA-2	GBA-8
GBA-¾	GBA-3	GBA-10
GBA-1	GBA-4	GBA-15
GBA-1-½	GBA-5	

Recommended fuse blocks/fuse holders for ¼" x 1 ¼" indicating fuses

- Page 73

Data Sheet: 2012

MIC & MIN

Specifications

Class: Supplemental

Description: Fast-acting, pin indication fuse.

Dimensions: 1 3/32" x 1 ½"
(10.3 x 38.1mm) 5AG.

Ratings:

Volts — 250Vac
(1-15A)
— 32Vac (20-30A)

Amps — 1-30A
IR — 35A (1A @250Vac)
— 100A (2-3A @250Vac)
— 200A (5-10A @250Vac)
— 750A (15A @250Vac)
— 10kA (20-30A @32V)
— 35A (1A @250Vac)

Agency Information: CE, Std. 248-14, MIC—0-15A UL Listed, 125Vac/10kA IR Guide JDYX, File E19180, MIN—1-5A CSA Certified, Class 1422-01, File 53787.

Features and Benefits

- Type MIN has a "red" pin indicator providing visual identification of failed circuits, resulting in faster trouble shooting (reduced circuit downtime).
- Type MIC has silver-plated pin transmitting an electrical signal indicating location of a failed circuit, resulting in faster troubleshooting (reduced circuit downtime).

Typical Applications

- Control Circuits
- PLC Circuits
- Electronic Circuits

MIC Catalog Numbers (Amps)

MIC-1	MIC-5	MIC-20
MIC-2	MIC-10	MIC-25
MIC-3	MIC-15	MIC-30

MIN Catalog Numbers (Amps)

MIN-1	MIN-5	MIN-20
MIN-2	MIN-10	MIN-25
MIN-3	MIN-15	MIN-30

Recommended signal block for 1 3/32" x 1 ½" indicating fuses

- Page 73

Data Sheet: 2047

FNA

Specifications

Class: Supplemental

Description: Time-delay, pin indication fuse.

Dimensions: 1 3/32" x 1 ½"
(10.3 x 38.1mm).

Ratings:

Volts — 250Vac (½-¾A)
— 125Vac (1-15A)
— 32Vac (20-30A)

Amps — ½-30A

IR — 35A (½-¾A @ 250Vac)
— 10kA (½-15A @ 125Vac)
— 1kA (20-30A @ 32V)

Agency Information: CE, Std. 248-14, UL Listed ½-¾A, IR 35A@ 250V, IR 10kA@ 125V, 1-15A, IR 10kA@ 125V, Guide JDYX, File 19180, CSA Certified, 0-¾A/250V, 1-10A/125V, Class 1422-01, File 53787.

Features and Benefits

- FNA has a pin indicator providing visual identification of failed circuits, resulting in reduced circuit downtime.
- Time-delay response allows close sizing on control transformers and relays

Typical Applications

- Control Circuits
- Electronic Circuits

Catalog Numbers (Amps)

FNA-½A	FNA-¾A	FNA-2-½	FNA-6-¼
FNA-½	FNA-1	FNA-2-¾	FNA-7
FNA-1-1/100	FNA-1-½	FNA-3	FNA-8
FNA-¾	FNA-1-¼	FNA-3-¾	FNA-9
FNA-¼	FNA-1-¼	FNA-3-½	FNA-10
FNA-¾	FNA-1-½	FNA-4	FNA-12*
FNA-¾	FNA-1-¾	FNA-4-½	FNA-15*
FNA-½	FNA-1-¾	FNA-5	FNA-20*
FNA-¾	FNA-2	FNA-5-¾	FNA-25*
FNA-¾	FNA-2-¼	FNA-6	FNA-30

*12-30A versions are dual-tube construction

Recommended signal block for

1 3/32" x 1 ½" indicating fuses

- Page 73

Data Sheet: 2029



Pin Indication Fuse and Actuator, and Limiters

ANN & ANL Limiters

Specifications
Description: Circuit limiters.
ANN: Very fast-acting limiter.
ANL: Non-time delay limiter.
Dimensions: 7/8" x 3 3/16"
 (22.2 x 81.0mm).

Ratings:
ANN:
 Volts — 125Vac
 — 80Vdc
 Amps — 10-800A
 IR — 2500A @ 125Vac
 — 2700A @ 80Vdc

ANL:
 Volts — 80Vdc
 Amps — 35-750A
 IR — 2700A @ 80Vdc

Agency Information:
ANN: 35-400A @ 125Vac, IR=2500A and 500A @ 80Vdc, IR=2700A: UL Recognized Guide JFHR2, File E56412; CSA Certified Class 1422-30, File 53787, CE for 35-400A.
ANL: UL Recognized, CSA Certified, 35-750A @ 80Vdc, IR = 2700A, Guide JFHR2, File E56412, Class 1422-30, File 53787, SAE J1171.

Features and Benefits

- Fast-acting circuit protection (ANN).
- Time-delay sizing for inductive circuits (ANL).
- Window shows limiter status.

Typical Applications

- Fork lifts, Marine, Aviation



ANN Catalog Numbers (Amps)

ANN-10	ANN-90	ANN-225	ANN-400
ANN-35	ANN-100	ANN-250	ANN-500
ANN-40	ANN-125	ANN-275	ANN-600
ANN-50	ANN-150	ANN-300	ANN-700
ANN-60	ANN-175	ANN-325	ANN-800
ANN-80	ANN-200	ANN-350	

ANL Catalog Numbers (Amps)

ANL-35	ANL-125	ANL-250	ANL-500
ANL-40	ANL-130	ANL-275	ANL-600
ANL-50	ANL-150	ANL-300	ANL-675
ANL-60	ANL-175	ANL-325	ANL-750
ANL-80	ANL-200	ANL-350	
ANL-100	ANL-225	ANL-400	

MIS

Specifications
Class: Supplemental
Description: Non time-delay pin indication fuse.
Dimensions: 1/2" x 2"
 (10.3 x 50.8mm).

Ratings:
 Volts — 600Vac
 Amps — 1-12A
 IR — 200kA

Features and Benefits

- Type MIS has a pin indicator providing visual identification of failed circuits, resulting in faster troubleshooting (reduced circuit downtime).
- Type MIS can be used in circuits rated 600V or less.
- Type MIS has an interrupting rating of 200kA.

Typical Applications

- 480V Control Circuits
- PLC Circuits

Catalog Numbers (Amps)

MIS-1	MIS-4	MIS-10
MIS-2	MIS-5	MIS-12
MIS-3	MIS-8	

Test Specifications

Fuse	Load	Opening Time
All	110%	0 4 hrs. (min.)
1-5A	150%	0 6 min. (max.)
6-12A	150%	12 min. (max.)

Recommended signal block for 1/2" x 2" indicating fuses

- Page 73



KAZ

Specifications
Description: Non-fuse actuator.
Dimensions: 1/2" x 2"
 (10.3 x 50.8mm).

Ratings:
 Volts — 600Vac
 Amps — N/A
 IR — 200kA

Agency Information:
 CE, UL Listed, Guide JDVS, File E58836.

Features and Benefits

- Bussmann signal blocks 2778, 2837 or 2838 with KAZ actuators mounted in parallel with fuses having a rating of 50A or larger to provide blown fuse dropout of shunt-trip fused switches.
- Type KAZ can be used in circuits rated 600V or less.
- Type KAZ has an interrupting rating of 200kA.

Typical Applications

- Large, Shunt-Trip Fused Switches
- Fuse Protected Circuits Rated 50A or Larger With Shunt-Trip Devices.

Catalog Number: KAZ

Recommended signal block for 1/2" x 2" indicating fuses

- Page 73

Data Sheet: 2021



Low Voltage Supplementary Fuses

4164 & 4164-FR Limiter Blocks

Specifications
Description: Limiter fuse blocks for ANL & ANN.

- 4164 furnished with nylon inserted locknuts
- 4164-FR furnished with standard hex nuts

Dimensions: Length: 3.38"
 Width: 0.95"
 Height: 1.62"
 Studs center to center: 2.43"



Ratings:
 Volts — 125Vac
 — 80Vdc
 — 32Vdc (Self Certified)
 Amps — 10-800A
Poles: 1 - stud terminal

In-line Size Rejecting Fuses and Fuse Holders

GLQ

Specifications

Class: Supplemental

Description: Fast-acting, size-rejecting in-line fuse.

Construction: Glass tube.

Ratings:

Volts — 300Vac (or less)

Amps — 1-10A

IR — 10kA

Agency Information: CE, Std. 248-14, UL Listed (Guide JDYX, File E19180), CSA Certified, (Class 1422-01, File 53787).

Features and Benefits

- In-Line, fast-acting circuit protection.
- Rejection feature prevents overfusing.

Typical Applications

- In-line Lighting Ballast Protection

Catalog Numbers (Amps) and Rejection Holders

Fuse	Holder ^{1, 2}	Fuse	Holder ^{1, 2}
GLQ-1	HLQ-1- $\frac{9}{10}$	GLQ-3	HLQ-3- $\frac{2}{10}$
GLQ-1- $\frac{1}{2}$	HLQ-1- $\frac{9}{10}$	GLQ-4	HLQ-5
GLQ-1- $\frac{9}{10}$	HLQ-1- $\frac{9}{10}$	GLQ-5	HLQ-5
GLQ-2	HLQ-3- $\frac{2}{10}$	GLQ-9	HLQ-10
GLQ-2- $\frac{1}{2}$	HLQ-3- $\frac{2}{10}$	GLQ-10	HLQ-10

- Carrier is UL Recognized, Guide IZLT2, File E14853 and CSA Certified, Class 6225-01, File 47235 10A, 300Vac.
 - Units can be panel-mounted either in a knockout hole with a separate steel clip (BK/A-104) or in a keyhole punch using separate mounting clip #6374 for panels of thickness 0.043" to 0.062" or #4909 for thickness 0.030" to 0.042".
- Do not put tension on line (rear) terminal of fuse holder.

Data Sheet: 2033



GMQ

Specifications

Class: Supplemental

Description: Time-delay, size-rejecting in-line fuse.

Construction: Ceramic tube.

Ratings:

Volts — 300Vac (or less)

Amps — $\frac{1}{2}$ -6 $\frac{3}{4}$ A

IR — 10kA

Agency Information: CE, Std. 248-14, UL Listed (Guide JDYX, File E19180), CSA Certified, (Class 1422-01, File 53787).

Features and Benefits

- In-line, fast-acting circuit protection.
- Rejection feature prevents overfusing.

Typical Applications

- In-Line Lighting Ballast Protection

Catalog Numbers (Amps) and Rejection Holders

Fuse	Holders ^{1, 2}	Fuse	Holders ^{3, 4}
GMQ- $\frac{1}{2}$	HLQ- $\frac{1}{2}$	GMQ-2- $\frac{1}{2}$	HLQ-3- $\frac{2}{10}$
GMQ- $\frac{9}{10}$	HLQ-1- $\frac{9}{10}$	GMQ-3	HLQ-3- $\frac{2}{10}$
GMQ- $\frac{9}{10}$	HLQ-1- $\frac{9}{10}$	GMQ-3- $\frac{2}{10}$	HLQ-3- $\frac{2}{10}$
GMQ-1	HLQ-1- $\frac{9}{10}$	GMQ-4	HLQ-5
GMQ-1- $\frac{1}{4}$	HLQ-1- $\frac{9}{10}$	GMQ-6	HLQ-8
GMQ-1- $\frac{9}{10}$	HLQ-1- $\frac{9}{10}$	GMQ-6- $\frac{1}{4}$	
GMQ-2	HLQ-3- $\frac{2}{10}$		

- Carrier is UL Recognized, Guide IZLT2, File E14853 and CSA Certified, Class 6225-01, File 47235 10A, 300Vac.
 - Units can be panel-mounted either in a knockout hole with a separate steel clip (BK/A-104) or in a keyhole punch using separate mounting clip #6374 for panels of thickness 0.043" to 0.062" or #4909 for thickness 0.030" to 0.042".
- Do not put tension on line (rear) terminal of fuse holder.

Data Sheet: 2030



HLQ³ Fuse Holders
for both GLQ & GMQ fuses.

In-line Non-rejecting Fuses and Fuse Holders

GLR

Specifications

Class: Supplemental

Description: Fast-acting, non-rejection, in-line fuse.

Construction: Glass tube.

Ratings:

Volts — 300Vac (or less)

Amps — $\frac{3}{16}$ -15A

IR — 10kA

Agency Information: CE, Std. 248-14, UL Listed, 0-15A/300Vac (Guide JDYX, File E19180), CSA Certified, 0-10A/300V (Class 1422-01, File 53787).

Features and Benefits

- In-line, fast-acting circuit protection.

Typical Applications

- In-Line Lighting Ballast Protection



GMF

GRF

Specifications

Class: Supplemental

Description: Time-delay, non-rejection, in-line fuse.

Construction: Glass tube.

Ratings:

Volts — 300Vac (or less)

Amps — $\frac{3}{10}$ -10A

IR — 10kA

Agency Information: CE, Std. 248-14 0-10A, UL Listed (Guide JDYX, File E19180), CSA Certified, (Class 1422-01, File 53787).

Features and Benefits

- In-line, time-delay circuits protection.

Typical Applications

- In-Line Lighting Ballast Protection



Catalog Numbers (Amps) and Non-Rejection Holders

Fuse	Holder ^{1, 2*}	Fuse	Holder ^{1, 2*}
GLR- $\frac{1}{2}$	HLR	GLR-6	HLR
GLR-1	HLR	GLR-7	HLR
GLR-1- $\frac{1}{2}$	HLR	GLR-8	HLR
GLR-1- $\frac{3}{10}$	HLR	GLR-9	HLR
GLR-2	HLR	GLR-10	HLR
GLR-3	HLR	GLR-12	HLR
GLR-4	HLR	GLR-15	HLR-2A
GLR-5	HLR		

1) Carrier is UL Recognized, Guide IZLT2, File E14853 and CSA Certified, Class 6225-01, File 47235 12A, 300Vac.

2) Units can be panel-mounted either in a knockout hole with a separate steel clip (BK/A-104) or in a keyhole punch using separate mounting clip #6374 for panels of thickness 0.043" to 0.062" or #4909 for thickness 0.030" to 0.042".

* **For two leads (one each for line and loadside) order HLR-2A, 15A, 300V**

- An alternative to the HLR fuse holder is the A fuse holder. The A fuse holder comes *WITHOUT* leads. The customer inserts #18 insulated solid copper wire into the line side receptacle as well as into the load side receptacle. It has the same body dimensions, utilizes the same mounting hole, and takes the same mounting clips as the HLR. The A fuse holder is UL Recognized, 10A, 300Vac, Guide IZLT2, File E14853 and CSA Certified, 10A, 300Vac, Class 6225-01, File 47235.
- Do not put tension on line (rear) terminal of fuse holder.

Data Sheet: 2032

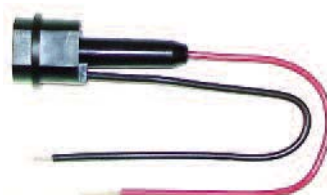

HLR-2A Fuse Holder

Catalog Numbers (-Amps) and Non-Rejection Holders

Fuse	Holder ^{1, 2*}	Fuse	Holder ^{1, 2*}
GMF- $\frac{3}{10}$	HLR	GMF-3	HLR
GMF- $\frac{1}{2}$	HLR	GMF-3- $\frac{3}{10}$	HLR
GMF- $\frac{3}{10}$	HLR	GMF-4	HLR
GMF- $\frac{3}{10}$	HLR	GMF-5	HLR
GMF-1	HLR	GMF-6- $\frac{1}{4}$	HLR
GMF-1- $\frac{1}{4}$	HLR	GMF-10	HLR
GMF-1- $\frac{3}{10}$	HLR	GRF-7	HLR
GMF-2	HLR	GRF-8	HLR
GMF-2- $\frac{1}{2}$	HLR	GRF-10	HLR
GMF-2- $\frac{3}{10}$	HLR		

1) Carrier is UL Recognized, Guide IZLT2, File E14853 and CSA Certified, Class 6225-01, File 47235 12A, 300Vac.

2) Units can be panel-mounted either in a knockout hole with a separate steel clip (BK/A-104) or in a keyhole punch using separate mounting clip #6374 for panels of thickness 0.043" to 0.062" or #4909 for thickness 0.030" to 0.042".

* **For two leads order HLR-2A, 15A, 300V**

- An alternative to the HLR fuse holder is the A fuse holder. The A fuse holder comes *WITHOUT* leads. The customer inserts #18 insulated solid copper wire into the line side receptacle as well as into the load side receptacle. It has the same body dimensions, utilizes the same mounting hole, and takes the same mounting clips as the HLR. The A fuse holder is UL Recognized, 10A, 300Vac, Guide IZLT2, File E14853 and CSA Certified, 10A, 300Vac, Class 6225-01, File 47235.
- Do not put tension on line (rear) terminal of fuse holder.

Data Sheet: 2031



HLR Fuse Holder

Automotive Blade-type Fuses & Holders

ATC Fuse



Specifications

Description: Fast-acting blade fuse.

Construction: Colored plastic housing with zinc fuse element.

Ratings:

- Volts — 32Vdc
- Amps — 1-40A
- IR — 1000A

Agency Information: UL Recognized, (3-40A) (Guide JFHR2, File E56412), SAE Standard J1284.

Features and Benefits

- Color coded plastic housing for easy identification of fuse ratings

Typical Applications

- Automotive

Catalog Numbers (Amps)

Non-Indicating	*Indicating	Color
ATC-1		Black
ATC-2		Gray
ATC-3	ATC-3ID	Violet
ATC-4		Pink
ATC-5	ATC-5ID	Tan
ATC-7-1/2	ATC-7-1/2ID	Brown
ATC-10	ATC-10ID	Red
ATC-15	ATC-15ID	Blue
ATC-20	ATC-20ID	Yellow
ATC-25	ATC-25ID	Clear
ATC-30	ATC-30ID	Green
ATC-35	ATC-35ID	Blue-Green
ATC-40	ATC-40ID	Orange

*Call Bussmann Customer Satisfaction for ordering information.

HHC, HHD, HHF, HHG & ATC-FHID

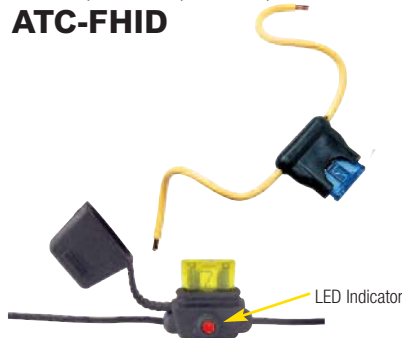

easyID™ LED Indicating Holder

Specifications

Description: In-line fuse holders for ATC™ Blade-Type fuses.

Dimensions: See Dimensions illustration.

Ratings:

- Volts: — 32Vdc
- Amps: — 80% continuous of fuse rating. See Catalog Numbers table for individual fuses sizes.

Catalog Numbers

Catalog Numbers	Fuse Holder Description	Fuse Amps	Electrical Connection
HHC	Yellow	1-20	#16 black leadwire
HHD	Black	1-30	#12 yellow leadwire
HHF	Black w/ cover	1-20	#16 yellow leadwire
HHG	Black w/ cover	1-30	#12 yellow leadwire
ATC-FHID	Indicating Holder Black w/ cover	1-20	#16 black leadwire

A fuse must be properly and fully inserted into the holder to provide a solid connection. Poor or improper insertion of the fuse can result in failure of the fuse and holder, thus not protecting the device for which it was intended.

HHC & HHD Dimensions - in

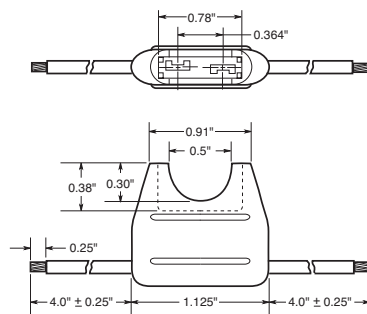

Data Sheet: 2107

ATM Fuse

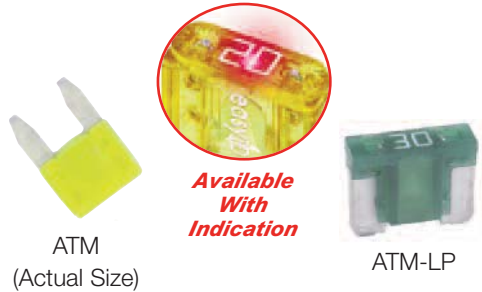

Specifications

Description: Fast-acting blade fuse.

Construction: Colored plastic housing with zinc fuse element.

Ratings:

- Volts — 32Vdc
- Amps — 2-30A
- IR — 1000A

Features and Benefits

- Color coded plastic housing for easy identification of fuse ratings

Typical Applications

- Automotive

Catalog Numbers (Amps)

Non-Indicating	*Indicating	Low-Profile	Color
ATM-2			Gray
ATM-3	ATM-3ID		Violet
ATM-4			Pink
ATM-5	ATM-5ID	ATM-5LP	Tan
ATM-7-1/2	ATM-7-1/2ID	ATM-7-1/2LP	Brown
ATM-10	ATM-10ID	ATM-10LP	Red
ATM-15	ATM-15ID	ATM-15LP	Blue
ATM-20	ATM-20ID	ATM-20LP	Yellow
ATM-25	ATM-25ID	ATM-25LP	Clear
ATM-30	ATM-30ID	ATM-30LP	Green

*Call Bussmann Customer Satisfaction for ordering information.

Data Sheet: 2048

Data Sheet: 2009

Automotive Blade-type Fuses & Holders

HHL, HHM & ATM-FHID



Specifications

Description: In-line fuse holders for ATM Fuses.

Ratings:

Volts: — 32Vdc

Amps: — 80% continuous of fuse rating. See Catalog Numbers table for individual fuses sizes.

Catalog Numbers

Catalog Numbers	Fuse Holder Description	Fuse Amps	Electrical Connection
HHL	Black w/ cover	2-20	#16 black leadwire, 4" length stripped to 1/4"
HHM	Black w/ cover	2-30	#12 red leadwire, 4" length stripped to 1/4"
ATM-FHID	Indicating Holder Black w/ cover	2-20	#16 black leadwire

A fuse must be properly and fully inserted into the holder to provide a solid connection. Poor or improper insertion of the fuse can result in failure of the fuse and holder, thus not protecting the device for which it was intended.

HHL & HHM Dimensions - in

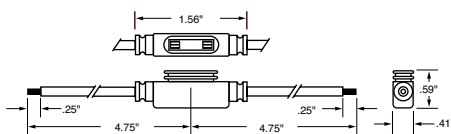

Data Sheet: 2128

MAX Maxi-Fuse

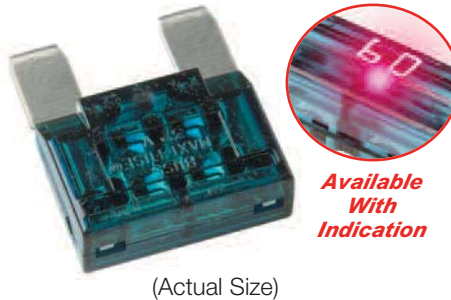

Specifications

Description: Fast-acting blade fuse.

Construction: Colored plastic housing with zinc fuse element.

Ratings:

Volts — 32Vdc

Amps — 20-80A (non-indicating)
20-100A (indicating)

IR — 1000A

Features and Benefits

- Color coded plastic housing for easy identification of fuse ratings

Typical Applications

- Automotive

Catalog Numbers (Amps)

Non-Indicating	*Indicating	Color
MAX-20	MAX-20ID	Yellow
MAX-25		Gray
MAX-30	MAX-30ID	Green
MAX-35		Brown
MAX-40	MAX-40ID	Orange
MAX-50	MAX-50ID	Red
MAX-60	MAX-60ID	Blue
MAX-70	MAX-70ID	Tan
MAX-80	MAX-80ID	Clear
	MAX-100ID	Purple

*Call Bussmann Customer Satisfaction for ordering information.

Recommended in-line fuse holder for blade type fuses

- Page 83

Data Sheet: 2049

HHX



Specifications

Description: In-line fuse holders for MAXI Fuses.

Ratings:

Volts: — 32Vdc

Amps: — 80% continuous of fuse rating. See Catalog Numbers table for individual fuses sizes.

Catalog Numbers

Catalog Numbers	Fuse Holder Description	Fuse Amps	Electrical Connection
HHX	Black w/ cover	20-60	#6 red leadwire, 5" with blunt ends

A fuse must be properly and fully inserted into the holder to provide a solid connection. Poor or improper insertion of the fuse can result in failure of the fuse and holder, thus not protecting the device for which it was intended.

Dimensions - in

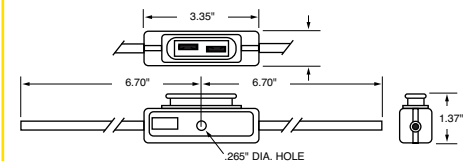

Data Sheet: 2129

Automotive Blade-type PCB Fuseclips

ATM Fuses 1A5778 Series

Dimensional Data

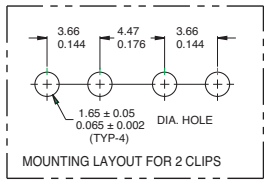
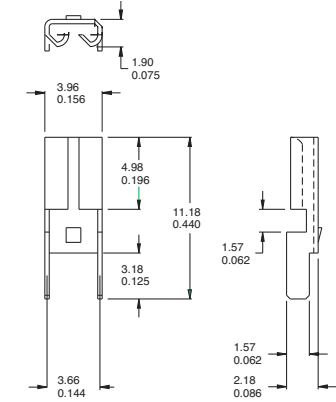

MATERIAL: BRASS, NICKEL PLATED, 0.30/0.012 THICK

Data Sheet: 2131

1A5779 Series

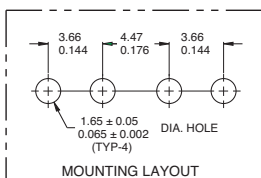
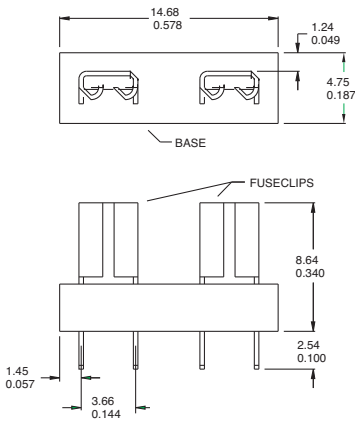

SPECIFICATIONS

FUSECLIPS	BRASS, NICKEL PLATED
BASE MATERIAL	GLASS FILLED NYLON, UL RATED 94V-0
CURRENT RATING	15 AMPS
VOLTAGE RATING	500V AC
TEMPERATURE RATING	-50°C TO 145°C -58°F TO 292°F

Data Sheet: 2131

ATC Fuses (0 to 20 Amps) 1A5600 Series

Dimensional Data

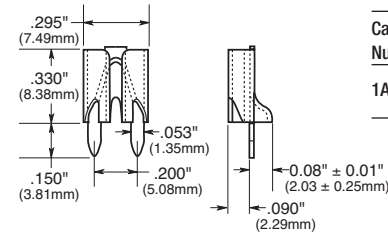

Catalog Number	Clip Mat.*	Finish
1A5600	Cart. Brass	Satin Finish Tin

Data Sheet: 2131

1A5780 Series

Dimensional Data

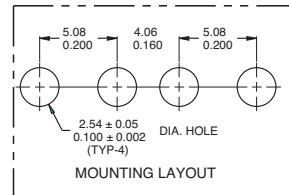
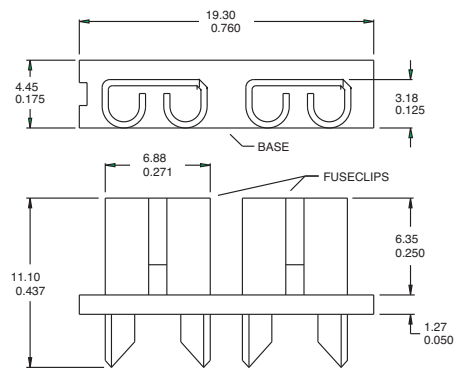

SPECIFICATIONS

FUSECLIPS	BRASS, NICKEL PLATED
BASE MATERIAL	GLASS FILLED NYLON, UL RATED 94V-0
CURRENT RATING	15 AMPS
VOLTAGE RATING	500V AC
TEMPERATURE RATING	-50°C TO 145°C -58°F 292°F

*Spg. Br. - Spring Bronze; BeCu - Beryllium Copper; Cart. Brass - Cartridge Brass

***For RoHS compliant version add "-R" option code suffix to part number.

Data Sheet: 2131

Electronic - PC Board and Small Dimension Fuses & Accessories



Section Contents

	Page
5 x 15mm ferrule fuses	86
5 x 20mm European (IEC) ferrule fuses	87-88
5 x 20mm North American (UL) ferrule fuses	89
1/4" Dia. x 5/8" to 1" length ferrule fuses	90
1/4" Dia. x 1 1/4" length fast-acting ferrule fuses	91
1/4" Dia. x 1 1/4" length time-delay ferrule fuses	92
PCB mount fuse holders	93-94
PCB fuseclips for 5mm dia. fuses	95
PCB fuseclips for 1/4" dia. fuses	96-97
PCB fuseclips for 1/4", 5/32", 13/32" & 3/8" fuses	98



Scan this tag to get the
latest product information for
Electronic Fuses and Accessories.

5 x 15mm Ferrule Fuses

C515 (axial leads)

C519

Specifications

Description:
Time-delay fuse.

Dimensions:
5 x 15mm
(0.197" X 0.591").

Construction:
Glass tube.

Ratings:

- Volts — 125Vac (3.5-7A)
- 250Vac (125mA-3A)
- 32Vdc (Self Certified)
- Amps — 125mA-7A
- IR — 25A (350mA @ 600Vac)
- 35A (125mA-1A @ 250Vac)
- 100A (1.25-3A @ 250Vac)
- 400A (3.5-7A @ 125Vac)
- 10kA (125mA-3A @ 125Vac)

Agency Information: CE, UL Listed File E19180, Guide JDYX 125mA-250mA and 375mA-3A, UL Recognized, File E19180, Guide JDYX2, 350mA and 3.5A-7A, CSA Certification File 53787, Class 1422-01, 125mA-250mA and 375mA-3A.

Features and Benefits

- Time-delay for closer sizing on inductive circuits.

Typical Application

- Electronic Circuits
- Printed Circuit Boards

Catalog Numbers (Amps)

With Axial Leads

C515-125-R	C515-800-R	C515-2.5-R
C515-250-R	C515-1-R	C515-3-R
C515-350-R	C515-1.25-R	C515-3.5-R
C515-375-R	C515-1.5-R	C515-4-R
C515-500-R	C515-1.6-R	C515-5-R
C515-600-R	C515-2-R	C515-6-R
C515-750-R	C515-2.25-R	C515-7-R

Without Axial Leads

C519-125-R	C519-750-R	C519-2.25-R
C519-250-R	C519-1-R	C519-2.5-R
C519-350-R	C519-1.25-R	C519-3-R
C519-375-R	C519-1.5-R	C519-3.5-R
C519-500-R	C519-1.6-R	C519-4-R
C519-600-R	C519-2-R	C519-5-R



C518 (axial leads)

C520

Specifications

Description:
Fast-acting fuse.

Dimensions:
5 x 15mm
(0.197" X 0.591").

Construction:
Glass tube.

Ratings:

- Volts — 250Vac
- 32Vdc (Self Certified)
- Amps — 100mA-5A
- IR — 35A (100mA-750mA @ 250Vac)
- 10kA (100mA-5A @ 125Vac)
- 100A (1.5-3.5A @ 250Vac)
- 200A (4-5A @ 250Vac)

Agency Information: CE, UL Recognized File E19180, Guide JDYX2CSA Certification File 53787, Class 1422-01.

Features and Benefits

- Small footprint saves space in equipment.
- Fast-acting for maximum component protection.
- Available in ferrule and axial leaded configurations

Typical Applications

- Electronic Circuits
- Printed Circuit Boards

Catalog Numbers (Amps)

With Axial Leads

C518-100-R	C518-750-R	C518-4-R
C518-125-R	C518-2-R	C518-5-R
C518-250-R	C518-2.5-R	
C518-375-R	C518-3-R	
C518-500-R	C518-3.5-R	

Without Axial Leads

C520-100-R	C520-750-R	C520-3.5-R
C520-125-R	C520-1.5-R	C520-4-R
C520-250-R	C520-2-R	C520-5-R
C520-375-R	C520-2.5-R	
C520-500-R	C520-3-R	



C517 (axial leads)

Specifications

Description: Fast-acting fuse.

Construction: Glass tube.

Ratings:

- Volts — 350Vac*
- 32Vdc (Self Certified)
- Amps — 3A
- IR — 100A @ 350Vac
- 100A @ 250Vac
- 10kA @ 125Vac

*350Vac/100A IR is UL Recognized

Agency Information: CE, UL Listing File E19180, Guide JDYX, CSA Certification File 53787, Class 1422-01, UL Recognized, File E19180, Guide JDYX2.

- Small footprint saves space in equipment.
- Fast-acting for maximum component protection.
- 350Vac rating for 277V ballast circuit protection.

Typical Applications

- Electronic Circuits
- Printed Circuit Boards
- Electronic Ballast Protection

Catalog Number (Amps)

With Axial Leads

C517-3-R



5 x 20mm European (IEC) Ferrule Fuses

S500-V (GDB-V)* (axial leads)

S500 (GDB)*

Specifications

Description: Fast-acting, low-breaking capacity fuse.

Construction:

Glass tube, nickel-plated brass endcaps (silver-plated endcaps, 32-125mA).

Ratings:

Volts — 250Vac (or less)
— 32Vdc (Self Certified)

Amps — 32mA-10A

IR — See catalog table

Agency Information: CE, cURus, SEMKO, VDE, BSI, IMQ, CCC.

See data sheet for complete agency information. Not all approvals apply to all ratings.

Features and Benefits

- Fast-acting for maximum protection, conforms to IEC 60127-2 (160mA-10A).

Typical Applications

- Electronic Circuits

Catalog Numbers (Amps)

Catalog Numbers	IR (Amps)	I ² t	Max Voltage Drop (mV)
S500-32-R	35	0.000047	3200
S500-40-R	35	0.00011	2500
S500-50-R	35	0.00020	2400
S500-63-R	35	0.00057	2000
S500-80-R	35	0.0012	1200
S500-100-R	35	0.003	1100
S500-125-R	35	0.005	1000
S500-160-R	35	0.008	2000
S500-200-R	35	0.016	1700
S500-250-R	35	0.028	1400
S500-315-R	35	0.058	1300
S500-400-R	35	0.018	1100
S500-500-R	35	0.018	220
S500-630-R	35	0.035	220
S500-800-R	35	0.067	190
S500-1-R	35	0.60	200
S500-1.25-R	35	0.84	200
S500-1.6-R	35	1.6	190
S500-2-R	35	4.2	150
S500-2.5-R	35	6.1	150
S500-3.15-R	35	13	130
S500-4-R	40	22	130
S500-5-R	50	42	120
S500-6.3-R	63	69	120
S500-8-R	80	-	120
S500-10-R	100	-	120

Options

Axial leads, put "V" in P/N,

*When ordering GDB version, do not add "-R" suffix to part number.

Data Sheet: 2052 (S500), 2015 (GDB)

S501-V (GDA-V)* (axial leads)

S501 (GDA)*

Specifications

Description: Fast-acting, high-breaking capacity fuse.

Construction:

Ceramic tube, nickel-plated brass endcaps (silver-plated endcaps 50mA-400mA).

Ratings:

Volts — 250Vac (or less)
— 32Vdc (Self Certified)

Amps — 50mA-10A**

IR — 1500A @ 250Vac

Agency Information: CE, cURus, SEMKO, VDE, IMQ, CCC, CSA, BSI.

See data sheet for complete agency information. Not all approvals apply to all ratings.

Features and Benefits

- Fast-acting for maximum protection.
- High break capacity for use in higher fault energy electronic circuitry.
- Conforming to IEC standards.

Typical Applications

- Electronic Circuits

Catalog Numbers (Amps)

Catalog Numbers	I ² t	Typical Voltage Drop (mV)
S501-50-R	0.0017	9000
S501-63-R	0.0005	3300
S501-80-R	0.0011	2600
S501-100-R	0.0018	2300
S501-125-R	0.0037	1900
S501-160-R	0.008	1600
S501-200-R	0.020	1350
S501-250-R	0.027	1300
S501-315-R	0.010	1400
S501-400-R	0.018	1200
S501-500-R	0.038	1050
S501-630-R	0.064	1200
S501-800-R	0.097	490
S501-1-R	0.146	330
S501-1.25-R	0.313	297
S501-1.6-R	0.748	239
S501-2-R	2.0	205
S501-2.5-R	3.9	190
S501-3.15-R	8.1	160
S501-4-R	14	160
S501-5-R	25	155
S501-6.3-R	48	150
S501-8-R	N/A	N/A
S501-10-R	N/A	N/A

Options

Axial leads, put "V" in P/N.

*When ordering GDA version, do not add "-R" suffix to part number.

**GDA is not available above 6.3A.

Data Sheet: 2051 (S501), 2014 (GDA)

S505-V (axial leads)

S505

Specifications

Description: Time-delay, high-breaking capacity fuse.

Construction:

Ceramic tube, silver-plated brass endcaps.

Ratings:

Volts — 250Vac (or less)

— 32Vdc (Self Certified)

Amps — 500mA-12A

IR — 1500A @ 250Vac

Agency Information: UL, CSA, SEMKO, VDE, BSI, IMQ, PSE/JET, CCC, EK, FIMKO.

See data sheet for complete agency information. Not all approvals apply to all ratings.

Features and Benefits

- Time-delay performance ideal for inductive circuits.
- Conforming to IEC standards.

Typical Applications

- Electronic Circuits

Catalog Numbers (Amps)

Catalog Numbers	Typical I ² t	Max Voltage Drop (mV)
S505-500-R	0.188*	295
S505-800-R	0.632*	189
S505-1-R	1.28	152.5
S505-1.25-R	2.22	150
S505-1.6-R	6.78	125
S505-2-R	9.60	118.5
S505-2.5-R	16.60	115
S505-3.15-R	36.60	102.5
S505-4-R	38.45*	86.5
S505-5-R	71.30*	77.5
S505-6.3-R	197	75
S505-8-R	311	75
S505-10-R	397	72
S505-12-R	713.7*	77

*The typical I²t value was measured at 10 times of rated current under DC.

Options

Axial leads, put "V" in P/N.

Data Sheet: 2037

5 x 20mm European (IEC) Ferrule Fuses

S505H (S505H-V)*

(axial leads)

Specifications

Description: Time-delay, high-breaking capacity fuse.

Construction:

Ceramic tube, nickel-plated brass endcaps.

Ratings:

- Volts — 600Vac/400Vdc
- 500mA-5A
- 6.3A-10A
- 500Vac/400Vdc

Amps — 500mm-10A

IR — 35A @ 250Vac

Agency Information: cURus, CCC, CQC, TUV, PSE/JET.

See data sheet for complete agency information. Not all approvals apply to all ratings.

Features and Benefits

- Time-delay, high breaking capacity
- Conforming to IEC standards

Typical Applications

- Power supplies - adapters
- Desktops/notebooks

Catalog Numbers (Amps)

Catalog Numbers	Typical I^2t (A ² s) ¹	Max Voltage Drop (mV) ³
S505H-500-R	0.188	295
S505H-800-R	0.632	189
S505H-1-R	1.28	153
S505H-1.25-R	2.22	150
S505H-1.6-R	6.78	125
S505H-2-R	11.44	128
S505H-2.5-R	24.23	126
S505H-3.15-R	43.55	121
S505H-4-R	38.45	90
S505H-5-R	71.3	89
S505H-6.3-R	111.4	80
S505H-8-R	228.2	76
S505H-10-R	349.5	72

1. Typical Pre-Arc I²t: Measured at 10I_n DC.
 2. - Breaking Capacity of 250VAC/1500A is tested by all agency approvals, test condition is 250Vac, PF: 0.7-0.8.
 - Breaking Capacity of Max. voltage is tested by UL, PF:1.
 - Breaking Capacity Test of DC is tested by UL under Capacitor Bank 4800mF (for 400V, 1500A) 2400mF (for 400V, 500A).
 3. Typical Voltage Drop: Voltage drop is measured under ambient 20°C with rated current.

Options

Axial leads, put "V" in P/N.



S506-V (GDC-V)* (axial leads)

S506 (GDC)*

Specifications

Description: Time-delay, low-breaking capacity fuse.

Construction: Glass tube, nickel-plated brass endcaps.

Ratings:

- Volts — 250Vac (or less)
- 32Vdc (Self Certified)
- Amps — 32mA-15A**
- IR — 35A @ 250Vac

Agency Information: UR, CSA, cURus, SEMKO, VDE, BSI, IMQ, PSE/JET, CCC.

See data sheet for complete agency information. Not all approvals apply to all ratings.

Features and Benefits

- Time-delay compatibility for inductive circuits
- Conforming to IEC standards

Typical Applications

- Electronic Circuits

Catalog Numbers (Amps)

Catalog Numbers	Typical I^2t	Max Voltage Drop (mV)
S506-32-R	0.0051	1050
S506-40-R	0.0072	920
S506-50-R	0.0095	800
S506-63-R	0.021	760
S506-80-R	0.038	580
S506-100-R	0.045	490
S506-125-R	0.063	390
S506-160-R	0.093	320
S506-200-R	0.114	340
S506-250-R	0.265	270
S506-315-R	0.621	250
S506-400-R	0.872	210
S506-500-R	0.827	140
S506-630-R	1.33	150
S506-800-R	2.78	75
S506-1-R	6.45	87.5
S506-1.25-R	10.05	86
S506-1.6-R	21.7	82
S506-2-R	31.6	77
S506-2.5-R	59.4	72.5
S506-3.15-R	96.4	68.5
S506-4-R	71.8	67
S506-5-R	142.5	60.5
S506-6.3-R	237.6	54
S506-8-R	255.8	55
S506-10-R	450	54
S506-12.5-R	1019.5	45
S506-15-R	1091.7	65.5

Options

Axial leads, put "V" in P/N.

*When ordering GDC version, do not add "-R" suffix to part number.

**GDC series is not available above 6.3A.



5 x 20mm North American (UL) Ferrule Fuses

GMA-V (axial leads)

GMA

Specifications

Description:

Fast-acting fuse.

Dimensions:

5 x 20mm
(0.197" x 0.788").

Construction:

Glass tube,
nickel-plated brass
endcaps.



RoHS

Ratings:

- Volts — 250Vac (63mA-2.5A)
- 125Vac (3.15-15A)
- 32Vdc (Self Certified)
- Amps — 63mA-15A
- IR — 35A (63mA- 1A @ 250Vac,
p.f. = 0.7-0.8)
- 10kA (63mA-6A @ 125Vac,
p.f. = 0.7-0.8)
- 100A (1.25-2.5A @ 250Vac,
p.f. = 0.7-0.8)
- 200A (7-8A @ 125Vac, p.f. = 1.0)
- 150A (10-15A @ 125Vac,
p.f. = 1.0)

Agency Information: CE, Std. 248-14, UL Listed Guide JDYX, File E19180, 0-6A, UL Recognized, Guide JDYX2, File E19180, 7-15A, CSA Certified, Class 1422-01, File 53787, 0-6.

Features and Benefits

- Fast-acting for maximum protection.

Typical Applications

- Electronic Circuits

Catalog Numbers (Amps)

With Axial Leads

GMA-V-63-R	GMA-V-800-R	GMA-V-4-R
GMA-V-100-R	GMA-V-1-R	GMA-V-5-R
GMA-V-125-R	GMA-V-1.25-R	GMA-V-6-R
GMA-V-200-R	GMA-V-1.5-R	GMA-V-7-R
GMA-V-250-R	GMA-V-1.6-R	GMA-V-8-R
GMA-V-300-R	GMA-V-2-R	GMA-V-10-R
GMA-V-500-R	GMA-V-2.5-R	GMA-V-15-R
GMA-V-600-R	GMA-V-3.15-R	
GMA-V-750-R	GMA-V-3.5-R	

Without Axial Leads

GMA-63-R	GMA-800-R	GMA-4-R
GMA-100-R	GMA-1-R	GMA-5-R
GMA-125-R	GMA-1.25-R	GMA-6-R
GMA-200-R	GMA-1.5-R	GMA-7-R
GMA-250-R	GMA-1.6-R	GMA-8-R
GMA-300-R	GMA-2-R	GMA-10-R
GMA-500-R	GMA-2.5-R	GMA-15-R
GMA-600-R	GMA-3.15-R	
GMA-750-R	GMA-3.5-R	

Data Sheet: 2017

GMC-V (axial leads)

GMC

Specifications

Description: Medium time-delay fuse.

Dimensions: 5 x 20mm
(0.197" x 0.788").

Construction: Glass tube, nickel-plated brass endcaps.

Ratings:

- Volts — 250Vac (63mA-3.15A)
- 125Vac (3.5-10A)
- 32Vdc (Self Certified)
- Amps — 63mA-10A
- IR — 35A (63mA- 1A @ 250Vac,
p.f. = 0.7-0.8)
- 10kA (63mA-6A @ 125Vac, p.f. = 0.7-0.8)
- 100A (1.25-3.15A @ 250Vac,
p.f. = 0.7-0.8)
- 200A (6.3-10A @ 125Vac, p.f. = 1.0)

Agency Information: CE, Std. 248-14, UL Listed Guide JDYX, File E19180, 0-6.3A, UL Recognized, Guide JDYX2, File E19180, 7-8A, CSA Certified, Class 1422-01, File 53787, 0-6.3A.

Features and Benefits

- Conforming to UL standards.

Typical Applications

- Electronic Circuits

Catalog Numbers (Amps)

With Axial Leads

GMC-V-63-R	GMC-V-500-R	GMC-V-2.5
GMC-V-80-R	GMC-V-600-R	GMC-V-3.15
GMC-V-100-R	GMC-V-630-R	GMC-V-3.5
GMC-V-125-R	GMC-V-750-R	GMC-V-4
GMC-V-150-R	GMC-V-800-R	GMC-V-5
GMC-V-200-R	GMC-V-1-R	GMC-V-6
GMC-V-250-R	GMC-V-1.25-R	GMC-V-6.3
GMC-V-300-R	GMC-V-1.5-R	GMC-V-7
GMC-V-315-R	GMC-V-1.6-R	GMC-V-8
GMC-V-400-R	GMC-V-2-R	GMC-V-10

Without Axial Leads

GMC-63mA	GMC-500-R	GMC-2.5-R
GMC-80mA	GMC-600-R	GMC-3.15-R
GMC-100mA	GMC-630-R	GMC-3.5-R
GMC-125mA	GMC-750-R	GMC-4-R
GMC-150mA	GMC-800-R	GMC-5-R
GMC-200mA	GMC-1-R	GMC-6-R
GMC-250mA	GMC-1.25-R	GMC-6.3-R
GMC-300mA	GMC-1.5-R	GMC-7-R
GMC-315mA	GMC-1.6-R	GMC-8-R
GMC-400mA	GMC-2-R	GMC-10-R

Data Sheet: 4395



RoHS

GMD-V (axial leads)

GMD

Specifications

Description: Time-delay fuse.

Dimensions: 5 x 20mm
(0.197" x 0.788").

Construction: Glass tube, nickel-plated brass endcaps.

Ratings:

- Volts — 250Vac
- 32Vdc (Self Certified)
- Amps — 125mA-4A
- IR — 10kA (125mA-3A @ 125Vac,
p.f. = 0.7-0.8)
- 10kA (4A @ 125Vac,
p.f. = 1.0)
- 35A (125mA-1A @ 250Vac,
p.f. = 0.7-0.8)
- 100A (1.2A-3.A @ 250Vac,
p.f. = 0.7-0.8)
- 200A (4A @ 250Vac,
p.f. = 1.0)

Agency Information: CE, UL Listed Guide JDYX, File E19180, 125mA-3A, UL Recognized, Guide JDYX2, File E19180, 4A, CSA Certified, Class 1422-01, File 53787, 0-4A, PSE/JET. File 1641-31003-1001, 1.2A-4A.

Features and Benefits

- Time-delay compatibility for inductive circuits.
- Conforming to UL standards.

Typical Applications

- Electronic Circuits

Catalog Numbers (Amps)

With Axial Leads

GMD-V-125-R	GMD-V-500-R	GMD-V-1.5-R
GMD-V-150-R	GMD-V-600-R	GMD-V-1.6-R
GMD-V-200-R	GMD-V-630-R	GMD-V-2-R
GMD-V-250-R	GMD-V-750-R	GMD-V-2.5-R
GMD-V-300-R	GMD-V-800-R	GMD-V-3-R
GMD-V-315-R	GMD-V-1-R	GMD-V-4-R
GMD-V-375-R	GMD-V-1.2-R	
GMD-V-400-R	GMD-V-1.25-R	

Without Axial Leads

GMD-125-R	GMD-500-R	GMD-1.5-R
GMD-150-R	GMD-600-R	GMD-1.6-R
GMD-200-R	GMD-630-R	GMD-2-R
GMD-250-R	GMD-750-R	GMD-2.5-R
GMD-300-R	GMD-800-R	GMD-3-R
GMD-315-R	GMD-1-R	GMD-4-R
GMD-375-R	GMD-1.2-R	
GMD-400-R	GMD-1.25-R	

Data Sheet: 2019



RoHS

Electronic
Fuses

1/4" Dia. x 5/8" to 1" Length Ferrule Fuses

AGA

Specifications

Description: Fast-acting fuse.

Dimensions: 1/4" x 5/8"
(6.4 x 15.9mm).

Construction: Glass tube.

Ratings:

- Volts — 125Vac (or less)
- 32Vdc (Self Certified)
- Amps — 1-30A
- IR — 10kA (1-1 1/2A @ 125Vac)
- 200A (2-5A @ 125Vac)
- 1000A (6-30A @ 32Vac)

Agency Information: CE, Std. 248-14, UL File E19180, UL Listed, Guide JDYX 0-3 1/2A UL Recognized, Guide JDYX2 12-30A.

Features and Benefits

- Fast-acting for maximum protection.
- Size rejects insertion of other fuse types.

Typical Applications

- Electronic Circuits

Catalog Numbers (Amps)

AGA-1	AGA-5	AGA-15
AGA-1-1/2	AGA-6	AGA-20
AGA-2	AGA-7	AGA-25
AGA-2-1/2	AGA-7-1/2	AGA-30
AGA-3	AGA-10	



AGW

Specifications

Description: Fast-acting fuse.

Dimensions: 1/4" x 7/8"
(6.4 x 22.2mm).

Construction: Glass tube.

Ratings:

- Volts — 32Vac
- 32Vdc (Self Certified)
- Amps — 1-30A

Features and Benefits

- Fast-acting for maximum protection.

Typical Applications

- Electronic Circuits

Catalog Numbers (Amps)

AGW-1	AGW-4	AGW-15
AGW-1-1/2	AGW-5	AGW-20
AGW-2	AGW-6	AGW-25
AGW-2-1/2	AGW-7-1/2	AGW-30
AGW-3	AGW-10	



AGX

Specifications

Description: Fast-acting fuse.

Dimensions: 1/4" x 1"
(6.4 x 25.4mm).

Construction: Glass tube.

Ratings:

- Volts — 250Vac (1/6-20A)
- 125Vac (25-30A)
- 32Vdc (1/6-30A)
- Amps — 1/6-30A

- IR — 35A (1/6-1A @ 250Vac)
- 10kA (1/6-10A @ 125Vac)
- 200A (15-20A @ 125Vac)
- 100A (25-30A @ 125Vac)
- 1000A (8-30A @ 32Vac)

Agency Information: cULus: AGX 0-10A (Guide JDYX, File E 19180 and Guide JDYX7, File E19180), UL Recognized Card: AGX 15-30A (Guide JDYX2, File E19180), CSA Component Acceptance Card : AGX 15-30A (Class No. 1422-01, File 53787)

Features and Benefits

- Size rejects insertion of other fuse types.

Typical Applications

- Electronic Circuits

Catalog Numbers (Amps)

AGX-1/4	AGX-1-1/2	AGX-8
AGX-3/16	AGX-2	AGX-10
AGX-3/8	AGX-2-1/2	AGX-15
AGX-1/2	AGX-3	AGX-20
AGX-5/8	AGX-4	AGX-25
AGX-3/4	AGX-5	AGX-30
AGX-1	AGX-6	
AGX-1-1/4	AGX-7	



1/4" Dia. x 1 1/4" Length Fast-acting Ferrule Fuses

AGC (AGC-V axial leads)

Specifications

Description:

Fast-acting fuse.

Dimensions: 1/4" x 1 1/4"
(6.4 x 31.7mm).

Construction: Glass tube with nickel-plated brass endcaps.

Ratings:

- Volts — 250Vac (1/20-10A)
- 32Vac (12-30A)
- 32Vdc (Self Certified)
- Amps — 1/20-30A
- IR — 35A (1/20-1A @ 250Vac)
- 100A (1 1/4-3A @ 250Vac)
- 200A (4-10A @ 250Vac)
- 10kA (1/20-10A @ 125Vac)
- 1000A (12-30A @ 32Vac)



RoHS

Agency Information: CE, UL Listed, Guide JDYX, File E19180, 0-10A UL Recognized, Guide JDYX2, File E19180, 12-30A CSA Certification, Class 1422-01, File 053787, 1/20-30A.

Features and Benefits

- Original electronic glass tube fuse.
- Fast-acting for maximum protection.
- Wide amp/volt ratings allow versatility of protecting electronic circuits.

Typical Applications

- Electronic Circuits

Catalog Numbers (Amps)

With Axial Leads

AGC-V-1/20-R	AGC-V-1-1/4-R	AGC-V-8-R
AGC-V-1/10-R	AGC-V-1-1/2-R	AGC-V-9-R
AGC-V-1/8-R	AGC-V-2-R	AGC-V-10-R
AGC-V-3/10-R	AGC-V-2-1/4-R	AGC-V-12-R
AGC-V-1/4-R	AGC-V-2-1/2-R	AGC-V-14-R
AGC-V-3/8-R	AGC-V-3-R	AGC-V-15-R
AGC-V-3/10-R	AGC-V-4-R	AGC-V-20-R
AGC-V-1/2-R	AGC-V-5-R	AGC-V-25-R
AGC-V-1/2-R	AGC-V-6-R	AGC-V-30-R
AGC-V-3/4-R	AGC-V-7-R	
AGC-V-1-R	AGC-V-7-1/2-R	

Without Axial Leads

AGC-1/20-R	AGC-1-1/4-R	AGC-8-R
AGC-1/10-R	AGC-1-1/2-R	AGC-9-R
AGC-1/8-R	AGC-2-R	AGC-10-R
AGC-3/10-R	AGC-2-1/4-R	AGC-12-R
AGC-1/4-R	AGC-2-1/2-R	AGC-14-R
AGC-3/8-R	AGC-3-R	AGC-15-R
AGC-3/10-R	AGC-4-R	AGC-20-R
AGC-1/2-R	AGC-5-R	AGC-25-R
AGC-1/2-R	AGC-6-R	AGC-30-R
AGC-3/4-R	AGC-7-R	
AGC-1-R	AGC-7-1/2-R	

Data Sheet: 2001

ABC (ABC-V axial leads)

Specifications

Description: Fast-acting fuse.

Dimensions: 1/4" x 1 1/4"
(6.4 x 31.7mm).

Construction: Ceramic tube with nickel-plated brass endcaps.

Ratings:

- Volts — 250Vac/125Vdc (1/4-15A, 20-30A)*
- 250Vac (18A)
- 32Vdc (Self Certified)
- Amps — 1/4-30A
- IR** — 35A (1/4-1A @ 250Vac)
- 100A (1 1/4-3A @ 250Vac)
- 200A (4-10A @ 250Vac)
- 750A (12-15A @ 250Vac)
- 400A (18-20A @ 250Vac)
- 10kA (1/4-15A @ 125Vac)
- 1kA (18-30A @ 125Vac)
- 10kA (1/4-15, 20A @ 125Vdc)
- 400A (25-30A @ 125Vdc)
- 200A (25-30A @ 250Vac)



RoHS

*CSA approvals for 25A and 30A are at 125Vac - IR 1000A and Vdc - IR 400A (IR 1000A at 75Vdc)

**Interrupting ratings measured at 70% - 80% power factor on AC. The interrupting ratings for 18A and 20A were measured at 85%-95% power factor on AC. The interrupting ratings for 25A and 30A were measured at 89% power factor on AC.

Agency Information: CE, Std. 248-14 UL Listed, Guide JDYX File E19180, 1/4-15A; UL Recognized, Guide JDYX2, File E19180, 18-30A; CSA Certification, Class 1422-01 & 1422-30, File 53787, 1/4-30A.

Features and Benefits

- Ceramic body allows for higher amp/volt rating combinations.

Typical Applications

- Electronic Circuits

Catalog Numbers (Amps)

With Axial Leads

ABC-V-1/4-R	ABC-V-3-R	ABC-V-12-R
ABC-V-1/2-R	ABC-V-4-R	ABC-V-15-R
ABC-V-3/4-R	ABC-V-5-R	ABC-V-18-R
ABC-V-1-R	ABC-V-6-R	ABC-V-20-R
ABC-V-1-1/2-R	ABC-V-7-R	ABC-V-25-R
ABC-V-2-R	ABC-V-8-R	ABC-V-30-R
ABC-V-2-1/2-R	ABC-V-10-R	

Without Axial Leads

ABC-1/4-R	ABC-3-R	ABC-12-R
ABC-1/2-R	ABC-4-R	ABC-15-R
ABC-3/4-R	ABC-5-R	ABC-18-R
ABC-1-R	ABC-6-R	ABC-20-R
ABC-1-1/2-R	ABC-7-R	ABC-25-R
ABC-2-R	ABC-8-R	ABC-30-R
ABC-2-1/2-R	ABC-10-R	

Data Sheet: 2000

GBB (GBB-V axial leads)

Specifications

Description: Very fast-acting fuse.

Dimensions: 1/4" x 1 1/4"
(6.4 x 31.7mm).

Construction: Ceramic cartridge with nickel-plated brass endcaps.

Ratings:

- Volts — 250Vac/125Vdc
- Amps — 1-30A
- IR — 200A @ 250Vac
- 200A (20-30A @ 125Vac/dc)
- 10,000A (1A -15A @ 125Vac/dc)



RoHS

Agency Information:

CE, Std. 248-14, UL Recognized, 1-30, 125Vdc/250Vac, File E56412, Guide JFHR2, CSA Accepted, 1-30, 125Vdc/250Vac, File 53787, Class 1422-30.

Features and Benefits

- Very fast-acting performance allows protection of highly sensitive electronic circuitry.

Typical Applications

- Electronic Circuits

Catalog Numbers (Amps)

With Axial Leads

GBB-V-1-R	GBB-V-6-R	GBB-V-15-R
GBB-V-1-1/4-R	GBB-V-7-R	GBB-V-20-R
GBB-V-2-R	GBB-V-8-R	GBB-V-25-R
GBB-V-3-R	GBB-V-9-R	GBB-V-30-R
GBB-V-4-R	GBB-V-10-R	
GBB-V-5-R	GBB-V-12-R	

Without Axial Leads

GBB-1-R	GBB-6-R	GBB-15-R
GBB-1-1/4-R	GBB-7-R	GBB-20-R
GBB-2-R	GBB-8-R	GBB-25-R
GBB-3-R	GBB-9-R	GBB-30-R
GBB-4-R	GBB-10-R	
GBB-5-R	GBB-12-R	

Data Sheet: 2013

1/4" Dia. x 1 1/4" Length Time-delay Ferrule Fuses

MDL-V (axial leads)

MDL

Specifications

Description:

Time-delay fuse.

Dimensions: 1/4" x 1 1/4"
(6.4 x 31.7mm).

Construction: Glass tube with nickel-plated brass endcaps.

Ratings:

- Volts — 250Vac (1/6-8A)
- 32Vac (9-30A)
- 32Vdc (Self Certified)
- Amps — 1/6-30A
- IR* — 35A (1/6-1A @ 250Vac)
- 100A (1 1/4-3A @ 250Vac)
- 200A (4-8A @ 250Vac)
- 10000A (1/6-8A @ 125Vac)
- 1000A (9-30A @ 32Vac)



*Interrupting ratings were measured at 70% – 80% power factor on AC, and at a time constant described in UL 198L.

Agency Information: CE, UL Listed, Guide JDYX, File E19180, 1/6-8A; CSA Certification Class 1422-01, 1/6-8A; UL Recognized, Guide JDYX2, File E19180, 9-30A; CSA Component Acceptance, Class 142230, 9-30A.

Features and Benefits

- Time-delay allows close sizing on inductive circuits.

Typical Applications

- Electronic Circuits

Catalog Numbers (Amps)

With Axial Leads

MDL-V-1/6-R	MDL-V-1-R	MDL-V-7-R
MDL-V-1/10-R	MDL-V-1-1/4-R	MDL-V-8-R
MDL-V-1/8-R	MDL-V-1-1/2-R	MDL-V-9-R
MDL-V-3/16-R	MDL-V-2-R	MDL-V-10-R
MDL-V-1/4-R	MDL-V-2-1/2-R	MDL-V-12-R
MDL-V-3/8-R	MDL-V-2-1/2-R	MDL-V-15-R
MDL-V-1/2-R	MDL-V-3-R	MDL-V-20-R
MDL-V-3/4-R	MDL-V-4-R	MDL-V-25*
MDL-V-5/8-R	MDL-V-5-R	MDL-V-30*
MDL-V-3/4-R	MDL-V-6-R	

Without Axial Leads

MDL-1/6-R	MDL-1-R	MDL-7-R
MDL-1/10-R	MDL-1-1/4-R	MDL-8-R
MDL-1/8-R	MDL-1-1/2-R	MDL-9-R
MDL-3/16-R	MDL-2-R	MDL-10-R
MDL-1/4-R	MDL-2-1/2-R	MDL-12-R
MDL-3/8-R	MDL-2-1/2-R	MDL-15-R
MDL-1/2-R	MDL-3-R	MDL-20-R
MDL-3/4-R	MDL-4-R	MDL-25*
MDL-5/8-R	MDL-5-R	MDL-30*

*MDL-25 & MDL-30 are not available in RoHS compliant construction.

Data Sheet:2004

MDQ-V (axial leads)

MDQ

Specifications

Description:

Dual-element, time-delay fuse.

Dimensions: 1/4" x 1 1/4"
(6.4 x 31.7mm).

Construction: Glass tube with nickel-plated brass endcaps.

Ratings:

- Volts — 250Vac (1/100-7A)
- 32Vac (7 1/2-15A)
- 32Vdc (Self Certified)
- Amps — 1/100-15A
- IR — 35A (1/100-1A @ 250Vac)
- 100A (1 1/4-3A @ 250Vac)
- 200A (4-7A @ 250Vac)
- 1000A (7 1/2-12A @ 32Vac)



Agency Information: Std. 248-14, UL Listed, File E19180; Guide JDYX, 1/6-7A CSA Certification, File 47233, Class 1422-01, 1/6-7A, UL Recognized, Guide JDYX2, File E19180, 7.1-30A.

Features and Benefits

- Dual-element design allows closer sizing to inductive circuits than any other fuses.

Typical Applications

- Electronic Relay and Control Circuits

Catalog Numbers (Amps)

With Axial Leads

MDQ-V-1/100	MDQ-V-1/50	MDQ-V-1-1/2	MDQ-V-5
MDQ-V-1/50	MDQ-V-1/25	MDQ-V-1-1/10	MDQ-V-6
MDQ-V-1/16	MDQ-V-1/10	MDQ-V-1-1/10	MDQ-V-6-1/2
MDQ-V-1/10	MDQ-V-1/5	MDQ-V-2	MDQ-V-7
MDQ-V-1/5	MDQ-V-1/5	MDQ-V-2-1/4	MDQ-V-7-1/2
MDQ-V-15/100	MDQ-V-1/3	MDQ-V-2-1/2	MDQ-V-8
MDQ-V-175/1000	MDQ-V-1/2	MDQ-V-2-1/2	MDQ-V-9
MDQ-V-1/30	MDQ-V-1	MDQ-V-3	MDQ-V-10
MDQ-V-1/30	MDQ-V-1-1/10	MDQ-V-3-1/10	MDQ-V-12
MDQ-V-1/4	MDQ-V-1-1/4	MDQ-V-4	MDQ-15

Without Axial Leads

MDQ-1/100	MDQ-1/50	MDQ-1-1/2	MDQ-5
MDQ-1/50	MDQ-1/25	MDQ-1-1/10	MDQ-6
MDQ-1/16	MDQ-1/10	MDQ-1-1/10	MDQ-6-1/2
MDQ-1/10	MDQ-1/5	MDQ-2	MDQ-7
MDQ-1/5	MDQ-1/5	MDQ-2-1/4	MDQ-7-1/2
MDQ-15/100	MDQ-1/3	MDQ-2-1/2	MDQ-8
MDQ-175/1000	MDQ-1/2	MDQ-2-1/2	MDQ-9
MDQ-1/30	MDQ-1	MDQ-3	MDQ-10
MDQ-1/30	MDQ-1-1/10	MDQ-3-1/10	MDQ-12
MDQ-1/4	MDQ-1-1/4	MDQ-4	MDQ-15

Data Sheet: 2044

MDA-V (axial leads)

MDA

Specifications

Description:

Time-delay fuse.

Dimensions: 1/4" x 1 1/4" (6.35 x 31.75mm).

Construction: Ceramic tube with nickel-plated brass endcaps.

Ratings:

- Volts — 250Vac (or less)
- 125Vdc (20A- 30A)
- 32Vdc (Self Certified)
- Amps — 1/4-30A
- IR** — 35A (1/4-1A @ 250Vac)
- 100A (1 1/2-2A @ 250Vac)
- 200A (2 1/2-10A @ 250Vac)
- 750A (12-15A @ 250Vac)
- 1500A (20-30A @ 250Vac)
- 10kA (1/4-30A @ 125Vac)
- 10kA (20-30A @ 125Vdc)



**Interrupting ratings were measured at 70% – 80% power factor on AC, and at a time constant described in UL 248.

Agency Information: CE, Std. 248-14, UL Listed, Guide JDYX, File E19180, 0-20A CSA Certification, Class 1422-01, File 53787, 0-20A. UL Recognized, Guide JDYX2, File E19180, 25-30A, CSA Component Acceptance, Class 1422-30, 25-30A

Features and Benefits

- Ceramic body allows for higher amp/volt rating combinations.
- Inventory consolidation by replacing MDL fuses allows for reduced SKU investment and minimizing potential for misapplying fuse.

Typical Applications

- Electronic Circuits

Catalog Numbers (Amps)

With Axial Leads

MDA-V-1/4-R	MDA-V-3-R	MDA-V-12-R
MDA-V-1/2-R	MDA-V-4-R	MDA-V-15-R
MDA-V-3/4-R	MDA-V-5-R	MDA-V-20-R
MDA-V-1-R	MDA-V-6-R	MDA-V-25-R
MDA-V-1-1/2-R	MDA-V-7-R	MDA-V-30-R
MDA-V-2-R	MDA-V-8-R	
MDA-V-2-1/2-R	MDA-V-10-R	

Without Axial Leads

MDA-1/4-R	MDA-3-R	MDA-12-R
MDA-1/2-R	MDA-4-R	MDA-15-R
MDA-3/4-R	MDA-5-R	MDA-20-R
MDA-1-R	MDA-6-R	MDA-25A-R
MDA-1-1/2-R	MDA-7-R	MDA-30A-R
MDA-2-R	MDA-8-R	
MDA-2-1/2-R	MDA-10-R	

Data Sheet: 2002

PC Board Mount Fuse Holders

HTC-45M



PCB Vertical Mount

Specifications

Description: PCB vertical mount bayonet cap and fuse holder.

Dimensions: See Dimensions illustration.

Ratings:

See Specifications table.

Agency Information:

See Specifications table notes 1, 2, 5.

Dimensions - in (mm)

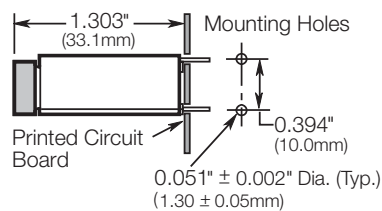

Data Sheet 2110

HTC-50M



PCB Horizontal Mount

Specifications

Description: PCB horizontal mount bayonet cap and fuse holder.

Dimensions: See Dimensions illustration.

Ratings:

See Specifications table.

Agency Information:

See Specifications table notes 1, 2.

Dimensions - in (mm)

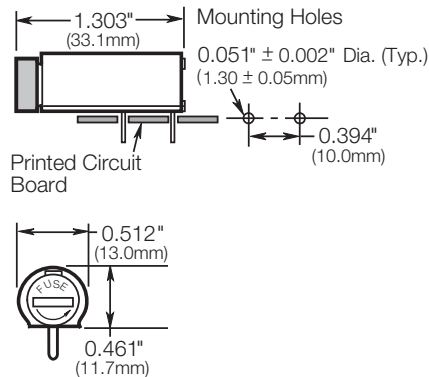

Data Sheet 2110

HTC-60M

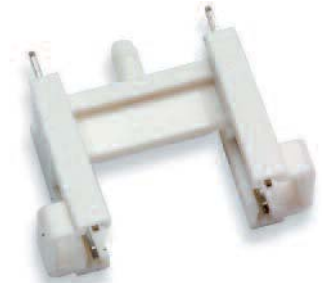

PCB Stand-Off Mount

Specifications

Description: Four-leg PCB stand-off fuse holder.

Dimensions: See Dimensions illustration.

Ratings:

Volts: — 250V

Amps: — 6.3A

Agency Information:

See Specifications table notes 1, 4.

Dimensions - in (mm)

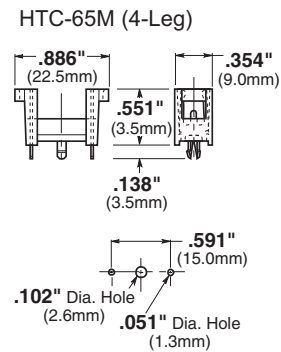

Data Sheet 2110

Specifications

Terminals — Tin-plated brass with 3mm (HTC-35M, -55M) and 4.8mm (HTC-70M).

Molded Materials — High temperature thermoplastic that meets the flammability ratings of UL 94VO; Glow Wire Test: 960°C per IEC 695-2-1.

Solderability — In accordance with IEC 68-2-20.

Electrical — Contact Resistance: ≤10mW; Insulation Resistance: ≥10MW; Dielectric Strength ≥2000Vac.

Shock Safety — PC2 (fuse holders).

Agency Information:

- 1) cURus: Guide 1ZLT2 & 1ZLT8, File E14853
- 2) VDE: 40004457
- 3) VDE: 40004458
- 4) VDE: 40004459
- 5) VDE: 40004463

PC Board Mount Fuse Holders

HBH-I (for 1/4" x 1 1/4" fuses)

HBH-M (for 5 x 20mm fuses)

PCB Horizontal Mount

Specifications

Description: PCB horizontal mount fuse holder.

Dimensions: See Dimensions illustration.

Ratings: See Specifications table.

Dimensions - in (mm)

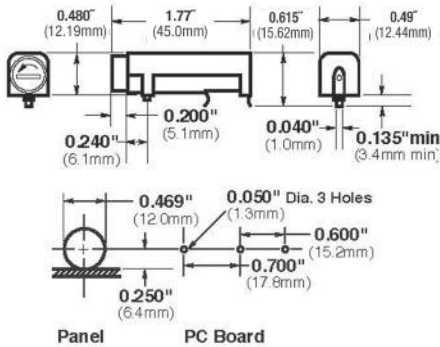

Data Sheet: 2118

HBV-I (for 1/4" x 1 1/4" fuses)

HBV-M (for 5 x 20mm fuses)

PCB Vertical Mount with Stability Pins

Specifications

Description: PCB vertical mount fuse holder with stability pins.

Dimensions: See Dimensions illustration.

Ratings: See Specifications table.

Dimensions - in (mm)

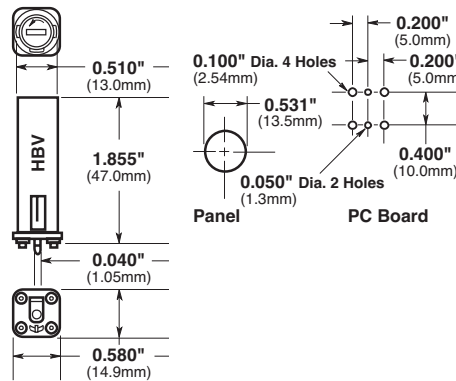

Data Sheet: 2118

HBW-I (for 1/4" x 1 1/4" fuses)

HBW-M (for 5 x 20mm fuses)

PCB Vertical Mount without Stability Pins

Specifications

Description: PCB vertical mount fuse holder without stability pins.

Dimensions: See Dimensions illustration.

Ratings: See Specifications table.

Dimensions - in (mm)

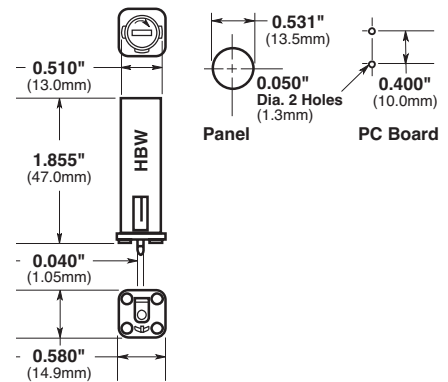

Data Sheet: 2118



FBI



FBM

Fuse Holder Caps (Fit all three shown above)

Specifications

Electrical Ratings: UL — 16A @ 250V; CSA — 12A @ 250V; VDE — 6.3A @ 250V; SEMKO — 10A @ 250V
Insulation resistance — 10 megohm at 500Vdc. **Contact resistance** — less than 0.005 ohms @ 200mV. **Dielectric strength** — over 200V/mil.

Molded Material: High dielectric molded phenolic with a UL 94V0 flammability rating.

Fuse Carrier & Knob: Spring-loaded, bayonet-type. Tin plated brass. Screwdriver slotted.

Mounting: "Kicked" terminals (all models) and stabilizer pins on HBV & HBW models for increased stability.

Temperature Rating (RTI): Body: 150°C, Knob: 130°C

Agency Information: CE, UL Recognized — Guide IZLT2, File EI4853;

CSA Certified — Class 6225-01, File 47235

VDE — 4009241 (HBV, HBW)

SEMKO — 800444

PC Board Fuseclips for 5mm Diameter Fuses

HTC-15M, HTC-140M

PCB Mounted Fuse Holder & Snap-On Cover

Voltage Rating: 250V, 6.3A, 1.6W

HTC-15M (fuse holder), HTC-140M (natural cover),
HTC-150M* (transparent cover)



Agency Information: See Specifications table notes 1, 3
on bottom of page 65

*Available in bulk only. Use this format: BK/HTC-150M
Data Sheet: 2110

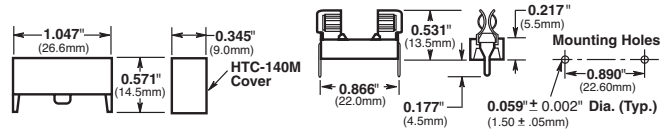

HTC-200M

PCB Mounted Fuseclip

Construction: Tin-plated bronze

Tape and Fan Fold packed

Ammo Pack (AP/HTC-200M) 1000 pieces per box

Data Sheet: 2110

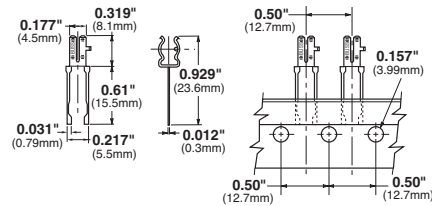

HTC-210M

PCB Mounted Fuseclip with End Stops

Data Sheet: 2110

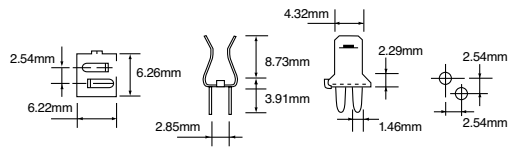

1A3399 Series

PCB Fuseclips with End Stops & Straight Leads

Catalog Numbers	Clip Material*	Finish
1A3399-01	Beryllium copper*	Silver
1A3399-04-R	Beryllium copper*	Bright tin
1A3399-10-R	Spring bronze	Bright tin

*Beryllium copper recommended for amps higher than 15 amps.

Data Sheet: 2131

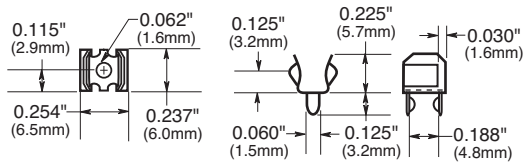

1A5018 Series

PCB High Profile Fuseclips with End Stops & Straight Leads

Catalog Numbers	Clip Material*	Finish
1A5018-7	Spring bronze	Silver
1A5018-10-R	Spring bronze	Bright tin

*Beryllium copper recommended for amps higher than 15 amps.

Data Sheet: 2131

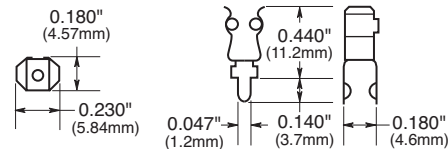

1A5601 Series

PCB Fuseclips (0-7A)

Catalog Number	Clip Material	Finish
1A5601	Cartridge brass	Bright tin

Data Sheet: 2131

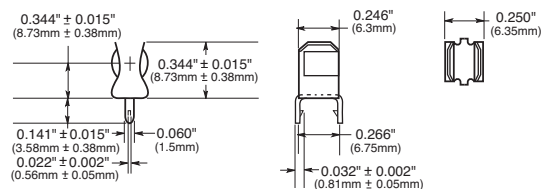

1A5602 Series

PCB Fuseclips (0-7A)

Catalog Number	Clip Material	Finish
1A5602	Cartridge brass	Bright tin

Data Sheet: 2131

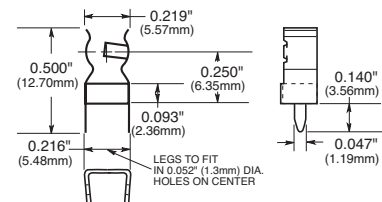

Electronic Fuses

PC Board Fuseclips for 1/4" Diameter Fuses

1A3398 Series

PCB Fuseclips without End Stops with Straight Leads

Catalog Numbers	Clip Material	Finish
1A3398-07-R	Cartridge brass	Bright tin

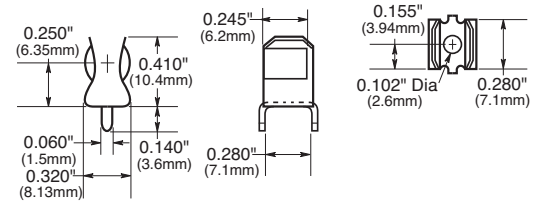

1A1907 Series

PCB Fuseclips with End Stops & Straight Leads

Catalog Numbers	Clip Material*	Finish
1A1907-02	Cartridge brass	None/bright dipped
1A1907-03-R	High Performance Copper*	Bright tin
1A1907-05	High Performance Copper*	Silver
1A1907-06-R	Cartridge brass	Bright tin

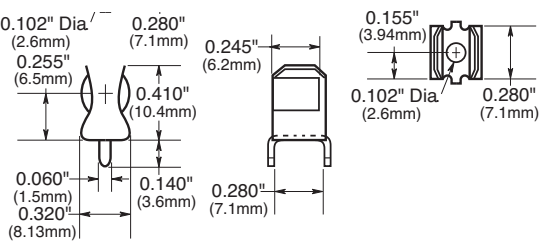

*High Performance Copper recommended for amps higher than 15A.

Data Sheet: 2131

1A4533 Series

PCB Fuseclips without End Stops or Angled Out Leads

Catalog Numbers	Clip Material*	Finish
1A4533-01-R	High Performance Copper*	Bright tin
1A4533-06-R	Cartridge brass	Bright tin

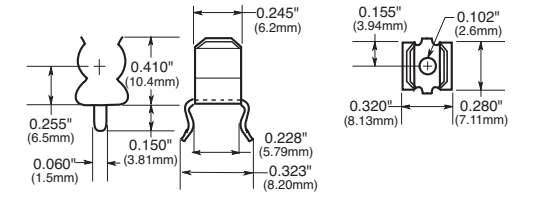

*High Performance Copper recommended for amps higher than 15A.

Data Sheet: 2131

1A4534 Series

PCB Fuseclips with End Stops & Angled Out Leads

Catalog Numbers	Clip Material*	Finish
1A4534-01-R	High Performance Copper*	Bright tin
1A4534-06-R	Cartridge brass	Bright tin

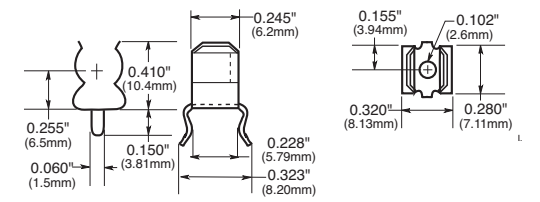

*High Performance Copper recommended for amps higher than 15A.

Data Sheet: 2131

1A1119 Series

Fuseclips with End Stops & Angled In Leads

Catalog Numbers	Clip Material*	Finish
1A1119-04-R	High Performance Copper*	Bright tin
1A1119-05	High Performance Copper*	Silver
1A1119-10-R	Cartridge brass	Bright tin

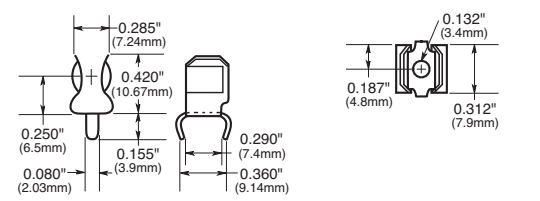

*High Performance Copper recommended for amps higher than 15A.

Data Sheet: 2131

1A1120 Series

PCB Fuseclips without End Stops or Angled In Leads

Catalog Numbers	Clip Material*	Finish
1A1120-02	Cartridge brass	None/bright dipped
1A1120-05	High Performance Copper*	Silver
1A1120-06-R	High Performance Copper*	Bright tin
1A1120-09-R	Cartridge brass	Bright tin

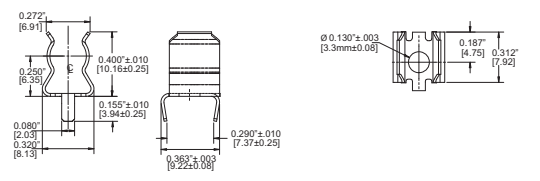

*High Performance Copper recommended for amps higher than 15A.

Data Sheet: 2131

PC Board Fuseclips for 1/4" Diameter Fuses

5681 & 5682 Series

PCB Fuseclips with Mounting Holes For 1/4" Diameter Fuses

Catalog Number	End Stop	Clip Mat.**	Finish	Dimensions (Inches)					Hole Dia.	Ref.
				B (To End Stop)	C (Contact)	D (Height)	E (Width)			
5681-01	No	BeCu	Silver	†	0.265	0.41	0.32	0.132	Fig. 2	
5681-08		Spg. Br.	Nickel							
5681-15-R		Spg. Br.	Bright Tin							
5682-01	Yes	BeCu	Silver	0.108	0.262	0.41	0.32	0.132	Fig. 1	
5682-02		BeCu	Silver							
5682-11-R		BeCu	Bright Tin	0.131						
5682-41-R		Spg. Br.	Bright Tin	0.106						
5682-44-R		Spg. Br.	Bright Tin	0.132						

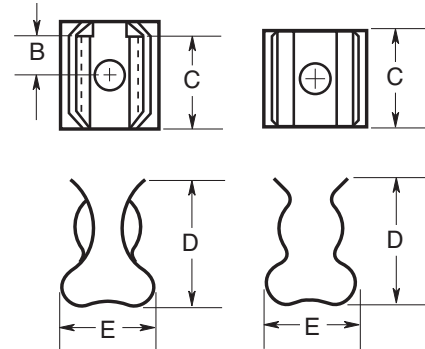

Figure 1

Figure 2

PC Board Fuseclips for 1/32", 13/32" and 1/16" Diameter Fuses

5672 & 5674 Series

PCB Fuseclips with Mounting Holes For 1/32" Diameter Fuses

Catalog Number	End Stop	Clip Mat.**	Finish	Dimensions (Inches)					Ref.
				B (To End Stop)	C (Contact)	D (Height)	E (Width)	Hole Dia.	
5672-11	No	Spg. Br.	Bright Tin	†	0.362	0.52	0.38	0.172	Fig. 2
5674-01	Yes	BeCu	Silver	0.168	0.356	0.52	0.38	0.172	Fig. 1
5674-10		BeCu	Bright Tin						
5674-41		Spg. Br.	Bright Tin						

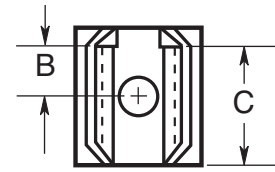

1A3400 Series***

For 13/32" Diameter Fuses
With End Stops & Straight Leads

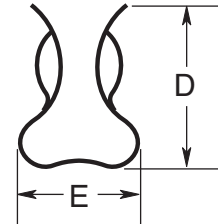
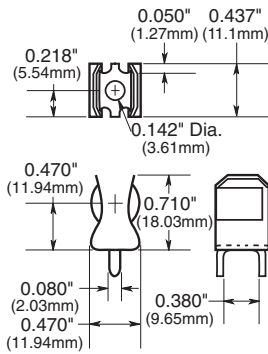
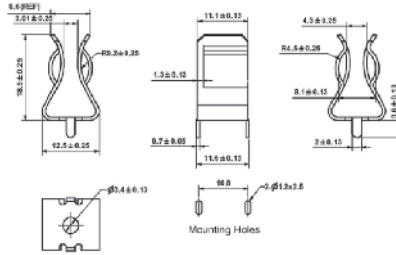

Figure 1

Dimensional Data



1A3400-09 & 1A3400-10



1A3400-12

Specifications:

Catalog Number	Clip Material	Finish	Amp Rating
1A3400-09	Spring Bronze	Bright Tin	20A Max.
1A3400-10	Beryllium Copper	Silver	30A Max.
1A3400-12	Spring Brass	Bright Tin	15A Max.

***For RoHS compliant version add "-R" option code suffix to part number.

5956 & 5960 Series

PCB Fuseclips with Mounting Holes For 1/32" Diameter Fuses

Catalog Number	End Stop	Clip Mat.**	Finish	Dimensions (Inches)					Ref.	
				B (To End Stop)	C (Contact)	D (Height)	E (Width)	Hole Dia.		
5956-16	No	Spg. Br.	Bright Tin	†	0.312	0.71	0.47	0.172	Fig. 2	
5960-07	Yes	BeCu	Silver	0.168	0.387	0.71	0.47	0.196	Fig. 1	
5960-09		BeCu	Silver							0.20
5960-44		Spg. Br.	Nickel							0.20
5960-51		Spg. Br.	Bright Dip*							0.168
5960-53		Spg. Br.	Bright Dip*							0.20
5960-61-R		Spg. Br.	Bright Tin							0.168
5960-62-R		Spg. Br.	Bright Tin							0.168
5960-63-R		Spg. Br.	Bright Tin							0.20
5960-64-R		Spr. Br.	Bright Tin							0.20

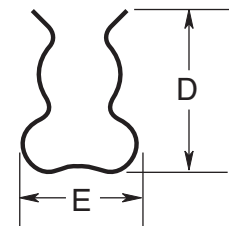
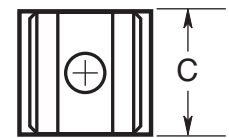

Figure 2

5591 & 5592 Series

PCB Fuseclips with Mounting Holes For 1/16" Diameter Fuses



Catalog Number	End Stop	Clip Mat.**	Finish	Dimensions (Inches)					Ref.
				B (To End Stop)	C (Contact)	D (Height)	E (Width)	Hole Dia.	
5591-42	Yes	Spg. Br.	Bright Dip*	0.26	0.51	0.89	0.60	0.172	Fig. 1
5591-52-R		Spg. Br.	Bright Tin						
5592-01	No	BeCu	Silver	0.252	0.56	0.875	0.60	0.20	Fig. 2

* Bright Dip is actually treated bare metal with no plating.
** Spg. Br. — Spring Bronze; BeCu — Beryllium Copper.
† Hole in center of both clip and contact area.

Medium Voltage Fuses



Section Contents

	Page
Introduction	100
E-Rated Fuses	
For transformers & feeders	101-104
CL-14 & bolt-in	105-107
For potential & small power transformers	108-110
PT fuses	111
R-Rated fuses for motor circuit protection .	112-114
British IEC fuses for motor circuit protection . . .	115
DIN IEC fuses for transformer protection	116
Expulsion Fuse Links	117-118
EEL-NEMA Type K & T and Type H & N fuses . . .	119
Fuseclips for medium and high voltage fuses . . .	120



Scan this tag to get the latest product information for Medium Voltage Fuses.

Medium Voltage Fuses

Worldwide Circuit Protection Solutions

Bussmann is a world-leading supplier of medium voltage fuses. Each product is backed by an efficient worldwide distribution network with unrivaled service and technical support. Bussmann circuit protection solutions comply with major international standards: ANSI, BS, DIN, IEC and UL.

Fuse Types

Medium voltage fuses generally fit into two categories – expulsion fuses and current limiting fuses. The definitions per ANSI C37.40 are:

Expulsion Fuse: “A vented fuse in which the expulsion effect of the gases produced by internal arcing, either alone or aided by other mechanisms results in current interruption.” Expulsion fuses will limit the duration of an overcurrent event, but they will not limit the magnitude of fault current.

Current Limiting Fuse: “A fuse unit that, when in its current-responsive element is melted by a current within the fuse’s specified current-limiting range, abruptly introduces a high resistance to reduce current magnitude and duration, resulting in subsequent current interruption.” A current limiting fuse will reduce the magnitude a fault current as well as limit the duration of the overcurrent event when operating in its current limiting range. Bussmann offers a broad range of current limiting fuses for protection of feeders, transformers and motor circuits designed to ANSI, BS, DIN and IEC standards.

Medium Voltage Current Limiting Fuses

Current limiting fuses are classified into three categories:

1. Full Range – defined by ANSI C37.40 as “a fuse capable of interrupting all currents from the maximum rated interrupting current down to the minimum continuous current that causes the melting of the fusible element(s), when the fuse is applied at the maximum ambient temperature specified by the manufacturer.” It is able to interrupt any current that will melt its element.
2. General Purpose – defined by ANSI C37.40 as “a fuse capable of interrupting all currents from the maximum rated interrupting current down to the current that causes melting of the fusible element(s) in one hour.” Not all currents fall

within this range. It is possible for the fuse to be exposed to an overcurrent lower than the value given by the one hour criteria. In that case, a different overcurrent protection device would be required to interrupt the overcurrent.

3. Back-up – defined by ANSI C37.40 as “a fuse capable of interrupting all currents from the maximum interrupting rating current down to the minimum interrupting current.” The minimum interrupting current is the lowest current that the fuse will be able to clear properly. This creates a need to place a low current interrupting device, such as motor overloads, in series with the back-up rated fuse.

E- and R-Rated Fuses

In North America, current limiting fuses typically fall into the category of E-Rated fuses and R-Rated fuses. Bussmann also offers a wide range of current limiting fuses designed to BS, DIN and IEC standards.

E-Rated fuses are used to protect feeder circuits, power transformers and potential transformers. E-Rated fuses have defined current response times specified by ANSI C37.46. E-Rated fuses 100A and below must melt in 300sec at an rms current within the range of 200% to 240% of the continuous current rating. E-Rated fuses above 100A must melt in 600sec at an rms current within the range of 240% to 264% of the continuous current rating of the fuse. Bussmann offers a wide variety of full range and general purpose E-Rated fuses from 2.4kV up to 38kV.

R-Rated fuses are back-up fuses that provide short-circuit protection for motor circuits. They are applied with MV motor starters which provide the overload protection for the circuit. R-Rated fuses also have defined current response times specified by ANSI C37.46. R-Rated fuses will melt in a range of 15 – 35sec at a current equal to 100 times the “R” rating. Bussmann offers 2.4kV, 5.08kV, 7.2kV and 8.3kV R-Rated fuses for motor circuit protection.

E-Rated Fuses for Transformers and Feeders

MV055

Specifications

Description: E-rated medium, voltage current-limiting fuses for transformer and feeder protection.



Dimensions: See Catalog Numbers table.

Construction: Silver ribbon element surrounded by silica filler housed in a fiberglass tube and plated endcaps. An epoxy paint protects the fuse tube from the surrounding environment.

Ratings:

- Volts: — 5.5kV (10-450A)
- Amps: — 5-450A (5.5kV)
- IR: — 50kA Sym. Max

Agency Information: Meets E requirements per ANSI C37.46, Meets full range requirements per ANSI C37.40.

Features and Benefits

- MV055 Standard clip center distance of 12 inches with 2 and 3 inch barrel diameters for retrofitting in existing hardware
- Open fuse indicator for ease in troubleshooting
- Full range rating with 50KA Interrupting Rating
- Double pulsed at 90% of minimum I²t to establish manufacturing reliability

MV055 Typical Applications

- 5.0kV Transformer Primary Protection
- 5.0kV Feeder Circuit Protection
- 5.0kV Voltage Switches
- 5.0kV Metal-enclosed Switchgear

Dimensions - in

Diagram 1

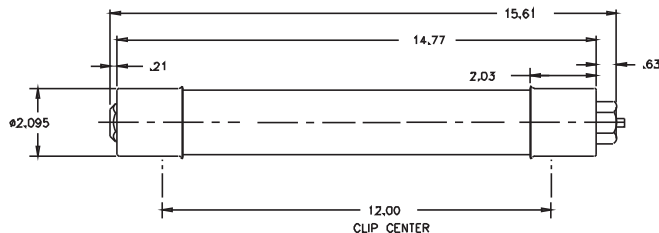
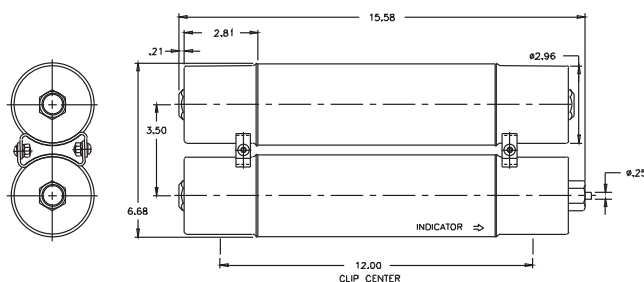

Diagram 2



5.5kV Catalog Numbers

Catalog Numbers	Amp Rating	Min Melt I ² t	Max Clear I ² t	Dimensions (in)*			
				Length	Dia.	Clip Center	Barrels
MV055F1CAX10E	10	850	8,000	15.75	1	12	1
MV055F1CAX15E	15	2,070	11,000				
MV055F1CAX20E	20	2,370	23,000				
MV055F1CAX25E	25	4,650	31,000				
MV055F1CAX30E	30	9,490	45,000				
MV055F1CAX40E	40	9,490	45,000				
MV055F1CAX50E	50	13,600	90,000				
MV055F1CAX65E	65	30,700	181,000				
MV055F1DAX10E	10	850	8,000				
MV055F1DAX15E	15	2,070	12,000				
MV055F1DAX20E	20	2,370	23,000	2	12	1	
MV055F1DAX25E	25	4,650	31,000				
MV055F1DAX30E	30	9,490	45,000				
MV055F1DAX40E	40	9,490	45,000				
MV055F1DAX50E	50	13,600	90,000				
MV055F1DAX65E	65	30,700	181,000				
MV055F1DAX80E	80	54,600	270,000				
MV055F1DAX100E	100	116,200	580,000				
MV055F1DAX125E	125	167,400	600,000				
MV055F1DAX150E	150	218,700	786,000				
MV055F1DAX175E	175	227,900	1,100,000	2	12	2	
MV055F2DAX200E	200	297,600	1,520,000				
MV055F2DAX250E	250	669,600	2,400,000				
MV055F2DAX300E	300	874,800	3,149,000				
MV055F2DAX350E	350	911,600	4,376,000				
MV055F2DAX400E	400	1,190,400	6,071,000				
MV055F2DAX450E	450	1,555,000	9,796,000				

1" = 25.4mm

Recommended Fuse Clips - see page 120

Data Sheet: 6700

E-Rated Fuses for Transformers and Feeders

MV155

Specifications

Description: E-rated medium, voltage current-limiting fuses for transformer and feeder protection.



Dimensions: See Catalog Numbers table.

Construction: Silver ribbon element surrounded by silica filler housed in a fiberglass tube and plated endcaps. An epoxy paint protects the fuse tube from the surrounding environment.

Ratings:

Volts: — 15.5kV (5-200A)

Amps: — 5-200A (15.5kV)

IR: — 50kA Sym. Max

Agency Information: Meets E requirements per ANSI C37.46, Meets full range requirements per ANSI C37.40.

Features and Benefits

- MV155 Standard clip center distance of 15 and 18 inches with 2 and 3 inch barrel diameters for retrofitting in existing hardware
- Open fuse indicator for ease in troubleshooting
- Full range rating with 50kA Interrupting Rating
- Double pulsed at 90% of minimum I²t to establish manufacturing reliability

MV155 Typical Applications

- 15.0kV Transformer Primary Protection
- 15.0kV Feeder Circuit Protection
- 15.0kV Voltage Switches
- 15.0kV Metal-enclosed Switchgear

Dimensions - in

Diagram 1

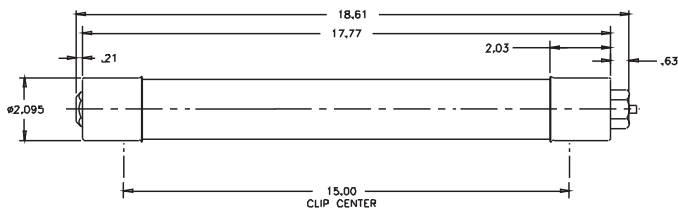
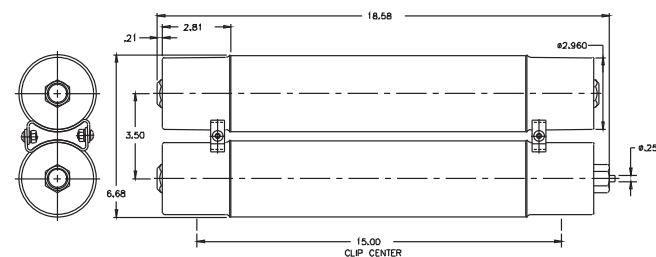

Diagram 2



Data Sheet: 6700

15.5kV Catalog Numbers

Catalog Numbers	Amp Rating	Min Melt I ² t	Max Clear I ² t	Dimensions*			
				Length	Dia.	Clip Center	Barrels
MV155F1CBX5E	5	180	2,900	18.75	1	15	1
MV155F1CBX7E	7	850	8,000				
MV155F1CBX10E	10	850	8,000				
MV155F1CBX15E	15	2,070	12,000				
MV155F1CBX20E	20	2,370	23,000				
MV155F1CBX25E	25	4,650	31,000				
MV155F1CBX30E	30	9,490	45,000				
MV155F1DBX10E	10	850	8,000				
MV155F1DBX15E	15	2,070	12,000				
MV155F1DBX20E	20	2,370	23,000				
MV155F1DBX25E	25	4,650	31,000	21.75	2	18	2
MV155F1DBX30E	30	9,490	45,000				
MV155F1DBX40E	40	9,490	45,000				
MV155F1DBX50E	50	13,600	90,000				
MV155F1DBX65E	65	30,700	181,000				
MV155F1DBX80E	80	54,600	270,000				
MV155F1DBX100E	100	116,200	600,000				
MV155F2DBX125E	125	123,000	677,000				
MV155F2DBX150E	150	218,700	1,287,000				
MV155F2DBX175E	175	314,700	1,689,000				
MV155F2DBX200E	200	465,100	2,405,000	18	18	1	2
MV155F1DCX65E	65	30,700	181,000				
MV155F1DCX80E	80	54,600	270,000				
MV155F1DCX100E	100	116,200	600,000				
MV155F2DCX125E	125	123,000	677,000				
MV155F2DCX150E	150	218,700	1,287,000				
MV155F2DCX175E	175	314,700	1,689,000				
MV155F2DCX200E	200	465,100	2,405,000				

*1" = 25.4mm.

Recommended Fuse Clips - see page 120

Data Sheet: 6701

E-Rated Fuses for Transformer & Feeders

JCX, JCY, JCU, JCZ and JDZ

Specifications

Description: Indoor/enclosure E-rated medium voltage, current-limiting fuses for feeders and power transformers with blown fuse indication.

Dimensions: See Catalog Numbers table.

Construction: plated ferrules.

Ratings:

Volts: — 2750-8300V - See Catalog Numbers table for details

Amps: — ½-750A

IR: — 40-63kA Sym

— 60-100kA ASYM

— See Catalog Numbers table for details

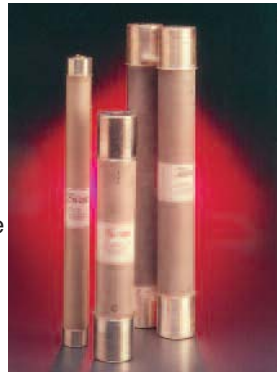

Features and Benefits

- Physically dimensioned for retrofitting in existing hardware
- Open fuse indicator for ease in troubleshooting
- Full range ANSI classification

Typical Applications

- Medium Voltage Transformer Primary Protection
- Medium Voltage Feeder Circuit Protection
- Medium Voltage Switches
- Medium Voltage Metal-enclosed Switchgear

Catalog Numbers

Catalog Numbers	Amp Rating	Maximum Design Voltage	Construction	Maximum Interrupting Capacity		Dimensions - in (mm)	
				Amps (Asym.)	Amps (Sym.)	Length	Diameter
2400V; E-Rated; Indoor/Enclosure							
JCX-1E	1	2750	Single	60,000	40,000	9.19 (233.38)	2 (50.8)
JCX-2E	2	2750	Single	60,000	40,000	9.19 (233.38)	2 (50.8)
JCX-3E	3	2750	Single	60,000	40,000	9.19 (233.38)	2 (50.8)
JCX-5E	5	2750	Single	60,000	40,000	9.19 (233.38)	2 (50.8)
JCX-7E	7	2750	Single	60,000	40,000	9.19 (233.38)	2 (50.8)
JCX-10E	10	2750	Single	60,000	40,000	9.19 (233.38)	2 (50.8)
JCX-15E	15	2750	Single	80,000	50,000	9.5 (241.3)	2.1 (53.34)
JCX-20E	20	2750	Single	80,000	50,000	9.5 (241.3)	2.1 (53.34)
JCX-25E	25	2750	Single	80,000	50,000	9.5 (241.3)	2.1 (53.34)
JCX-30E	30	2750	Single	80,000	50,000	10.81 (276.35)	3 (76.2)
JCX-40E	40	2750	Single	80,000	50,000	10.81 (276.35)	3 (76.2)
JCX-50E	50	2750	Single	80,000	50,000	10.81 (276.35)	3 (76.2)
JCX-65E	65	2750	Single	80,000	50,000	10.81 (276.35)	3 (76.2)
JCX-80E	80	2750	Single	80,000	50,000	10.81 (276.35)	3 (76.2)
JCX-100E	100	2750	Single	80,000	40,000	10.81 (276.35)	3 (76.2)
JCX-125E	125	2750	Single	80,000	50,000	10.81 (276.35)	3 (76.2)
JCX-150E	150	2750	Single	80,000	50,000	10.81 (276.35)	3 (76.2)
JCX-200E	200	2750	Single	80,000	50,000	10.81 (276.35)	3 (76.2)
JCX-225E	225	2750	Single	80,000	50,000	10.81 (276.35)	3 (76.2)
JCX-250E/280X	250/280	2750	Double	80,000	50,000	10.81 (276.35)	3 (76.2)
JCX-300E/325X	300/325	2750	Double	80,000	50,000	10.81 (276.35)	3 (76.2)
JCX-350X	350	2750	Double	80,000	50,000	10.81 (276.35)	3 (76.2)
JCX-400X	400	2750	Double	80,000	50,000	10.81 (276.35)	3 (76.2)
JCX-450X	450	2750	Double	80,000	50,000	10.81 (276.35)	3 (76.2)
5500V; E-Rated; Indoor/Enclosure							
JCY-½E	0.5	5500	Single	60,000	40,000	11.19 (284.18)	2 (50.8)
JCY-1E	1	5500	Single	60,000	40,000	11.19 (284.18)	2 (50.8)
JCY-2E	2	5500	Single	60,000	40,000	11.19 (284.18)	2 (50.8)
JCY-3E	3	5500	Single	60,000	40,000	11.19 (284.18)	2 (50.8)
JCY-5E	5	5500	Single	60,000	40,000	11.19 (284.18)	2 (50.8)
JCY-7E	7	5500	Single	60,000	40,000	11.19 (284.18)	2 (50.8)
JCY-10E	10	5500	Single	60,000	40,000	11.19 (284.18)	2 (50.8)
JCY-15E	15	5500	Single	60,000	40,000	11.19 (284.18)	2 (50.8)
JCY-20E	20	5500	Single	60,000	40,000	11.19 (284.18)	2 (50.8)
JCY-25E	25	5500	Single	60,000	40,000	11.19 (284.18)	2 (50.8)

Contact Bussmann for the latest product information on E-Rated fuses for transformer and feeder protection. Recommended fuseclips: see page 120 - 1A0065, 9078A67G04, A3354730

E-Rated Fuses for Transformer & Feeders

Catalog Numbers: E-Rated; Indoor/Enclosure

Catalog Numbers	Amp Rating	Maximum Design Voltage	Construction	Maximum Interrupting Capacity		Dimensions - in (mm)	
				Amps. (Asym.)	Amps. (Sym.)	Length	Diameter
5500V; E-Rated; Indoor/Enclosure							
JCU-10E	10	5500	Single	80,000	50,000	17.81 (452.4)	3 (76.2)
JCU-15E	15	5500	Single	80,000	50,000	12.88 (327.0)	2.1 (53.34)
JCU-20E	20	5500	Single	80,000	50,000	12.88 (327.0)	2.1 (53.34)
JCU-25E	25	5500	Single	80,000	50,000	12.88 (327.0)	2.1 (53.34)
JCU-30E	30	5500	Single	100,000	63,000	17.88 (454.15)	3 (76.20)
JCU-40E	40	5500	Single	100,000	63,000	17.88 (454.15)	3 (76.20)
JCU-50E	50	5500	Single	100,000	63,000	17.88 (454.15)	3 (76.20)
JCU-65E	60	5500	Single	100,000	63,000	17.88 (454.15)	3 (76.20)
JCU-80E	80	5500	Single	100,000	63,000	17.88 (454.15)	3 (76.20)
JCU-100E	100	5500	Single	100,000	63,000	17.88 (454.15)	3 (76.20)
JCU-125E	125	5500	Single	100,000	63,000	17.88 (454.15)	3 (76.20)
JCU-150E	150	5500	Single	100,000	63,000	17.88 (454.15)	3 (76.20)
JCU-175E	175	5500	Single	100,000	63,000	17.88 (454.15)	3 (76.20)
JCU-200E	200	5500	Single	100,000	63,000	17.88 (454.15)	3 (76.20)
JCU-250E	250	5500	Single	100,000	63,000	17.88 (454.15)	3 (76.20)
JCU-300E	300	5500	Double	100,000	63,000	17.88 (454.15)	3 (76.20)
JCU-350E	350	5500	Double	100,000	63,000	17.88 (454.15)	3 (76.20)
JCU-400E	400	5500	Double	100,000	63,000	17.88 (454.15)	3 (76.20)
JCU-450E	450	5500	Double	100,000	63,000	17.88 (454.15)	3 (76.20)
JCU-600E	600	5500	*	80,000	50,000	28.81 (731.77)	4 (101.60)
JCU-750E	750	5500	*	80,000	50,000	28.81 (731.77)	4 (101.60)
8300V; E-Rated; Indoor/Enclosure							
JCZ-15E	15	8300	Single	80,000	50,000	15.51 (393.95)	2.1 (53.34)
JCZ-20E	20	8300	Single	80,000	50,000	15.51 (393.95)	2.1 (53.34)
JCZ-25E	25	8300	Single	80,000	50,000	15.51 (393.95)	2.1 (53.34)
JCZ-30E	30	8300	Single	80,000	50,000	17.88 (454.15)	3 (76.2)
JCZ-40E	40	8300	Single	80,000	50,000	17.88 (454.15)	3 (76.2)
JCZ-50E	50	8300	Single	80,000	50,000	17.88 (454.15)	3 (76.2)
JCZ-65E	65	8300	Single	80,000	50,000	17.88 (454.15)	3 (76.2)
JCZ-80E	80	8300	Single	80,000	50,000	17.88 (454.15)	3 (76.2)
JCZ-100E	100	8300	Single	80,000	50,000	17.88 (454.15)	3 (76.2)
JCZ-125E	125	8300	Single	80,000	50,000	17.88 (454.15)	3 (76.2)
JCZ-150E	150	8300	Single	80,000	50,000	17.88 (454.15)	3 (76.2)
JCZ-200E	200	8300	Double	80,000	50,000	17.88 (454.15)	3 (76.2)
JDZ-20E	20	8300	Single	80,000	50,000	15.88 (403.2)	3 (76.2)
JDZ-25E	25	8300	Single	80,000	50,000	15.88 (403.2)	3 (76.2)
JDZ-30E	30	8300	Single	80,000	50,000	15.88 (403.2)	3 (76.2)
JDZ-40E	40	8300	Single	80,000	50,000	15.88 (403.2)	3 (76.2)
JDZ-50E	50	8300	Single	80,000	50,000	15.88 (403.2)	3 (76.2)
JDZ-65E	65	8300	Single	80,000	50,000	15.88 (403.2)	3 (76.2)
JDZ-80E	80	8300	Double	80,000	50,000	15.88 (403.2)	3 (76.2)
JDZ-100E	100	8300	Double	80,000	50,000	15.88 (403.2)	3 (76.2)
JDZ-125E	125	8300	Double	80,000	50,000	15.88 (403.2)	3 (76.2)

Recommended fuseclips: see page 120 - 1A0065, 9078A67G04, A3354730

General Notes:

1. All fuses are fitted with a striker pin which can be used for indication or tripping purposes.
2. The fuses are suitable for use either indoors or outdoors.
3. These fuses are interchangeable with corresponding fuses produced by most other leading North American manufacturers.

Contact Bussmann for the latest product information on E-Rated fuses for transformer and feeder protection.

*Bolt on mounting

E-Rated Fuses: CL-14 & Bolt-In

ECL055

Specifications

Description: E-rated medium voltage, current-limiting fuses for transformer and feeder protection.

Construction: Filament wound, glass epoxy fuse tube, with silica filler, and silver-plated copper terminals and endcaps containing a silver element in a double concentric helical configuration.

Ratings:

Volts: — 5.5kV

Amps: — 10-900A

IR: — 63kA Sym. Max

Agency Information: Meets E requirements per ANSI C37.46, Meets General Purpose requirements per ANSI C37.40.

Features and Benefits

- Clip-lock and bolt-in style available in double and triple barrel fuse designs for application flexibility
- The filament wound, glass epoxy fuse tube provides moisture protection for the fuse. This makes Cooper Bussmann medium voltage fuses suitable for both indoor and outdoor application (outdoor applications require installation inside an appropriate enclosure)
- Open fuse indication (indicator travel distance is 16mm) easily integrates into automation schemes
- 50/60Hz operating frequency make these fuses applicable world-wide

Typical Applications

- 5.0kV Transformer Primary Protection
- 5.0kV Feeder Circuit Protection
- 5.0kV Voltage Switches
- 5.0kV Metal-enclosed Switchgear

Dimensions - in

Single Barrel

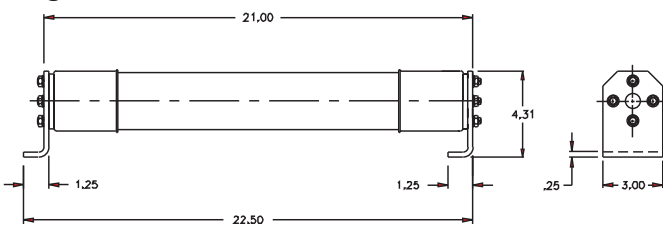

Double Barrel

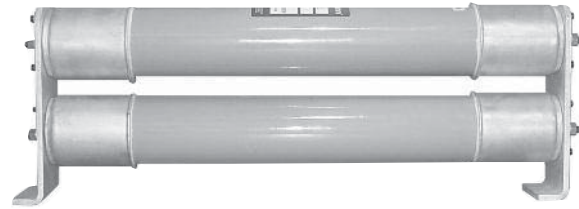
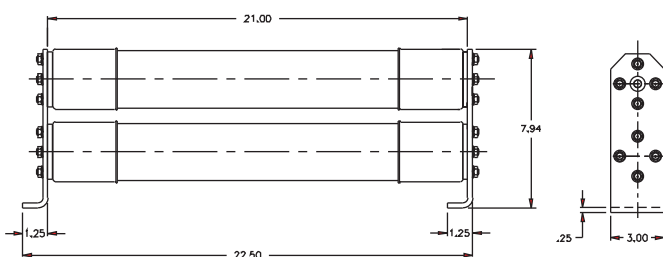

Catalog Numbers

Catalog Numbers	Amp Rating	Voltage	IR Max Sym.	# of Barrels	Style
ECL055-10E	10	5.5kV	63kA	1	Clip-Lock
ECL055-15E	15	—			
ECL055-20E	20	—			
ECL055-25E	25	—			
ECL055-30E	30	—			
ECL055-40E	40	—			
ECL055-50E	50	—			
ECL055-65E	65	—			
ECL055-80E	80	—			
ECL055-100E	100	—			
ECL055-125E	125	—			
ECL055-150E	150	—			
ECL055-200E	200	—			
ECL055-250E	250	—			
ECL055-300E	300	—			
ECL055-400E	400	—			
ECL055-450E	450	—			
ECL055-500E	500	—			
ECL055-600E	600	—			
ECL055-750E	750	—			
ECL055-900E	900	—			
				2	Clip-Lock
				3	Bolt-In

Catalog Number Construction (Example)

Catalog Number	Voltage Rating	Amp Rating
ECL	055	500E
	055 = 5.5 kV	

Catalog Number Cross Reference

Bussmann Catalog Numbers	Mersen New Catalog #	Mersen Old Catalog #
ECL055-10E	A055C1DORO-10E	225-007-937
ECL055-15E	A055C1DORO-15E	225-007-938
ECL055-20E	A055C1DORO-20E	225-007-939
ECL055-25E	A055C1DORO-25E	225-007-940
ECL055-30E	A055C1DORO-30E	225-007-941
ECL055-40E	A055C1DORO-40E	225-007-942
ECL055-50E	A055C1DORO-50E	225-007-943
ECL055-65E	A055C1DORO-65E	225-007-944
ECL055-80E	A055C1DORO-80E	225-007-945
ECL055-100E	A055C1DORO-100E	225-007-946
ECL055-125E	A055C1DORO-125E	225-007-947
ECL055-150E	A055C1DORO-150E	225-007-948
ECL055-200E	A055C1DORO-200E	225-007-949
ECL055-250E	A055C1DORO-250E	225-007-950
ECL055-300E	A055C1DORO-300E	225-007-951
ECL055-400E	A055C1DORO-400E	225-007-952
ECL055-450E	A055C2DORO-450E	225-007-953
ECL055-500E	A055C2DORO-500E	225-007-954
ECL055-600E	A055C2DORO-600E	225-007-955
ECL055-750E	A055B3DORO-750E	A055X750E-4
ECL055-900E	A055B3DORO-900E	A055X900E-4

Data Sheet: 9002

E-Rated Fuses: CL-14 & Bolt-In

ECL083

Specifications

Description: E-rated medium voltage, current-limiting fuses for transformer and feeder protection.

Construction: Filament wound, glass epoxy fuse tube, with silica filler, and silver-plated copper terminals and endcaps containing a silver element in a double concentric helical configuration.

Ratings:

- Volts: — 8.3kV
- Amps: — 65-350A
- IR: — 50kA

Agency Information: Meets E requirements per ANSI C37.46, Meets General Purpose requirements per ANSI C37.40.

Features and Benefits

- Clip-lock and bolt-in style available in double and triple barrel fuse designs for application flexibility
- The filament wound, glass epoxy fuse tube provides moisture protection for the fuse. This makes Cooper Bussmann medium voltage fuses suitable for both indoor and outdoor application (outdoor applications require installation inside an appropriate enclosure)
- Open fuse indication (indicator travel distance is 16mm) easily integrates into automation schemes
- 50/60Hz operating frequency make these fuses applicable world-wide

Typical Applications

- 8.0kV Transformer Primary Protection
- 8.0kV Feeder Circuit Protection
- 8.0kV Voltage Switches
- 8.0kV Metal-enclosed Switchgear

Dimensions - in

Single Barrel

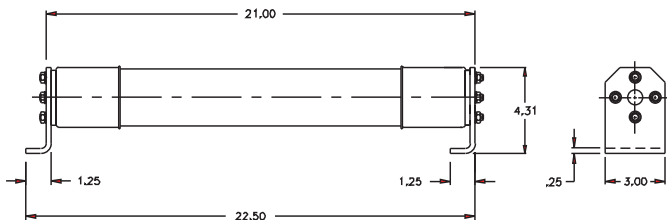

Double Barrel

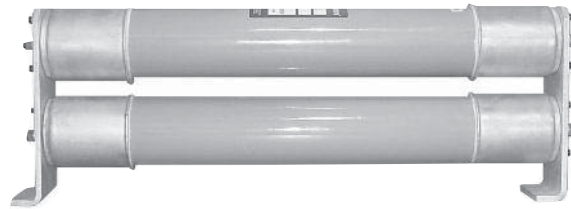
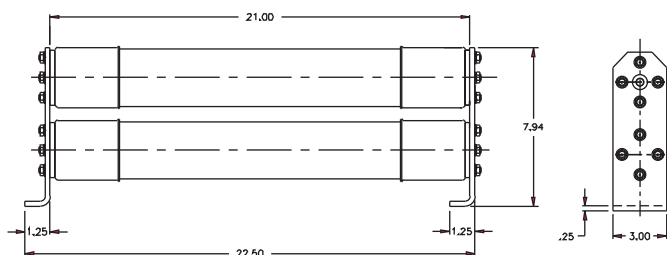

Catalog Number Construction (Example)

Catalog Number	Voltage Rating	Amp Rating
ECL	083	300E
	083 = 8.3 kV	

Electrical Characteristics

Part Number	Amps	Volts	IR Max Sym.	# of Barrels	Figure #	Style
ECL083-65E	65	8.3kV	50kA	1	1	Clip-Lock
ECL083-80E	80	8.3kV	50kA	1	1	Clip-Lock
ECL083-100E	100	8.3kV	50kA	1	1	Clip-Lock
ECL083-125E	125	8.3kV	50kA	1	1	Clip-Lock
ECL083-150E	150	8.3kV	50kA	1	1	Clip-Lock
ECL083-175E	175	8.3kV	50kA	1	1	Clip-Lock
ECL083-200E	200	8.3kV	50kA	2	2	Clip-Lock
ECL083-250E	250	8.3kV	50kA	2	2	Clip-Lock
ECL083-300E	300	8.3kV	50kA	2	2	Clip-Lock
ECL083-350E	350	8.3kV	50kA	2	2	Clip-Lock

Catalog Number Cross Reference

Bussmann Catalog Numbers	Mersen New Catalog #	Mersen Old Catalog #
ECL083-65E	N/A	N/A
ECL083-80E	N/A	N/A
ECL083-100E	N/A	N/A
ECL083-125E	N/A	N/A
ECL083-150E	N/A	N/A
ECL083-175E	N/A	N/A
ECL083-200E	N/A	N/A
ECL083-250E	N/A	N/A
ECL083-300E	N/A	N/A
ECL083-350E	N/A	N/A

Data Sheet: 9007

E-Rated Fuses: CL-14

ECL155

Specifications

Description: E-rated medium voltage, current-limiting fuses for transformer and feeder protection.

Construction: Filament wound, glass epoxy fuse tube, with silica filler, and silver-plated copper terminals and endcaps containing a silver element in a double concentric helical configuration.

Ratings:

Volts: — 15.5kV

Amps: — 10-300A

IR: — 63kA Sym. (10-200A)

— 50kA Sym. (250-300A)

Agency Information: Meets E requirements per ANSI C37.46, Meets General Purpose requirements per ANSI C37.40.

Features and Benefits

- Clip-lock double barrel fuse design assures positive installation
- The filament wound, glass epoxy fuse tube provides moisture protection for the fuse. This makes Cooper Bussmann medium voltage fuses suitable for both indoor and outdoor application (outdoor applications require installation inside an appropriate enclosure)
- Open fuse indication (indicator travel distance is 16mm) easily integrates into automation schemes
- 50/60Hz operating frequency make these fuses applicable world-wide

Typical Applications

- 15.0kV Transformer Primary Protection
- 15.0kV Feeder Circuit Protection
- 15.0kV Voltage Switches
- 15.0kV Metal-enclosed Switchgear

Dimensions - in

Single Barrel

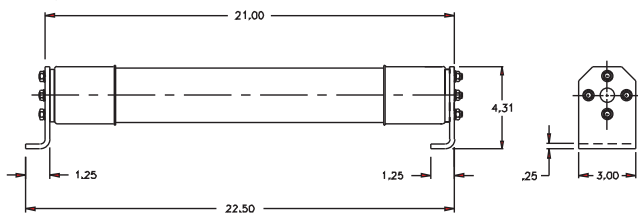

Double Barrel

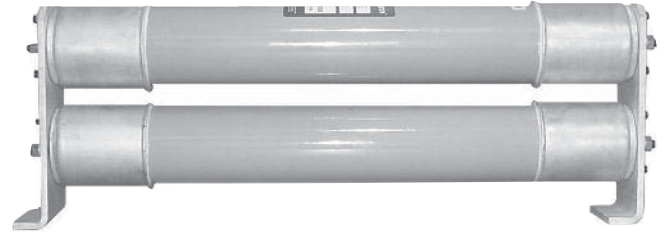
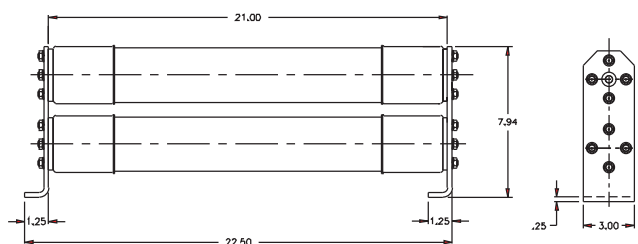

Catalog Numbers

Catalog Numbers	Amp Rating	Voltage	IR Voltage Max Sym.	# of Barrels	Style
ECL155-10E	10	15.5kV	63kA	1	Clip-Lock
ECL155-15E	15				
ECL155-20E	20				
ECL155-25E	25				
ECL155-30E	30				
ECL155-40E	40				
ECL155-50E	50				
ECL155-65E	65				
ECL155-80E	80				
ECL155-100E	100				
ECL155-125E	125	50kA		2	
ECL155-150E	150				
ECL155-200E	200				
ECL155-250E	250				
ECL155-300E	300				

Catalog Number Construction (Example)

Catalog Number	Voltage Rating	Amp Rating
ECL	155	300E
	155 = 15.5 kV	

Catalog Number Cross Reference

Bussmann Catalog Numbers	Mersen New Catalog #	Mersen Old Catalog #
ECL155-10E	A155C1DORO-10E	225-007-967
ECL155-15E	A155C1DORO-15E	225-007-968
ECL155-20E	A155C1DORO-20E	225-007-969
ECL155-25E	A155C1DORO-25E	225-007-970
ECL155-30E	A155C1DORO-30E	225-007-971
ECL155-40E	A155C1DORO-40E	225-007-972
ECL155-50E	A155C1DORO-50E	225-007-973
ECL155-65E	A155C1DORO-65E	225-007-974
ECL155-80E	A155C1DORO-80E	225-007-975
ECL155-100E	A155C1DORO-100E	225-007-976
ECL155-125E	A155C2DORO-125E	225-007-977
ECL155-150E	A155C3DORO-150E	225-007-978
ECL155-200E	A155C3DORO-200E	225-007-979
ECL155-250E	A155C3DORO-250E	225-007-980
ECL155-300E	A155C3DORO-300E	225-007-981

Data Sheet: 9004

E-Rated Fuses for Potential & Small Power Transformers

AB, AD, AM and CAV



Ratings:

- Volts: — 5.5-38kV
- Amps: — 0.5-15A
- IR: — 40kA-80kA Sym.
- See Catalog Numbers table for details

Features and Benefits

- Sized for retrofitting in existing hardware
- Space saving size

Typical Applications

- Primary protection of medium voltage potential transformers
- Primary protection of small medium voltage service transformers
- Primary protection of small medium voltage control transformers

Specifications

Description: Indicating and non-indicating E-Rated medium voltage, current-limiting fuses for potential and small power transformers.

Dimensions: See Catalog Numbers table.
Dimension Illustration on the following page

Catalog Numbers: E-Rated PT Fuses, Indicating & Non-Indicating

3.6kV; E-Rated PT Fuse; Non-indicating

Catalog Number	Amp Rating	Rated Voltage	IR RMS Sym.	Dimensions			Spare Parts (Clips)
				Length	Diameter	Clip Centers	
3.6CAV2	2	3.6kV	50kA	8.66 (220)	1.63 (41.3)	7.46 (189.48)	1A0835
3.6ABWNA3.15	3.15	3.6kV	50kA	5.6 (142.2)	1 (25.4)	4.42 (112.2)	A3354705
3.6ABWNA6.3	3.15	3.6kV	50kA	5.6 (142.2)	1 (25.4)	4.42 (112.2)	A3354705
3.6ABCNA3.15	3.15	3.6kV	50kA	7.69 (195.3)	1 (25.4)	6.51 (165.3)	A3354705
3.6ABCNA6.3	6.3	3.6kV	50kA	7.69 (195.3)	1 (25.4)	6.51 (165.3)	A3354705
3.6ABCNA10	10	3.6kV	50kA	7.69 (195.3)	1 (25.4)	6.51 (165.3)	A3354705

5.5kV; E-Rated PT Fuse; Indicating & Non-indicating

Catalog Number	Amp Rating	Rated Voltage	IR RMS Sym.	Dimensions			Spare Parts (Clips)
				Length	Diameter	Clip Centers	
5.5CAVH0.5E	0.5	5.5kV	63kA	7.375 (187.3)	1.63 (41.3)	6.18 (156.84)	1A0835
5.5CAVH1E	1	5.5kV	63kA	7.375 (187.3)	1.63 (41.3)	6.18 (156.84)	1A0835
5.5CAVH2E	2	5.5kV	63kA	7.375 (187.3)	1.63 (41.3)	6.18 (156.84)	1A0835
5.5CAV15E	15	5.5kV	63kA	7.375 (187.3)	1.63 (41.3)	6.18 (156.84)	1A0835
5.5ABWNA0.5E	0.5	5.5kV	50kA	5.6 (142.2)	1 (25.4)	4.42 (112.2)	A3354705
5.5ABWNA1E	1	5.5kV	50kA	5.6 (142.2)	1 (25.4)	4.42 (112.2)	A3354705
5.5ABWNA2E	2	5.5kV	50kA	5.6 (142.2)	1 (25.4)	4.42 (112.2)	A3354705
5.5ABWNA3E	3	5.5kV	50kA	5.6 (142.2)	1 (25.4)	4.42 (112.2)	A3354705
5.5ABWNA5E	5	5.5kV	50kA	5.6 (142.2)	1 (25.4)	4.42 (112.2)	A3354705
5.5AMWNA0.5E	0.5	5.5kV	50kA	5.6 (142.2)	0.81 (20.6)	4.79 (121.6)	1A1837
5.5AMWNA1.0E	1	5.5kV	50kA	5.6 (142.2)	0.81 (20.6)	4.79 (121.6)	1A1837
5.5AMWNA2.0E	2	5.5kV	50kA	5.6 (142.2)	0.81 (20.6)	4.79 (121.6)	1A1837
5.5AMWNA3.0E	3	5.5kV	50kA	5.6 (142.2)	0.81 (20.6)	4.79 (121.6)	1A1837
5.5AMWNA4.0E	4	5.5kV	50kA	5.6 (142.2)	0.81 (20.6)	4.79 (121.6)	1A1837
5.5AMWNA5.0E	5	5.5kV	50kA	5.6 (142.2)	0.81 (20.6)	4.79 (121.6)	1A1837

Type CAVH are fitted with a striker pin for indication

7.2kV; E-Rated PT Fuse; Non-indicating

Catalog Number	Amp Rating	Rated Voltage	IR RMS Sym.	Dimensions			Spare Parts (Clips)
				Length	Diameter	Clip Centers	
7.2CAV2	2	7.2kV	63kA	8.66 (220)	1.63 (41.3)	7.46 (189.48)	1A0835
7.2CAV4	4	7.2kV	63kA	8.66 (220)	1.63 (41.3)	7.46 (189.48)	1A0835
7.2CAV6	6	7.2kV	63kA	8.66 (220)	1.63 (41.3)	7.46 (189.48)	1A0835
7.2CAV10	10	7.2kV	63kA	8.66 (220)	1.63 (41.3)	7.46 (189.48)	1A0835
7.2ABWNA3.15	3.15	7.2kV	45kA	5.6 (142.2)	1 (25.4)	4.42 (112.2)	A3354705
7.2ABWNA6.3	6.3	7.2kV	45kA	5.6 (142.2)	1 (25.4)	4.42 (112.2)	A3354705
7.2ABCNA3.15	3.15	7.2kV	45kA	7.69 (195.3)	1 (25.4)	6.51 (165.3)	A3354705
7.2ABCNA6.3	6.3	7.2kV	45kA	7.69 (195.3)	1 (25.4)	6.51 (165.3)	A3354705
7.2AMWNA0.5E	0.5	7.2kV	50kA	5.6 (142.2)	0.81 (20.6)	4.79 (121.6)	1A1837
7.2AMWNA1.0E	1	7.2kV	50kA	5.6 (142.2)	0.81 (20.6)	4.79 (121.6)	1A1837
7.2AMWNA2.0E	2	7.2kV	50kA	5.6 (142.2)	0.81 (20.6)	4.79 (121.6)	1A1837
7.2AMWNA3.0E	3	7.2kV	50kA	5.6 (142.2)	0.81 (20.6)	4.79 (121.6)	1A1837
7.2AMWNA4.0E	4	7.2kV	50kA	5.6 (142.2)	0.81 (20.6)	4.79 (121.6)	1A1837
7.2AMWNA5.0E	5	7.2kV	50kA	5.6 (142.2)	0.81 (20.6)	4.79 (121.6)	1A1837

E-Rated Fuses for Potential & Small Power Transformers

Dimension Illustration

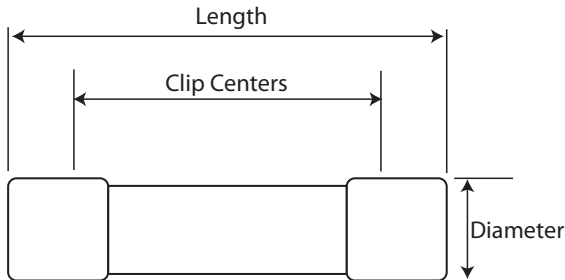

Catalog Numbers: E-Rated PT Fuses, Indicating & Non-Indicating

12kV; E-Rated PT Fuse; Non-indicating

Catalog Number	Amp Rating	Rated Voltage	IR RMS Sym.	Dimensions			Spare Parts (Clips)
				Length	Diameter	Clip Centers	
12CAV2	2	12kV	40kA	8.66 (220)	1.63 (41.3)	7.46 (189.48)	1A0835
12ABCNA3.15	3.15	12kV	45kA	7.69 (195.3)	1 (25.4)	6.51 (165.3)	A3354705

15.5kV; E-Rated PT Fuse; Indicating & Non-indicating

Catalog Number	Amp Rating	Rated Voltage	IR RMS Sym.	Dimensions			Spare Parts (Clips)
				Length	Diameter	Clip Centers	
15.5CAV(H)0.5E	0.5	15.5kV	80kA	12.87 (326.9)	1.63 (41.3)	1.2 (30.5)	1A0835
15.5CAV(H)1E	1	15.5kV	80kA	12.87 (326.9)	1.63 (41.3)	1.2 (30.5)	1A0835
15.5CAV(H)2E	2	15.5kV	80kA	12.87 (326.9)	1.63 (41.3)	1.2 (30.5)	1A0835
15.5CAV3E	3	15.5kV	80kA	12.87 (326.9)	1.63 (41.3)	1.2 (30.5)	1A0835
15.5CAV5E	5	15.5kV	80kA	12.87 (326.9)	1.63 (41.3)	1.2 (30.5)	1A0835
15.5CAV7E	7	15.5kV	80kA	12.87 (326.9)	1.63 (41.3)	1.2 (30.5)	1A0835

Type CAVH are fitted with a striker pin for indication

17.5kV; E-Rated PT Fuse; Non-indicating

Catalog Number	Amp Rating	Rated Voltage	IR RMS Sym.	Dimensions			Spare Parts (Clips)
				Length	Diameter	Clip Centers	
17.5CAV2	2	17.5kV	40kA	8.66 (220)	1.63 (41.3)	7.46 (189.48)	1A0835
17.5CAV4	4	17.5kV	40kA	8.66 (220)	1.63 (41.3)	7.46 (189.48)	1A0835
17.5CAV6	6	17.5kV	40kA	8.66 (220)	1.63 (41.3)	7.46 (189.48)	1A0835
17.5CAV10	10	17.5kV	40kA	8.66 (220)	1.63 (41.3)	7.46 (189.48)	1A0835
17.5ABGNA3.15	3.15	17.5kV	35kA	14.13 (358.9)	1 (25.4)	12.95 (328.9)	A3354705

24kV; E-Rated PT Fuse; Non-indicating

Catalog Number	Amp Rating	Rated Voltage	IR RMS Sym.	Dimensions			Spare Parts (Clips)
				Length	Diameter	Clip Centers	
24CAV2	2	24kV	40kA	13.39 (340.1)	1.63 (41.3)	12.19 (309.62)	1A0835
24CAV3	3	24kV	40kA	13.39 (340.1)	1.63 (41.3)	12.19 (309.62)	1A0835
24CAV4	4	24kV	40kA	13.39 (340.1)	1.63 (41.3)	12.19 (309.62)	1A0835
24ABGNA3.15	3.15	24kV	25kA	14.13 (358.9)	1 (25.4)	12.95 (328.9)	A3354705

36kV; E-Rated PT Fuse; Non-indicating

Catalog Number	Amp Rating	Rated Voltage	IR RMS Sym.	Dimensions			Spare Parts (Clips)
				Length	Diameter	Clip Centers	
36CAV2	2	36kV	40kA	17.32 (439.9)	1.63 (41.3)	16.12 (409.44)	1A0835
36CAV4	4	36kV	40kA	17.32 (439.9)	1.63 (41.3)	16.12 (409.44)	1A0835
36ABGNA3.15	3.15	36kV	31.5kA	14.13 (358.9)	1 (25.4)	12.95 (328.9)	A3354705

38kV; E-Rated PT Fuse; Indicating & Non-indicating

Catalog Number	Amp Rating	Rated Voltage	IR RMS Sym.	Dimensions			Spare Parts (Clips)
				Length	Diameter	Clip Centers	
38CAVH0.5E	0.5	38kV	40kA	17.32 (439.9)	1.63 (41.3)	16.12 (409.44)	1A0835
38CAVH1E	1	38kV	40kA	17.32 (439.9)	1.63 (41.3)	16.12 (409.44)	1A0835
38CAVH2E	2	38kV	40kA	17.32 (439.9)	1.63 (41.3)	16.12 (409.44)	1A0835
38CAV4E	4	38kV	40kA	17.32 (439.9)	1.63 (41.3)	16.12 (409.44)	1A0835

E-Rated, PT Fuses for Potential & Small Power Transformers

JCD, JCW, JCQ, JCI & JCT

Specifications

Description: Indicating and non-indicating E-rated medium voltage, current-limiting fuses for potential and small power transformers.

Dimensions: See Catalog Numbers table.

Construction: Plated ferrules.

Ratings:

Volts: — 2.4-15.5kV (See Catalog Numbers table for details)

Amps: — ½-10A

IR: — 25-80kA Sym

— 40-130kA ASYM

— See Catalog Numbers table for details



Features and Benefits

- Sized for retrofitting in existing hardware
- Space saving size

Typical Applications

- Primary protection of medium voltage potential transformers
- Primary protection of small medium voltage service transformers
- Primary protection of small medium voltage control transformers

2.4kV; E-Rated PT Fuse; Non-indicating

Catalog Number	Amp Rating	Rated Voltage	IR RMS Sym.	Dimensions			Spare Parts (Clips)
				Length	Diameter	Clip Centers	
JCD-1-2E	0.5	2.4kV	63kA	4.49 (114)	0.8 (20)	3.86 (98)	1A1837
JCD-1E	1	2.4kV	40kA	4.49 (114)	0.8 (20)	3.86 (98)	1A1837
JCD-2E	2	2.4kV	40kA	4.49 (114)	0.8 (20)	3.86 (98)	1A1837
JCD-5E	5	2.4kV	25kA	4.49 (114)	0.8 (20)	3.86 (98)	1A1837

2.4/5.5kV; E-Rated PT Fuse; Non-indicating

Catalog Number	Amp Rating	Rated Voltage	IR RMS Sym.	Dimensions			Spare Parts (Clips)
				Length	Diameter	Clip Centers	
JCW-1/2E	0.5	2.4kV/5.5kV	40kA	7.31 (185)	1.56 (39.7)	5.93 (150.6)	1A0835
JCW-1E	1	2.4kV/5.5kV	40kA	7.31 (185)	1.56 (39.7)	5.93 (150.6)	1A0835
JCW-2E	2	2.4kV/5.5kV	40kA	7.31 (185)	1.56 (39.7)	5.93 (150.6)	1A0835
JCW-3E	3	2.4kV/5.5kV	40kA	7.31 (185)	1.56 (39.7)	5.93 (150.6)	1A0835
JCW-4E	4	2.4kV/5.5kV	40kA	7.31 (185)	1.56 (39.7)	5.93 (150.6)	1A0835
JCW-5E	5	2.4kV/5.5kV	40kA	7.31 (185)	1.56 (39.7)	5.93 (150.6)	1A0835

5.5kV; E-Rated PT Fuse; Indicating

Catalog Number	Amp Rating	Rated Voltage	IR RMS Sym.	Dimensions			Spare Parts (Clips)
				Length	Diameter	Clip Centers	
JCQ-3E	3	5.5kV	130kA	9.5 (241.3)	1.6 (40.6)	8.12 (206)	1A0835
JCQ-5E	5	5.5kV	130kA	9.5 (241.3)	1.6 (40.6)	8.12 (206)	1A0835
JCQ-10E	10	5.5kV	130kA	9.5 (241.3)	1.6 (40.6)	8.12 (206)	1A0835

8.3kV; E-Rated PT Fuse; Indicating

Catalog Number	Amp Rating	Rated Voltage	IR RMS Sym.	Dimensions			Spare Parts (Clips)
				Length	Diameter	Clip Centers	
JCI-3E	3	8.3kV	80kA	12.88 (327)	1.6 (40.6)	11.5 (292)	1A0835
JCI-5E	5	8.3kV	80kA	12.88 (327)	1.6 (40.6)	11.5 (292)	1A0835
JCI-10E	10	8.3kV	80kA	12.88 (327)	1.6 (40.6)	11.5 (292)	1A0835

15.5kV; E-Rated PT Fuse; Indicating

Catalog Number	Amp Rating	Rated Voltage	IR RMS Sym.	Dimensions			Spare Parts (Clips)
				Length	Diameter	Clip Centers	
JCT-3E	3	15.5kV	80kA	17.5 (444.5)	1.6 (40.6)	16.12 (409.4)	1A0835
JCT-5E	5	15.5kV	80kA	17.5 (444.5)	1.6 (40.6)	16.12 (409.4)	1A0835
JCT-10E	10	15.5kV	80kA	17.5 (444.5)	1.6 (40.6)	16.12 (409.4)	1A0835

PT Fuses

**HVA, HVB,
HVJ, HVL,
HVR, HVT,
HVU, HVW &
HVX**

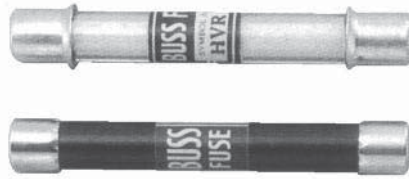

Specifications

Description: Medium voltage, non-time delay, fast-acting fuses.

Dimensions: See Basic Catalog Numbers table.

Ratings:

Volts: — 1-10kV (See Basic Catalog Numbers table)

Amps: — 1/6-10A (See Basic Catalog Numbers table)

Features and Benefits

- Physical size varies with electrical rating of fuse to prevent over-fusing.
- Space saving size.

Typical Applications

- Medium Voltage Instrument Protection
- Medium Voltage Circuit Protection

Test Specifications

Basic Catalog Numbers	Load / Opening Time
HVA, HVB, HVJ, HVL	110% / 4 Hours (min) 135% / 1 Hour (max)
HVR, HVT, HVU, HVW, HVX	100% / 4 Hours (min) 150% / 1 Hour (max)

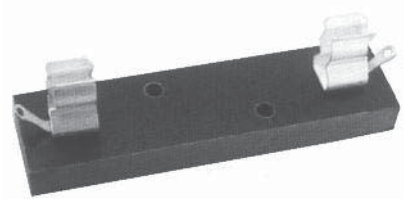

Fuse blocks: 4528, 4529

Voltage Rating: 1000 to 10,000V

Basic Catalog Numbers	Fuse Block Catalog Number	Fuse Clip Catalog Number
HVA, HVR	4528	5960
HVB, HVT	4529	5960
HVJ, HVU	N/A	4180
HVL, HVX	N/A	4180

Use #8 screws on blocks 4528 and 4529.

Basic Catalog Number	kV	Amp Ratings	Maximum S.C.	Dimensions - in (mm)	
				Diameter	Length
HVA	1	1/6, 1/10, 1/8, 3/10, 1/4, 3/10, 3/8, 1/2, 3/4, 1, 1 1/2, 2, 3, 4, 6, 10	20kW DC/30kVA AC	0.41 (10.4)	3 (76.1)
HVB	2.5	1/2, 3/4, 1, 1 1/2, 2, 3	20kW DC/30kVA AC	0.41 (10.4)	4.5 (114.2)
HVJ	5	1/6, 1/8, 1/4, 1/2, 3/4, 1, 1 1/2, 2, 4, 6, 10	20kW DC/30kVA AC	0.81 (20.6)	5 (126.9)
HVL	10	1/6, 1/8, 1/4, 1/2, 1, 1 1/2, 2, 3	20kW DC/30kVA AC	0.81 (20.6)	10 (254)
HVR	1	1/2, 1, 2, 3, 4, 5	kVA-500 AC only	0.41 (10.4)	3 (76.2)
HVW	1.2	1, 2, 3, 4, 5, 8	kVA-12,000 AC only	0.41 (10.4)	2.25 (57.1)
HVT	2.5	1/2, 1, 2, 3, 5	kVA-1250 AC only	0.41 (10.4)	4.5 (114.2)
HVU	5	1/2, 1, 2, 3, 4, 5	kVA-2500 AC only	0.81 (20.6)	5 (126.9)
HVX	10	1/2, 1, 3, 5	kVA-5,000 AC only	0.41 (10.4)	10.0 (253.8)

Catalog Number Build-A-Code

Basic Catalog Number Amps

--- ---

R-Rated Fuses for Motor Circuit Protection

**JCG, JCH, JCK,
JCK-A, JCK-B, JCL,
JCL-A, JCL-B, JCR-A,
& JCR-B**

Specifications

Description: Indoor/enclosure R-Rated medium voltage, current-limiting fuses for motor circuit protection.

Dimensions: See Dimensions illustrations.

Ratings:

- Volts: — 2.4-7.2kV (See Catalog Numbers table for details)
- Amps: — 25-450A (See Catalog Numbers table for details)
- IR: — 50kA Sym
- 80kA ASYM
- See Catalog Numbers table for details



Agency Information: UL Recognized: 2540Vac — JCK, JCK-A, 5080Vac — JCL, JCL-A, UL Recognized (Guide #MSSS2, File #E96676).

Features and Benefits

- Physically dimensioned for retrofitting in existing hardware
- Open fuse indicator for ease in troubleshooting
- Available with optional Cutler Hammer® hookeye for ease of insertion and removal
- Classified as back-up fuses for current-limited protection of medium voltage motor controllers

Typical Applications

- Medium Voltage Motor Controllers

Dimensions - mm (in)

Figure 1

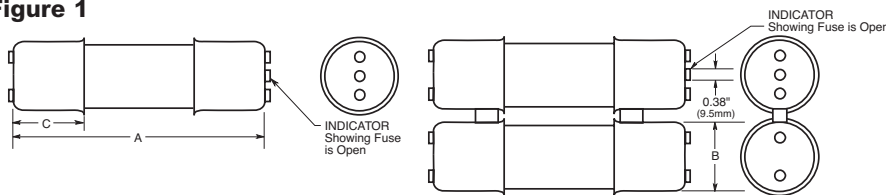

Figure 2

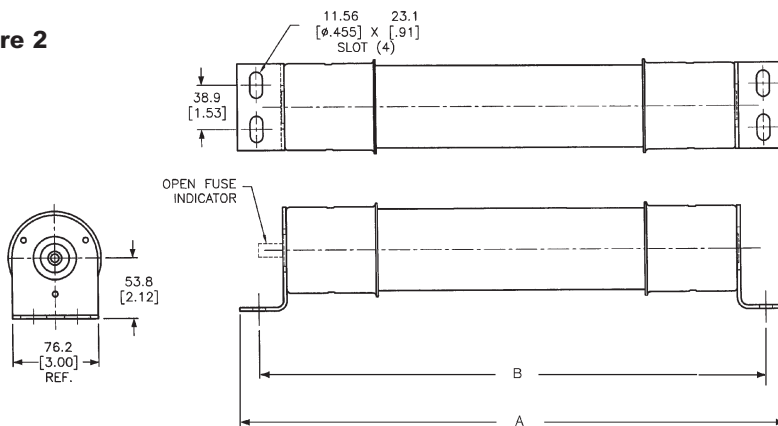
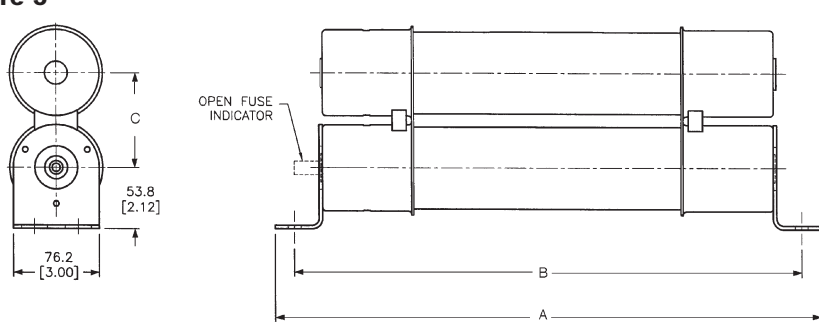

Figure 3



R-Rated Fuses for Motor Circuit Protection

Catalog Numbers: R-Rated; Indoor/Enclosure

Catalog Numbers	Amp Ratings	Maximum Design Voltage	Dimensions - in (mm)*			Construction	Max Int. Cap. Amps (Asym.)	Amps (Sym.)	Min Int. Cap. Amps (Sym.)
			A	B	C				
2400V (See Figure 1)									
JCK-2R	70	2540	11.24 (285.5)	3.0 (76.2)	3.0 (76.2)	Single	80,000	50,000	165
JCK-3R	100	2540	11.24 (285.5)	3.0 (76.2)	3.0 (76.2)	Single	80,000	50,000	220
JCK-4R	130	2540	11.24 (285.5)	3.0 (76.2)	3.0 (76.2)	Single	80,000	50,000	320
JCK-5R	150	2540	11.24 (285.5)	3.0 (76.2)	3.0 (76.2)	Single	80,000	50,000	410
JCK-6R	170	2540	11.24 (285.5)	3.0 (76.2)	3.0 (76.2)	Single	80,000	50,000	480
JCK-9R	200	2540	11.24 (285.5)	3.0 (76.2)	3.0 (76.2)	Single	80,000	50,000	720
JCK-12R	230	2540	11.24 (285.5)	3.0 (76.2)	3.0 (76.2)	Single	80,000	50,000	970
JCK-18R	390	2540	11.24 (285.5)	3.0 (76.2)	3.0 (76.2)	Double	80,000	50,000	1,430
JCK-24R	450	2540	11.24 (285.5)	3.0 (76.2)	3.0 (76.2)	Double	80,000	50,000	1,880

2400V — With Westinghouse Ampguard Hookeye (See Figure 1)

JCK-A-2R	70	2540	11.24 (285.5)	3.0 (76.2)	3.0 (76.2)	Single	80,000	50,000	165
JCK-A-3R	100	2540	11.24 (285.5)	3.0 (76.2)	3.0 (76.2)	Single	80,000	50,000	220
JCK-A-4R	130	2540	11.24 (285.5)	3.0 (76.2)	3.0 (76.2)	Single	80,000	50,000	320
JCK-A-5R	150	2540	11.24 (285.5)	3.0 (76.2)	3.0 (76.2)	Single	80,000	50,000	410
JCK-A-6R	170	2540	11.24 (285.5)	3.0 (76.2)	3.0 (76.2)	Single	80,000	50,000	480
JCK-A-9R	200	2540	11.24 (285.5)	3.0 (76.2)	3.0 (76.2)	Single	80,000	50,000	720
JCK-A-12R	230	2540	11.24 (285.5)	3.0 (76.2)	3.0 (76.2)	Single	80,000	50,000	970
JCK-A-18R	390	2540	11.24 (285.5)	3.0 (76.2)	3.0 (76.2)	Double	80,000	50,000	1,430
JCK-A-24R	450	2540	11.24 (285.5)	3.0 (76.2)	3.0 (76.2)	Double	80,000	50,000	1,880

2400V — Bolt-On (See Figures 2 & 3)

JCK-B-30	25	2540	14.18 (360.2)	12.81 (325.4)	-	Single	80,000	50,000	90
JCK-B-2R	70	2540	14.18 (360.2)	12.81 (325.4)	-	Single	80,000	50,000	170
JCK-B-3R	100	2540	14.18 (360.2)	12.81 (325.4)	-	Single	80,000	50,000	245
JCK-B-4R	130	2540	14.18 (360.2)	12.81 (325.4)	-	Single	80,000	50,000	340
JCK-B-5R	150	2540	14.18 (360.2)	12.81 (325.4)	-	Single	80,000	50,000	430
JCK-B-6R	170	2540	14.18 (360.2)	12.81 (325.4)	-	Single	80,000	50,000	500
JCK-B-9R	200	2540	14.18 (360.2)	12.81 (325.4)	-	Single	80,000	50,000	1,000
JCK-B-12R	230	2540	14.18 (360.2)	12.81 (325.4)	-	Single	80,000	50,000	1,250
JCK-B-18R	390	2540	14.18 (360.2)	12.81 (325.4)	3.56 (90.4)	Double	80,000	50,000	1,700
JCK-B-24R	450	2540	14.18 (360.2)	12.81 (325.4)	3.56 (90.4)	Double	80,000	50,000	1,210

2400V — Hermetically Sealed, For Use with Ampguard Motor Starters (See Figure 1)

JCH-30	25	2540	10.81 (275.6)	3.0 (76.2)	3.0 (76.2)	Single	80,000	50,000	90
JCH-2R	70	2540	10.81 (275.6)	3.0 (76.2)	3.0 (76.2)	Single	80,000	50,000	170
JCH-3R	100	2540	10.81 (275.6)	3.0 (76.2)	3.0 (76.2)	Single	80,000	50,000	245
JCH-4R	130	2540	10.81 (275.6)	3.0 (76.2)	3.0 (76.2)	Single	80,000	50,000	340
JCH-5R	150	2540	10.81 (275.6)	3.0 (76.2)	3.0 (76.2)	Single	80,000	50,000	430
JCH-6R	170	2540	10.81 (275.6)	3.0 (76.2)	3.0 (76.2)	Single	80,000	50,000	500
JCH-9R	200	2540	10.81 (275.6)	3.0 (76.2)	3.0 (76.2)	Single	80,000	50,000	1,000
JCH-12R	230	2540	10.81 (275.6)	3.0 (76.2)	3.0 (76.2)	Single	80,000	50,000	1,250
JCH-18R	390	2540	10.81 (275.6)	3.0 (76.2)	3.0 (76.2)	Double	80,000	50,000	1,700
JCH-24R	450	2540	10.81 (275.6)	3.0 (76.2)	3.0 (76.2)	Double	80,000	50,000	2,100

4800V (See Figure 1)

JCL-2R	70	5080	15.76 (400.3)	3.0 (76.2)	3.0 (76.2)	Single	80,000	50,000	165
JCL-3R	100	5080	15.76 (400.3)	3.0 (76.2)	3.0 (76.2)	Single	80,000	50,000	220
JCL-4R	130	5080	15.76 (400.3)	3.0 (76.2)	3.0 (76.2)	Single	80,000	50,000	320
JCL-5R	150	5080	15.76 (400.3)	3.0 (76.2)	3.0 (76.2)	Single	80,000	50,000	410
JCL-6R	170	5080	15.76 (400.3)	3.0 (76.2)	3.0 (76.2)	Single	80,000	50,000	480
JCL-9R	200	5080	15.76 (400.3)	3.0 (76.2)	3.0 (76.2)	Single	80,000	50,000	720
JCL-12R	230	5080	15.76 (400.3)	3.0 (76.2)	3.0 (76.2)	Single	80,000	50,000	970
JCL-18R	390	5080	15.76 (400.3)	3.0 (76.2)	3.0 (76.2)	Double	80,000	50,000	1,430
JCL-24R	450	5080	15.76 (400.3)	3.0 (76.2)	3.0 (76.2)	Double	80,000	50,000	1,880

* See previous page Figure 2 for single construction and Figure 3 for double construction information.
Recommended fuseclips: see page 120 - 1A0065, A3354730, 9078A67G04.

R-Rated Fuses for Motor Circuit Protection

Catalog Numbers: R-Rated; Indoor/Enclosure

Catalog Numbers	Amp Ratings	Maximum Design Voltage	Dimensions - in (mm)			Construction	Max Int. Cap. Amps (Asym.)	Amps (Sym.)	Min Int. Cap. Amps (Sym.)
			A	B	C				
4800V — With Westinghouse Ampguard Hookey (See Figure 1)									
JCL-A-2R	70	5080	15.76 (400.3)	3.0 (76.2)	3.0 (76.2)	Single	80,000	50,000	165
JCL-A-3R	100	5080	15.76 (400.3)	3.0 (76.2)	3.0 (76.2)	Single	80,000	50,000	220
JCL-A-4R	130	5080	15.76 (400.3)	3.0 (76.2)	3.0 (76.2)	Single	80,000	50,000	320
JCL-A-5R	150	5080	15.76 (400.3)	3.0 (76.2)	3.0 (76.2)	Single	80,000	50,000	410
JCL-A-6R	170	5080	15.76 (400.3)	3.0 (76.2)	3.0 (76.2)	Single	80,000	50,000	480
JCL-A-9R	200	5080	15.76 (400.3)	3.0 (76.2)	3.0 (76.2)	Single	80,000	50,000	720
JCL-A-12R	230	5080	15.76 (400.3)	3.0 (76.2)	3.0 (76.2)	Single	80,000	50,000	970
JCL-A-18R	390	5080	15.76 (400.3)	3.0 (76.2)	3.0 (76.2)	Double	80,000	50,000	1,430
JCL-A-24R	450	5080	15.76 (400.3)	3.0 (76.2)	3.0 (76.2)	Double	80,000	50,000	1,880

4800V — Bolt-On (See Figures 2 & 3)

JCL-B-30	30	5080	19.25 (488.9)	17.88 (454.1)	-	Single	80,000	50,000	95
JCL-B-2R	70	5080	19.25 (488.9)	17.88 (454.1)	-	Single	80,000	50,000	180
JCL-B-3R	100	5080	19.25 (488.9)	17.88 (454.1)	-	Single	80,000	50,000	270
JCL-B-4R	130	5080	19.25 (488.9)	17.88 (454.1)	-	Single	80,000	50,000	350
JCL-B-5R	150	5080	19.25 (488.9)	17.88 (454.1)	-	Single	80,000	50,000	450
JCL-B-6R	170	5080	19.25 (488.9)	17.88 (454.1)	-	Single	80,000	50,000	540
JCL-B-9R	200	5080	19.25 (488.9)	17.88 (454.1)	-	Single	80,000	50,000	700
JCL-B-12R	230	5080	19.25 (488.9)	17.88 (454.1)	-	Single	80,000	50,000	1,000
JCL-B-18R	390	5080	19.25 (488.9)	17.88 (454.1)	3.31 (84.1)	Double	80,000	50,000	1,450
JCL-B-24R	450	5080	19.25 (488.9)	17.88 (454.1)	3.31 (84.1)	Double	80,000	50,000	2,000

4800V — Hermetically Sealed, For Use with Ampguard Motor Starters (See Figure 1)

JCG-30	30	5080	15.91 (404.1)	3.0 (76.2)	3.0 (76.2)	Single	80,000	50,000	95
JCG-2R	70	5080	15.91 (404.1)	3.0 (76.2)	3.0 (76.2)	Single	80,000	50,000	180
JCG-3R	100	5080	15.91 (404.1)	3.0 (76.2)	3.0 (76.2)	Single	80,000	50,000	270
JCG-4R	130	5080	15.91 (404.1)	3.0 (76.2)	3.0 (76.2)	Single	80,000	50,000	350
JCG-5R	150	5080	15.91 (404.1)	3.0 (76.2)	3.0 (76.2)	Single	80,000	50,000	450
JCG-6R	170	5080	15.91 (404.1)	3.0 (76.2)	3.0 (76.2)	Single	80,000	50,000	540
JCG-9R	200	5080	15.91 (404.1)	3.0 (76.2)	3.0 (76.2)	Single	80,000	50,000	700
JCG-12R	230	5080	15.91 (404.1)	3.0 (76.2)	3.0 (76.2)	Single	80,000	50,000	1,000
JCG-A-18R	390	5080	15.91 (404.1)	3.0 (76.2)	3.0 (76.2)	Double	80,000	50,000	1,450
JCG-A-24R	450	5080	15.91 (404.1)	3.0 (76.2)	3.0 (76.2)	Double	80,000	50,000	2,000

7200V — With Ampguard Hookey (See Figure 1)

JCR-A-2R	70	8300	15.85 (402.6)	3.0 (76.2)	3.0 (76.2)	Single	80,000	50,000	160
JCR-A-3R	100	8300	15.85 (402.6)	3.0 (76.2)	3.0 (76.2)	Single	80,000	50,000	250
JCR-A-4R	130	8300	15.85 (402.6)	3.0 (76.2)	3.0 (76.2)	Single	80,000	50,000	325
JCR-A-5R	150	8300	15.85 (402.6)	3.0 (76.2)	3.0 (76.2)	Single	80,000	50,000	390
JCR-A-6R	170	8300	15.85 (402.6)	3.0 (76.2)	3.0 (76.2)	Single	80,000	50,000	500
JCR-A-9R	200	7200	15.85 (402.6)	3.0 (76.2)	3.0 (76.2)	Single	80,000	50,000	750
JCR-A-12R	230	7200	15.85 (402.6)	3.0 (76.2)	3.0 (76.2)	Single	80,000	50,000	1,000
JCR-A-18R	390	7200	15.85 (402.6)	3.0 (76.2)	3.0 (76.2)	Double	80,000	50,000	1,450
JCR-A-24R	450	7200	15.85 (402.6)	3.0 (76.2)	3.0 (76.2)	Double	80,000	50,000	2,500

7200V — Bolt-On (See Figures 2 & 3)

JCR-B-2R	70	8300	19.25 (488.9)	17.88 (454.1)	-	Single	80,000	50,000	160
JCR-B-3R	100	8300	19.25 (488.9)	17.88 (454.1)	-	Single	80,000	50,000	250
JCR-B-4R	130	8300	19.25 (488.9)	17.88 (454.1)	-	Single	80,000	50,000	325
JCR-B-5R	150	8300	19.25 (488.9)	17.88 (454.1)	-	Single	80,000	50,000	390
JCR-B-6R	170	8300	19.25 (488.9)	17.88 (454.1)	-	Single	80,000	50,000	500
JCR-B-9R	200	7200	19.25 (488.9)	17.88 (454.1)	-	Single	80,000	50,000	750
JCR-B-12R	230	7200	19.25 (488.9)	17.88 (454.1)	-	Single	80,000	50,000	1,000
JCR-B-18R	390	7200	19.25 (488.9)	17.88 (454.1)	3.31 (84.1)	Double	80,000	50,000	1,450
JCR-B-24R	450	7200	19.25 (488.9)	17.88 (454.1)	3.31 (84.1)	Double	80,000	50,000	2,500

Recommended fuseclips: see page 120 - 1A0065, A3354730, 9078A67G04.

British Standard Dimensioned IEC Fuses for Motor Circuit Protection

The Bussmann range of motor fuses are designed to meet the specific requirements necessary for motor protection. During the starting cycle of direct on-line motors, the fuse elements will reach a considerably higher temperature than during normal operation; (this is due to the high amount of current the motor will draw as it starts, typically, six times its normal load current value). This results in expansion and contraction of the fuse elements and could cause premature operation of the fuse.

Bussmann motor fuses encompass an advanced design to minimize this effect. This therefore, negates the need to over specify the fuse rating due to high values of motor starting current.

Bussmann motor fuses operate extremely quickly under heavy fault currents, resulting from the time / current characteristic. Low power dissipation ensures low temperature rise, important in multi-tier starters for example. Switching (arc), voltages are lower than permitted values, therefore, 5.5kV fuses are also suitable for 4.8kV and 2.4kV circuits.

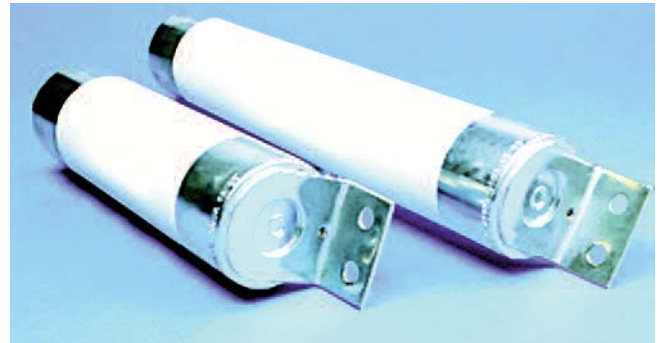

Table of Ratings

Basic Cat. Number	Volts	Breaking Capacity	Amp Ratings	Dimensions - in (mm)		Dimensional Standard
				Length	Diameter	
3.6WJON6	3.6kV	50kA	5, 6.3, 10, 16, 20, 25, 31.5, 40, 50	7.56 (192)	1.4 (35.6)	BS 2692 (TA1) Interchangeable with GEC Type K2 PA
3.6WDOH6	3.6kV	50kA	50, 63, 80, 100, 125	7.56 (192)	2 (50.8)	BS 2692 (TA1) or DIN 43625
3.6WFOH6	3.6kV	50kA	160, 200	7.56 (192)	3 (76.2)	BS 2692 (TA1) or DIN 43625
3.6WDLSJ	3.6kV	50kA	50, 63, 80, 100, 125	11.5 (292.1)	2 (50.8)	DIN 43625
3.6WFLSJ	3.6kV	50kA	160, 200	11.5 (292.1)	3 (76.2)	DIN 43625
3.6WDFHO	3.6kV	50kA	50, 63, 80, 100, 125	10 (254)	2 (51)	BS 2692 (TA2)
3.6WFFHO	3.6kV	50kA	160, 200	10 (254)	3 (76.2)	BS 2692 (TA2)
3.6WKFHO	3.6kV	50kA	250, 315, 355, 400	10 (254)	3 (76.2)	BS 2692 (TA2)
5.5VFNHA	5.5kV	60kA	2R-6R	15.86 (402.8)	3 (76.2)	ANSI R-Rated
5.5VKNHA	5.5kV	60kA	9R-24R	15.86 (402.8)	3 (76.2)	ANSI R-Rated
7.2WFNHO	7.2kV	40kA	25, 31.5, 40, 50, 63, 80, 100, 125, 160	15.86 (402.8)	3 (76.2)	BS 2692 (TA4)
7.2WKNHO	7.2kV	40kA	200, 224, 250, 315	15.86 (402.8)	3 (76.2)	BS 2692 (TA4)
7.2WFMSJ	7.2kV	63kA	25, 31.5, 40, 50, 63, 80, 125, 160	17.40 (442)	3 (76.2)	DIN 43625
7.2WKMSJ	7.2kV	63kA	200, 224, 250, 315, 355	17.40 (442)	3 (76.2)	DIN 43625

Catalog Number Build-A-Code

kV Basic Catalog Number Amps
 --- --- ---

Medium Voltage Fuses

DIN Dimensioned IEC Fuses for Transformer Protection

DIN Dimension Fuses

To Spec. DIN 43625



Specifications

Catalog Symbol: See Basic Catalog Numbers table.

Description: DIN dimension fuses to Specification DIN 43625 covering current-limiting fuses with performance in compliance with IEC 60282-1. These are in accordance with the R10 and, in some cases, the R20 series of preferred numbers.

Dimensions: See Catalog Numbers table.

Volts: — See voltage associated with the Basic Catalog Numbers in the table.

Amps: — See amp rating associated with the Basic Catalog Numbers in the table.

IR: — See IR associated with the Basic Catalog Numbers in the table.

Agency Information: Comply with DIN dimensional standard DIN 43625, VDE 0670 part 4, VDE 0670 part 40Z and with IEC 60282-1 (2005).

Features and Benefits

- DIN dimensioned for retrofitting in existing hardware
- Open fuse indicator for ease in troubleshooting
- Designed for use in IEC equipment

Typical Applications

- Medium Voltage IEC designed equipment

Catalog Number Build-A-Code

kV Basic Catalog Number Amps
 --- --- ---

Catalog Numbers

kV	Catalog Numbers	Amp Ratings	Dimensions - in (mm) Diameter x Length	IR RMS Sym
3.6	3.6AD0SJ(amp)	6.3, 10, 16, 20, 25, 31.5, 40	2.00 x 7.56 (51 x 192)	50kA
	3.6WD0SJ(amp)	50, 63, 80, 100, 125	2.00 x 7.56 (51 x 192)	
	3.6WF0SJ(amp)	160, 200	3.00 x 7.56 (76 x 192)	
	3.6ADLSJ(amp)	25, 40	2.00 x 11.50 (51 x 292)	
	3.6WDLSJ(amp)	50, 63, 80, 100, 125	2.00 x 11.50 (51 x 292)	
	3.6WFLSJ(amp)	160, 200	3.00 x 11.50 (76 x 292)	
	3.6WKLSJ(amp)	250, 315, 400	3.00 x 11.50 (76 x 292)	
7.2	7.2TDLSJ(amp)	6.3, 10, 16, 20, 25, 31.5, 40, 50, 63	2.00 x 11.50 (51 x 292)	40kA
	7.2TFLSJ(amp)	80, 100, 125, 160	3.00 x 11.50 (76 x 292)	
	7.2WKMSJ(amp)	200, 225, 250, 315, 355	3.00 x 17.41 (76 x 442)	
12	12TDLEJ(amp)	6.3, 10, 16, 20, 25, 31.5, 40, 50, 63	2.00 x 11.50 (51 x 292)	63kA
	12THLEJ(amp)	80, 100	2.52 x 11.50 (64 x 292)	
	12TKLEJ(amp)	125	3.00 x 11.50 (76 x 292)	
	12TXLEJ(amp)*	160, 200	3.50 x 11.50 (88 x 292)	
17.5	17.5TDLSJ(amp)*	6.3, 10, 16, 20, 25, 31.5, 40	2.00 x 11.50 (51 x 292)	35.5kA
	17.5TFLSJ(amp)*	50	3.00 x 11.50 (76 x 292)	
	17.5TDMEJ(amp)	6.3, 10, 16, 20, 25, 31.5, 40, 50, 63	2.00 x 17.41 (51 x 442)	50kA
	17.5THMEJ(amp)	80, 100	2.52 x 17.41 (64 x 442)	
	17.5TKMEJ(amp)	125	3.00 x 17.41 (76 x 442)	
24	24TDMEJ(amp)	6.3, 10, 16, 20, 25, 31.5, 40, 50	2.00 x 17.41 (51 x 442)	50kA
	24THMEJ(amp)	63	2.52 x 17.41 (64 x 442)	
	24TFMEJ(amp)	80, 100* ¹	3.00 x 17.41 (76 x 442)	31.5kA
	24TXMEJ(amp)*	125 ² , 160	3.46 x 17.41 (88 x 442)	
36	36TDQSJ(amp)	3.15 ³ , 6.3, 10, 16, 20, 25	2.00 x 21.16 (51 x 537)	35.5kA
	36TFQSJ(amp)	31.5, 40, 50	3.00 x 21.16 (76 x 537)	
	36TXQEJ(amp)*	63	3.46 x 21.16 (88 x 537)	20kA

Recommended fuseclips for DIN style fuses – 270303, A3354745 see page 120.

*Not compliant with VDE 0670, part 402.

¹-IR RMS Sym is 63kA

²-IR RMS Sym is 40kA

³-IR RMS Sym is 20kA

Dimensions - In (mm)

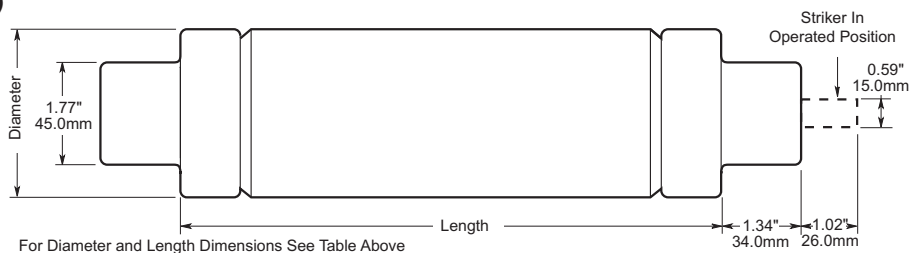

Expulsion Fuse Links for Use in High Voltage Distribution Cut-Outs

Specifications

Description: Expulsion fuse links available in a wide range of options from 15kV to 72kV in ANSI T&K characteristics.

Ratings:

Volts: — 15 to 72kV

Amps: — 1 to 100A

Breaking Capacity: depends on voltage but is approximately 8kA

Agency Information:

Type T: complies with ANSI C37-42

Type K: complies with ANSI C37-42

Features and Benefits

- Wide range of options available from 15kV to 72kV in ANSI T & K characteristics.
- Extra rapid option also available.

Packaging:

Up to and including 50A: 25 in a carton

From 60A to 100A: 10 in a carton

To avoid incorrect replacement the fuse links have colour coded labels:

Pink label: Type XA

Yellow label: Type K

Green label: Type T



Typical Applications:

- Primary side transformer protection
- Feeder protection
- Capacitor bank protection

Use of Application

Expulsion fuse links current ratings should be selected on the basis of maximum expected transient no damage currents rather than on full load current. In addition, the selection of higher current ratings will reduce the possibility of supply interruption due to transient surges such as those due to lightning strikes.

Links should be handled with a reasonable degree of care when installing. Excessively rough handling may damage the element.

It is normal, under certain fault conditions, for arc extinguishing material and/or metal particles to be expelled from the fuse assembly. It is therefore recommended that reasonable precautions be taken to prevent the installation being approached by unauthorised persons.

How to order - Parts Referencing System

Rated Voltage (kV)	1st Letter Type of Current Characteristics	2nd Letter Type of Termination	Rated Current (A)
15 25 46 72	<p>T = complies with ANSI C 37-42 requirements for slow acting T characteristics</p> <p>K = complies with ANSI C 37-42 requirements for fast acting K characteristics</p> <p>XA = this type of expulsion fuse link has an extra rapid characteristic. It is suitable for applications where a high degree of system protection is required at the expense of discrimination</p> <p>S = Solid links rated at 100A are also available in both button head and universal versions for fitting into expulsion fuse carriers where required. These can be ordered in a similar way using the abbreviation S, e.g. 15SB, etc</p>	<p>B = a fixed NEMA button head link</p> <p>U = a universal link, with double tail and slip off NEMA button head</p> <p>D = double tailed link without NEMA button head</p> <p>BR = as pattern B but the button head is attached via a 1/4 UNF thread to allow use of an extension rod.</p> <p>See outline drawings opposite page for reference</p>	1, 2, 3, 4, 5, 6, 7.5, 8, 10, 12, 15, 20, 25, 30, 40, 50, 60, 65, 75, 80, 100

Thus a typical ordering reference for a 15kV NEMA Type K, button head 30A fuse link would be 15KB30 expulsion fuse link.

The fuse link assembly for a given range is standard to all rated voltages. The exception is that the tail length is varied to suit the dimensions of expulsion carrier of different ratings.

Expulsion Fuse Links for Use in High Voltage Distribution Cut-Outs

Dimensions - mm (in)

Type kV	A
15kV	533 (21")
25kV	660 (26")
46kV	787 (31")
72kV	1016 (40")

Notes: Type BR is similar to button head shown, except that the button head is attached via a ¼ UNF thread. Tails can be cut to any length.

1-50A

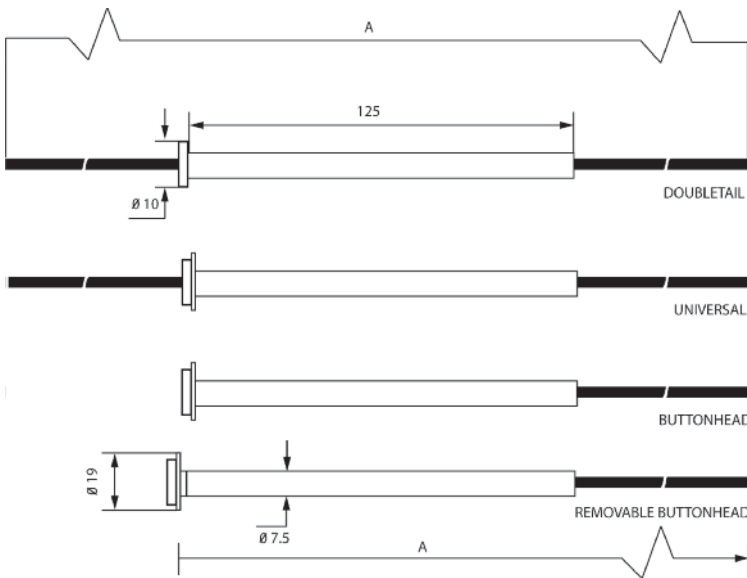

60-100A

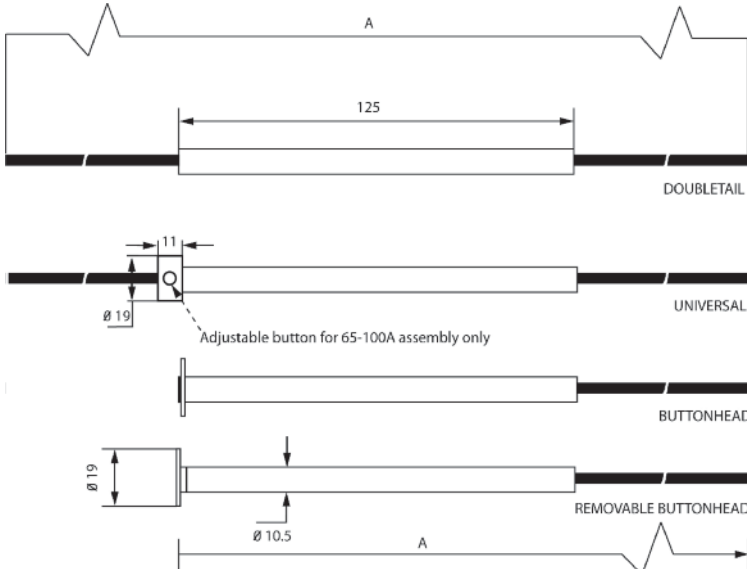

EEI-NEMA Type K & T and Type H & N

FL: Type H and EEI-NEMA Type K & T Fuses



Specifications

Description: Medium voltage fuses: Type H (high surge), EEI-NEMA Type K (fast-acting), EEI-NEMA Type T (slow-acting).

Ratings:

Amps: — 1-200A
(See Catalog Numbers tables)

Features and Benefits

- Wide range of EEI-NEMA type fuse links for use in open fuse cutouts
- Voltage ratings up to 27kV.
- Can be coordinated with other overcurrent protective devices for sectionalizing to isolate feeder branches.

Typical Applications

- Medium Voltage Fused Cutouts

High-Surge Type H Fuses

High-surge, Type H fuses are manufactured in ratings of 1, 2, 3, 5, and 8A. They have been developed principally for primary fusing of small-sized transformers. Type H links are manufactured in the universal buttonhead design.

Type N Fuses

Type N fuses conform to previous NEMA standards and have been superseded by Type K and T links. Type N fuses are manufactured in the universal button design in ratings of 5 through 200A for use in NEMA standard dimensioned cutouts rated through 27kV.

Catalog Numbers

EEI-NEMA and High-Surge Universal Tin Element

Fuses for Cutouts — Rated to 27kV

Non-Removable Button-Head For Standard Open or Enclosed Cutouts

Catalog Numbers			
Type H (High Surge)	EEI-NEMA Type K (Fast)	EEI-NEMA Type T (Slow)	Amps
FL11H1	FL11K1	FL11T1	1
FL11H2	FL11K2	FL11T2	2
FL11H3	FL11K3	FL11T3	3
FL11H5	FL11K5	FL11T5	5
—	FL11K6	FL11T6	6
FL11H8	FL11K8	FL11T8	8
—	FL11K10	FL11T10	10
—	FL11K12	FL11T12	12
—	FL11K15	FL11T15	15
—	FL11K20	FL11T20	20
—	FL11K25	FL11T25	25
—	FL11K30	FL11T30	30
—	FL11K40	FL11T40	40
—	FL11K50	FL11T50	50
—	FL11K65	FL11T65	65
—	FL11K80	FL11T80	80
—	FL11K100	FL11T100	100
—	FL11K140	FL11T140	140
—	FL11K200	FL11T200	200

Removable Button-Head For Cutouts Requiring Removable-Button Links

Catalog Numbers

EEI-NEMA Type K (Fast)	EEI-NEMA Type T (Slow)	Amps
FL3K1	FL3T1	1
FL3K2	FL3T2	2
FL3K3	FL3T3	3
FL3K5	FL3T5	5
FL3K6	FL3T6	6
FL3K8	FL3T8	8
FL3K10	FL3T10	10
FL3K12	FL3T12	12
FL3K15	FL3T15	15
FL3K20	FL3T20	20
FL3K25	FL3T25	25
FL3K30	FL3T30	30
FL3K40	FL3T40	40
FL3K50	FL3T50	50
FL3K65	FL3T65	65
FL3K80	FL3T80	80
FL3K100	FL3T100	100
FL3K140	FL3T140	140
FL3K200	FL3T200	200

Adapter-type removable-button links with ferrule adapter to convert to double-leader links are available in K and T types. Order by description.

EEI-NEMA Type K Universal Silver-Element Fuses

for Cutouts — Rated through 27kV

Non-Removable Button-Head For Standard Open or Enclosed Cutouts

Catalog Numbers	
EEI-NEMA Type K	Amps
FL12K8	8
FL12K10	10
FL12K12	12
FL12K15	15
FL12K25	25
FL12K50	50

Fuseclips for Medium & High Voltage Fuses

Recommended Fuseclips for Medium Voltage Fuses

Catalog Numbers	Fuse Diameter - in (mm)	Clip Dimensions (in)						
		A	B	C	D	E	F	G
A3354710	2 (50.8)	3.749	1.979	2.009	1.189	4.539	1.509	0.399
A3354730	3 (76)	4.139	2.449	3.009	1.189	5.639	1.509	0.399
A3354745	1.77 (45)	3.50	2.50	1.77	1.19	4.50	1.50	0.38

Fuseclips are for single barrel applications only. Are not sold in pairs.

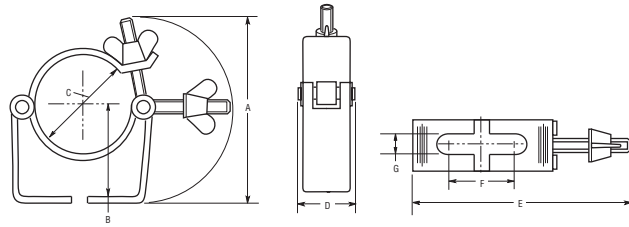

1A0065 3" Diameter Clip

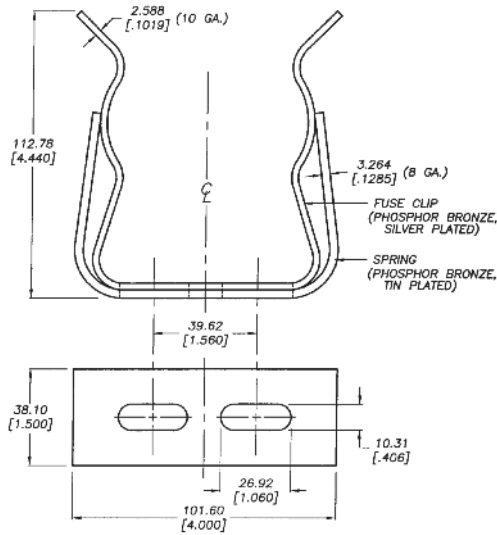

2 CLIP ASSEMBLIES PER PACKAGE.
DIMENSIONS SHOWN ARE FOR REFERENCE ONLY.

270303 DIN Fuseclip

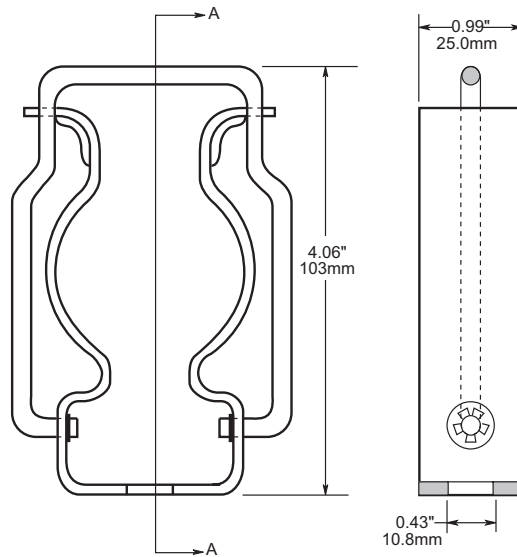

9078A67G04 3" Diameter Clip

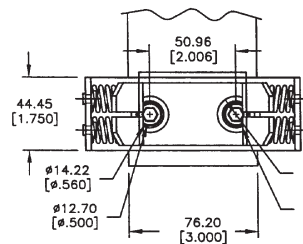
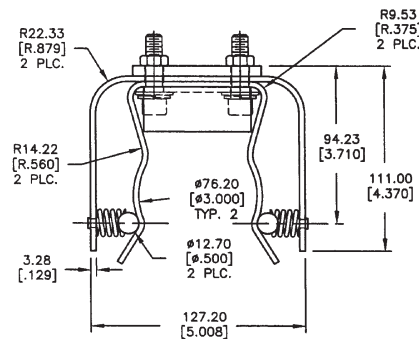

2 Cup assemblies per package.
Dimensions shown are for reference only.

High Speed Fuses

Section Contents

	Page
General Applications	122-123
North American fuses & accessories	124-141
DFJ - High speed Class J fuse	125
Square Body fuses & accessories	142-213
BS 88 fuses & accessories	214-222
Ferrule fuses & accessories.	223-243



Scan this tag to get the latest product information for High Speed Fuses.



General Applications

Rated Voltage

The AC voltage rating of Bussmann fuses is given in volts rms. Fuses tested to IEC are tested at 5% above their rated voltage. British Style BS 88 fuses are tested at 10% above their rated voltage. UL recognition tests are performed at the rated voltage.

Rated Current

Rated current is given in amps rms. Bussmann fuses can continuously carry the rated current.

Melting Characteristic

The melting characteristic shows the virtual melting time in seconds as a function of the prospective current in amps rms. The fuses are specially constructed for short-circuit protection against high level fault currents. Loading and operation of the fuse in the non-continuous/dashed section of the melt curve must be avoided. The curve can also be read as the real melting time as a function of the RMS value of the pre-arc current.

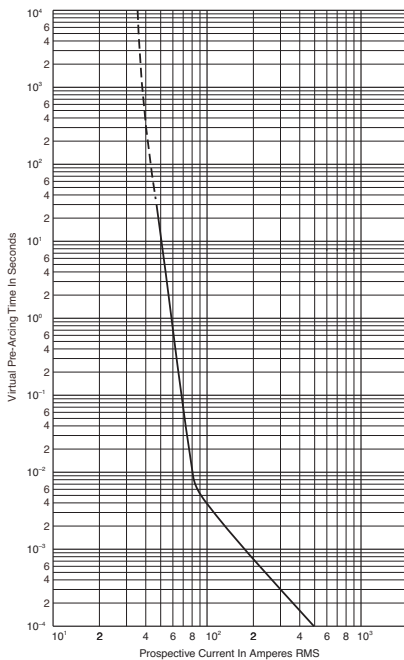

Clearing Integrals

The total clearing I^2t at rated voltage and at power factor of 15% are given in the electrical characteristics. For other voltages, the clearing I^2t is found by multiplying by correction factor, K, given as a function of applied working voltage, E_g , (rms).

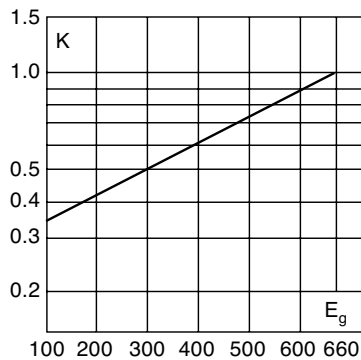

Power Factor

For other power factor values, the total clearing integral can be calculated as a multiple of the clearing integrals, the correction factor K and the correction factor X.

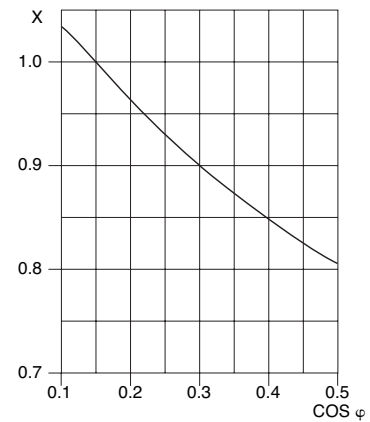

Arc Voltage

This curve gives the peak arc voltage, U_L , which may appear across the fuse during its operation as a function of the applied working voltage, E_g , (rms) at a power factor of 15%.

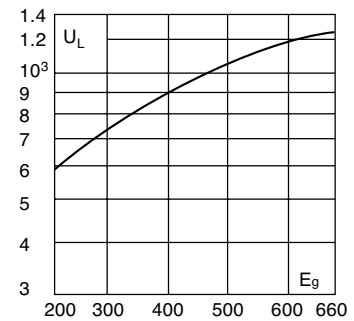

Power Losses

Watts loss at rated current is given in the electrical characteristics. The curve allows the calculation of the power losses at load currents lower than the rated current. The correction factor, K_p , is given as a function of the RMS load current, I_b , in % of the rated current.

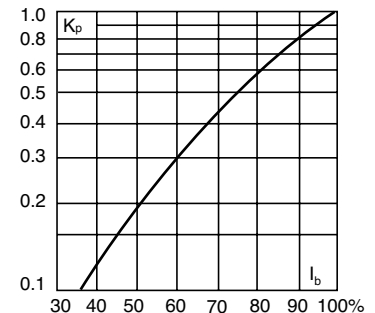

Cut-Off Current

A fuse operation relating to short-circuits only. When a fuse operates in its current-limiting range, it will clear a short-

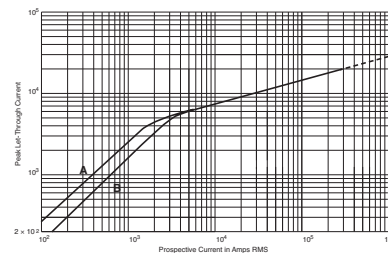

circuit in less than 1/2 cycle. Also, it will limit the instantaneous peak let-through current to a value substantially less than

General Applications

that obtainable in the same circuit if that fuse were replaced with a solid conductor of equal impedance.

- A asymmetrical current
- B symmetrical current

Parallel Connection

When fuses are connected in parallel it is recommended that the applied voltage does not exceed $0.9 U_N$ (the rated voltage of the fuse). This is due to the fact that the energy released within the fuses may be unevenly shared between the parallel connected barrels.

When fuses are connected in parallel, one must take into account that the current sharing is not necessarily equal. And it must be checked, that the maximum load current is not exceeded.

Series Connection

Fuses in series may not equally divide the applied voltage. It is recommended that series connected fuses should only be operated at fault currents that yield melting times less than 10 ms and a recovery voltage per fuse of less than or equal to $0.9 U_N$ (the rated voltage of the fuse).

Mounting Guidance

The recommendations below have to be followed when mounting a Bussmann fuse with end plate threaded holes.

1. Screw in studs: 5 N•m Max, 3 N•m Min
2. Attachment of the fuse to bussbar by means of nut and washer:

Thread Configuration	Torque (N•m)*	
	Max	Min
5/16" - 18, M8	25	20
3/8" - 16, M10	45	40
1/2" - 24	45	40
1/2" - 13, M12	65	50
1/2" - 20	65	50

*1 N•m = 0.7375 lb-ft

Overloads

The design of Bussmann fuses is such that they can be operated under rather severe operating conditions imposed by overloads (any load current in excess of the maximum permissible load current).

In applications, there will be a maximum overload current, I_{max} , which can be imposed on the fuse with a corresponding duration and frequency of occurrence.

Time durations fall into two categories:

1. Overloads longer than one second
2. Overloads less than one second termed "impulse" loads.

The following table gives general application guidelines which, in the expression $I_{max} < (\% \text{ factor}) \times I_t$, I_t is the

melting current corresponding to the time "t" of the overload duration as read from the time-current curve of the fuse. The guidelines in the table below determine the acceptability of the selected fuses for a given I_{max} :

Frequency of Occurrence	Overloads (> 1 sec)	Impulse Loads (< 1 sec)
Less than once per month	$I_{max} < 80\% \times I_t$	$I_{max} < 70\% \times I_t$
Less than twice per week	$I_{max} < 70\% \times I_t$	$I_{max} < 60\% \times I_t$
Several times per day	$I_{max} < 60\% \times I_t$	—

When impulse loads are an intrinsic/normal parameter of the load current either as single pulse or in trains of pulses or when their level is higher than the melting current at 0.01 seconds (per time-current curve), contact Bussmann for application assistance.

In addition to the parameters set forth in the preceding table, the RMS value of the load current as calculated for any period of 10 minutes or more should not exceed the maximum permissible load current.

Furthermore, it is important that a fuse should not be applied in the non-continuous/dashed portion of the associated time-current curve.

Any time-current combination point which falls in the non-continuous/dashed portion of the time-current curve is beyond the capability of the fuse to operate properly.

DC Operation

Depending upon the short-circuit time constant and the magnitude of the prospective short-circuit current, the dc voltage at which a fuse can be applied may be less than its ac rating. Long time constants require a lower dc voltage. Conversely, however, higher available prospective short-circuit currents result in faster fuse openings and thus permit a fuse to be operated at a higher DC voltage.

Consult Bussmann for additional information and application assistance when fuses have to operate under DC conditions.

Load Current Versus Conductor Cross Section

Reduction of permissible load current when the conductor cross section is less than that given in IEC Publication 269-1 & 4 valid for Bussmann high speed fuses.

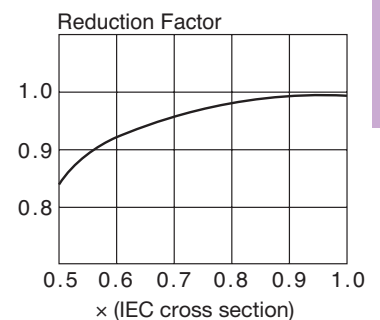

Application Assistance

If you have application problems or need a fuse outside our standard program, please contact the nearest Bussmann representative. Phone numbers are shown on the back cover.

North American Fuses



Introduction

North American Contents

Catalog Number	Volts	Amp Range	Page
DFJ	600	1-600	125
FWA	130	1000-4000	126-127
FWA	150	70-1000	128-129
FWX	250	35-2500	130-131
FWH	500	35-1600	132-133
KAC	600	1-1000	134
KBC	600	35-800	135
FWP	700	5-1200	136-138
FWJ	1000	35-2000	139-140

Accessories

Fuse Bases 141

North American Fuse Ranges

Amps	Volts	AC	DC
1000-4000	130	X	X
70-1000	150	X	X
35-2500	250	X	X
35-1600	500	X	X
1-1000	600	X	—
5-1200	700	X	X
40-600	800	—	X
35-2000	1000	X	—

General Information

Bussmann offers a complete range of North American blade and flush-end style fuses and accessories. Their design and construction were optimized to provide:

- Low energy let-through (I²t)
- Low watts loss
- Superior cycling capability
- Low arc voltage
- Excellent DC performance

North American style fuses provide an excellent solution for medium power applications. While there are currently no published standards for these fuses, the industry has standardized on mounting centers that accept Bussmann fuses.

Voltage Rating

All Bussmann North American style fuses are tested at their rated voltage. Bussmann should be consulted for applications exceeding those values.

Accessories

External and internal open fuse indication is available for selected portions of the North American line. Fuse blocks are available for most applications.

Drive Fuse High Speed Fuses

DFJ Class J



Specifications

Description: High speed, current-limiting fuse. The Bussmann Drive Fuse will provide maximum protection for AC and DC drives and controllers and meet NEC® branch circuit protection requirements. The Drive Fuse has the lowest I²t of any branch circuit fuse to protect power semiconductor devices that utilize diodes, GTOs, SCRs and SSRs.

Dimensions: See page 21 for Class J dimensions.

Construction: Melamine tube with silver fuse element.

Ratings:

Volts — 600Vac (or less), 450Vdc (or less)

Amps — 1-600A

IR — 200kA RMS Sym., 100kA DC

Agency Information: CE, Std. 248-8, Class J, UL Listed, Guide JDDZ, File E4273, CSA Certified, Class 1422-02, File 53787.

Features and Benefits

- Easily coordinated with existing and new variable speed drives and electric controllers.
- Standard Class J dimensions allowing the use of readily available fuse blocks, holders, and switches.
- Allows the lowest let-thru energy of any branch circuit overcurrent protective device.

Typical Applications

- Protection of AC and DC drives
- Equipment using power semiconductor devices

Catalog Numbers (Amps)

DFJ-1	DFJ-15	DFJ-70	DFJ-225
DFJ-2	DFJ-20	DFJ-80	DFJ-250
DFJ-3	DFJ-25	DFJ-90	DFJ-300
DFJ-4	DFJ-30	DFJ-100	DFJ-350
DFJ-5	DFJ-35	DFJ-110	DFJ-400
DFJ-6	DFJ-40	DFJ-125	DFJ-450
DFJ-8	DFJ-45	DFJ-150	DFJ-500
DFJ-10	DFJ-50	DFJ-175	DFJ-600
DFJ-12	DFJ-60	DFJ-200	

Data Sheet: 1048

Time-Current Characteristic Curves—Average Melt

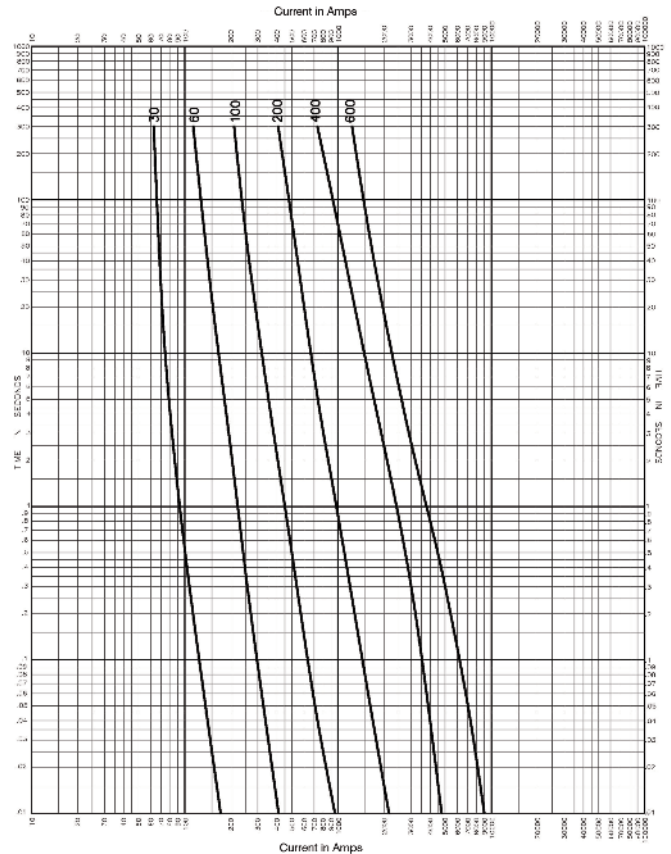

Current Limitation Curves

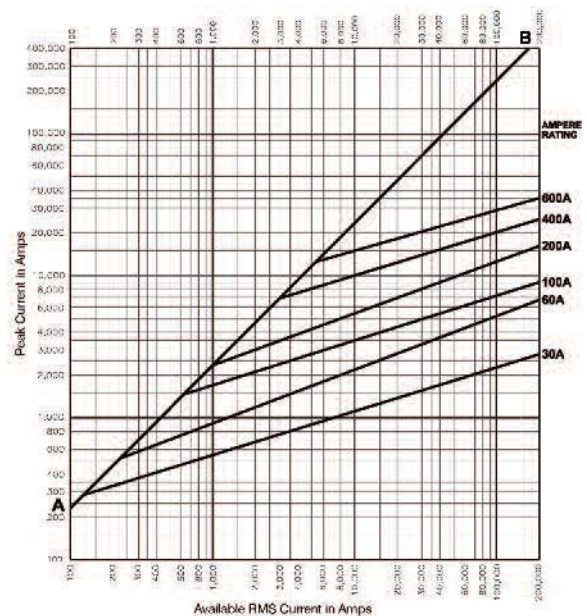

North American — FWA 130V: 1000-4000A

FWA

Specifications

Description: North American style flush-end high speed fuses.

Dimensions: See Dimensions illustrations.

Ratings:

- Volts: — 130Vac
- Amps: — 1000-4000A
- IR: — 200kA RMS Sym.
- 50kA @130Vdc

Agency Information: CE, UL Recognized JFHR2.E91958 on 1000-2000A fuses

Electrical Characteristics

Total Clearing I²t

The total clearing I²t at rated voltage and at power factor of 15% are given in the electrical characteristics. For other voltages, the clearing I²t is found by multiplying by correction factor, K, given as a function of applied working voltage, E_g, (rms).

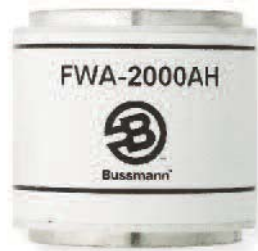
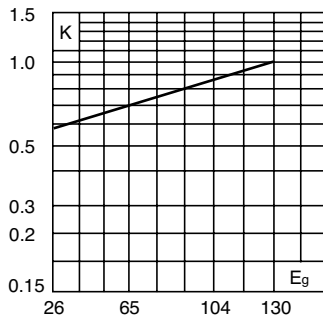

Arc Voltage

This curve gives the peak arc voltage, U_L, which may appear across the fuse during its operation as a function of the applied working voltage, E_g, (rms) at a power factor of 15%.

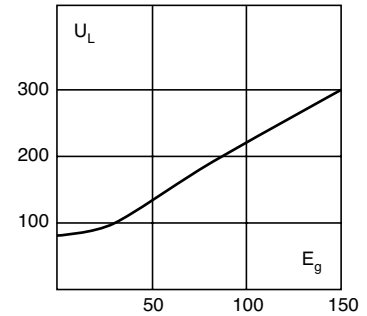

Power Losses

Watts loss at rated current is given in the electrical characteristics. The curve allows the calculation of the power losses at load currents lower than the rated current. The correction factor, K_p, is given as a function of the RMS load current, I_b, in % of the rated current.

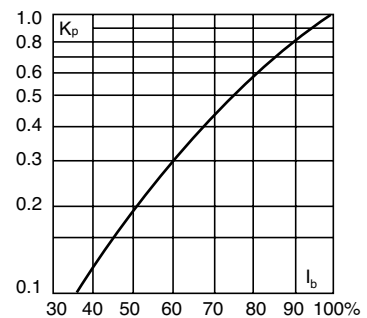

Catalog Numbers

Catalog Numbers	Electrical Characteristics			
	Rated Current RMS-Amps	I ² t (A ² Sec)		Watts Loss
		Pre-arc	Clearing at 130V	
FWA-1000AH	1000	170000	460000	60
FWA-1200AH	1200	270000	730000	70
FWA-1500AH	1500	520000	1400000	78
FWA-2000AH	2000	860000	2400000	108
FWA-2500AH	2500	1500000	4100000	130
FWA-3000AH	3000	2100000	5700000	150
FWA-4000AH	4000	3400000	9200000	257

• Watts loss provided at rated current.
• See accessories on page 141.

Features and Benefits

- Excellent DC performance
- Low arc voltage and low energy let-through (I²t)
- Low watts loss
- Superior cycling capability

Typical Applications

- DC Common bus
- DC Drives
- Power converters/rectifiers
- Reduced voltage starters

Dimensions - in

Catalog Number	Fig.	B	C	D	Thread Depth
FWA-1000AH-2000AH	1	2.0	1.0	—	Tapped 3/8"-24 x 1/2"
FWA-2500AH-3000AH	1	3.0	1.5	—	Tapped 1/2"-20 x 1/2"
FWA-4000AH	2	3.5	1.5	1.5	Tapped 1/2"-20 x 1/2"

1mm = 0.0394" / 1" = 25.4mm

Fig. 1: 1000-3000A

Fig. 2: 4000A

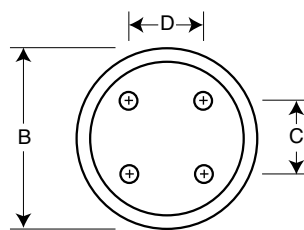
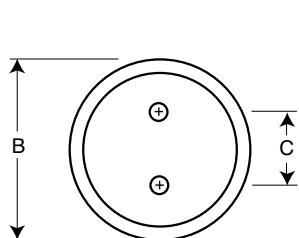
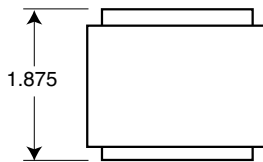
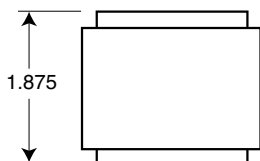

North American — FWA 130V: 1000-4000A

FWA 1000-4000A: 130V

Time-Current Curve

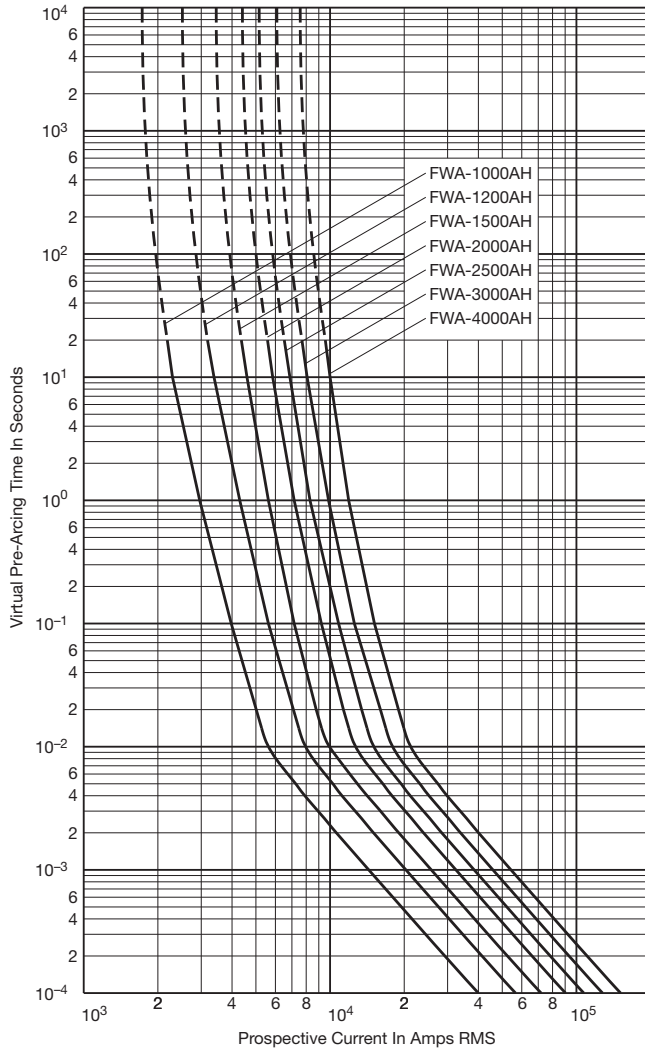

Peak Let-Through Curve

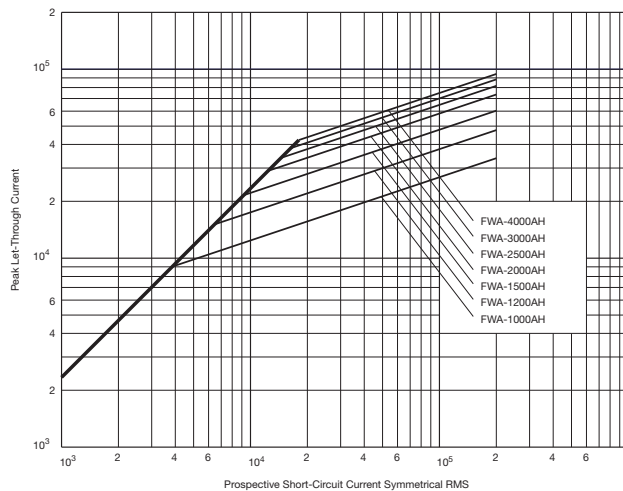

Data Sheet: 35785301

North American — FWA 150V: 70-1000A

FWA

Specifications

Description: North American style stud-mount fuses.

Dimensions: See Dimensions illustrations.

Ratings:

- Volts: — 150Vac/dc*
- Amps: — 70-1000A
- IR: — 100kA Sym. (70-400A)
- 200kA Sym. (450-1000A)
- 20kA @ 150Vdc (70-800A)
- 100kA @ 80Vdc (70-1000A)

*1000A rated @ 80Vdc.

Agency Information: CE, UL Recognized JFHR2.E91958

Electrical Characteristics

Total Clearing I²t

The total clearing I²t at rated voltage and at power factor of 15% are given in the electrical characteristics. For other voltages, the clearing I²t is found by multiplying by correction factor, K, given as a function of applied working voltage, E_g, (rms).

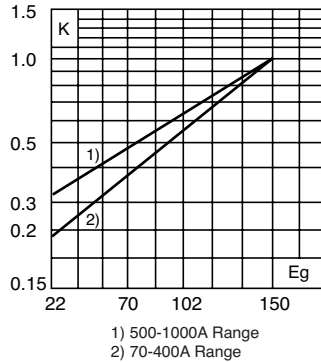

Arc Voltage

This curve gives the peak arc voltage, U_L, which may appear across the fuse during its operation as a function of the applied working voltage, E_g, (rms) at a power factor of 15%.

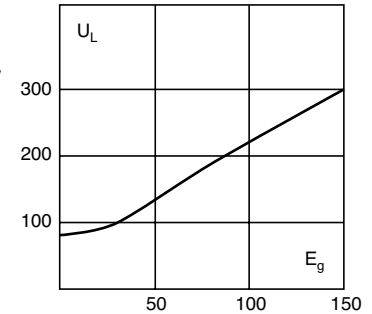

Power Losses

Watts loss at rated current is given in the electrical characteristics. The curve allows the calculation of the power losses at load currents lower than the rated current. The correction factor, K_p, is given as a function of the RMS load current, I_b, in % of the rated current.

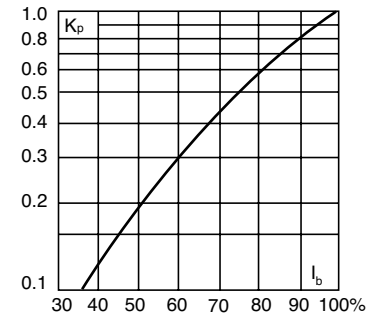

Catalog Numbers

Catalog Number	Rated Current RMS-Amps	Electrical Characteristics		
		I ² t (A ² Sec)		Watts Loss
		Pre-arc	Clearing at 150V	
FWA-70B	70	470	4000	6.9
FWA-80B	80	670	6000	7.7
FWA-100B	100	1200	12000	9.0
FWA-125B	125	1870	18000	11.2
FWA-150B	150	2700	26000	13.5
FWA-200B	200	4780	45000	17.6
FWA-250B	250	7470	70000	22.5
FWA-300B	300	10760	100000	27.0
FWA-350B	350	15700	140000	30.6
FWA-400B	400	20300	180000	35.2
FWA-500A	500	39000	120000	35.0
FWA-600A	600	46000	140000	47.0
FWA-700A	700	75000	220000	49.0
FWA-800A	800	92000	280000	58.0
FWA-1000A	1000	170000	510000	60.0

• Watts loss provided at rated current.
• See accessories on page 141.

Features and Benefits

- Excellent DC performance
- Low arc voltage and low energy let-through (I²t)
- Low watts loss
- Superior cycling capability

Typical Applications

- DC Common bus
- DC Drives
- Power converters/rectifiers
- Reduced voltage starters

Dimensions - in

Fig. 1: 70-400A

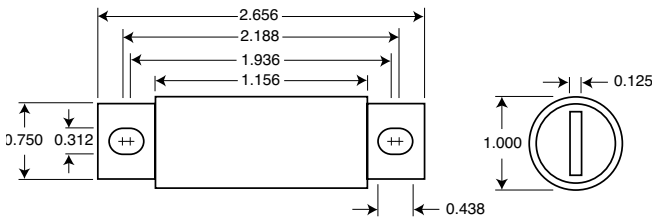
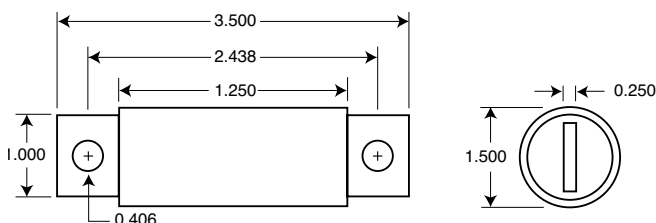

Fig. 2: 500-1000A



1mm = 0.0394" / 1" = 25.4mm

North American — FWA 150V: 70-1000A

FWA 70-1000A: 150V

Time-Current Curve

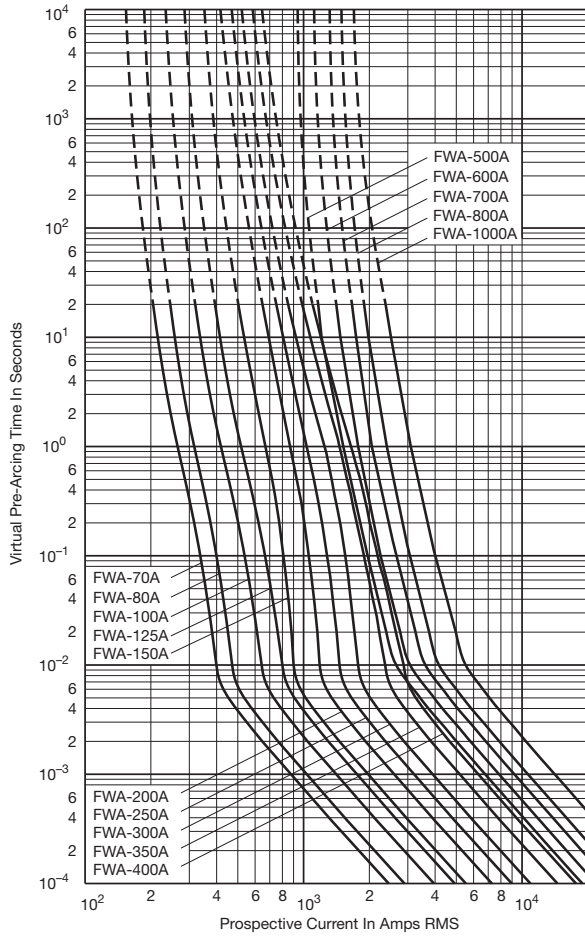

Peak Let-Through Curve

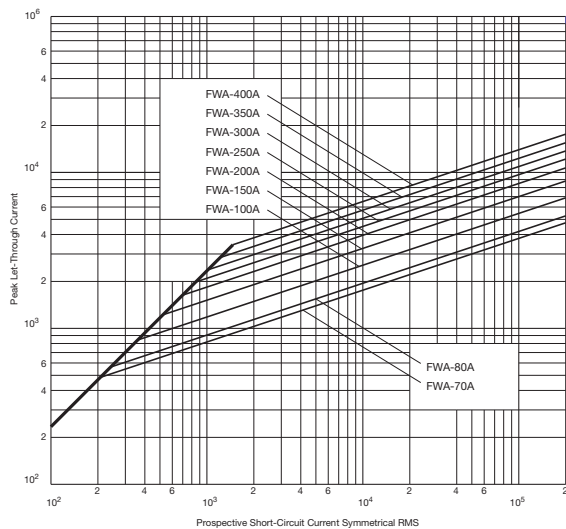

Data Sheet: 35785310

North American — FWX 250V: 35-2500A

FWX

Specifications

Description: North American style stud-mount and flush-end fuses.

Dimensions: See Dimensions illustrations.

Ratings:

- Volts: — 250Vac/dc
- Amps: — 35-2500A
- IR: — 200kA RMS Sym.
50kA@250Vdc (35-800A)

Agency Information: CE, UL Recognized JFHR2.E56412 & CSA Component Acceptance file Class 1422-30, (53787) on 35-800A fuses (50kA IR @250Vdc).

Electrical Characteristics

Total Clearing I²t

The total clearing I²t at rated voltage and at power factor of 15% are given in the electrical characteristics. For other voltages, the clearing I²t is found by multiplying by correction factor, K, given as a function of applied working voltage, E_g, (rms).

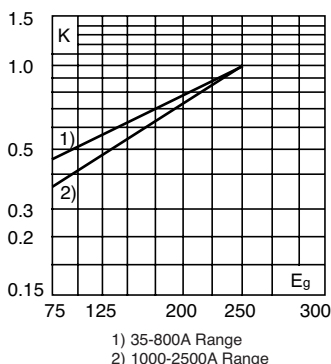

Dimensions - in

Amp Range	Fig.	A	B	C	D	E	F	G	H	J	Tapped Thread Depth
35-60	1	3.19	0.81	1.59	2.59	2.25	0.34	0.63	0.13	0.52	—
70-200	1	3.13	1.22	1.59	2.44	2.19	0.34	1.00	0.19	0.47	—
225-600	1	3.84	1.50	1.59	2.94	2.25	0.41	1.00	0.25	0.75	—
700-800	1	3.84	2.00	1.59	3.03	2.28	0.41	1.50	0.25	0.78	—
1000-1200	2	2.59	3.00	1.50	—	—	—	—	—	—	3/8"-24 x 1/2"
1500-2500	3	2.59	3.50	1.50	—	—	—	—	—	—	3/8"-24 x 1/2"

1mm = 0.0394" / 1" = 25.4mm

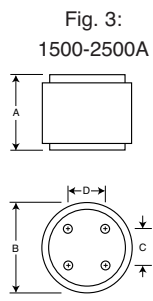
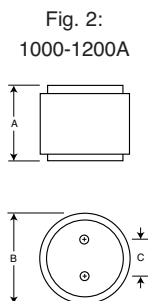
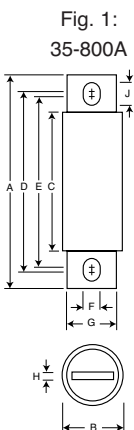

Arc Voltage

This curve gives the peak arc voltage, U_L, which may appear across the fuse during its operation as a function of the applied working voltage, E_g, (rms) at a power factor of 15%.

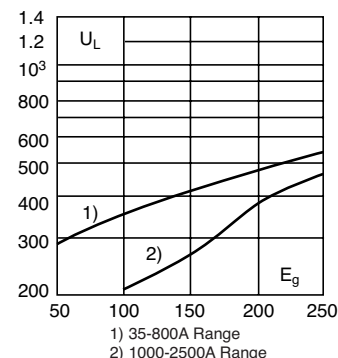

Power Losses

Watts loss at rated current is given in the electrical characteristics. The curve allows the calculation of the power losses at load currents lower than the rated current. The correction factor, K_p, is given as a function of the RMS load current, I_b, in % of the rated current.

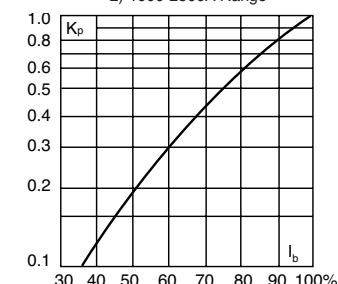

Catalog Numbers

Catalog Number	Rated Current RMS-Amps	Electrical Characteristics		
		I ² t (A ² Sec)		Watts Loss
		Pre-arc	Clearing at 250V	
FWX-35A	35	50	230	4.2
FWX-40A	40	60	310	5.2
FWX-45A	45	80	390	5.7
FWX-50A	50	100	520	6.0
FWX-60A	60	140	740	8.1
FWX-70A	70	330	1400	7.2
FWX-80A	80	430	1850	8.1
FWX-90A	90	570	2450	9.0
FWX-100A	100	740	3150	10.0
FWX-125A	125	1130	4850	12.5
FWX-150A	150	1620	6950	15.7
FWX-175A	175	2170	9300	18.5
FWX-200A	200	2790	12000	22
FWX-225A	225	3210	14700	24
FWX-250A	250	3960	18100	27
FWX-275A	275	4720	21600	31
FWX-300A	300	6000	27300	32
FWX-350A	350	10600	48600	39
FWX-400A	400	14500	66100	44
FWX-450A	450	22100	101000	49
FWX-500A	500	28000	128000	54
FWX-600A	600	41100	188000	62
FWX-700A	700	48800	190000	72
FWX-800A	800	59000	230000	84
FWX-1000AH	1000	44000	360000	100
FWX-1200AH	1200	92000	750000	103
FWX-1500AH	1500	120000	880000	140
FWX-1600AH	1600	160000	1200000	140
FWX-2000AH	2000	320000	2300000	151
FWX-2500AH	2500	670000	4700000	163

• Watts loss provided at rated current. • See accessories on page 141.

Features and Benefits

- Excellent DC performance
- Low arc voltage and low energy let-through (I²t)
- Superior cycling capability

Typical Applications

- DC Common bus
- DC Drives
- Power converters/rectifiers
- Reduced voltage starters

Data Sheet: 720005

North American — FWX 250V: 35-2500A

FWX 35-800A: 250V

Time-Current Curve

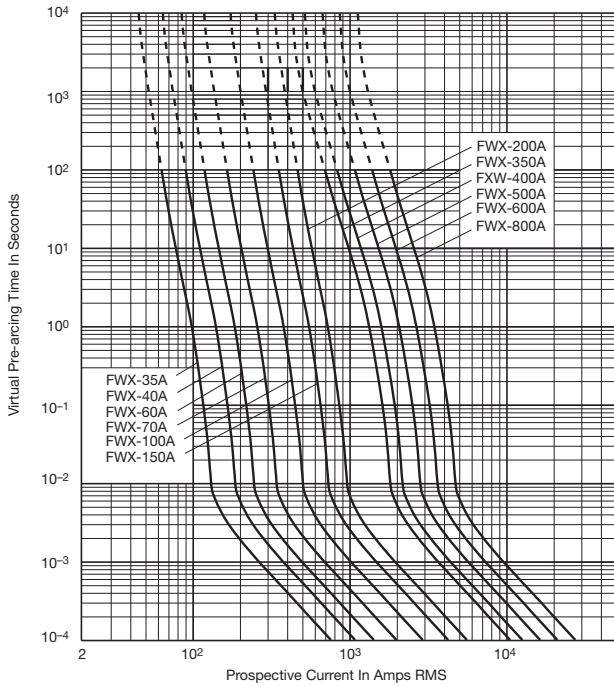

Peak Let-Through Curve

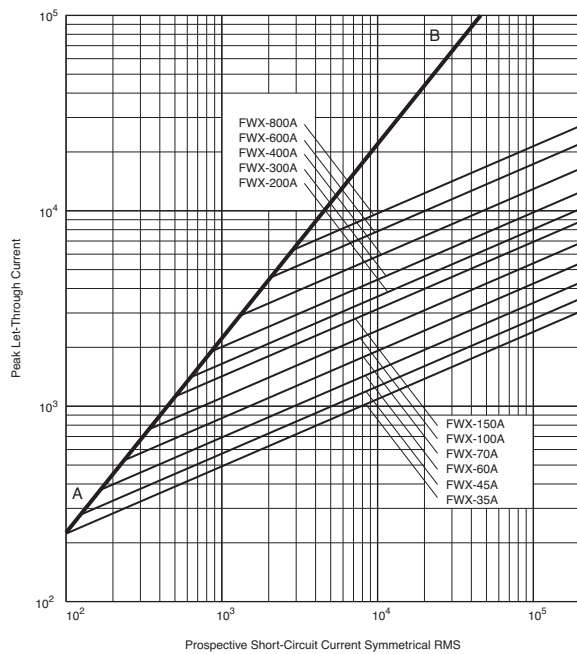

FWX 1000-2500A(H): 250V

Time-Current Curve

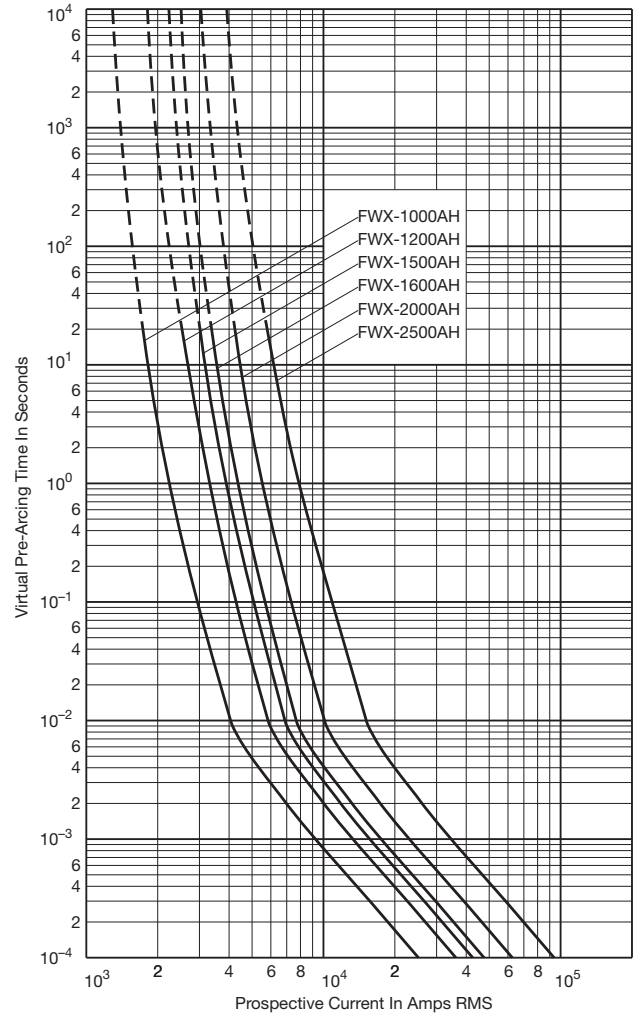

Peak Let-Through Curve

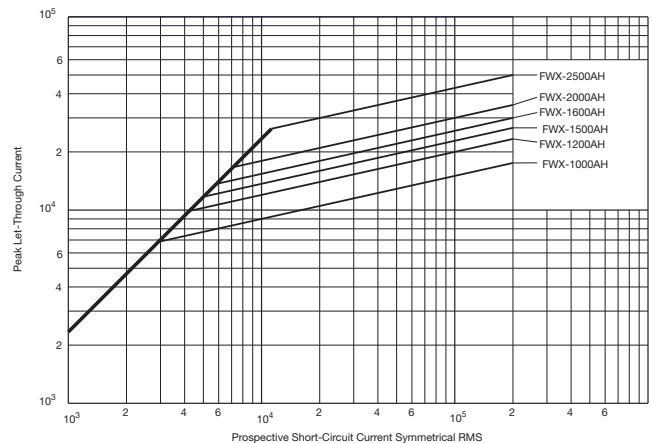

North American — FWH 500V: 35-1600A

FWH

Specifications

Description: North American style stud-mount fuses.

Dimensions: See Dimensions illustration.

Ratings:

Volts: — 500Vac/dc (35-800A only)

Amps: — 35-1600A

IR: — 200kA Sym.

— 50kA @ 500Vdc (35-800A)

Agency Information: CE, UL Recognition JFHR2.E91958

FWH_B (35-200A, 1000-1200A), JFHR2.E56412

FWH_A (225-600A), CSA Component Acceptance Class 1422-30, File 53787 (35-1600A).



Electrical Characteristics

Total Clearing I²t

The total clearing I²t at rated voltage and at power factor of 15% are given in the electrical characteristics. For other voltages, the clearing I²t is found by multiplying by correction factor, K, given as a function of applied working voltage, E_g, (rms).

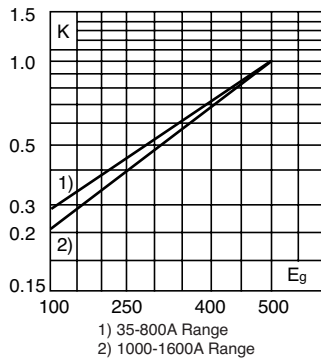

Dimensions - in

Amp Range	Fig.	A	B	C	D	E	F	G	H	J
35-60	1	3.188	0.813	1.593	2.541	2.193	0.344	0.719	0.125	0.518
70-100	1	3.625	0.947	1.736	2.853	2.807	0.352	0.750	0.125	0.375
125-200	1	3.625	1.156	1.836	2.892	2.768	0.344	1.000	0.188	0.406
225-400	1	4.340	1.500	2.090	3.440	2.750	0.410	1.000	0.250	0.750
450-600	1	4.340	2.000	2.090	3.530	2.780	0.410	1.500	0.250	0.780
700-800	1	6.340	2.500	2.090	4.970	3.440	0.530	2.000	0.380	1.300
1000-1200	1	6.969	3.000	3.219	5.465	4.475	0.625	2.375	0.438	1.120
1400-1600	2	See Drawing								

1mm = 0.0394" / 1" = 25.4mm

Fig. 1: 35-1200A

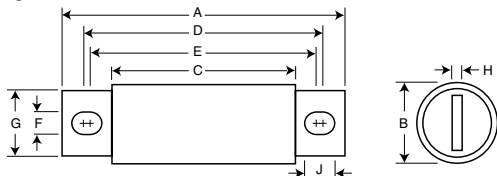
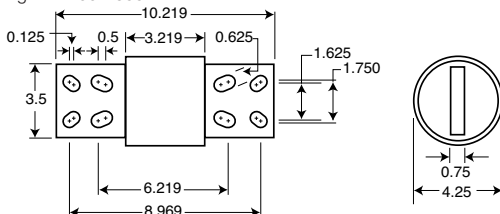
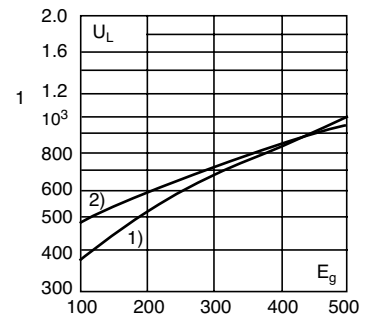

Fig. 2: 1400-1600A



Arc Voltage

This curve gives the peak arc voltage, U_L, which may appear across the fuse during its operation as a function of the applied working voltage, E_g, (rms) at a power factor of 15%.



Power Losses

Watts loss at rated current is given in the electrical characteristics. The curve allows the calculation of the power losses at load currents lower than the rated current. The correction factor, K_p, is given as a function of the RMS load current, I_b, in % of the rated current.

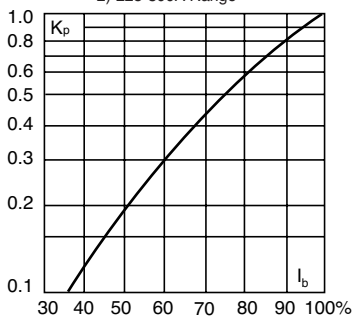

Catalog Numbers

Catalog Numbers	Electrical Characteristics			
	Rated Current RMS-Amps	I ² t (A ² Sec)		Watts Loss
		Pre-arc	Clearing at 500V	
FWH-35B	35	34	150	8
FWH-40B	40	76	320	7.5
FWH-45B	45	105	450	7.5
FWH-50B	50	135	670	7.5
FWH-60B	60	210	900	9.9
FWH-70B	70	210	900	10.6
FWH-80B	80	305	1400	12.7
FWH-90B	90	360	1600	15
FWH-100B	100	475	2000	17
FWH-125B	125	800	3500	25
FWH-150B	150	1100	4600	30
FWH-175B	175	1450	6200	35
FWH-200B	200	1900	8500	40
FWH-225A	225	4600	23300	39
FWH-250A	250	6300	32200	41
FWH-275A	275	7900	40300	46
FWH-300A	300	9800	49800	51
FWH-325A	325	13700	63800	53
FWH-350A	350	14500	72900	58
FWH-400A	400	19200	96700	65
FWH-450A	450	24700	127000	74
FWH-500A	500	29200	149000	84
FWH-600A	600	41300	206000	108
FWH-700A	700	55000	298000	120
FWH-800A	800	76200	409000	129
FWH-1000A	1000	92000	450000	145
FWH-1200A	1200	122000	600000	180
FWH-1400A	1400	200000	1000000	210
FWH-1600A	1600	290000	1400000	230

* Watts loss provided at rated current. * See accessories on page 141.

Features and Benefits

- Excellent DC performance
- Low arc voltage and low energy let-through (I²t)
- Superior cycling capability

Typical Applications

- DC Common bus
- DC Drives
- Power converters/rectifiers
- Reduced voltage starters

Data Sheet: 720007

North American — FWH 500V: 35-1600A

FWH 35-200A(B) & 900-1600A(A): 500V

Time-Current Curve

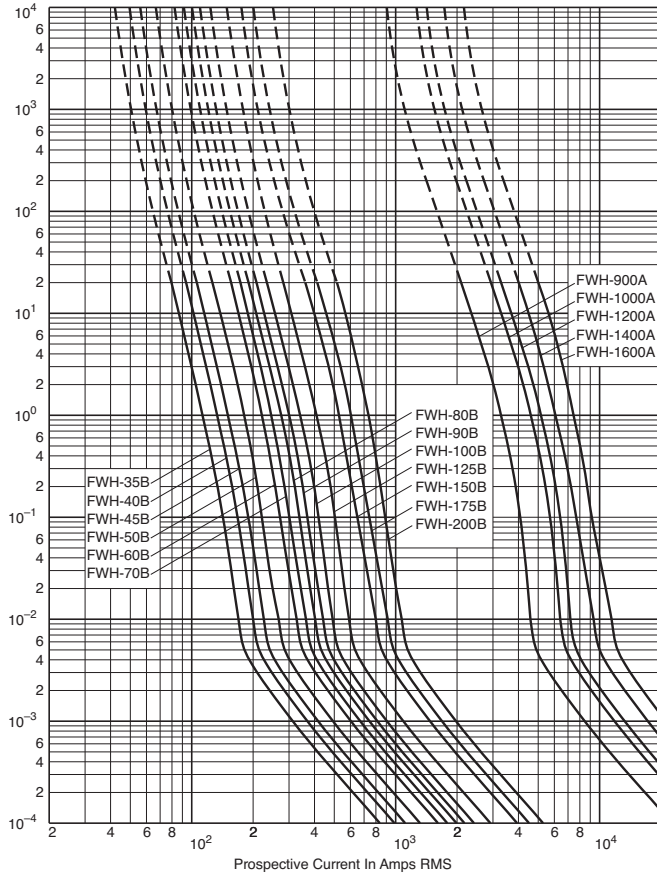

FWH 250-800A: 500V

Time-Current Curve

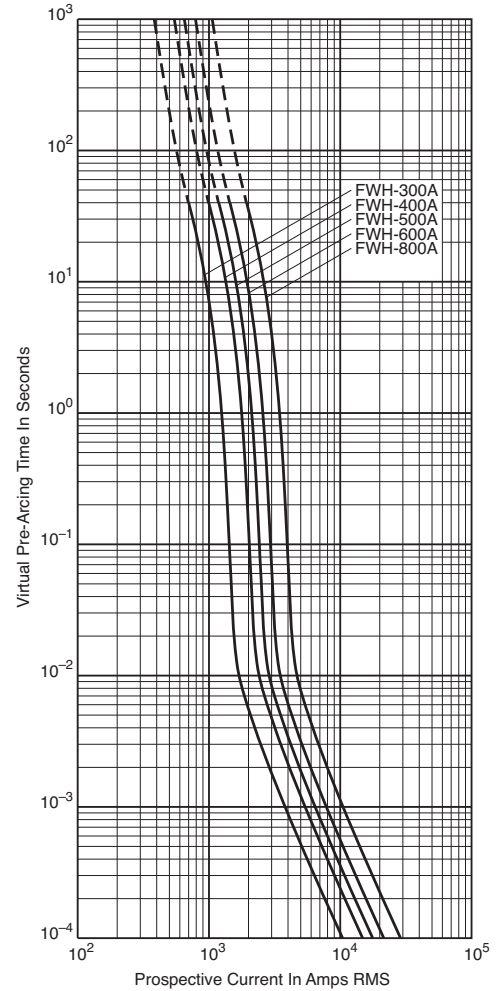

Peak Let-Through Curve

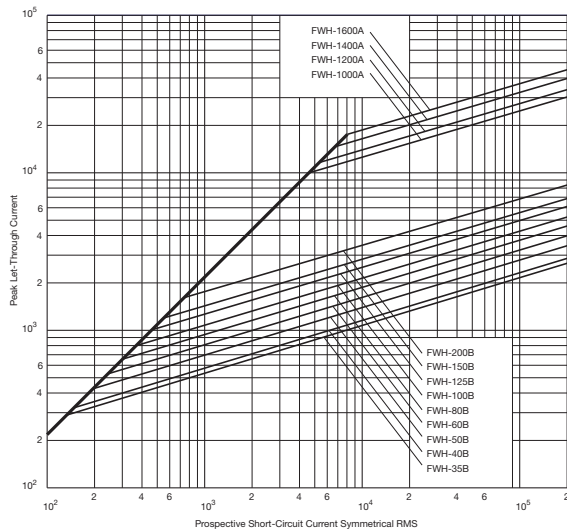

Peak Let-Through Curve

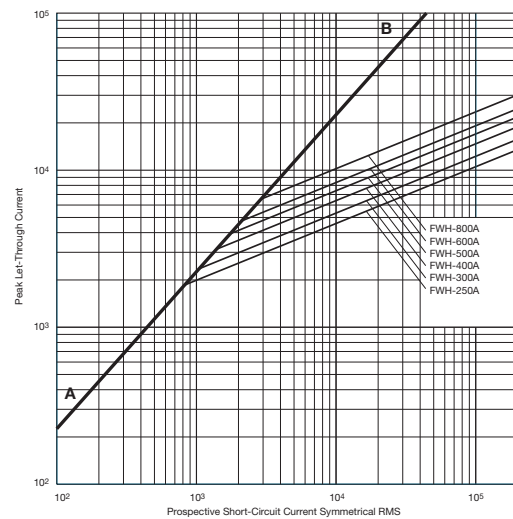

North American — KAC 600V: 1-1000A

KAC

Specifications

Description: North American style stud-mount fuses. These 600V fuses are supplied as replacements only. For new installations, Bussmann recommends the 700V FWP Series fuse.

Dimensions: See Dimensions illustrations.

Ratings:

Volts: — 600Vac

Amps: — 1-1000A

IR: — 200kA RMS Sym.

Agency Information: CE, UL Recognition JFHR2.E56413 on 1-600A only.



Catalog Numbers (Amps)

KAC-1	KAC-25	KAC-175
KAC-2	KAC-30	KAC-200
KAC-3	KAC-35	KAC-225
KAC-4	KAC-40	KAC-250
KAC-5	KAC-45	KAC-300
KAC-6	KAC-50	KAC-350
KAC-7	KAC-60	KAC-400
KAC-8	KAC-70	KAC-450
KAC-9	KAC-80	KAC-500
KAC-10	KAC-90	KAC-600
KAC-12	KAC-100	KAC-700
KAC-15	KAC-110	KAC-800
KAC-17.5	KAC-125	KAC-1000
KAC-20	KAC-150	

• See accessories on page 141.

Features and Benefits

- Low arc voltage and low energy let-through (I²t)
- Low watts loss
- Superior cycling capability

Typical Applications

- Power converters/rectifiers
- Reduced voltage starters

Dimensions - in

Amp Range	Fig.	A	B1	B2	B3	C	D	E	F	G	H
1-30A	1	2.875	2.500	—	—	1.875	0.406	—	0.563	0.063	0.257
35-60A	2	4.375	—	3.750	3.500	2.750	0.625	0.343	0.813	0.094	0.468
70-100A	2	5.000	—	4.063	3.656	2.750	0.750	0.406	1.000	0.125	0.609
110-200A	2	5.140	—	4.390	3.766	2.906	1.000	0.406	1.500	0.188	0.718
225-400A	2	6.182	—	4.815	4.565	3.000	1.625	0.562	2.000	0.250	0.687
450-800A	1	6.250	4.750	—	—	3.063	2.000	—	2.500	0.250	0.563
1000A	1	7.250	4.750	—	—	3.063	2.750	—	3.500	0.375	0.563

1mm = 0.0394" / 1" = 25.4mm

Fig. 1: 1-30 & 450-1000A

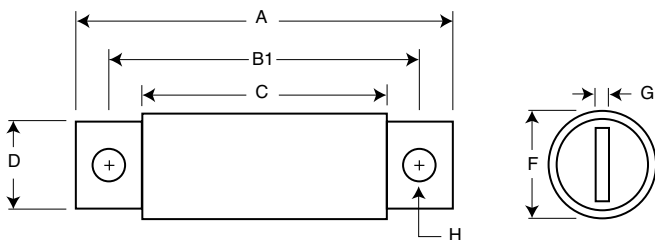
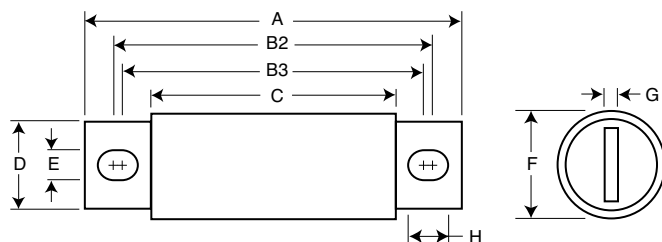

Fig. 2: 35-400A



North American — KBC 600V: 35-800A

KBC

Specifications

Description: North American style stud-mount and flush-end fuses. These 600V fuses are supplied as replacements only. For new installations, Bussmann recommends the 700V FWP Series fuse.

Dimensions: See Dimensions illustrations.

Ratings:

Volts: — 600Vac

Amps: — 35-800A

IR: — 200kA RMS Sym.

Agency Information: CE, UL Recognition JFHR2.E56412 on 35-600A only.



Catalog Numbers (Amps)

KBC-35	KBC-100	KBC-300
KBC-40	KBC-110	KBC-350
KBC-45	KBC-125	KBC-400
KBC-50	KBC-150	KBC-450
KBC-60	KBC-175	KBC-500
KBC-70	KBC-200	KBC-600
KBC-80	KBC-225	KBC-800
KBC-90	KBC-250	

• See accessories on page 141.

Features and Benefits

- Low arc voltage and low energy let-through (I^2t)
- Low watts loss
- Superior cycling capability

Typical Applications

- Power converters/rectifiers
- Reduced voltage starters

Dimensions - in

Amp Range	Fig.	A	B	C	D	E	F	G	H	I	
35-60A	1	4.375	3.750	3.500	2.750	0.343	0.625	0.813	0.094	0.468	
70-100A	2	See Drawing									
110-200A	1	4.406	3.719	3.594	2.906	0.312	0.875	1.219	0.187	0.375	
225-400A	1	5.125	4.188	3.563	2.906	0.406	1.000	1.500	0.250	0.719	
450-600A	1	5.125	4.389	3.687	2.875	0.406	1.500	2.000	0.250	0.757	
800A	3	See Drawing									

1mm = 0.0394" / 1" = 25.4mm

Fig. 1: 35-60 and 110-600A

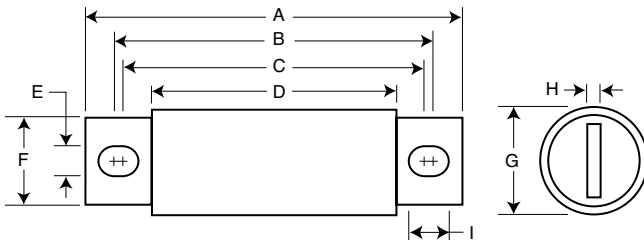

Fig. 2: 70-100A

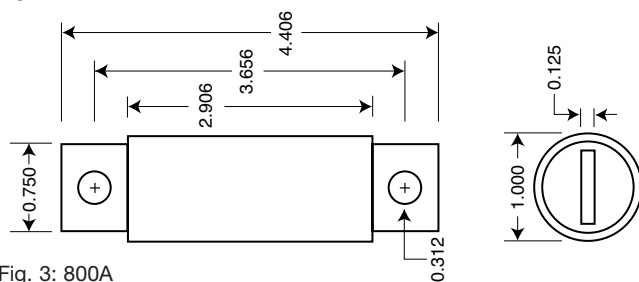
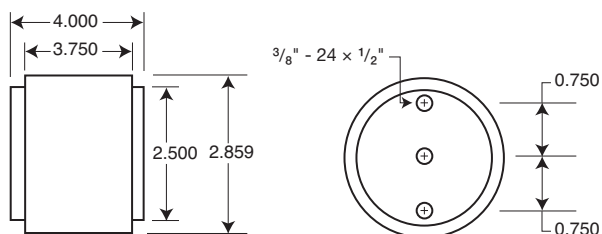

Fig. 3: 800A



Data Sheet: 720010

North American — FWP 700V: 5-1200A

FWP

Specifications

Description: North American style stud-mount fuses.

Dimensions: See Dimensions illustrations.

Ratings:

Volts: — 700Vac/dc

Amps: — 5-1200A

IR: — 200kA RMS Sym.

— 50kA @700Vdc

Agency Information: CE, UL Recognition JFHR2.E91958 FWP_B (5-100A, 700-1200A), JFHR2.E56412 FWP_A (125-600A) & CSA Component Acceptance file Class 1422-30, (53787) on 5-800A

Electrical Characteristics

Total Clearing I²t

The total clearing I²t at rated voltage and at power factor of 15% are given in the electrical characteristics. For other voltages, the clearing I²t is found by multiplying by correction factor, K, given as a function of applied working voltage, E_g, (rms).

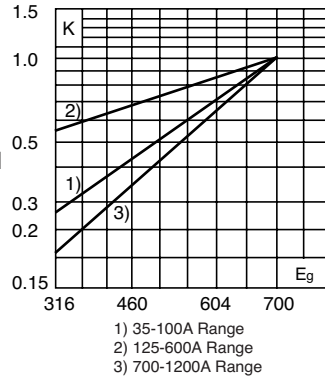

Dimensions - in

Range	Fig.	A	B	C	D	E	F	G	H	I
5-30	1	2.870	0.563	1.855	2.477	2.477	0.250	0.405	0.063	0.250
35-60	1	4.375	0.813	2.750	3.708	3.312	0.344	0.725	0.125	0.542
70-100	1	4.406	0.947	2.594	3.625	3.563	0.344	0.750	0.125	0.375
125-200	1	5.090	1.500	2.840	4.190	3.500	0.410	1.000	0.250	0.750
225-400	1	5.090	2.000	2.840	4.280	3.530	0.410	1.500	0.250	0.780
450-600	1	7.090	2.500	2.840	5.720	4.190	0.530	2.000	0.380	1.300
700-800	1	6.630	2.000	2.844	5.562	5.062	0.625	1.500	0.250	0.875
900-1000	2	See Drawing								
1200	3	See Drawing								

1mm = 0.0394" / 1" = 25.4mm

Fig. 1: 5-800A

Fig. 2: 900-1000A

Fig. 3: 1200A

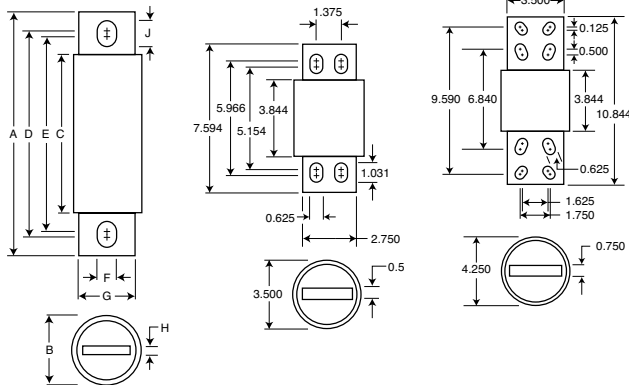

Arc Voltage

This curve gives the peak arc voltage, U_L, which may appear across the fuse during its operation as a function of the applied working voltage, E_g, (rms) at a power factor of 15%.

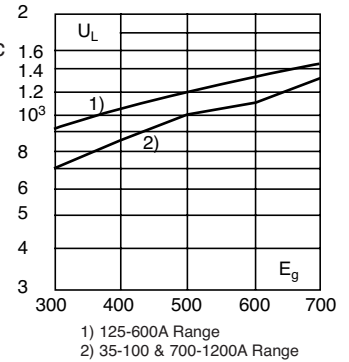

Power Losses

Watts loss at rated current is given in the electrical characteristics. The curve allows the calculation of the power losses at load currents lower than the rated current. The correction factor, K_p, is given as a function of the RMS load current, I_b, in % of the rated current.

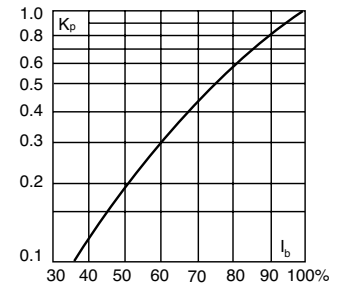

Catalog Numbers

Catalog Numbers	Rated Current RMS-Amps	Electrical Characteristics		
		I ² t (A ² Sec)		Watts Loss
		Pre-arc	Clearing at 700V	
FWP-5B	5	1.6	10	1.5
FWP-10B	10	3.6	20	4
FWP-15B	15	10	75	5.5
FWP-20B	20	26	180	6
FWP-25B	25	44	340	7
FWP-30B	30	58	450	9
FWP-35B	35	34	160	12
FWP-40B	40	76	320	12
FWP-50B	50	135	600	12
FWP-60B	60	210	950	15.5
FWP-70B	70	305	2000	18
FWP-80B	80	360	2400	21
FWP-90B	90	415	2700	25
FWP-100B	100	540	3500	27
FWP-125A	125	1800	7300	28
FWP-150A	150	2900	11700	32
FWP-175A	175	4200	16700	35
FWP-200A	200	5500	22000	43
FWP-225A	225	7700	31300	45
FWP-250A	250	10500	42500	48
FWP-300A	300	17600	71200	58
FWP-350A	350	23700	95600	65
FWP-400A	400	31000	125000	78
FWP-450A	450	36400	137000	94
FWP-500A	500	45200	170000	107
FWP-600A	600	66700	250000	122
FWP-700A	700	54000	300000	125
FWP-800A	800	78000	450000	140
FWP-900A	900	91500	530000	150
FWP-1000A	1000	120000	600000	170
FWP-1200A	1200	195000	1100000	190

* Watts loss provided at rated current. * See accessories on page 141.

Features and Benefits

- Excellent DC performance
- Low arc voltage and low energy let-through (I²t)
- Superior cycling capability

Typical Applications

- DC Common bus
- DC Drives
- Power converters/rectifiers
- Reduced voltage starters

Data Sheet: 720012

North American — FWP 700V: 5-1200A

FWP 5-30A(B): 700V

Time-Current Curve

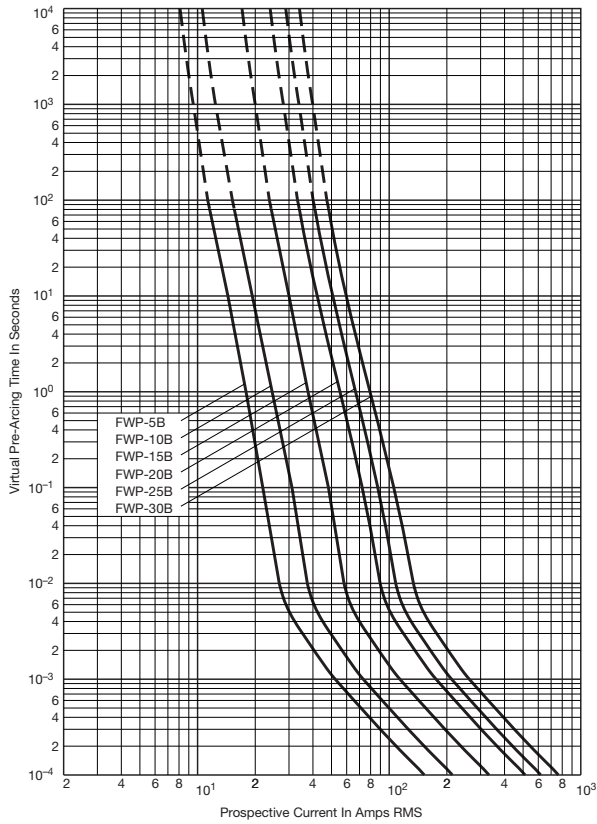

FWP 35-100A(B) & 700-1200A(A): 700V

Time-Current Curve

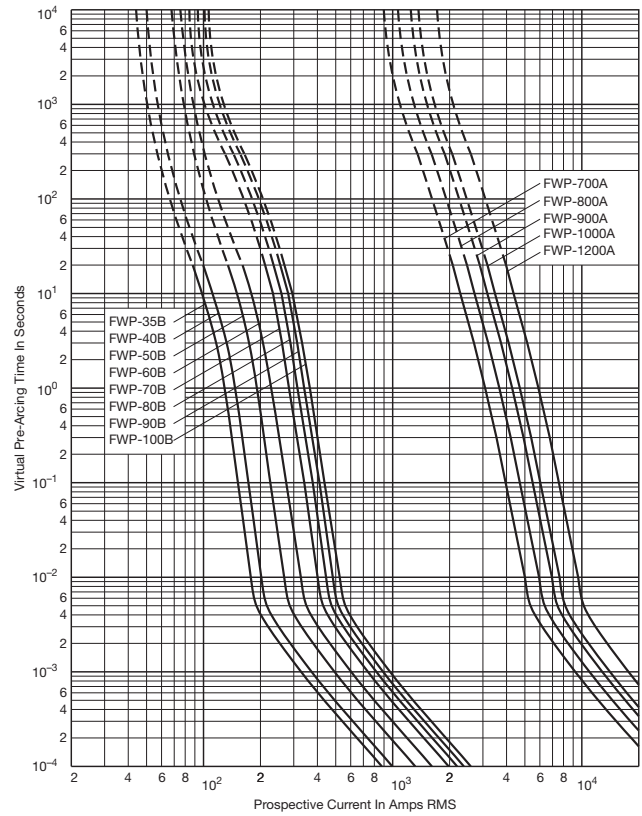

Peak Let-Through Curve

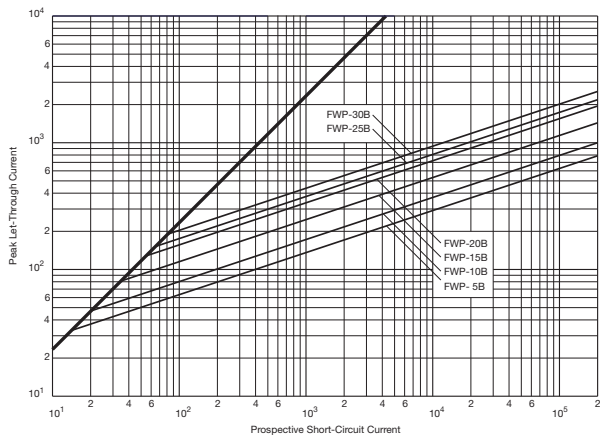

Peak Let-Through Curve

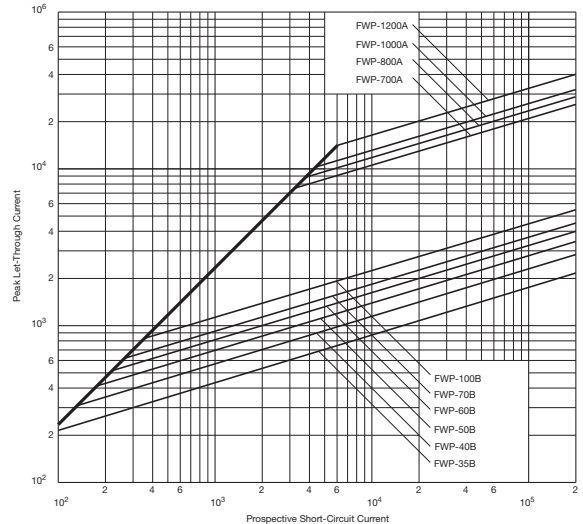

Data Sheet: 35785316

Data Sheet: 35785308

North American — FWP 700V: 5-1200A

FWP 150-600A: 700V

Time-Current Curve

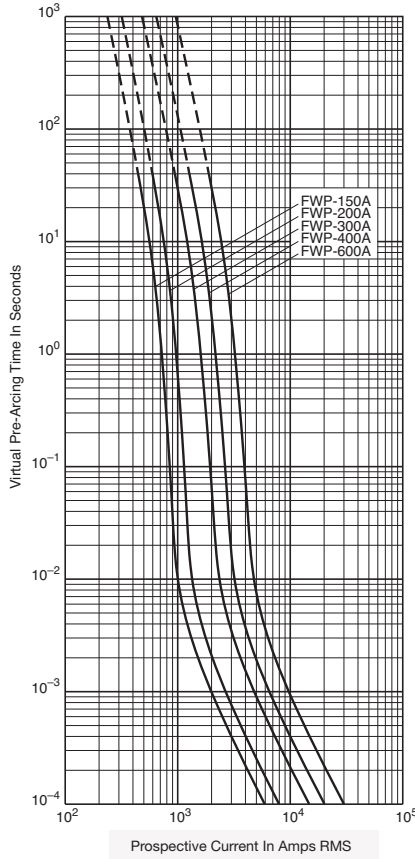

Peak Let-Through Curve

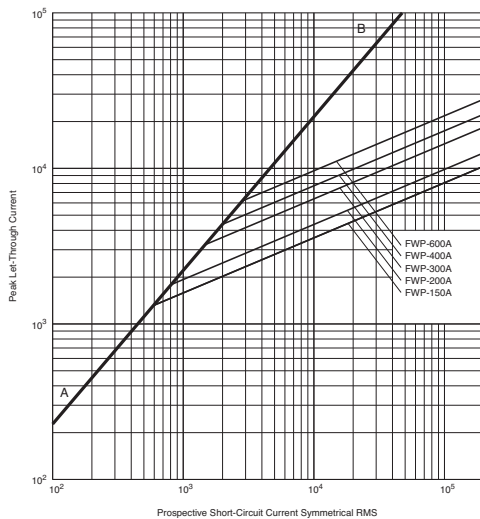

North American — FWJ 1000V: 35-2000A

FWJ

Specifications

Description: North American style stud-mount fuses.

Dimensions: See Dimensions illustration.

Ratings:

Volts: — 1000Vac/800Vdc

Amps: — 35-2000A

IR: — 25kA (35-200A)

— 100kA (250-2000A)

— 50kA @ 800Vdc
(35-200A, 450-600A)

Agency Information: CE, UL Recognition JFHR8.E91958 on 35-600A only.

Electrical Characteristics

Total Clearing I²t

The total clearing I²t at rated voltage and at power factor of 15% are given in the electrical characteristics. For other voltages, the clearing I²t is found by multiplying by correction factor, K, given as a function of applied working voltage, E_g, (rms).

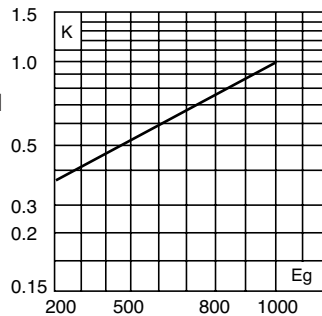

Dimensions - in

Amp Range	Fig.	A	B	C	D	E	F	G	H	I
35-60	1	5.000	0.940	3.110	4.235	4.180	0.352	0.750	0.125	0.380
70-100	1	4.932	1.125	3.085	4.266	4.156	0.352	1.000	0.188	0.407
125-200	1	5.685	1.526	3.261	4.803	4.055	0.445	1.000	0.250	0.819
250-400	1	5.768	2.000	3.500	4.811	4.150	0.433	1.500	0.250	0.764
500-600	1	7.201	2.500	3.465	5.984	4.706	0.562	2.000	0.375	1.201
800-2000	1	6.811	3.500	3.312	5.472	4.962	0.625	2.750	0.500	0.880

1mm = 0.0394" / 1" = 25.4mm

Fig. 1: 35-2000A

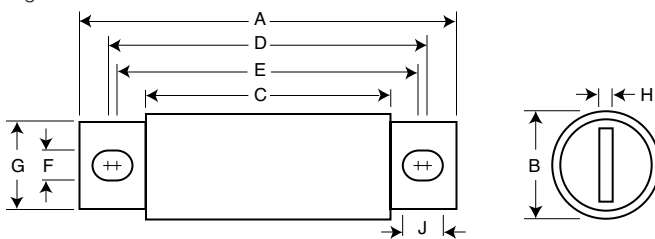

Arc Voltage

This curve gives the peak arc voltage, U_L, which may appear across the fuse during its operation as a function of the applied working voltage, E_g, (rms) at a power factor of 15%.

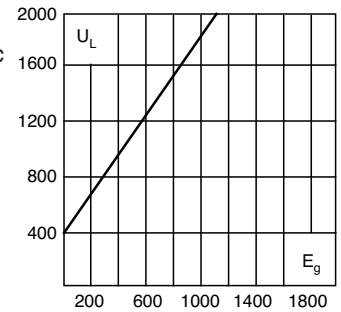

Power Losses

Watts loss at rated current is given in the electrical characteristics. The curve allows the calculation of the power losses at load currents lower than the rated current. The correction factor, K_p, is given as a function of the RMS load current, I_b, in % of the rated current.

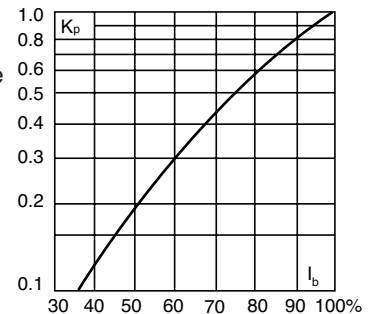

Catalog Numbers

Catalog Numbers	Rated Current RMS-Amps	Electrical Characteristics			Watts Loss
		I ² t (A ² Sec)		Clearing at 1000V	
		Pre-arc			
FWJ-35A	35	210	2000	7	
FWJ-40A	40	300	2500	8	
FWJ-50A	50	470	3500	10	
FWJ-60A	60	670	5000	11	
FWJ-70A	70	1100	6900	12	
FWJ-80A	80	1550	9700	13	
FWJ-90A	90	1900	12000	14	
FWJ-100A	100	2800	17500	15	
FWJ-125A	125	4800	35000	16	
FWJ-150A	150	6300	45000	20	
FWJ-175A	175	7500	65000	30	
FWJ-200A	200	11700	80000	32	
FWJ-250A	250	16000	112000	50	
FWJ-300A	300	23500	164000	56	
FWJ-350A	350	33000	231000	62	
FWJ-400A	400	47000	330000	67	
FWJ-500A	500	39500	329000	95	
FWJ-600A	600	61000	520000	105	
FWJ-800A	800	87000	500000	182	
FWJ-1000A	1000	190000	1100000	206	
FWJ-1200A	1200	370000	2100000	240	
FWJ-1400A	1400	470000	2700000	248	
FWJ-1600A	1600	700000	4000000	267	
FWJ-1800A	1800	925000	5300000	239	
FWJ-2000A	2000	1330000	7600000	244	

• Watts loss provided at rated current.
• See accessories on page 141.

Features and Benefits

- Excellent DC performance
- Low arc voltage and low energy let-through (I²t)
- Low watts loss
- Superior cycling capability

Typical Applications

- DC Common bus
- DC Drives
- Power converters/rectifiers
- Reduced voltage starters

Data Sheet: 720027

North American — FWJ 1000V: 35-2000A

FWJ 35-600A: 1000V

Time-Current Curve

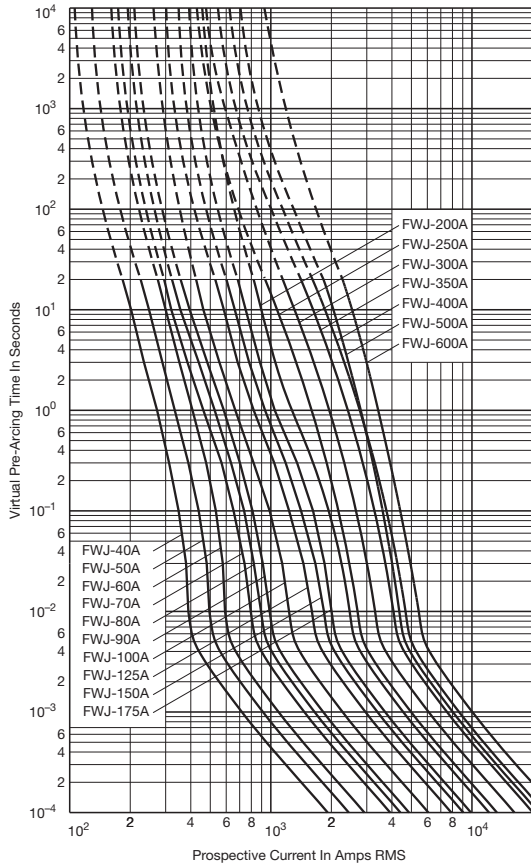

FWJ 800-2000A: 1000V

Time-Current Curve

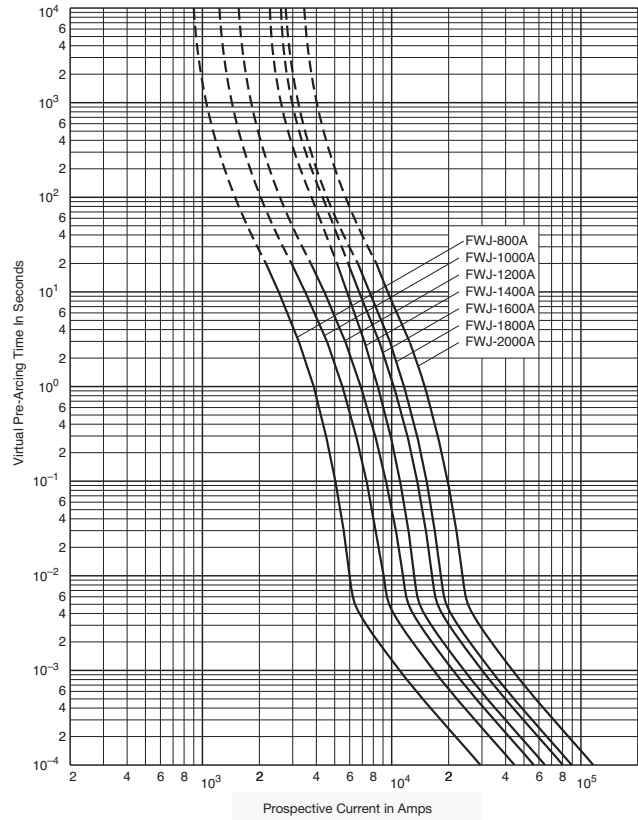

Data Sheet: 35785309

Peak Let-Through Curve

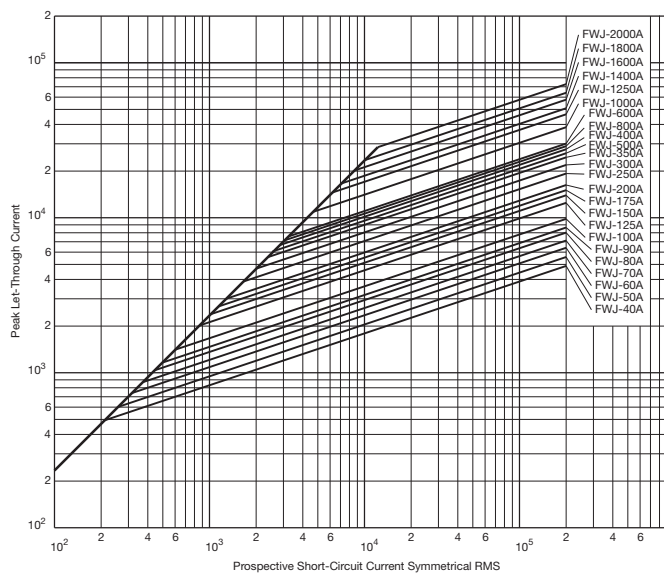

Data Sheet: 35785303

North American Fuse Accessories

Fuse Bases (Blocks)

Modular Style

Bussmann offers a comprehensive line of fuse bases that provide the user with design and manufacturing flexibility. Two identical half bases make up a Bussmann modular fuse base. These “split” units can be panel mounted any distance apart to accommodate any length fuse.

Stud Type (Not sold in pairs)

The simpler design is the C5268 Series modular fuse base. With this design, the fuse terminal and cable (with termination) are mounted on the same stud, minimizing labor needed for installation. The stud type base is available in the configuration shown in the table below.

Catalog Number	Max Fuse Amp Rating	Stud Height (in)	Stud Dia. & Threads
C5268-1	200	1.00	5/16"-18
C5268-2	200	1.75	5/16"-18
C5268-3	200	0.75	5/16"-18
C5268-4	100	1.00	1/4"-20
C5268-5	100	1.75	1/4"-20

Connector Type

Bussmann also offers a modular style fuse base that utilizes a tin-plated connector (for wire termination and heat dissipation) and a plated-steel stud (for fuse mounting). The connector type fuse base is available in the configurations shown below. Consult Bussmann for additional product details.

Modular Base Style	Max Voltage	Max Fuse Amp Rating	Data Sheet Number
1BS101	600	100	1206
1BS102	600	400	1207
1BS103	600	400	1208
1BS104	600	600	1209
BH-0xxx	700	100	1200
BH-1xxx	2500	400	1201
BH-2xxx	5000	400	1202
BH-3xxx	1250	700	1203

Refer to page 306 for BH style holders.

Fixed Center Base Style

Bussmann offers a comprehensive line of fixed mount style fuse bases under the trademark TRON™ rectifier fuse blocks. The cable and fuse connections are similar to the stud type fuse base — both are mounted on the same stud. Consult Bussmann for complete product details.

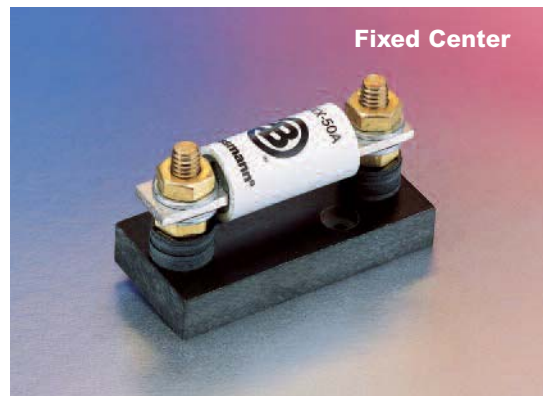
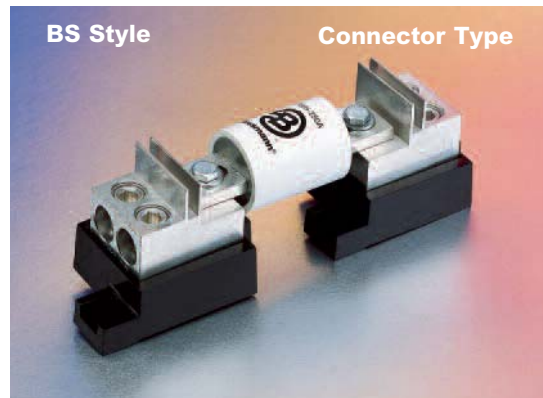
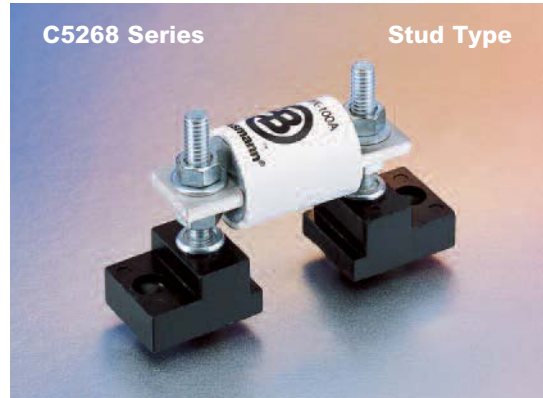

Square Body Fuses

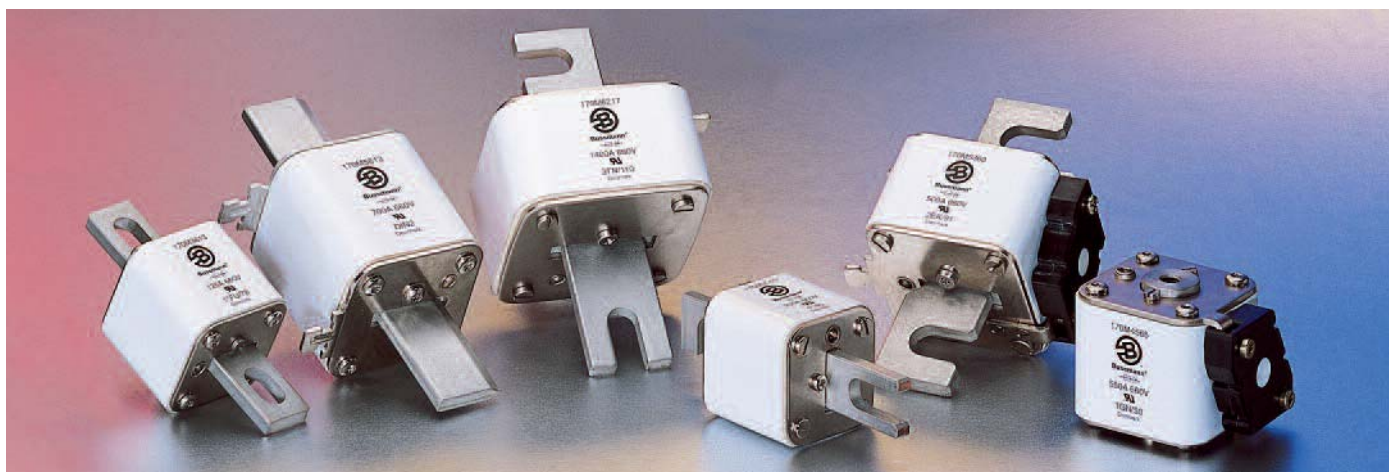

Introduction

Square Body Contents Application Information

Page
143-144

Volts (IEC/UL)	Size	Class	Fuse Style	Page	
690/700	000,00	aR	DIN 43 653	145-147	
		aR	Flush End Contact	145-147	
		aR	DIN 43 620	148-149	
	1*, 1, 2, 3	1*, 1, 2, 3	aR	DIN 43 653	150-151
			aR	Flush End Contact	152-153
			aR	US Style	154-155
		1*, 2, 3 4	aR	French Style	156-157
			aR	Fuse Curves	158-159
			aR	DIN 43 620	160-162
			aR	Flush End Contact	163-164
1000	00, 1, 2, 3 00	aR	DIN 43 620	168-171	
		aR	DIN 43 653	172-173	
	1*, 1, 2, 3	1*, 1, 2, 3	aR	DIN 43 653	174-175
			aR	Flush End Contact	176-177
			aR	US Style	178-179
			aR	Fuse Curves	180-181
			aR	Flush End Contact	182-184
	1250/1300	4 24	aR	Flush End Contact	185-186
			aR	DIN 43 653	187-188
		1*, 1, 2, 3	1*, 1, 2, 3	aR	Flush End Contact
aR				US Style	191-192
aR				Fuse Curves	193-194
1000-2000 DC Fuses		4 23 5	aR	Flush End Contact	195-197
			aR	Flush End Contact	198-199
		aR	Flush End Contact	200	
				201-211	

Accessories

Accessories	Page
Indicator System	212
Fuse Bases	213

Square Body Fuse Ranges

Amps	Volts	AC	DC
10-7500	690	X	—
50-1400	1250	X	—

General Information

Designed and tested to:

- IEC 60269: Part 4
- UL Recognized

Bussmann offers a complete range of square body style fuses and accessories. Their unique design and construction provide:

- Minimal energy let-through (I²t)
- Low operating temperature
- Low watts loss

Square body style fuses are a very attractive solution for high power applications which require a compact design with superior performance. The construction and design of square body style fuses make it easy for Bussmann to manufacture custom products. Our cataloged offering provides only a sample of the wide variety of product which is available.

Each square body style fuse is available with a number of different end fittings. Options include:

- DIN 43 653
- DIN 43 620
- Flush End (Metric/US)
- French Style
- US Style

Voltage Rating

All Bussmann square body style fuses are tested to IEC 60269: Part 4. This standard requires a test voltage which is 5% higher than the rated voltage. In North America, fuses are required to clear only their rated voltage.

Accessories

Square Body style fuses are available with three different open fuse indicator systems. Options include visual indication and indication utilizing a microswitch. Fuse blocks are also available for most applications.

Square Body Applications

Maximum Permissible Load Current

The rated current value of Bussmann fuses is based on the ambient temperature in the space immediately below the fuse of 20°C. The following graph gives correction factors (k) for a range of temperatures (-40°C to +80°C). Maximum permissible continuous load currents can be calculated by applying the following formula:

$$I_b \leq I_n \approx k \approx (1 + 0.05 V) \times K_b$$

where

I_b = Maximum permissible continuous load current

I_n = Rated current of fuse

k = Temperature correction factor

v = Velocity of cooling air in m/s (max. 5 m/s).

K_b = Fuse load constant 1.0

Temperature Correction Curve

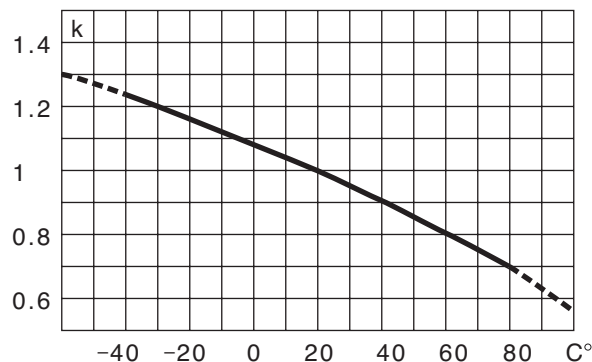

The maximum permissible continuous load current I_b of a fuse can be checked empirically (i.e., by satisfying the formula below) by making simple voltage and temperature measurements under actual operating conditions after the fuse has been installed in its operating location and loaded at the calculated I_b value:

$$\frac{E_2}{E_1} \approx (0.92 + 0.004t) \leq N$$

where

E_1 = Voltage drop across fuse after 5 seconds

E_2 = Voltage drop across fuse after 2 hours

t = Air temperature at start of test (°C)

N = Constant

Fuse Rated Voltage (IEC) N

690	1.5
1250	1.6

Body Cross Section

Standard fuse program includes barrels with different cross sections.

Size	000	00	1	1	2	3	4
Maximum Cross-section (mm)	21 × 36	30 × 47	45 × 45	53 × 53	61 × 61	76 × 76	105 × 105

Square Body Applications

Example Application of Square Body High Speed Fuses Subject to Overload and Impulse Loading

Select a short-blade indicating fuse with indicator/adaptor to permit the use of a single-pole microswitch for remote indication and determine if the fuse selected will meet the following application parameters.

Application Parameters

Load Currents Expected

Load Type	Duration	Frequency of Occurrence	Amps
(1) Normal	Continuous	—	300A
(2) Overload	60 Seconds	Once Per Hour	500A
(3a) Overload	10 Seconds	2-3 Times Per Week	700A
(3b) Overload	20 Seconds (max.)	Once Per Month	
(4) Impulse	0.5 Seconds	Less Than Once Per Month	1100A

Voltage Data

(5) Voltage Applied to Fuse During Fault Conditions (+10%)	400V
--	------

Temperature Data

(6) Temperature Inside Cubicle in Which Fuse is Located (Natural Convection Cooling Only)	60°C
---	------

Thyristor Data

(7) Thyristor Peak Voltage Withstand	1000V
(8) Thyristor I ^t Withstand at 10 Milliseconds*	90,000A ² s

*Note: The I^t withstand of the thyristor may be given for other impulse durations (i.e., 1.5 ms, 3.5 ms, or 8.3 ms); however, the stated fuse I^t is valid for all impulse durations of 10 ms or less.

Application Procedure

Step	Procedure	Remarks
(1) Select a short-blade fuse to permit mounting of microswitch 170H0069	1.1 Taking into consideration only the continuous load current and ambient temperature, from Table on page 127 tentatively select fuse 170M3669 (400A, 690V).	—
(2) Determine I ^t (total clearing) at 440V.	2.1 See Table, page 127. Note I ^t is 105,000A ² s at rated voltage of 690V. 2.2 From the figure on page 126, note that correction factor K = 0.65. 2.3 I ^t _{660V} × K = I ^t _{440V} 105,000 × 0.65 = 68,250	OK
(3) Determine maximum arc voltage at 440V	3.1 From the figure on page 126, note that maximum voltage at 440V is 900V	OK
(4) Determine maximum permissible continuous load current I _b .	4.1 Per page 115 data, I _b = I _n × k × (1 + 0.05V) × K _p I _b = 400A × 0.8 × (1 + 0) × 1 I _b = 320A	—
(5) Plot a "line profile" showing the expected load and overload currents. Determine that overload and impulse load currents do not exceed their maximum permissible values.	5.0 Calculate I _{max} per Table, High Speed Fuse Application Guide page 16, for each overload and impulse load.	—
(Item 2)	5.1 I _{max} < 60% × I _t 500A < 60% × 950A 500A < 570A	OK
(Item 3a)	5.2 I _{max} < 60% × I _t 700A < 60% × 1360A 700A < 780A	OK
(Item 3b)	5.3 I _{max} < 70% × I _t 700A < 70% × 1150A 700A < 805A	OK
(Item 4)	5.4 I _{max} < 70% × I _t 1100A < 70% × 1800A 1100A < 1260A	OK

The tentatively selected fuse 170M3669 with microswitch 170H0069 meets all application parameters; no further selection would be necessary.

170M3669 (400A)

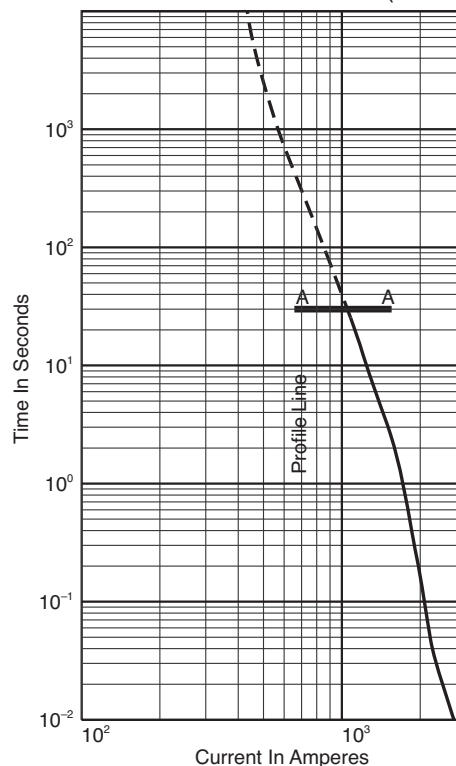

Calculation of Watt Loss

From the Table on page 127, watt loss at 400 amps is 60 watts. The continuous load current of 300A is 75% of rated current (400A). From page 126, the correction factor $K_p = 0.5$.

$$\begin{aligned} \text{Watt Loss } 75\% &= \text{Watt Loss } 100\% \times K_p \\ &= 60W \times 0.5 \\ &= 30 \text{ watts} \end{aligned}$$

Special Fuses

Other high speed fuses are available from Bussmann with voltage ratings of 380 to 10,000V and current ratings up to 10,000A in a single unit configuration. Fuses can be supplied with open fuse, "pin" indicators. Various types of microswitches are also available (see page 212).

Square Body DIN 43 653 — 690V/700V (IEC/UL): 10-400A

690V/700V (IEC/UL) 10-400A

Specifications

Description: Square body DIN 43-653 stud mount high speed fuses.

Dimensions: See dimensions illustration.

Ratings:

Volts: — 690Vac (IEC)
— 700Vac (UL)

Amps: — 10-400A

IR: — 200kA RMS Sym.

Agency Information: CE, Designed and tested to IEC 60269: Part 4. UL Recognized E125085.JFHR2, CSA Certified: Class 53787, File 1422-30 on Size 000.

Electrical Characteristics

Total Clearing I^2t

The total clearing I^2t at rated voltage and at power factor of 15% are given in the electrical characteristics. For other voltages, the clearing I^2t is found by multiplying by correction factor, K, given as a function of applied

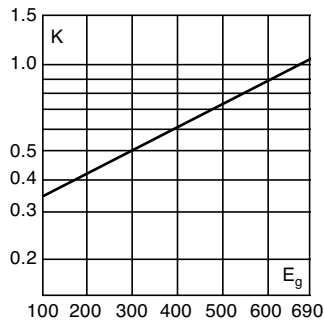

Dimensions - mm

Type -U/80, -/80, -TN/80

Size	D	E	F	G	H	K
000	40	21	20	51	8	2
00	51	30	28	67	10	2

1mm = 0.0394" / 1" = 25.4mm

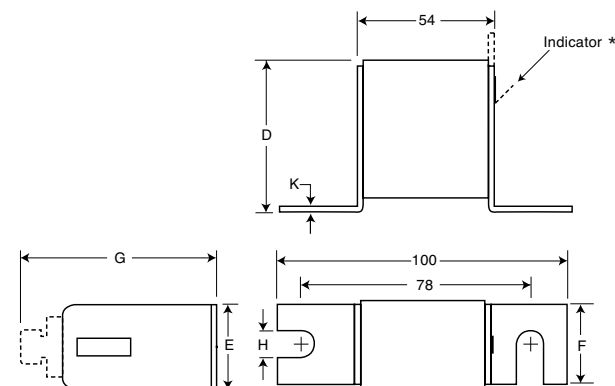

* Indication for Size 00 fuses is a red pin.



working voltage, E_g , (rms).

Arc Voltage

This curve gives the peak arc voltage, U_L , which may appear across the fuse during its operation as a function of the applied working voltage, E_g , (rms) at a power factor of 15%.

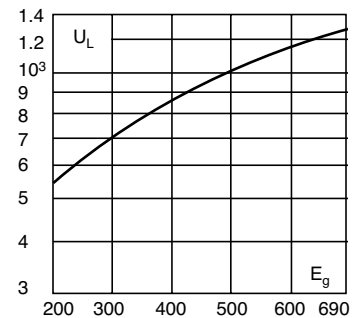

Power Losses

Watts loss at rated current is given in the electrical characteristics. The curve allows the calculation of the power losses at load currents lower than the rated current. The correction factor, K_p , is given as a function of the RMS load current, I_b , in % of the rated current.

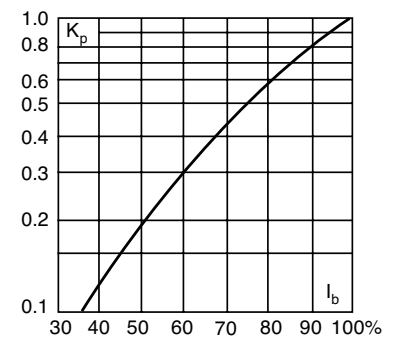

Features and Benefits

- Excellent DC performance
- Low arc voltage and low energy let-through (I^2t)
- Low watts loss
- Superior cycling capability

Typical Applications

- DC Common bus
- DC Drives
- Power converters/rectifiers

For Other Voltage Ratings in This Body Style

- See page 172 (1000V)

Dimensions (mm)

Type 00B/60, 00BTN/60

1mm = 0.0394" / 1" = 25.4mm

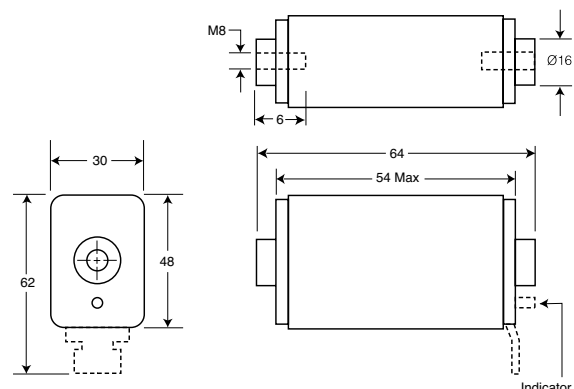

Square Body DIN 43 653 — 690V/700V (IEC/UL): 10-400A

Catalog Numbers

Catalog Numbers					Size	Electrical Characteristics			
-U/80 Without Indicator	-/80 Visual Indicator	-TN/80 Type T Indicator for Micro	00B/60 Visual Indicator	00BTN/60 Type T Indicator for Micro		Rated Current RMS-Amps	I ² t (A ² Sec)		Watts Loss
							Pre-arc	Clearing at 660V	
170M1308	170M1358	170M1408			10	3.8	25.5	3.0	
170M1309	170M1359	170M1409			16	7.2	48	5.5	
170M1310	170M1360	170M1410			20	11.5	78	7	
170M1311	170M1361	170M1411			25	19	130	9	
170M1312	170M1362	170M1412			32	40	270	10	
170M1313	170M1363	170M1413			40	69	460	12	
170M1314	170M1364	170M1414			50	115	770	15	
170M1315	170M1365	170M1415			63	215	1450	16	
170M1316	170M1366	170M1416			80	380	2550	19	
170M1317	170M1367	170M1417			100	695	4650	24	
170M1318	170M1368	170M1418			125	1200	8500	28	
170M1319	170M1369	170M1419			160	2300	16000	32	
170M1320	170M1370	170M1420			200	4200	28000	37	
170M1321	170M1371	170M1421			250	7750	51500	42	
170M1322	170M1372	170M1422			315	12000	80500	52	
	170M2608	170M2658	170M2708	170M2758	25	19	130	6	
	170M2609	170M2659	170M2709	170M2759	32	28.5	195	7	
	170M2610	170M2660	170M2710	170M2760	40	50	360	9	
	170M2611	170M2661	170M2711	170M2761	50	95	640	10	
	170M2612	170M2662	170M2712	170M2762	63	170	1200	12	
	170M2613	170M2663	170M2713	170M2763	80	310	2100	15	
	170M2614	170M2664	170M2714	170M2764	100	620	4150	20	
	170M2615	170M2665	170M2715	170M2765	125	1000	6950	25	
	170M2616	170M2666	170M2716	170M2766	160	1900	13000	30	
	170M2617	170M2667	170M2717	170M2767	200	3400	23000	35	
	170M2618	170M2668	170M2718	170M2768	250	6250	42000	45	
	170M2619	170M2669	170M2719	170M2769	315	10000	68500	55	
	170M2620	170M2670	170M2720	170M2770	350	13500	91500	60	
	170M2621	170M2671	170M2721	170M2771	400	18000	125000	70	

- Watts loss provided at rated current.
- Microswitch indicator ordered separately.
- See accessories on pages 212-213.
- For fuse curves see page 147.

Square Body Size 000, 00 — 690V/700V (IEC/UL): 10-400A

Size 000 — 10-315A: 690V

Time-Current Curve

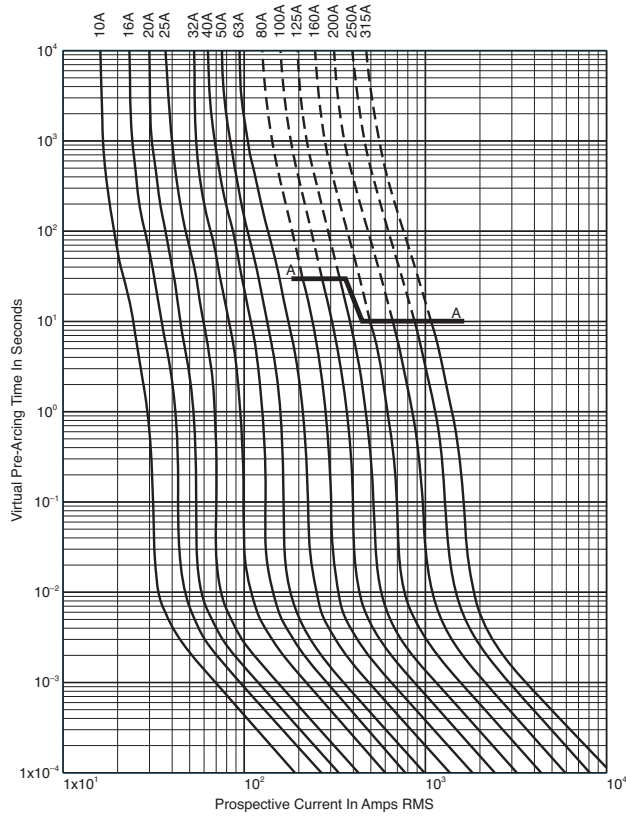

Size 00 — 25-400A: 690V

Time-Current Curve

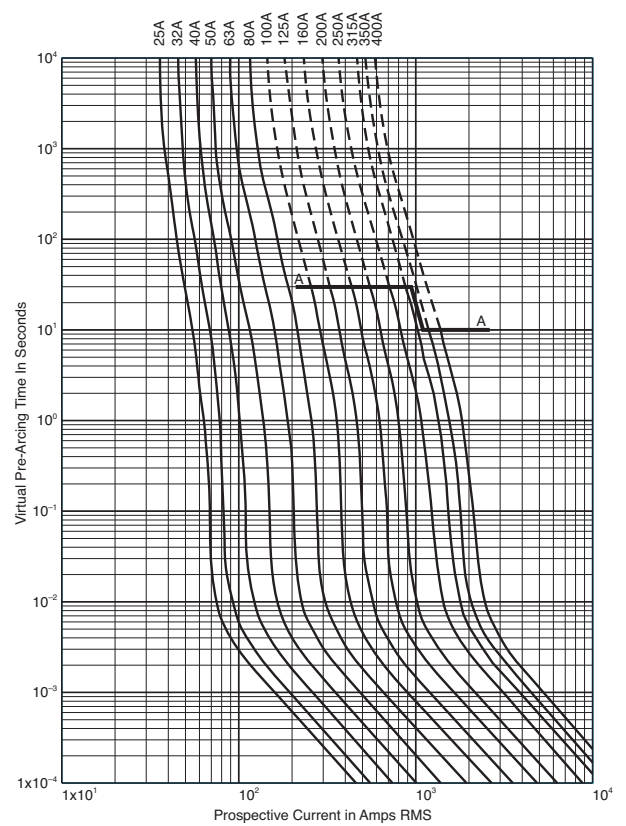

Peak Let-Through Curve

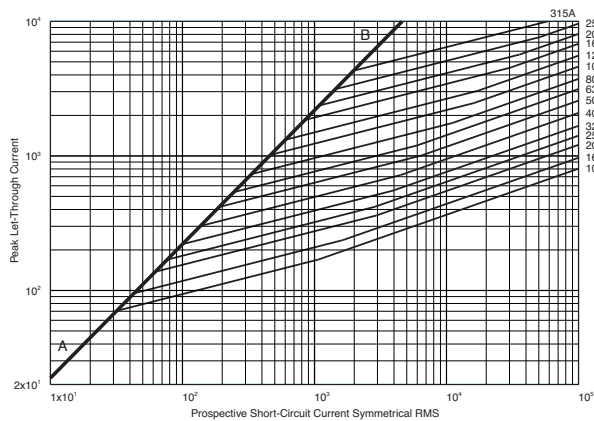

Peak Let-Through Curve

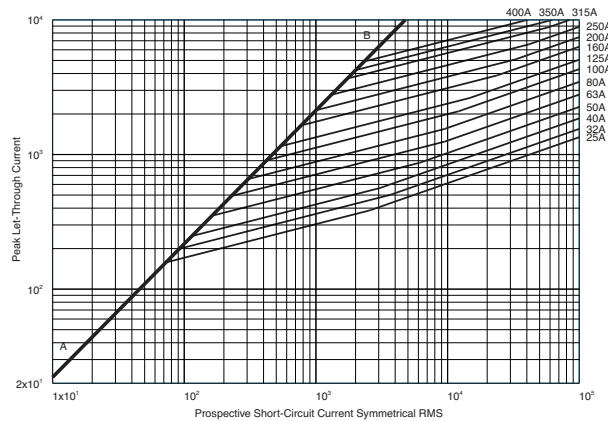

Data Sheet: 17056310

Data Sheet: 172056312

Square Body DIN 43 620 — 690V (IEC/UL): 10-315A

690V (IEC/UL) 10-315A

Specifications

Description: Square body DIN 43 620 blade style high speed fuses.

Dimensions: See dimensions illustration.

Ratings:

Volts: — 690Vac

Amps: — 10-315A

IR: — 200kA RMS Sym.

Agency Information: CE, Designed and tested to IEC 60269: Part 4. UL Recognized E125085.JFHR2. & CSA Component Acceptance file Class 1422-30, (53787)

Electrical Characteristics

Total Clearing I^2t

The total clearing I^2t at rated voltage and at power factor of 15% are given in the electrical characteristics. For other voltages, the clearing I^2t is found by multiplying by correction factor, K, given as a function of applied working voltage, E_g , (rms).

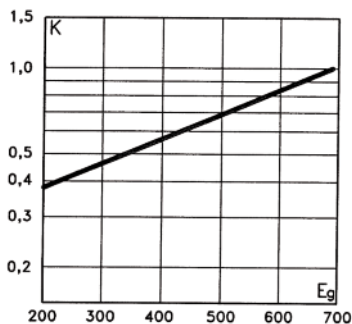

Arc Voltage

This curve gives the peak arc voltage, U_L , which may appear across the fuse during its operation as a function of the applied working voltage, E_g , (rms) at a power factor of 15%.

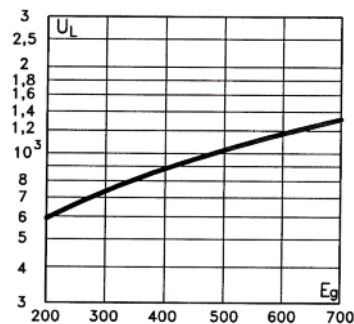

Power Losses

Watts loss at rated current is given in the electrical characteristics. The curve allows the calculation of the power losses at load currents lower than the rated current. The correction factor, K_p , is given as a function of the RMS load current, I_b , in % of the rated current.

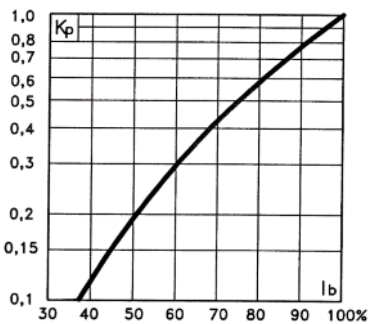

Features and Benefits

- Excellent DC performance
- Low arc voltage and low energy let-through (I^2t)
- Low watts loss
- Superior cycling capability

Typical Applications

- DC Common bus
- DC Drives
- Power converters/rectifiers
- Reduced voltage starters

Dimensions - mm

DIN 000 Type T

1mm = 0.0394" / 1" = 25.4mm

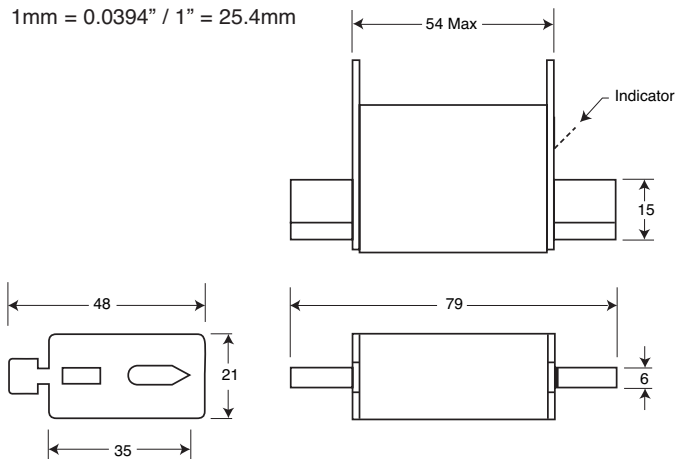

Square Body DIN 43 620 — 690V (IEC/UL): 10-315A

Catalog Numbers

Catalog Numbers DIN Type T Indicator for Micro	Size	Electrical Characteristics				
		Rated Current RMS-Amps	I ² t (A ² Sec)		Watts Loss	
			Pre-arc	Clearing at 660V		
170M1558D	000	10	4	27	2.5	
170M1559D		16	7	51	4	
170M1560D		20	11.5	82.5	5	
170M1561D		25	19	140	6	
170M1562D		32	40	285	7	
170M1563D		40	65	490	8.5	
170M1564D		50	115	815	9.5	
170M1565D		63	215	1550	11.5	
170M1566D		80	380	2700	15	
170M1567D		100	695	4950	16.5	
170M1568D		125	1180	8250	21.5	
170M1569D		160	2300	16500	25	
170M1570D		200	4350	31000	29.5	
170M1571D		250	7900	56000	35.5	
170M1572D		00	315	12000	84500	45

- Watts loss provided at rated current.
- Microswitch indicator ordered separately. See accessories on pages 212-213.

Rated Current

The rated current of this fuse range has been given with copper conductors that have a current density of 1.3A/mm² (IEC 60269-4). For conductor cross section according to IEC 60269-1, the fuses with a rated current higher than 125A must be derated. Please contact Bussmann for application assistance.

Size 000 — 10-315A: 690V Time-Current Curve

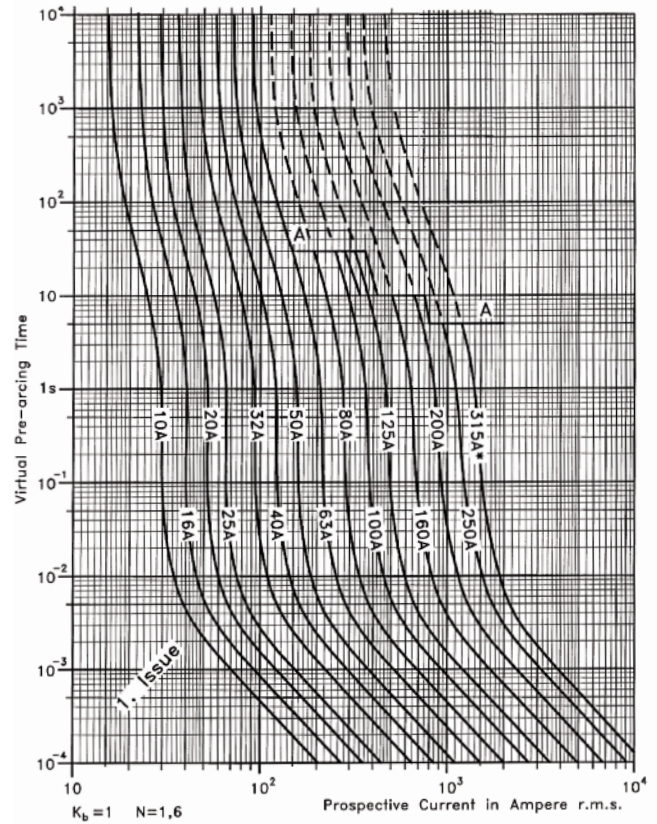

Peak Let-Through Curve

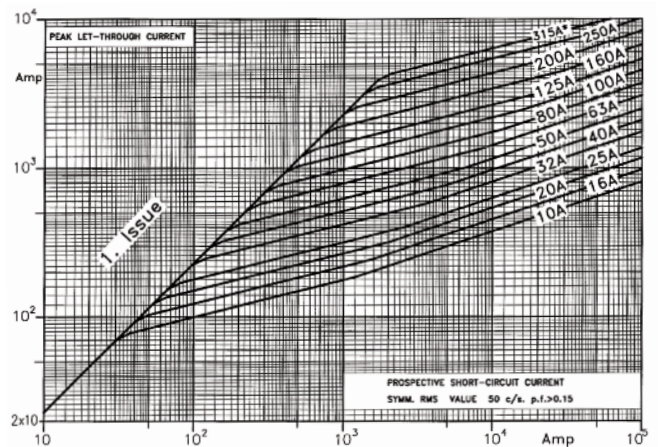

Data Sheet: 72056310

Square Body DIN 43 653 — 690V/700V (IEC/UL): 40-2000A

690V/700V (IEC/UL) 40-2000A

Specifications

Description: Square body DIN 43 653 stud-mount high speed fuses.

Dimensions: See dimensions illustration.

Ratings:

Volts: — 690Vac (IEC)

— 700Vac (UL)

Amps: — 40-2000A

IR: — 200kA RMS Sym.

Agency Information: CE, Designed and tested to IEC 60269: Part 4. UL Recognized E125085.JFHR2, CSA Certified: Class 53787, File 1422-30.

Electrical Characteristics

Total Clearing I²t

The total clearing I²t at rated voltage and at power factor of 15% are given in the electrical characteristics. For other voltages, the clearing I²t is found by multiplying by correction factor, K, given as a function of applied working voltage, E_g, (rms).

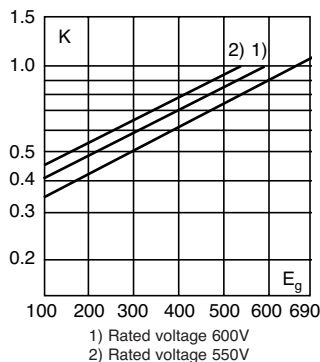

Dimensions - mm

Size	A	B	B**	C	C**	D***	E	H
1*	50	104	134	78	108	58	45	22
1	50	108	138	78	108	66	53	25
2	50	108	138	78	108	75	61	25
3	51	109	139	78	108	90	76	30

**Valid for fuses type -/110, -TN/110.

***Microswitch.

1mm = 0.0394" / 1" = 25.4mm

Type -/80, -TN/80, -/110, -TN/110.

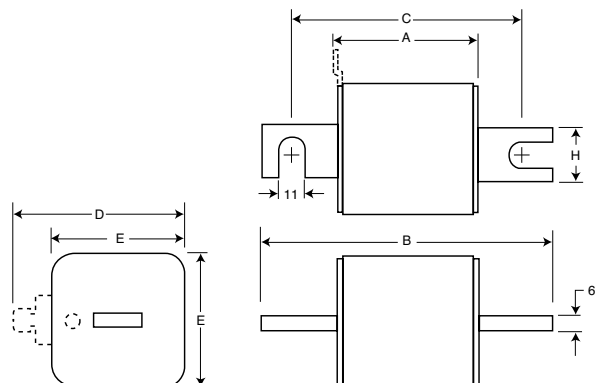

Arc Voltage

This curve gives the peak arc voltage, U_L, which may appear across the fuse during its operation as a function of the applied working voltage, E_g, (rms) at a power factor of 15%.

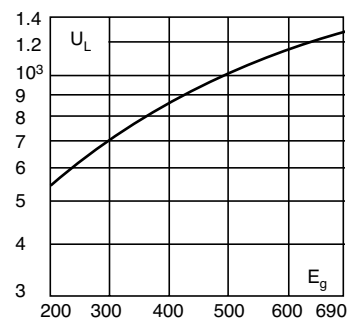

Power Losses

Watts loss at rated current is given in the electrical characteristics. The curve allows the calculation of the power losses at load currents lower than the rated current. The correction factor, K_p, is given as a function of the RMS load current, I_b, in % of the rated current.

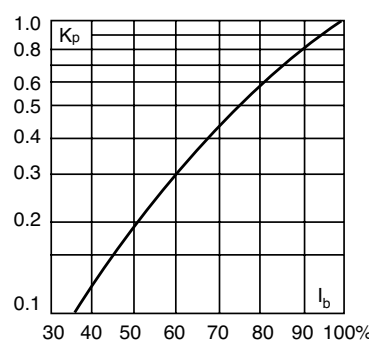

Features and Benefits

- Excellent DC performance
- Low arc voltage and low energy let-through (I²t)
- Low watts loss
- Superior cycling capability

Typical Applications

- DC Common bus
- DC Drives
- Power converters/rectifiers
- Reduced voltage starters

For Other Voltage Ratings in This Body Style

- See pages 174 (1000V) and 187 (1250V/1300V)

Type -KN/80, -KN/110

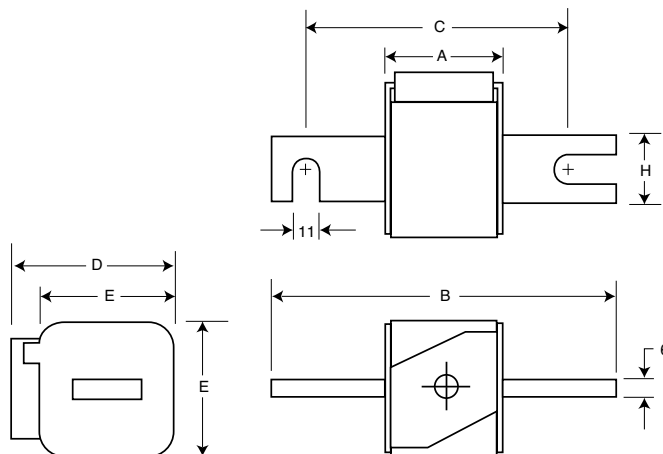

Square Body DIN 43 653 — 690V/700V (IEC/UL): 40-2000A

Catalog Numbers

Catalog Numbers						Size	Electrical Characteristics			
-/80 Visual Watts Indicator	-TN/80 Type T Indicator for Micro	-KN/80 Type K Indicator for Micro	-/110 Visual for Micro	-TN/110 Type T Indicator for Micro	-KN/110 Type K Indicator -KN/80		Rated RMS-Amps	I ² t (A ² Sec)		Clearing Loss
								Current Pre-arc	at 660V	
170M3008	170M3058	170M3108	170M3158	170M3208	170M3258	1*	40	40	270	9
170M3009	170M3059	170M3109	170M3159	170M3209	170M3259		50	77	515	11
170M3010	170M3060	170M3110	170M3160	170M3210	170M3260		63	115	770	14
170M3011	170M3061	170M3111	170M3161	170M3211	170M3261		80	185	1250	18
170M3012	170M3062	170M3112	170M3162	170M3212	170M3262		100	360	2450	21
170M3013	170M3063	170M3113	170M3163	170M3213	170M3263		125	550	3700	26
170M3014	170M3064	170M3114	170M3164	170M3214	170M3264		160	1100	7500	30
170M3015	170M3065	170M3115	170M3165	170M3215	170M3265		200	2200	15000	35
170M3016	170M3066	170M3116	170M3166	170M3216	170M3266		250	4200	28500	40
170M3017	170M3067	170M3117	170M3167	170M3217	170M3267		315	7000	46500	50
170M3018	170M3068	170M3118	170M3168	170M3218	170M3268		350	10000	68500	55
170M3019	170M3069	170M3119	170M3169	170M3219	170M3269		400	15000	105000	60
170M3020	170M3070	170M3120	170M3170	170M3220	170M3270		450	21000	140000	65
170M3021	170M3071	170M3121	170M3171	170M3221	170M3271		500	27000	180000	70
170M3022	170M3072	170M3122	170M3172	170M3222	170M3272		550	34000	230000	75
170M3023	170M3073	170M3123	170M3173	170M3223	170M3273		630	48500	325000	80
170M4008	170M4058	170M4108	170M4158	170M4208	170M4258		1	200	1650	11500
170M4009	170M4059	170M4109	170M4159	170M4209	170M4259	250		3100	21000	55
170M4010	170M4060	170M4110	170M4160	170M4210	170M4260	315		6200	42000	58
170M4011	170M4061	170M4111	170M4161	170M4211	170M4261	350		8500	59000	60
170M4012	170M4062	170M4112	170M4162	170M4212	170M4262	400		13500	91500	65
170M4013	170M4063	170M4113	170M4163	170M4213	170M4263	450		17000	120000	70
170M4014	170M4064	170M4114	170M4164	170M4214	170M4264	500		25000	170000	72
170M4015	170M4065	170M4115	170M4165	170M4215	170M4265	550		34000	230000	75
170M4016	170M4066	170M4116	170M4166	170M4216	170M4266	630		52000	350000	80
170M4017	170M4067	170M4117	170M4167	170M4217	170M4267	700		69500	465000	85
170M4018	170M4068	170M4118	170M4168	170M4218	170M4268	800		105000	725000	95
170M4019	170M4069	170M4119	170M4169	170M4219	170M4269	±900		155000	±850000	100
170M5008	170M5058	170M5108	170M5158	170M5208	170M5258	2	400	11000	74000	65
170M5009	170M5059	170M5109	170M5159	170M5209	170M5259		450	15500	105000	70
170M5010	170M5060	170M5110	170M5160	170M5210	170M5260		500	21500	145000	75
170M5011	170M5061	170M5111	170M5161	170M5211	170M5261		550	28000	190000	80
170M5012	170M5062	170M5112	170M5162	170M5212	170M5262		630	41000	275000	90
170M5013	170M5063	170M5113	170M5163	170M5213	170M5263		700	60500	405000	95
170M5014	170M5064	170M5114	170M5164	170M5214	170M5264		800	86000	575000	105
170M5015	170M5065	170M5115	170M5165	170M5215	170M5265		900	125000	840000	110
170M5016	170M5066	170M5116	170M5166	170M5216	170M5266		1000	180000	1250000	115
170M5017	170M5067	170M5117	170M5167	170M5217	170M5267		1100	245000	1600000	120
170M5018	170M5068	170M5118	170M5168	170M5218	170M5268		1250	365000	2400000	130
170M6008	170M6058	170M6108	170M6158	170M6208	170M6258		3	500	14000	95000
170M6009	170M6059	170M6109	170M6159	170M6209	170M6259	550		19500	135000	100
170M6010	170M6060	170M6110	170M6160	170M6210	170M6260	630		31000	210000	105
170M6011	170M6061	170M6111	170M6161	170M6211	170M6261	700		44500	300000	110
170M6012	170M6062	170M6112	170M6162	170M6212	170M6262	800		69500	465000	115
170M6013	170M6063	170M6113	170M6163	170M6213	170M6263	900		100000	670000	120
170M6014	170M6064	170M6114	170M6164	170M6214	170M6264	1000		140000	945000	125
170M6015	170M6065	170M6115	170M6165	170M6215	170M6265	1100		190000	1300000	130
170M6016	170M6066	170M6116	170M6166	170M6216	170M6266	1250		290000	1950000	140
170M6017	170M6067	170M6117	170M6167	170M6217	170M6267	1400		370000	2450000	155
170M6018	170M6068	170M6118	170M6168	170M6218	170M6268	1500		460000	3100000	160
170M6019	170M6069	170M6119	170M6169	170M6219	170M6269	1600		580000	3900000	160
170M6020	170M6070	170M6120	170M6170	170M6220	170M6270	†1800		880000	†5250000	165
170M6021	170M6071	170M6121	170M6171	170M6221	170M6271	±2000	1150000	±6350000	175	

†Rated voltage (IEC) 600V.

‡Rated voltage (IEC) 550V.

• Watts loss provided at rated current.

• Microswitch indicator ordered separately. See accessories on pages 212-213.

• For fuse curves see pages 158 and 159.

Square Body Flush End Contact — 690V/700V (IEC/UL): 40-2000A

690V/700V (IEC/UL) 40-2000A

Specifications

Description: Square body flush end contact high speed fuses.

Dimensions: See dimensions illustrations.

Ratings:

Volts: — 690Vac (IEC)

— 700Vac (UL)

Amps: — 40-2000A

IR: — 200kA RMS Sym.

Agency Information: CE, Designed and tested to IEC 60269: Part 4. UL Recognized E125085.JFHR2, CSA Certified: Class 53787, File 1422-30.

Electrical Characteristics

Total Clearing I²t

The total clearing I²t at rated voltage and at power factor of 15% are given in the electrical characteristics. For other voltages, the clearing I²t is found by multiplying by correction factor, K, given as a function of applied working voltage, E_g, (rms).

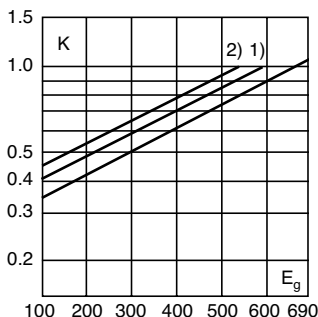

1) Rated voltage 600V.
2) Rated voltage 550V



Arc Voltage

This curve gives the peak arc voltage, U_L, which may appear across the fuse during its operation as a function of the applied working voltage, E_g, (rms) at a power factor of 15%.

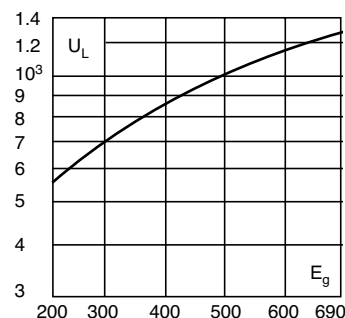

Power Losses

Watts loss at rated current is given in the electrical characteristics. The curve allows the calculation of the power losses at load currents lower than the rated current. The correction factor, K_p, is given as a function of the RMS load current, I_b, in % of the rated current.

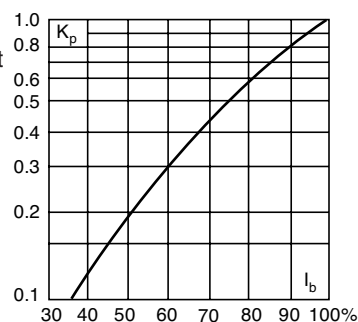

Features and Benefits

- Excellent DC performance
- Low arc voltage and low energy let-through (I²t)
- Low watts loss
- Superior cycling capability

Typical Applications

- DC Common bus
- DC Drives
- Power converters/rectifiers
- Reduced voltage starters

For Other Voltage Ratings in This Body Style

- See pages 176 (1000V) and 189 (1250V/1300V)

Dimensions - mm

Type -B/-, -BKN/-, -G/-, -GKN/-

Size	A	B	D	E	F	F** (in)	G	H
1*	50	51	59	45	M8	3/16" - 18 UNC-2B	5	ø17
1	50	51	69	53	M8	3/16" - 18 UNC-2B	8	ø20
2	50	51	77	61	M10	3/16" - 16 UNC-2B	10	ø24
3	51	53	92	76	M12	1/2" - 13 UNC-2B	10	ø30

**Valid for fuses type -G/- & -GKN/-.

NB: B = 65 for: Size 2, 1100-1250A

Size 3, 1600-2000A

1mm = 0.0394" / 1" = 25.4mm

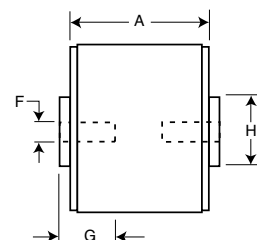
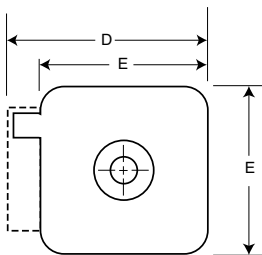
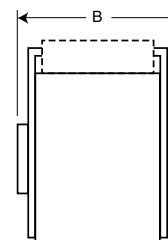

Square Body Flush End Contact — 690V/700V (IEC/UL): 40-2000A

Catalog Numbers

Catalog Numbers				Size	Electrical Characteristics			
-B/- Visual Indicator	-BKN/ Type K Indicator for Micro	-G/- Visual Indicator	-GKN/ Type K Indicator for Micro		Rated Current RMS-Amps	I ² t (A ² Sec)		Watts Loss
						Pre-arc	Clearing at 660V	
170M3408	170M3458	170M3508	170M3558	1*	40	40	270	9
170M3409	170M3459	170M3509	170M3559		50	77	515	11
170M3410	170M3460	170M3510	170M3560		63	115	770	14
170M3411	170M3461	170M3511	170M3561		80	185	1250	18
170M3412	170M3462	170M3512	170M3562		100	360	2450	21
170M3413	170M3463	170M3513	170M3563		125	550	3700	26
170M3414	170M3464	170M3514	170M3564		160	1100	7500	30
170M3415	170M3465	170M3515	170M3565		200	2200	15000	35
170M3416	170M3466	170M3516	170M3566		250	4200	28500	40
170M3417	170M3467	170M3517	170M3567		315	7000	46500	50
170M3418	170M3468	170M3518	170M3568		350	10000	68500	55
170M3419	170M3469	170M3519	170M3569		400	15000	105000	60
170M3420	170M3470	170M3520	170M3570		450	21000	140000	65
170M3421	170M3471	170M3521	170M3571		500	27000	180000	70
170M3422	170M3472	170M3522	170M3572		550	34000	230000	75
170M3423	170M3473	170M3523	170M3573		630	48500	325000	80
170M4408	170M4458	170M4508	170M4558		1	200	1650	11500
170M4409	170M4459	170M4509	170M4559	250		3100	21000	55
170M4410	170M4460	170M4510	170M4560	315		6200	42000	58
170M4411	170M4461	170M4511	170M4561	350		8500	59000	60
170M4412	170M4462	170M4512	170M4562	400		13500	91500	65
170M4413	170M4463	170M4513	170M4563	450		17000	120000	70
170M4414	170M4464	170M4514	170M4564	500		25000	170000	72
170M4415	170M4465	170M4515	170M4565	550		34000	230000	75
170M4416	170M4466	170M4516	170M4566	630		52000	350000	80
170M4417	170M4467	170M4517	170M4567	700		69500	465000	85
170M4418	170M4468	170M4518	170M4568	800		105000	725000	95
170M4419	170M4469	170M4519	170M4569	†900	155000	†850000	100	
170M5408	170M5458	170M5508	170M5558	2	400	11000	74000	65
170M5409	170M5459	170M5509	170M5559		450	15500	105000	70
170M5410	170M5460	170M5510	170M5560		500	21500	145000	75
170M5411	170M5461	170M5511	170M5561		550	28000	190000	80
170M5412	170M5462	170M5512	170M5562		630	41000	275000	90
170M5413	170M5463	170M5513	170M5563		700	60500	405000	95
170M5414	170M5464	170M5514	170M5564		800	86000	575000	105
170M5415	170M5465	170M5515	170M5565		900	125000	840000	110
170M5416	170M5466	170M5516	170M5566		1000	180000	1250000	115
170M5417	170M5467	170M5517	170M5567		1100	245000	1600000	120
170M5418	170M5468	170M5518	170M5568		1250	365000	2400000	130
170M6408	170M6458	170M6508	170M6558	3	500	14000	95000	95
170M6409	170M6459	170M6509	170M6559		550	19500	135000	100
170M6410	170M6460	170M6510	170M6560		630	31000	210000	105
170M6411	170M6461	170M6511	170M6561		700	44500	300000	110
170M6412	170M6462	170M6512	170M6562		800	69500	465000	115
170M6413	170M6463	170M6513	170M6563		900	100000	670000	120
170M6414	170M6464	170M6514	170M6564		1000	140000	945000	125
170M6415	170M6465	170M6515	170M6565		1100	190000	1300000	130
170M6416	170M6466	170M6516	170M6566		1250	290000	1950000	140
170M6417	170M6467	170M6517	170M6567		1400	370000	2450000	155
170M6418	170M6468	170M6518	170M6568		1500	460000	3100000	160
170M6419	170M6469	170M6519	170M6569		1600	580000	3900000	160
170M6420	170M6470	170M6520	170M6570		†1800	880000	†5250000	165
170M6421	170M6471	170M6521	170M6571		‡2000	1150000	‡6350000	175

†Rated voltage (IEC) 600V.

‡Rated voltage (IEC) 550V.

• Watts loss provided at rated current.

• Microswitch indicator ordered separately. See accessories on pages 212-213.

• For fuse curves see pages 158 and 159.

Square Body US Style — 690V/700V (IEC): 40-2000A

690V/700V (IEC) 40-2000A

Specifications

Description: Square body US style high speed fuses.

Dimensions: See dimensions illustration.

Ratings:

Volts: — 690Vac (IEC)
— 700Vac (UL)

Amps: — 40-200A

IR: — 200kA RMS Sym.

Agency Information: CE, Designed and tested to IEC 60269: Part 4. UL Recognized E125085.JFHR2, CSA Certified: Class 53787, File 1422-30.

Electrical Characteristics

Total Clearing I²t

The total clearing I²t at rated voltage and at power factor of 15% are given in the electrical characteristics. For other voltages, the clearing I²t is found by multiplying by correction factor, K, given as a function of applied working voltage, E_g, (rms).

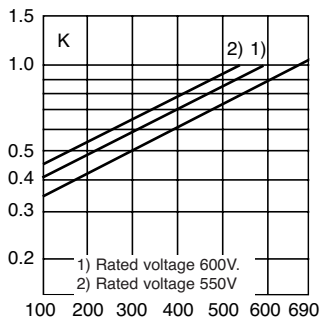

Dimensions - mm

Type -FU/-, -FKE/-, FU/115-, -FKE/115

Size	A	B	B**	C1	C1**	C2	C2**	D	E	H	I
1*	50	110	148	85	123	72	110	59	45	20	10
1	50	136	157	104	126	78	100	69	53	25	14
2	50	135	159	105	125	78	99	77	61	25	14
3	51	135	155	106	125	77	97	92	76	36	16

**Valid for fuses type -FU/115 & -FKE/115.

1mm = 0.0394" / 1" = 25.4mm

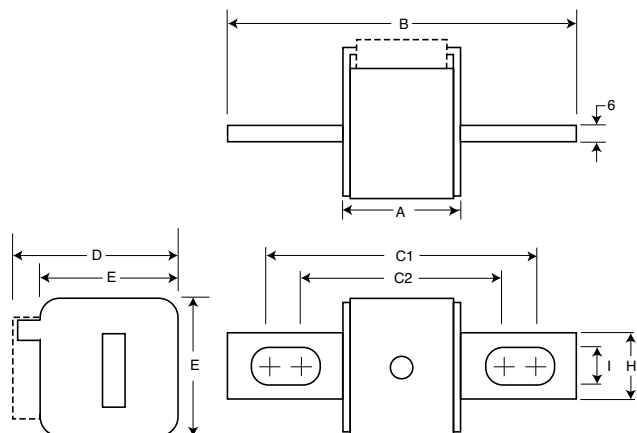

Arc Voltage

This curve gives the peak arc voltage, U_L, which may appear across the fuse during its operation as a function of the applied working voltage, E_g, (rms) at a power factor of 15%.

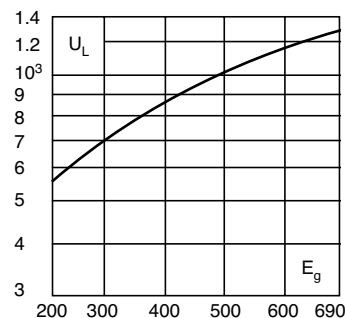

Power Losses

Watts loss at rated current is given in the electrical characteristics. The curve allows the calculation of the power losses at load currents lower than the rated current. The correction factor, K_p, is given as a function of the RMS load current, I_b, in % of the rated current.

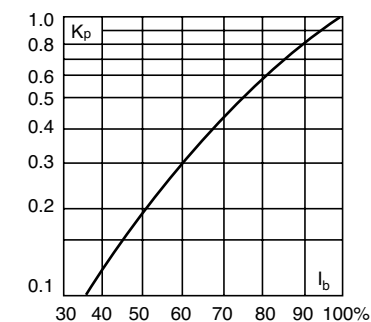

Features and Benefits

- Excellent DC performance
- Low arc voltage and low energy let-through (I²t)
- Low watts loss
- Superior cycling capability

Typical Applications

- DC Common bus
- DC Drives
- Power converters/rectifiers
- Reduced voltage starters

For Other Voltage Ratings in This Body Style

- See pages 178 (1000V) and 191 (1250V/1300V)

Square Body US style — 690V/700V (IEC): 40-2000A

Catalog Numbers

Catalog Numbers				Size	Electrical Characteristics				
-FU/ Without Indicator	-FKE/ Type K Indicator for Micro	-FU/115 Without Indicator	-FKE/115 Type K Indicator for Micro		Rated Current RMS-Amps	I ² t (A ² Sec)		Watts Loss	
						Pre-arc	Clearing at 660V		
170M3608	170M3658	170M3708	170M3758	1*	40	40	270	9	
170M3609	170M3659	170M3709	170M3759		50	77	515	11	
170M3610	170M3660	170M3710	170M3760		63	115	770	14	
170M3611	170M3661	170M3711	170M3761		80	185	1250	18	
170M3612	170M3662	170M3712	170M3762		100	360	2450	21	
170M3613	170M3663	170M3713	170M3763		125	550	3700	26	
170M3614	170M3664	170M3714	170M3764		160	1100	7500	30	
170M3615	170M3665	170M3715	170M3765		200	2200	15000	35	
170M3616	170M3666	170M3716	170M3766		250	4200	28500	40	
170M3617	170M3667	170M3717	170M3767		315	7000	46500	50	
170M3618	170M3668	170M3718	170M3768		350	10000	68500	55	
170M3619	170M3669	170M3719	170M3769		400	15000	105000	60	
170M3620	170M3670	170M3720	170M3770		450	21000	140000	65	
170M3621	170M3671	170M3721	170M3771		500	27000	180000	70	
170M3622	170M3672	170M3722	170M3772		550	34000	230000	75	
170M3623	170M3673	170M3723	170M3773		630	48500	325000	80	
170M4608	170M4658	170M4708	170M4758		1	200	1650	11500	45
170M4609	170M4659	170M4709	170M4759			250	3100	21000	55
170M4610	170M4660	170M4710	170M4760			315	6200	42000	58
170M4611	170M4661	170M4711	170M4761	350		8500	59000	60	
170M4612	170M4662	170M4712	170M4762	400		13500	91500	65	
170M4613	170M4663	170M4713	170M4763	450		17000	120000	70	
170M4614	170M4664	170M4714	170M4764	500		25000	170000	72	
170M4615	170M4665	170M4715	170M4765	550		34000	230000	75	
170M4616	170M4666	170M4716	170M4766	630		52000	350000	80	
170M4617	170M4667	170M4717	170M4767	700		69500	465000	85	
170M4618	170M4668	170M4718	170M4768	800		105000	725000	95	
170M4619	170M4669	170M4719	170M4769	±900	155000	±850000	100		
170M5608	170M5658	170M5708	170M5758	2	400	11000	74000	65	
170M5609	170M5659	170M5709	170M5759		450	15500	105000	70	
170M5610	170M5660	170M5710	170M5760		500	21500	145000	75	
170M5611	170M5661	170M5711	170M5761		550	28000	190000	80	
170M5612	170M5662	170M5712	170M5762		630	41000	275000	90	
170M5613	170M5663	170M5713	170M5763		700	60500	405000	95	
170M5614	170M5664	170M5714	170M5764		800	86000	575000	105	
170M5615	170M5665	170M5715	170M5765		900	125000	840000	110	
170M5616	170M5666	170M5716	170M5766		1000	180000	1250000	115	
170M5617	170M5667	170M5717	170M5767		1100	245000	1600000	120	
170M5618	170M5668	170M5718	170M5768		1250	365000	2400000	130	
170M6608	170M6658	170M6708	170M6758	3	500	14000	95000	95	
170M6609	170M6659	170M6709	170M6759		550	19500	135000	100	
170M6610	170M6660	170M6710	170M6760		630	31000	210000	105	
170M6611	170M6661	170M6711	170M6761		700	44500	300000	110	
170M6612	170M6662	170M6712	170M6762		800	69500	465000	115	
170M6613	170M6663	170M6713	170M6763		900	100000	670000	120	
170M6614	170M6664	170M6714	170M6764		1000	140000	945000	125	
170M6615	170M6665	170M6715	170M6765		1100	190000	1300000	130	
170M6616	170M6666	170M6716	170M6766		1250	290000	1950000	140	
170M6617	170M6667	170M6717	170M6767		1400	370000	2450000	155	
170M6618	170M6668	170M6718	170M6768		1500	460000	3100000	160	
170M6619	170M6669	170M6719	170M6769		1600	580000	3900000	160	
170M6620	170M6670	170M6720	170M6770		†1800	880000	†5250000	165	
170M6621	170M6671	170M6721	170M6771		±2000	1150000	±6350000	175	

†Rated voltage (IEC) 600V.

‡Rated voltage (IEC) 550V.

• Watts loss provided at rated current.

• Microswitch indicator ordered separately. See accessories on pages 212-213.

• For fuse curves see pages 158 and 159.

High Speed Fuses

Square Body French Style — 690V/700V (IEC/UL): 40-1500A

690V/700V (IEC/UL) 40-1500A

Specifications

Description: Square body French style high speed fuses.

Dimensions: See dimensions illustration.

Ratings:

Volts: — 690Vac (IEC)
— 700Vac (UL)

Amps: — 40-1500A

IR: — 200kA RMS Sym.

Agency Information: CE, Designed and tested to IEC 60269: Part 4. UL Recognized E125085.JFHR2 & CSA Component Acceptance file Class 1422-30, (53787) on Sizes (1, 2, 3) only

Electrical Characteristics

Total Clearing I²t

The total clearing I²t at rated voltage and at power factor of 15% are given in the electrical characteristics. For other voltages, the clearing I²t is found by multiplying by correction factor, K, given as a function of applied working voltage, E_g, (rms).

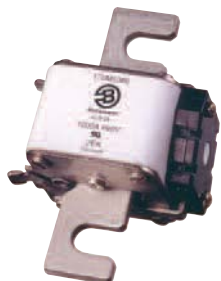
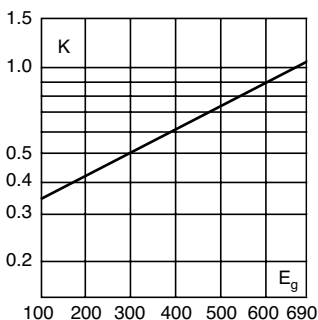

Arc Voltage

This curve gives the peak arc voltage, U_L, which may appear across the fuse during its operation as a function of the applied working voltage, E_g, (rms) at a power factor of 15%.

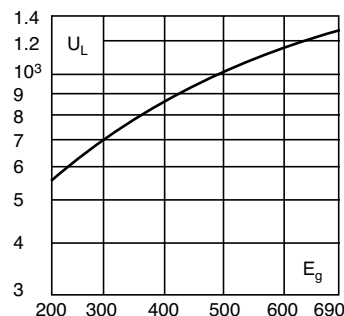

Power Losses

Watts loss at rated current is given in the electrical characteristics. The curve allows the calculation of the power losses at load currents lower than the rated current. The correction factor, K_p, is given as a function of the RMS load current, I_b, in % of the rated current.

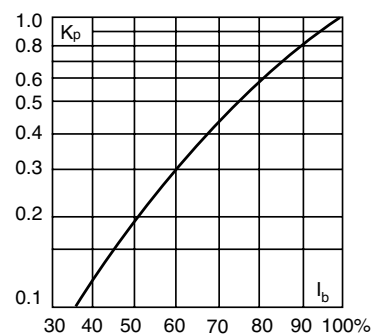

Features and Benefits

- Excellent DC performance
- Low arc voltage and low energy let-through (I²t)
- Low watts loss
- Superior cycling capability

Typical Applications

- DC Common bus
- DC Drives
- Power converters/rectifiers
- Reduced voltage starters

Dimensions - mm

Type -E/-, -EKN/-

Size	A	B	C	D	E	H	I	J
1*	50	102	76	59	45	18	9	13
1	50	111	86	69	53	25	11	11
2	50	126	91	77	61	30	13	12
3	51	126	91	92	76	36	13	13

1mm = 0.0394" / 1" = 25.4mm

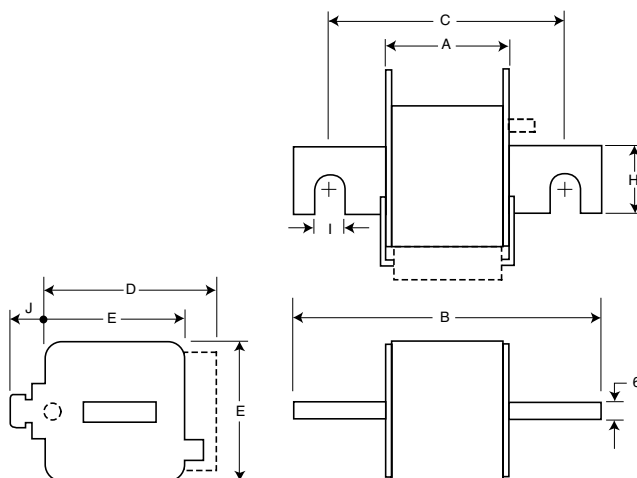

Square Body French Style — 690V/700V (IEC/UL): 40-1500A

Catalog Numbers

Catalog Numbers		Size	Electrical Characteristics			
-E/ Type T Indicator For Micro	-EKN/ Type K Indicator for Micro		Rated Current RMS-Amps	I2t (A2 Sec)		Watts Loss
				Pre-arc	Clearing at 660V	
170M3308	170M3358	1*	40	40	270	9
170M3309	170M3359		50	77	515	11
170M3310	170M3360		63	115	770	14
170M3311	170M3361		80	185	1250	18
170M3312	170M3362		100	360	2450	21
170M3313	170M3363		125	550	3700	26
170M3314	170M3364		160	1100	7500	30
170M3315	170M3365		200	2200	15000	35
170M3316	170M3366		250	4200	28500	40
170M3317	170M3367		315	7000	46500	50
170M3318	170M3368		350	10000	68500	55
170M3319	170M3369		400	15000	105000	60
170M3320	170M3370		450	21000	140000	65
170M3321	170M3371		500	27000	180000	70
170M4308	170M4358		1	200	1650	11500
170M4309	170M4359	250		3100	21000	55
170M4310	170M4360	315		6200	42000	58
170M4311	170M4361	350		8500	59000	60
170M4312	170M4362	400		13500	91500	65
170M4313	170M4363	450		17000	120000	70
170M4314	170M4364	500		25000	170000	72
170M4315	170M4365	550		34000	230000	75
170M4316	170M4366	630		52000	350000	80
170M4317	170M4367	700		69500	465000	85
170M4318	170M4368	800	105000	725000	95	
170M5308	170M5358	2	400	11000	74000	65
170M5309	170M5359		450	15500	105000	70
170M5310	170M5360		500	21500	145000	75
170M5311	170M5361		550	28000	190000	80
170M5312	170M5362		630	41000	275000	90
170M5313	170M5363		700	60500	405000	95
170M5314	170M5364		800	86000	575000	105
170M5315	170M5365		900	125000	840000	110
170M5316	170M5366	1000	180000	1250000	115	
170M6308	170M6358	3	500	14000	95000	95
170M6309	170M6359		550	19500	135000	100
170M6310	170M6360		630	31000	210000	105
170M6311	170M6361		700	44500	300000	110
170M6312	170M6362		800	69500	465000	115
170M6313	170M6363		900	100000	670000	120
170M6314	170M6364		1000	140000	945000	125
170M6315	170M6365		1100	190000	1300000	130
170M6316	170M6366		1250	290000	1950000	140
170M6317	170M6367		1400	370000	2450000	155
170M6318	170M6368	1500	460000	3100000	160	

- Watts loss provided at rated current.
- Microswitch indicator ordered separately. See accessories on pages 212-213.
- For fuse curves see pages 158 and 159.

Square Body, French Style - Size 1*, 1 — 690V/700V (IEC/UL): 40-2000A

Size 1* — 40-630A: 690V
Time-Current Curve

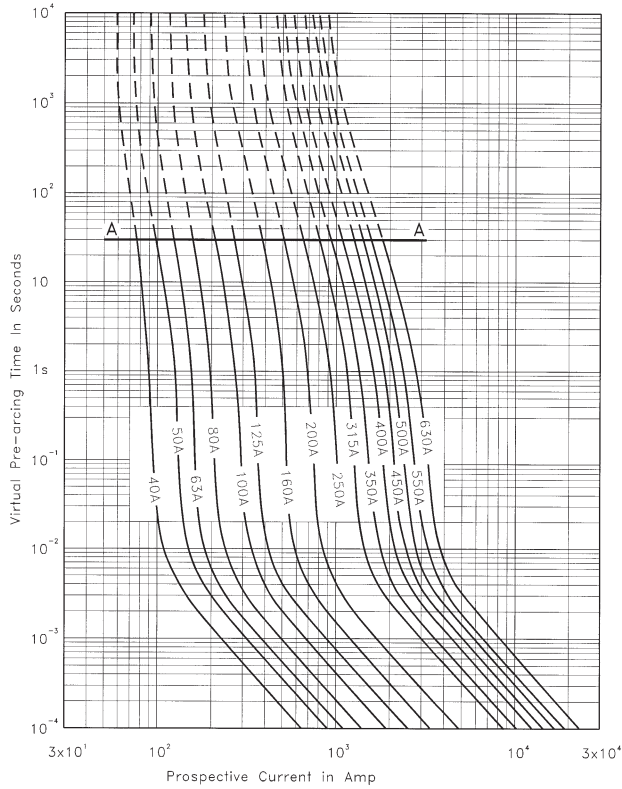

Size 1 — 200-900A: 690V
Time-Current Curve

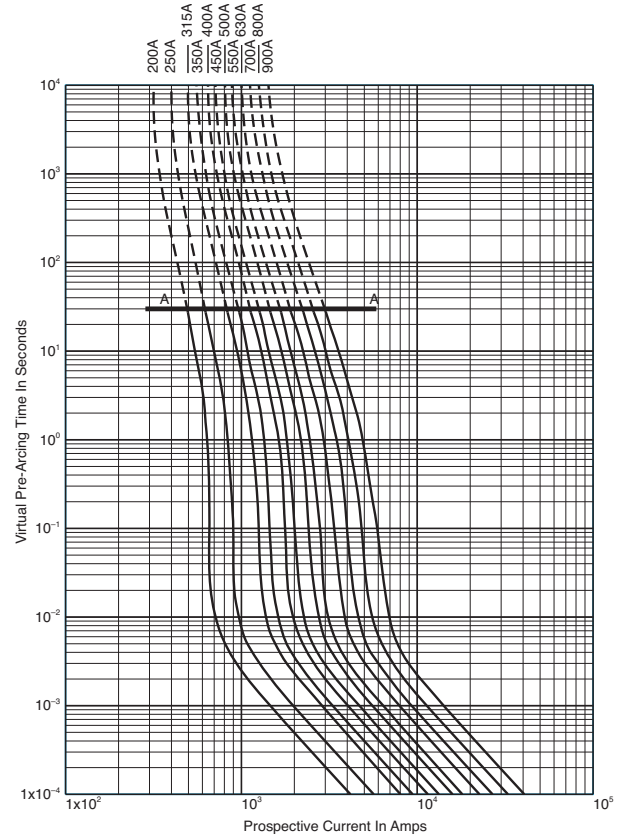

Peak Let-Through Curve

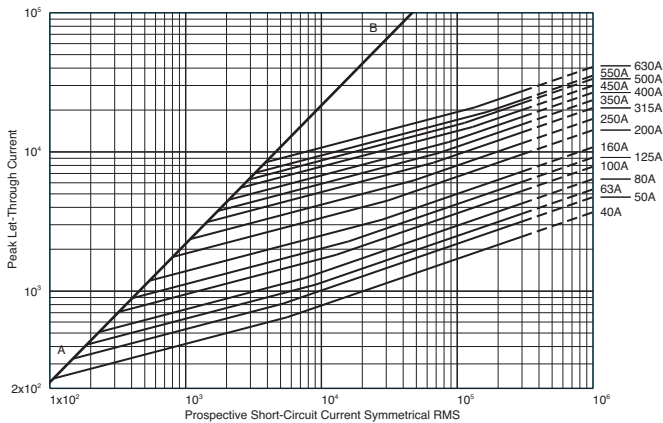

Peak Let-Through Curve

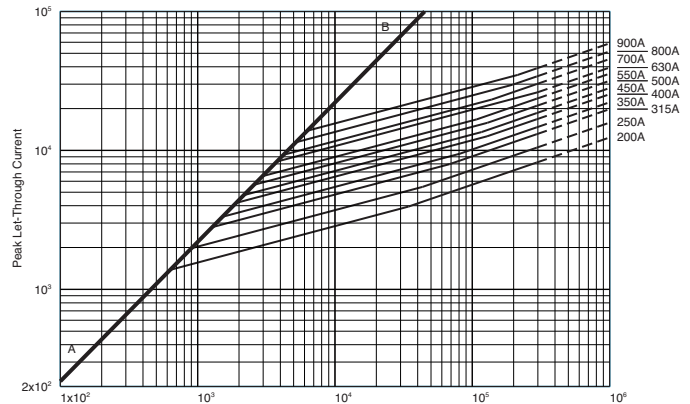

900 amp fuse is derated to 550V (IEC).

Square Body, French Style - Size 2, 3 — 690V/700V (IEC/UL): 40-2000A

Size 2 — 400-1250A: 690V
Time-Current Curve

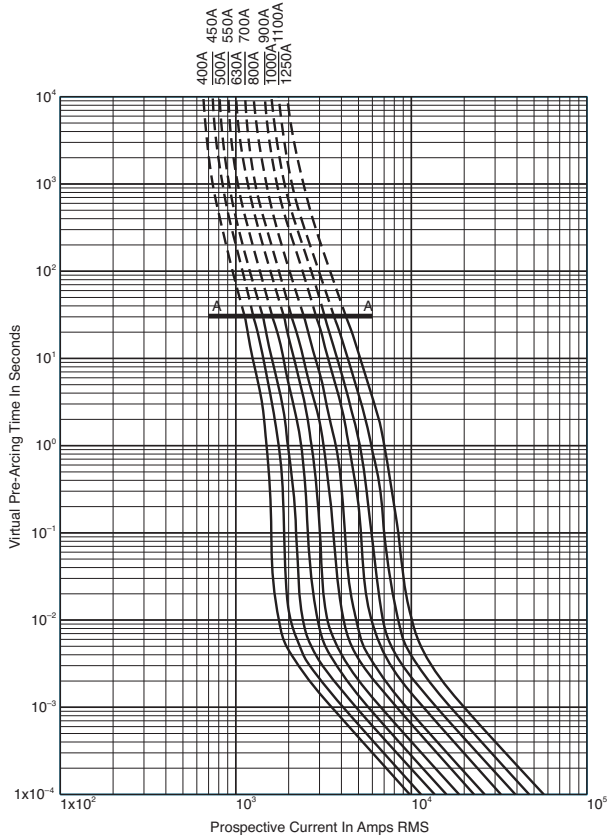

Size 3 — 500-2000A: 690V
Time-Current Curve

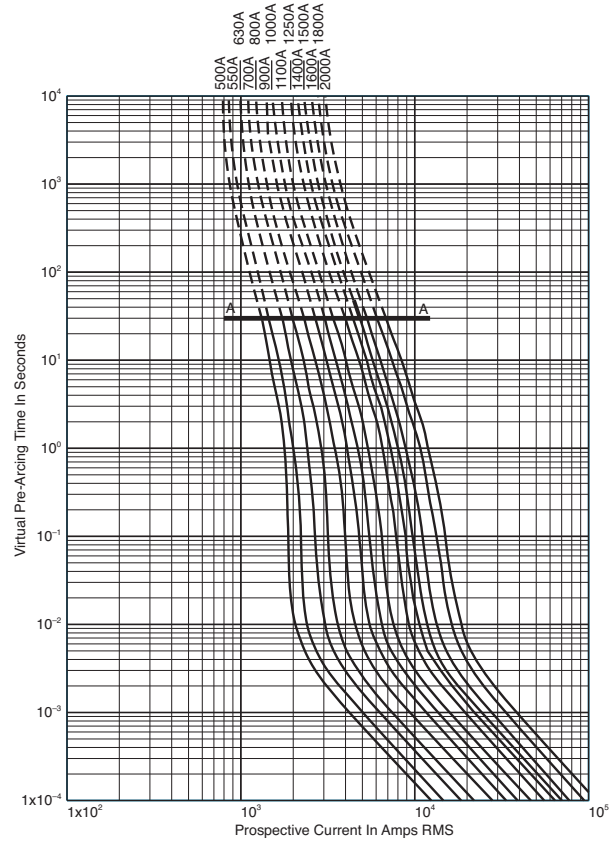

Peak Let-Through Curve

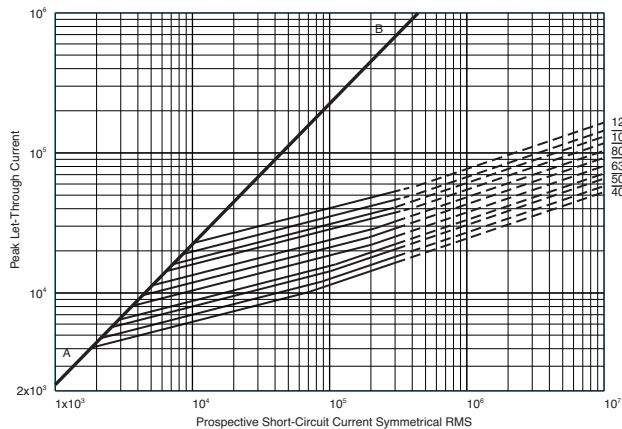

Peak Let-Through Curve

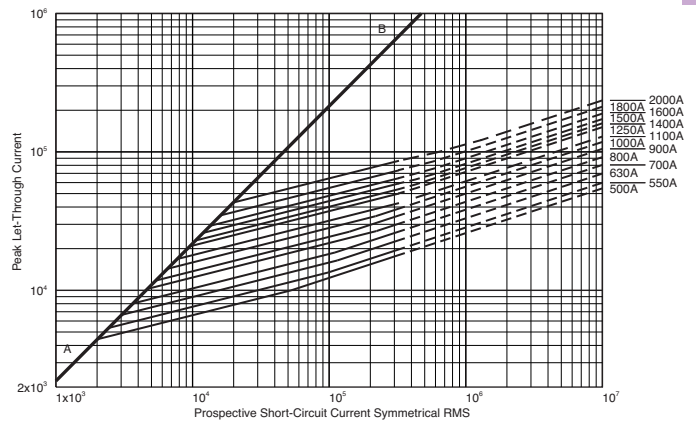

1800A fuse is derated to 600V (IEC).
2000A fuse is derated to 550V (IEC).

Square Body DIN 43 620 — 690V/700V (IEC/UL): 40-1000A

690V/700V (IEC/UL) 40-1000A

Specifications

Description: Square body DIN 43 620 blade style high speed fuses.

Dimensions: See dimensions illustration.

Ratings:

Volts: — 690Vac (IEC)
— 700Vac (UL)

Amps: — 40-1000A

IR: — 200kA RMS Sym.

Agency Information: CE, Designed and tested to IEC 60269: Part 4. UL Recognized E125085.JFHR2.

Electrical Characteristics

Total Clearing I²t

The total clearing I²t at rated voltage and at power factor of 15% are given in the electrical characteristics. For other voltages, the clearing I²t is found by multiplying by correction factor, K, given as a function of applied working voltage, E_g, (rms).

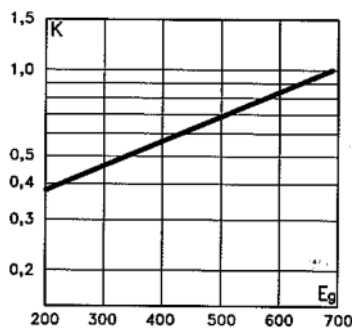

Arc Voltage

This curve gives the peak arc voltage, U_L, which may appear across the fuse during its operation as a function of the applied working voltage, E_g, (rms) at a power factor of 15%.

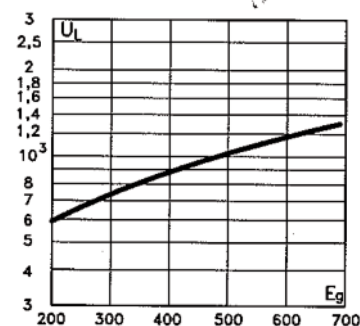

Power Losses

Watts loss at rated current is given in the electrical characteristics. The curve allows the calculation of the power losses at load currents lower than the rated current. The correction factor, K_p, is given as a function of the RMS load current, I_b, in % of the rated current.

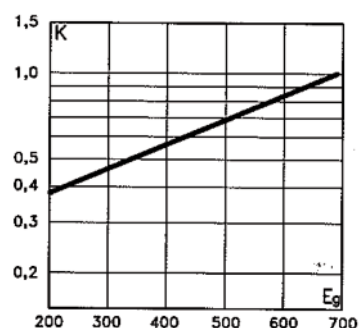

Features and Benefits

- Excellent DC performance
- Low arc voltage and low energy let-through (I²t)
- Low watts loss
- Superior cycling capability

Typical Applications

- DC Common bus
- DC Drives
- Power converters/rectifiers
- Reduced voltage starters

For Full Range Fuses in This Body Style

- See page 168

Dimensions (mm)

Type DIN 1*, DIN 2, DIN 3

Size	A	B	D	E	F	H
1*	69	135	58	45	40	20
2	69	150	71	55	48	26
3	68	150	88	76	60	33

1mm = 0.0394" / 1" = 25.4mm

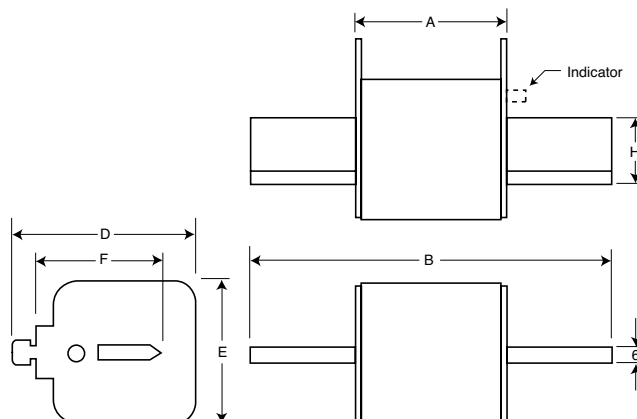

Square Body DIN 43 620 — 690V/700V (IEC/UL): 40-600A

Catalog Numbers

Catalog Numbers DIN Type T Indicator for Micro	Size	Electrical Characteristics			
		Rated Current RMS-Amps	I ² t (A ² Sec)		Watts Loss
			Pre-arc	Clearing at 660V	
170M3808D	1*	40	40	285	4
170M3809D		50	78	550	4.5
170M3810D		63	120	850	6.5
170M3811D		80	185	1350	8.5
170M3812D		100	360	2600	10
170M3813D		125	550	3900	11
170M3814D		160	1150	8250	12
170M3815D		200	2300	16500	12.5
170M3816D		250	4350	31000	16
170M3817D		315	7300	52000	20
170M3818D		350	10000	73000	21.5
170M3819D		400	16000	115000	60
170M4863D		450	21500	155000	26.3
170M4864D		500	27000	190000	28.5
170M4865D		550	33500	240000	33
170M4866D		630	48500	345000	37.5
170M4867D		700	69500	495000	39
170M5808D	2	400	11000	79000	29
170M5809D		450	16000	115000	32
170M5810D		500	21500	155000	34
170M5811D		550	29000	215000	36
170M5812D		630	41000	295000	42
170M5813D		700	60500	430000	43
170M5814D		800	86000	610000	48
170M5820D		900	125000	895000	52
170M5816D		1000	180000	1300000	53
170M5817D		1100	245000	1750000	56
170M6808D	3	500	14000	99500	43
170M6809D		550	19500	140000	44
170M6810D		630	31000	220000	45
170M6811D		700	45000	320000	46
170M6812D		800	69500	490000	48
170M6813D		900	100000	720000	50
170M6814D		1000	140000	985000	56
170M6892D		1100	190000	1400000	57
170M8554D		1250	300000	2150000	61
170M8555D		1400	380000	2700000	70
170M8556D	1500	470000	3350000	72	
170M8557D	1600	585000	4150000	74	

- Watts loss provided at rated current.
- Microswitch indicator ordered separately. See accessories on pages 212-213.
- For fuse curves see page 162.

Rated Current

The rated current of this fuse range has been given with copper conductors that have a current density of 1.3A/mm² (IEC 60269-4). For conductor cross section according to IEC 60269-1, the fuses must be derated. Please contact Bussmann for application assistance.

Size 1* — 40-630A: 690V Time-Current Curve

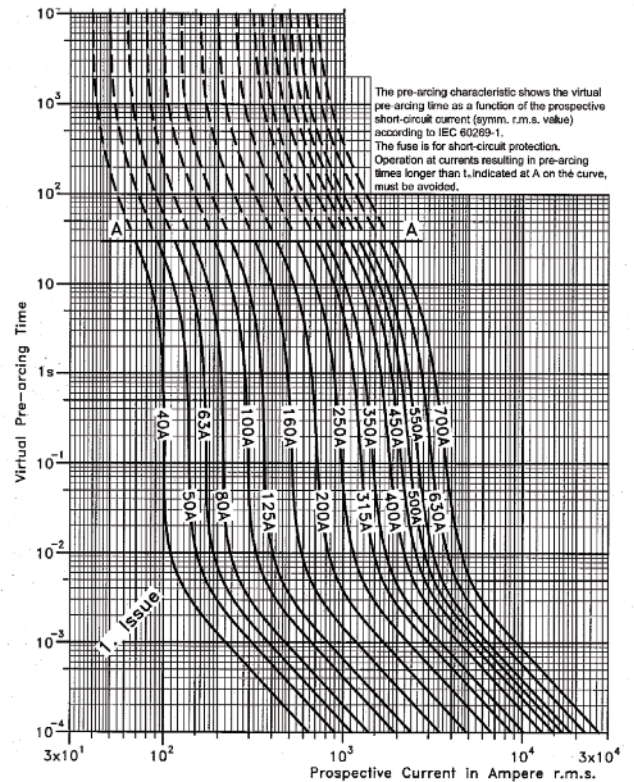

Peak Let-Through Curve

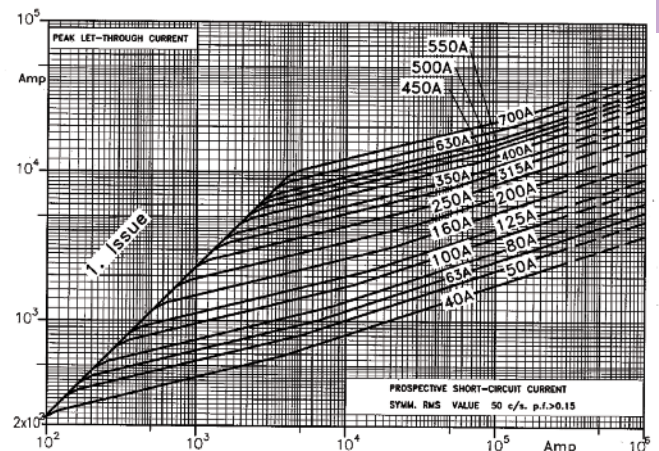

Data Sheet: 17056314

Square Body DIN 43 620 — 690V/700V (IEC/UL): 40-1000A

Size 2 — 400-1250A: 690V
Time-Current Curve

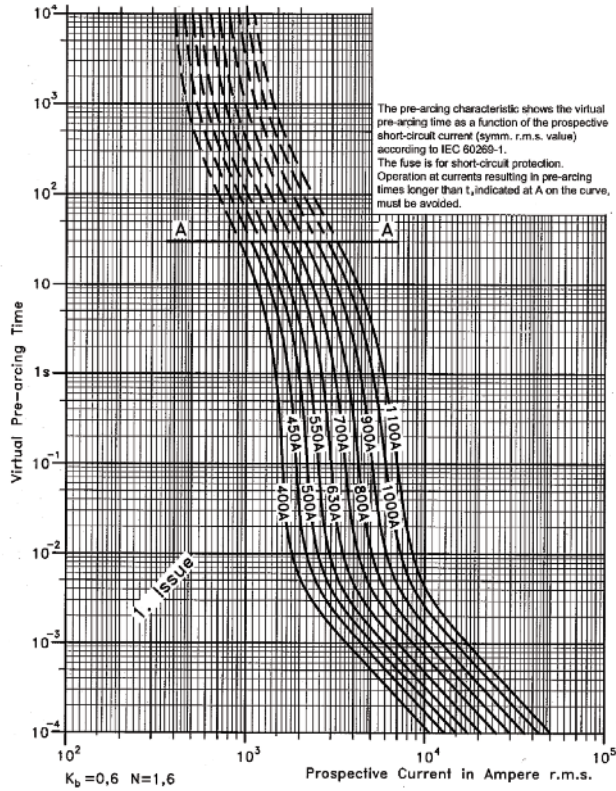

Size 3 — 500-2000A: 690V
Time-Current Curve

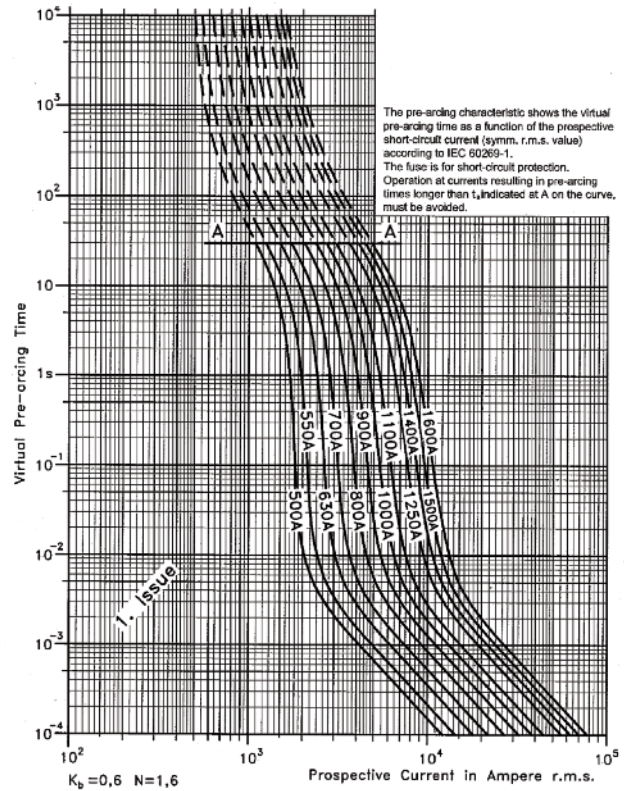

Peak Let-Through Curve

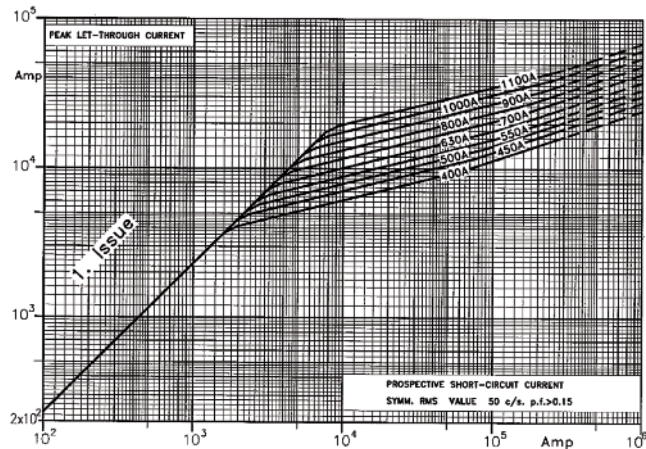

Peak Let-Through Curve

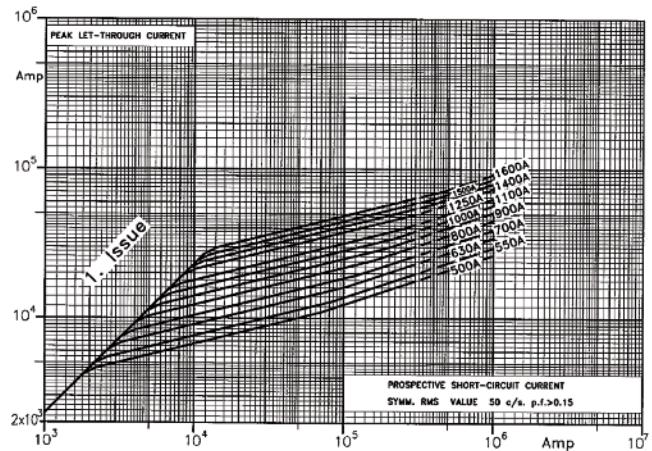

Square Body Flush End Contact — 690/700V (IEC/UL): 1000-4000A

690V (IEC) 1000-4000A

Specifications

Description: Square body flush end contact high speed fuses.

Dimensions: See dimensions illustrations.

Ratings:

- Volts: — 690Vac
- Amps: — 1000-4000A
- IR: — 200kA RMS Sym.

Agency Information: CE, Designed and tested to IEC 60269: Part 4. UL Recognized E125085.JFHR2.

Electrical Characteristics

Total Clearing I²t

The total clearing I²t at rated voltage and at power factor of 15% are given in the electrical characteristics. For other voltages, the clearing I²t is found by multiplying by correction factor, K, given as a function of applied working voltage, E_g, (rms).

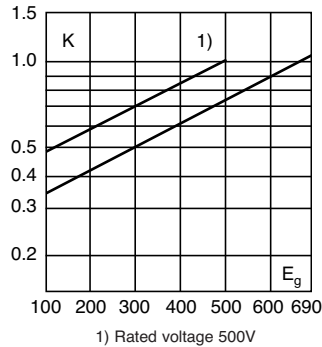

Dimensions - mm

Type 4B/-, 4BKN/-, 4G/-, 4GKN/-

Size	F (in)	G
4B	M10 10 deep	33
4G	½" -13 UNC-2B 10 deep	38

1mm = 0.0394" / 1" = 25.4mm

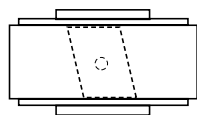
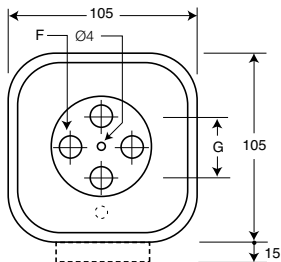

Arc Voltage

This curve gives the peak arc voltage, U_L, which may appear across the fuse during its operation as a function of the applied working voltage, E_g, (rms) at a power factor of 15%.

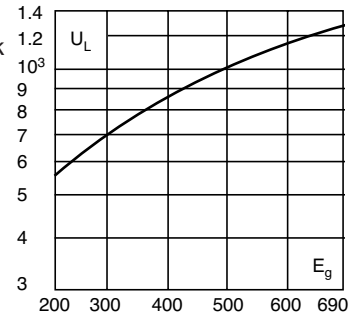

Power Losses

Watts loss at rated current is given in the electrical characteristics. The curve allows the calculation of the power losses at load currents lower than the rated current. The correction factor, K_p, is given as a function of the RMS load current, I_b, in % of the rated current.

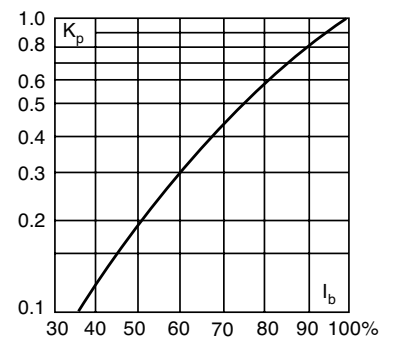

Features and Benefits

- Excellent DC performance
- Low arc voltage and low energy let-through (I²t)
- Low watts loss
- Superior cycling capability

Typical Applications

- DC Common bus
- DC Drives
- Power converters/rectifiers
- Reduced voltage starters

For Other Voltage Ratings in This Body Style

- See pages 182 (1000V) and 195 (1250V)

Square Body Flush End Contact — 690V (IEC): 1000-4000A

Catalog Numbers

Catalog Numbers				Size	Electrical Characteristics					
-B/- Visual Indicator	-BKN/- Type K Indicator for Micro	-G/- Visual Indicator	-GKN/- Type K Indicator for Micro		Rated Current RMS		I ² t (A ² Sec)		Watts Loss	
					Norm. Cool.	Liquid Cool.	Pre-arc	Clearing at 660V	Norm. Cool.	Liquid Cool.
170M7058	170M7078	170M7098	170M7118	4	1000	1350	76000	505000	175	315
170M7059	170M7079	170M7099	170M7119		1250	1700	145000	965000	195	355
170M7060	170M7080	170M7100	170M7120		1400	1900	205000	1400000	205	375
170M7061	170M7081	170M7101	170M7121		1600	2200	305000	2050000	220	405
170M7062	170M7082	170M7102	170M7122		2000	2700	600000	3950000	245	445
170M7063	170M7083	170M7103	170M7123		2500	3400	1200000	7800000	275	495
170M7064	170M7084	170M7104	170M7124		3000	4100	2000000	13500000	305	555
170M7065	170M7085	170M7105	170M7125		3500	4700	3250000	22000000	325	585
170M7066	170M7086	170M7106	170M7126		†4000	†5400	4700000	†28000000	355	640

†Rated voltage (IEC) 500V.

• Watts loss provided at rated current.

• Liquid Cool. = Liquid cooling. Temperature on the terminals not to exceed 60°C.

• Microswitch indicator ordered separately. See accessories on pages 212-213.

Size 4 — 1000-4000A: 690V

Time-Current Curve

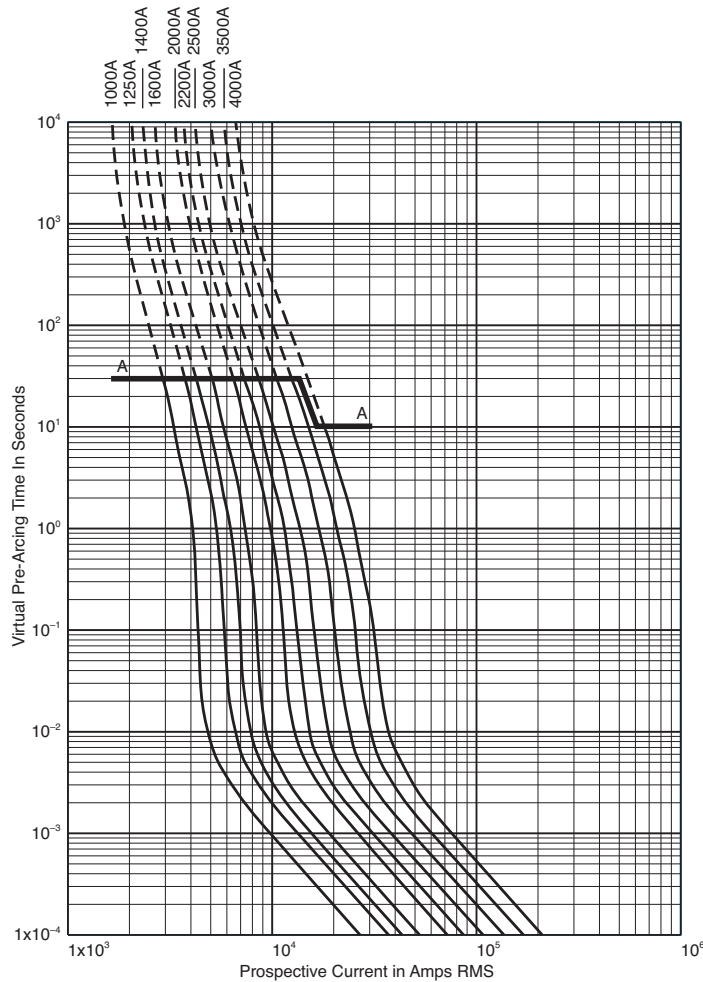

Peak Let-Through Curve

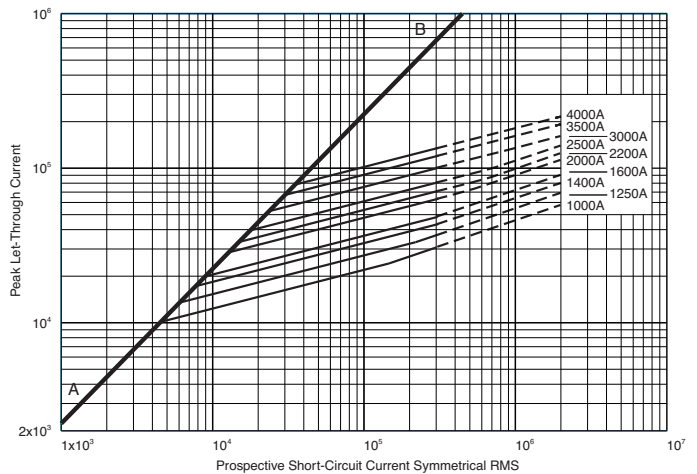

4000A fuse is derated to 500V (IEC).

Data Sheet: 17056328

Square Body Flush End Contact Size 23, 24 — 660V (IEC): 1000-7500A

660V (IEC) 1000-7500A

Specifications

Description: High speed square body fuses, for the protection of the power rectifier section of the equipment.

Dimensions: See dimensions illustrations.

Ratings:

Volts: — 660Vac

Amps: — 1000-4000A

IR: — 300kA RMS Sym.

Agency Information: CE, Designed and tested to IEC 60269: Part 4. UL Recognized E125085.JFHR2.



Electrical Characteristics

Total clearing I^2t

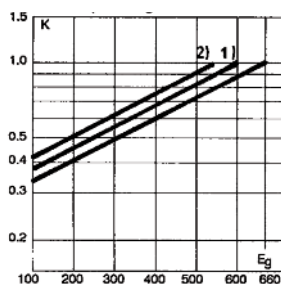

Size 23

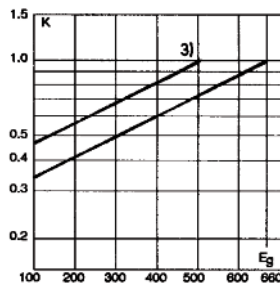

Size 24

The total clearing I^2t at rated voltage and at power factor of 15% are given in the electrical characteristics. For other voltages, the clearing I^2t is found by multiplying by correction factor, K, given as a function of applied working voltage, E_g , (rms).

Features and Benefits

- Low watts loss
- Superior cycling capability

Typical Applications

- Power converters/rectifiers
- Reduced voltage starters

Arc Voltage

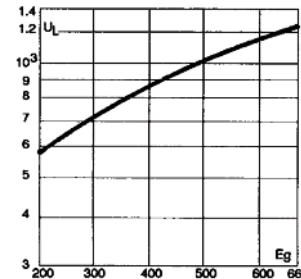

Size 23

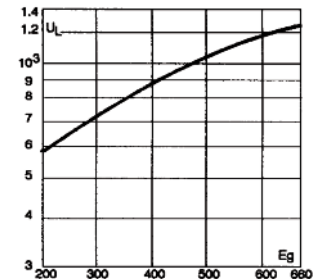

Size 24

This curve gives the peak arc voltage, U_L , which may appear across the fuse during its operation as a function of the applied working voltage E_g , (rms) at a power factor of 15%.

Power Losses

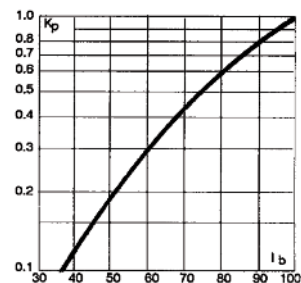

Size 23

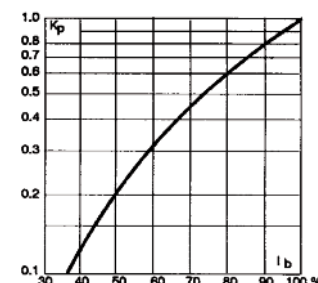

Size 24

Watts loss at rated current is given in the electrical characteristics. The curve allows the calculation of the power losses at load currents lower than the rated current. The correction factor, K_p , is given as a function of the RMS load current, I_b , in % of the rated current.

For Other Voltage Ratings in This Body Style

- See pages 185 (1000V) and 198 (1250V)

Square Body Flush End Contact Size 23, 24 — 660V (IEC): 1000-7500A

Fuse Size	Catalogue Number						Electrical Characteristics					
	-BU/55 Visual Indicator	-BKE/55 Type K Indicator	-BKN/55 Type K Indicator	-GU/55 Visual Indicator	-GKE/55 Type K Indicator	-GKN/55 Type K Indicator	Rated Voltage (V)	Rated Current RMS-Amp	I ² t (A ² Sec)		Watt Loss (W)	
	Pre-arc	Clearing at 660V										
23	170M6858	170M6898	170M6878	170M6918	170M6958	170M6938	660	1000	79,000	530,000	170.0	
	170M6859	170M6899	170M6879	170M6919	170M6959	170M6939		1100	95,000	635,000	185.0	
	170M6860	170M6900	170M6880	170M6920	170M6960	170M6940		1250	155,000	1,050,000	190.0	
	170M6861	170M6901	170M6881	170M6921	170M6961	170M6941		1400	200,000	1,350,000	210.0	
	170M6862	170M6902	170M6882	170M6922	170M6962	170M6942		1500	240,000	1,650,000	215.0	
	170M6863	170M6903	170M6883	170M6923	170M6963	170M6943		1600	315,000	2,150,000	220.0	
	170M6864	170M6904	170M6884	170M6924	170M6964	170M6944		1800	450,000	3,050,000	230.0	
	170M6865	170M6905	170M6885	170M6925	170M6965	170M6945		2000	625,000	4,200,000	240.0	
	170M6866	170M6906	170M6886	170M6926	170M6966	170M6946		2200	805,000	5,400,000	255.0	
	170M6867	170M6907	170M6887	170M6927	170M6967	170M6947		2500	1,250,000	8,350,000	265.0	
	170M6868	170M6908	170M6888	170M6928	170M6968	170M6948		3000	2,250,000	15,500,000	285.0	
	170M6869	170M6909	170M6889	170M6929	170M6969	170M6949		600	3500	3,450,000	21,000,000	315.0
	170M6870	170M6910	170M6890	170M6930	170M6970	170M6950		550	4000	5,000,000	27,500,000	340.0

Data Sheet: 170K6326

Catalog Numbers:

Fuse Size	Catalogue Number				Electrical Characteristics					
	-BU/60 without Indicator	-BKN/60 Type K Indicator	-GU/60 without Indicator	-GKN/60 Type K Indicator	Rated Voltage (V)	Rated Current RMS-Amp	I ² t (A ² Sec)		Watts Loss (W)	
	Pre-arc	Clearing at 660V								
24	170M7138	170M7158	170M7198	170M7218	690	2000	340000	2300000	340	
	170M7139	170M7159	170M7199	170M7219		2500	650000	4350000	390	
	170M7140	170M7160	170M7200	170M7220		3000	1100000	7300000	430	
	170M7141	170M7161	170M7201	170M7221		3500	1800000	12000000	460	
	170M7142	170M7162	170M7202	170M7222		4000	2700000	18000000	490	
	170M7143	170M7163	170M7203	170M7223		4500	3800000	25500000	520	
	170M7144	170M7164	170M7204	170M7224		5000	5450000	36500000	540	
	170M7145	170M7165	170M7205	170M7225		5500	7400000	49500000	560	
	170M7146	170M7166	170M7206	170M7226		6000	9600000	64000000	580	
	170M7147	170M7167	170M7207	170M7227		6500	12500000	83000000	600	
	170M7148	170M7168	170M7208	170M7228		7000	15000000	100000000	630	
	170M7149	170M7169	170M7209	170M7229		500	7500	18500000	†93000000	660

† A's @ 500V
Data Sheet: 170K6332

Dimensions - mm

Size 23

Type - BU 55, -BKE/55, -BKN 55, -GU/55, -GKE/55, -GKN 55

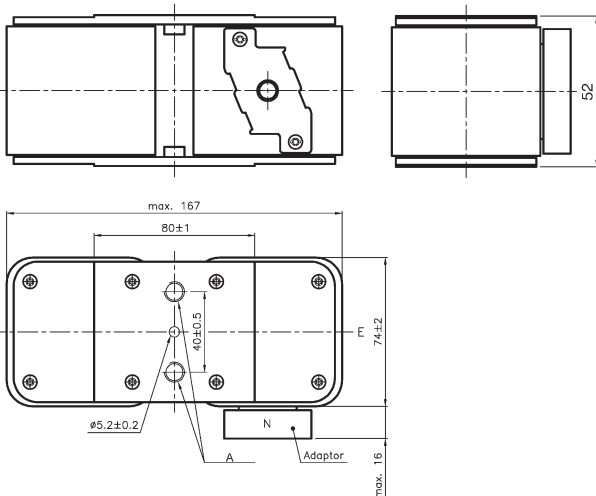

Size 24

Type - BU 55, -BKE/55, -BKN 55, -GU/55, -GKE/55, -GKN 55

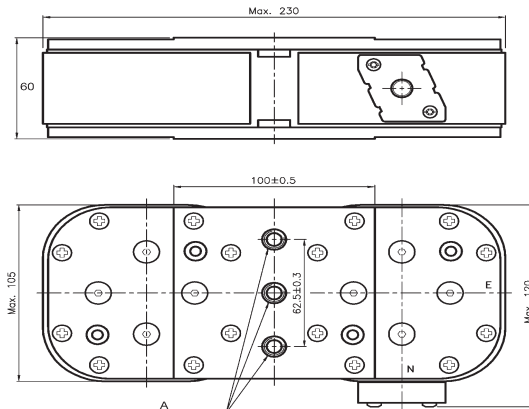

Size	A
24BKN	2x3 M12
24GKN	2x3 1/2" 16UNC-2B

Square Body Flush End Contact Size 23, 24 — 660V (IEC): 1000-7500A

Size 23 — 10000-4000A: 660V
Time-Current Curve

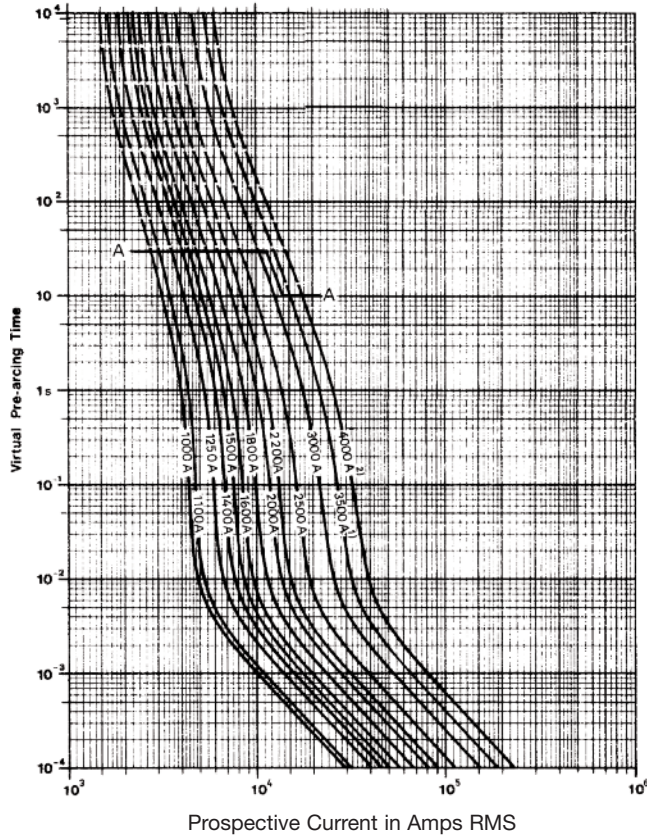

Size 24 — 2000-7500A: 660V
Time-Current Curve

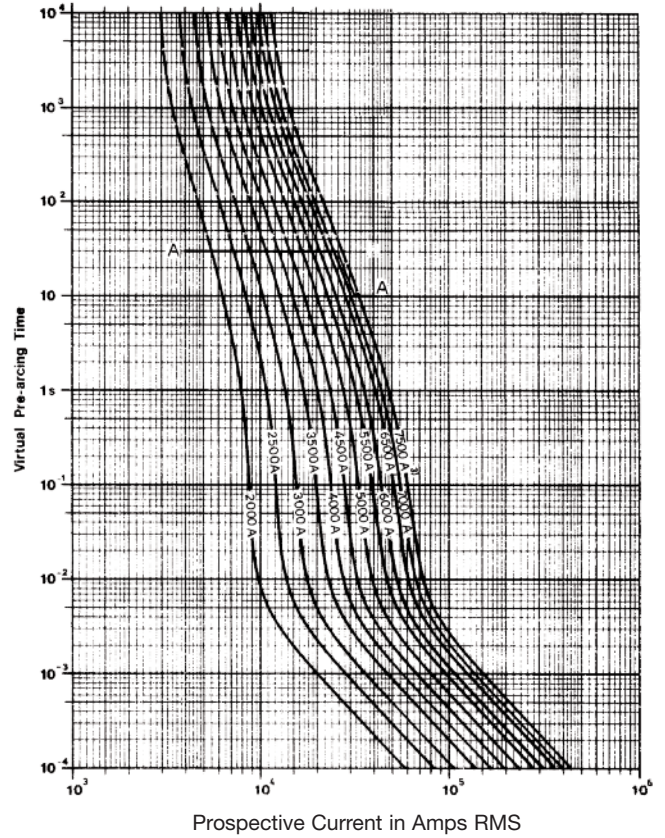

Peak Let-Through Curve

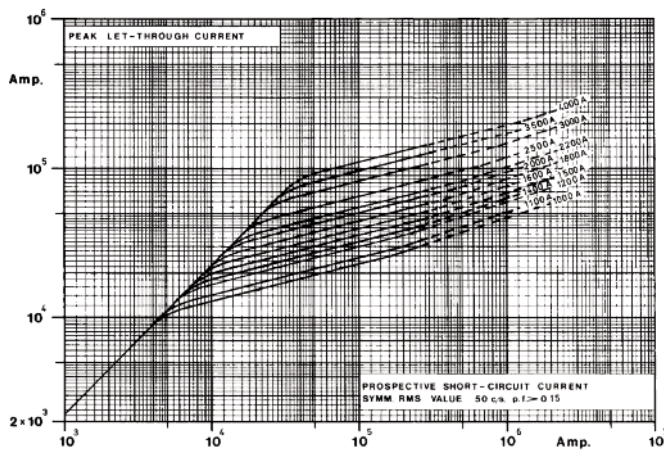

Peak Let-Through Curve

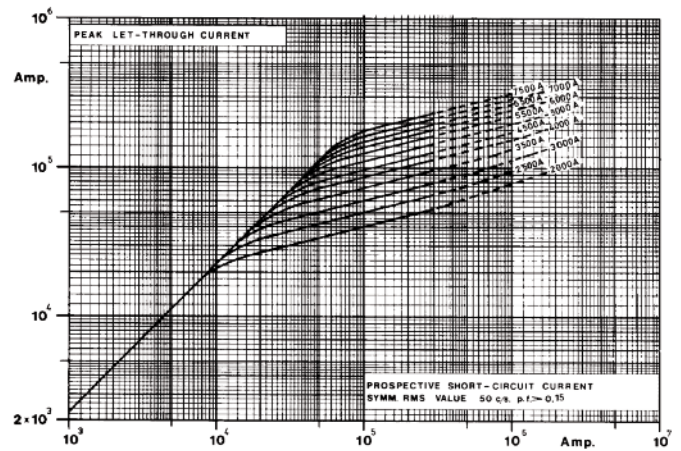

Data Sheet: Available upon request

Data Sheet: Available upon request

Square Body DIN 43 620 — 690V (IEC): 10-800A Class gR — Full Range Fuses

690V (IEC) 10-800A

Specifications

Description: Square body DIN 43 620 blade style high speed fuses.

Dimensions: See dimensions illustration.

Ratings:

Volts: — 690Vac (IEC)

Amps: — 10-800A

IR: — 300kA RMS Sym.

Agency Information: CE, Designed and tested to IEC 60269: Part 4. UL Recognized E125085.JFHR2.

Electrical

Characteristics

Total clearing I²t

The total clearing I²t at rated voltage and at power factor of 15% are given in the electrical characteristics. For other voltages, the clearing I²t is found by multiplying by correction factor, K, given as a function of applied working voltage, E_g, (rms).

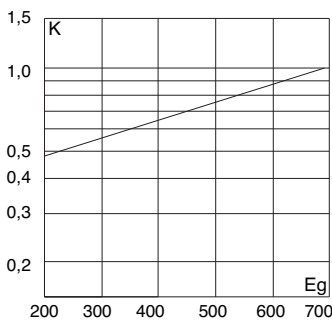

Arc Voltage

This curve gives the peak arc voltage, U_L, which may appear across the fuse during its operation as a function of the applied working voltage E_g, (rms) at a power factor of 15%.

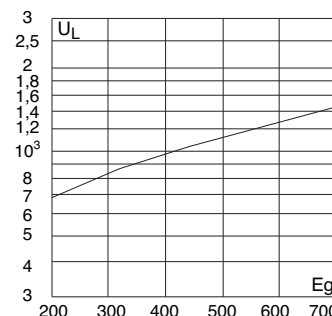

Power Losses

Watts loss at rated current is given in the electrical characteristics. The curve allows the calculation of the power losses at load currents lower than the rated current. The correction factor, K_p, is given as a function of the RMS load current, I_b, in % of the rated current.

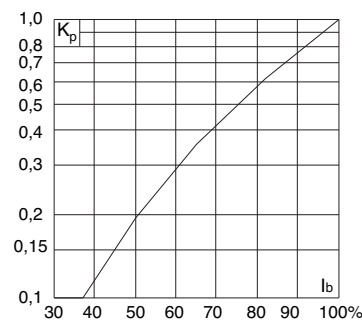

Features and Benefits

- Excellent DC performance
- Low arc voltage and low energy let-through (I²t)
- Low watts loss
- Superior cycling capability

Typical Applications

- DC Common bus
- DC Drives
- Power converters/rectifiers
- Reduced voltage starters

For Operating Class aR Fuses in This Body Style

- See page 160

Dimensions - mm

Type DIN 00, DIN 1, DIN 2, DIN 3

Size	A	B Max	D Max	E	F Min	H
00	49	78.5	60	30	35	15
1	68	135	66	52	40	20
2	68	150	74	60	48	25
3	68	150	89	75	60	32

1 mm = 0.0394" 1" = 25.4 mm

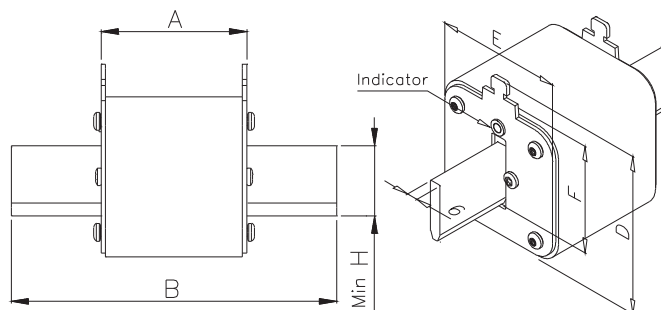

Square Body DIN 43 620 — 690V (IEC): 10-800A Class gR — Full Range Fuses

Catalog Numbers

Catalog Numbers Type T Indicator For Micro	Size	Electrical Characteristics			
		RMS Amp Rating*	I ² t (A ² Sec)		Watts Loss
			Pre-arc	Clearing at 600V	
170M2691	00	10	3.8	20	3.5
170M2692		16	7.2	38	5.5
170M2693		20	13	70	6
170M2694		25	24	125	8
170M2695		32	53	275	9
170M2696		40	95	490	10
170M2697		50	185	1000	11
170M2698		63	345	1800	14
170M2699		80	695	3600	16
170M2700		100	1250	6650	19
170M2701		125	2300	12000	23
170M2702		160	4350	22500	29
170M4176		1	50	135	705
170M4177	63		245	1300	15
170M4178	80		500	2600	17
170M4179	100		950	4850	20
170M4180	125		1850	9500	23
170M4181	160		3450	18000	28
170M4182	200		6750	34500	31
170M4183	250		13500	70500	35
170M4184	315		26000	135000	41
170M4185	350		34000	175000	45
170M4186	400		48500	250000	48
170M5881	2	200	5650	29000	33
170M5882		250	10000	52500	40
170M5883		315	19500	105000	46
170M5884		350	26000	135000	50
170M5885		400	39500	205000	53
170M5886		450	55500	290000	59
170M5887		500	73000	375000	66
170M5888		550	100000	515000	70
170M5889		630	150000	770000	79
170M6080	3	350	23000	120000	55
170M6081		400	34000	175000	59
170M6082		450	48500	250000	62
170M6083		500	64000	330000	67
170M6084		550	84500	435000	70
170M6085		630	125000	645000	85
170M6086		700	160000	840000	93
170M6087		800	245000	1300000	99

*The RMS amp rating of this fuse range is given with open fuse bases connected to copper conductors according to IEC 60269, Part 1, table 10. When used in enclosed fuse bases/disconnects, derating factors have to be observed.

Please contact Bussmann for application assistance.

- Watts loss provided at rated current.
- Microswitch ordered separately. See accessories on page 212-213.
- For fuse curves see pages 170 and 171.

High Speed Fuses

Square Body, DIN 43 620 - Size 00, 1 — 690V (IEC): 10-800A Class gR — Full Range Fuses

Size 00 — 10-160A: 690V
Time-Current Curve

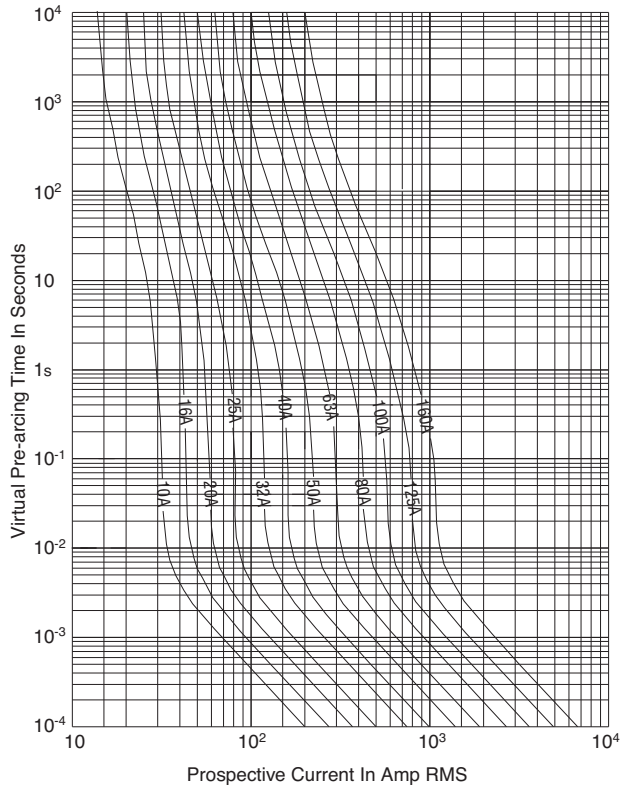

Size 1 — 50-400A: 690V
Time-Current Curve

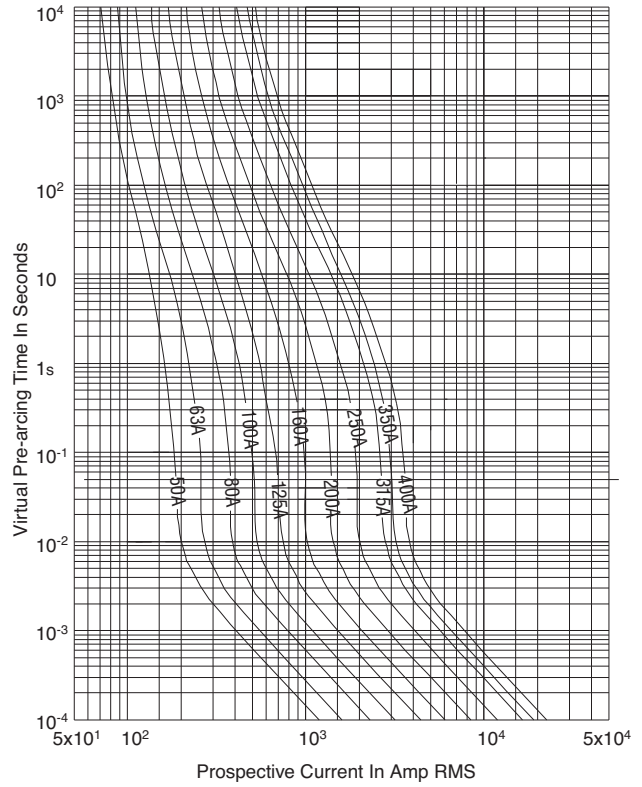

Peak Let-Through Curve

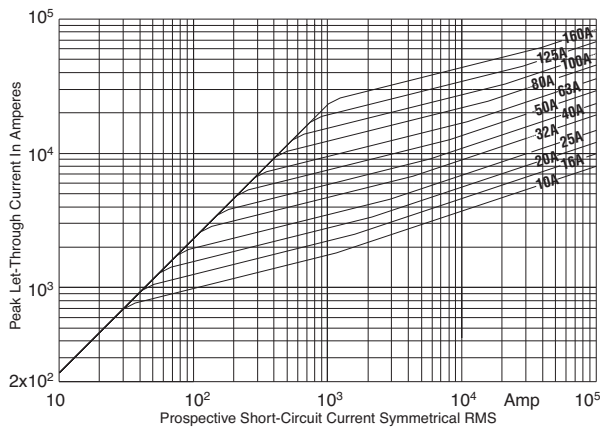

Peak Let-Through Curve

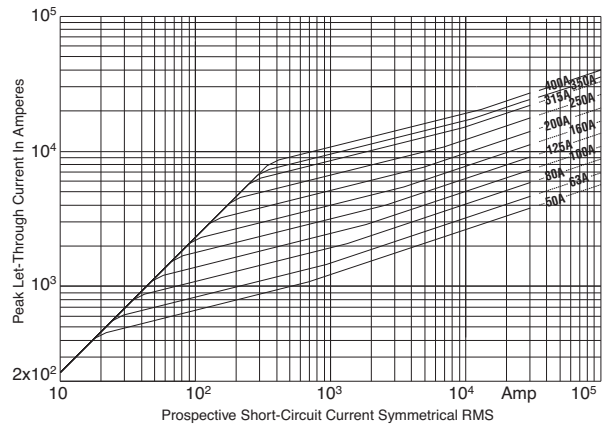

Square Body, DIN 43 620 - Size 2, 3 — 690V (IEC): 10-800A Class gR — Full Range Fuses

Size 2 — 200-630A: 690V
Time-Current Curve

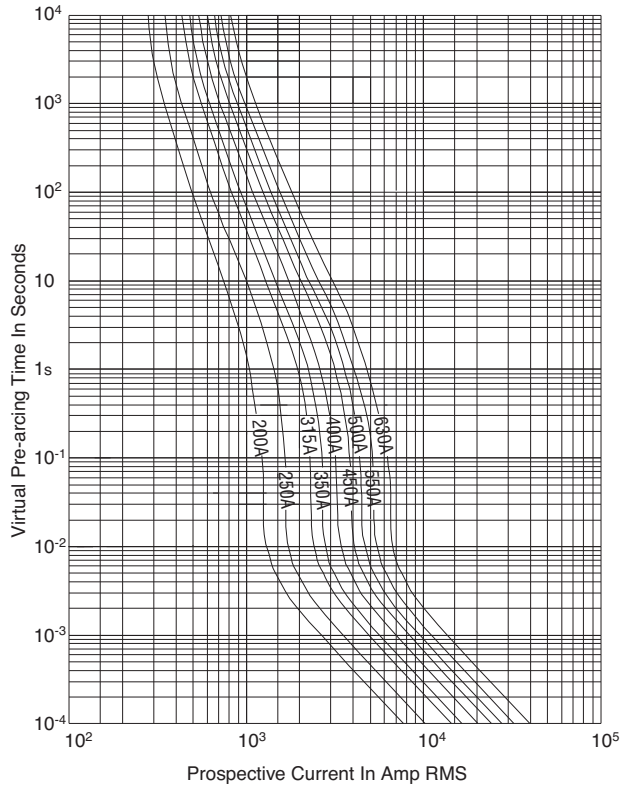

Size 3 — 350-800A: 690V
Time-Current Curve

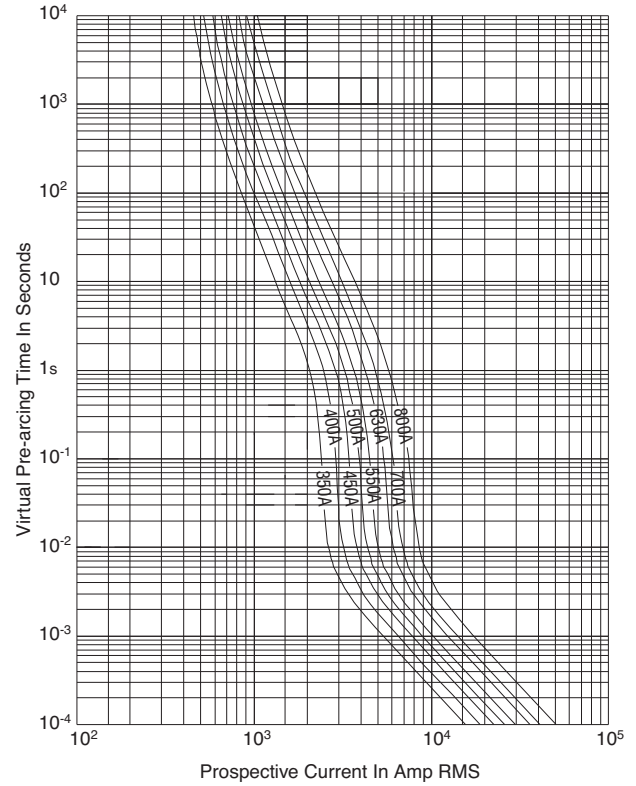

Peak Let-Through Curve

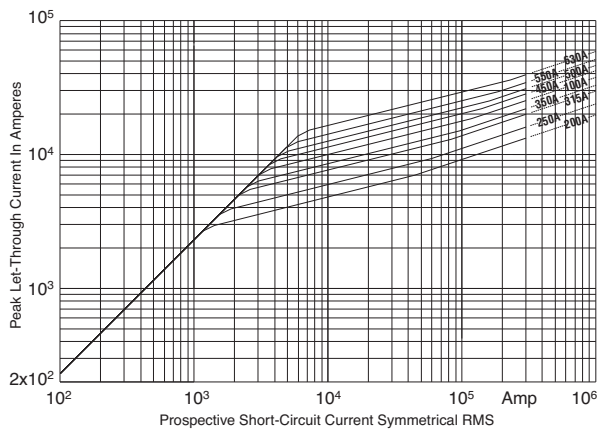

Peak Let-Through Curve

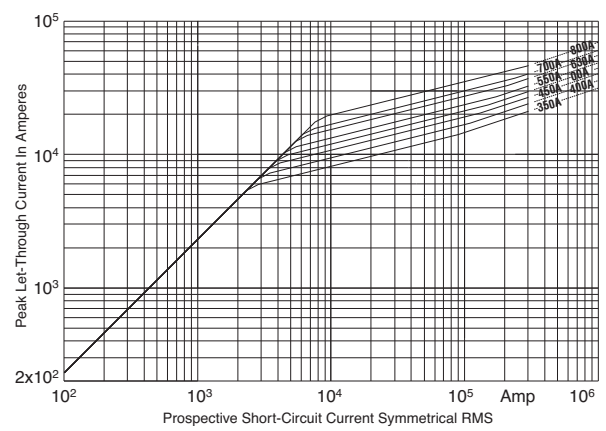

Square Body DIN 43 653 — 1000V (IEC): 20-315A

1000V (IEC) 20-315A

Specifications

Description: Square body DIN 43 653 stud-mount high speed fuses.

Dimensions: See dimensions illustration.

Ratings:

- Volts: — 1000Vac (20-250A)
- 900Vac (315A)
- Amps: — 20-315A
- IR: — 150kA RMS Sym.

Agency Information: CE, Designed and tested to IEC 60269: Part 4. UL Recognized E125085.JFHR2.

Electrical Characteristics

Total clearing I^2t

The total clearing I^2t at rated voltage and at power factor of 15% are given in the electrical characteristics. For other voltages, the clearing I^2t is found by multiplying by correction factor, K, given as a function of applied working voltage, E_g , (rms).

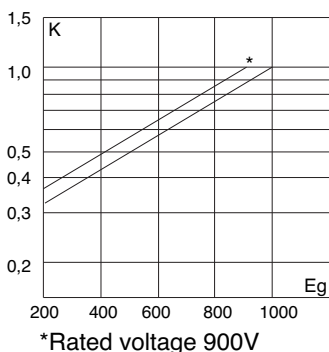

Arc Voltage

This curve gives the peak arc voltage, U_L , which may appear across the fuse during its operation as a function of the applied working voltage E_g , (rms) at a power factor of 15%.

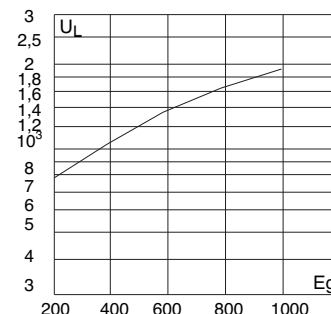

Power Losses

Watts loss at rated current is given in the electrical characteristics. The curve allows the calculation of the power losses at load currents lower than the rated current. The correction factor, K_p , is given as a function of the RMS load current, I_b , in % of the rated current.

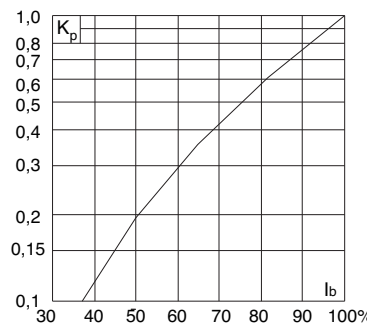

Features and Benefits

- Excellent DC performance
- Low arc voltage and low energy let-through (I^2t)
- Low watts loss
- Superior cycling capability

Typical Applications

- DC Common bus
- DC Drives
- Power converters/rectifiers
- Reduced voltage starters

For Other Voltage Ratings in This Body Style

- See page 145 (690V/700V)

Dimensions - mm

Type 00TN/80 – 00/80

Size	Max A	B	C	D	Max E	F	G	H
00/80	54	98	78	51	30	28	10	
00TN/80	54	98	78	51	30	28	67	10

1mm = 0.0394" / 1" = 25.4mm

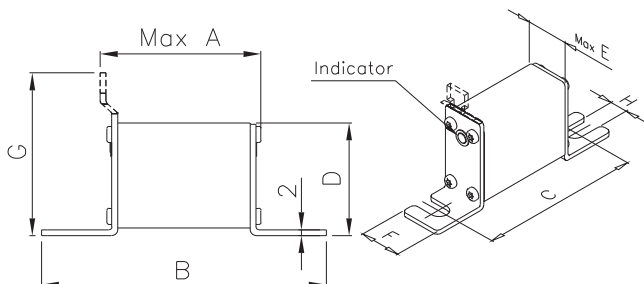

Square Body DIN 43 653 — 1000V (IEC): 20-315A

Catalog Numbers

Catalog Numbers		Size	Rated Voltage	Electrical Characteristics			
00/80 Visual Indicator for Micro	00TN/80 Type T Indicator for Micro			Rated Current RMS Amps	I ² t (A ² Sec)		Watts Loss
					Pre-arc	Clearing at Rated Voltage	
170M4802	170M4822	00	1000	20	20	140	5
170M4803	170M4823			25	30	210	7
170M4804	170M4824			32	55	390	9
170M4805	170M4825			35	69	500	10
170M4806	170M4826			40	100	690	11
170M4807	170M4827			50	170	1200	13
170M4808	170M4828			63	280	2000	18
170M4809	170M4829			80	500	3500	22
170M4810	170M4830			100	950	6850	25
170M4811	170M4831			125	1500	11500	33
170M4812	170M4832			160	3000	22000	37
170M4813	170M4833			200	5600	40500	40
170M4814	170M4834			250	10000	74000	48
170M4815	170M4835			315	18000	115000	58

- Watts loss provided at rated current.
- Microswitch ordered separately. See accessories on page 212-213.

Size 00 — 20-315A: 1000V Time-Current Curve

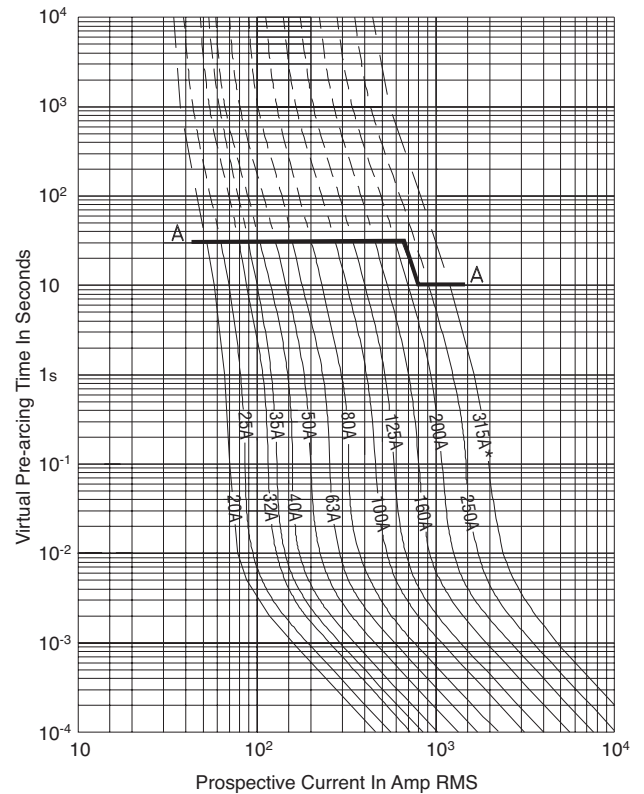

Peak Let-Through Curve

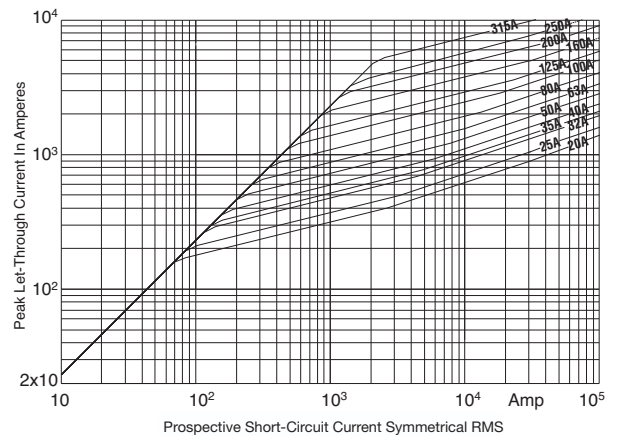

* 315A fuse is derated to 900V

Square Body DIN 43 653 — 1000V (IEC): 50-1400A

1000V (IEC) 50-1400A

Specifications

Description: Square body mount high speed fuses.

Dimensions: See dimensions illustrations.

Ratings:

Volts: — 1000Vac.

Amps: — 50-1400A

IR: — 125kA RMS Sym.

Agency Information: CE, Designed and tested to IEC 60269: Part 4. UL Recognized E125085.JFHR2.

Electrical Characteristics

Total clearing I²t

The total clearing I²t at rated voltage and at power factor of 15% are given in the electrical characteristics. For other voltages, the clearing I²t is found by multiplying by correction factor, K, given as a function of applied working voltage, E_g, (rms).

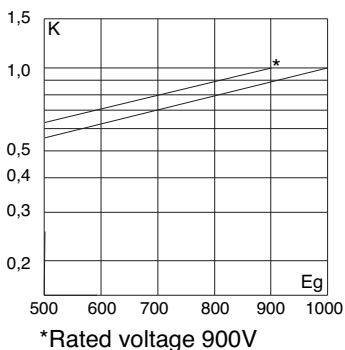

Arc Voltage

This curve gives the peak arc voltage, U_L, which may appear across the fuse during its operation as a function of the applied working voltage E_g, (rms) at a power factor of 15%.

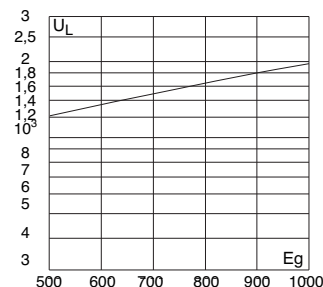

Power Losses

Watts loss at rated current is given in the electrical characteristics. The curve allows the calculation of the power losses at load currents lower than the rated current. The correction factor, K_p, is given as a function of the RMS load current, I_b, in % of the rated current.

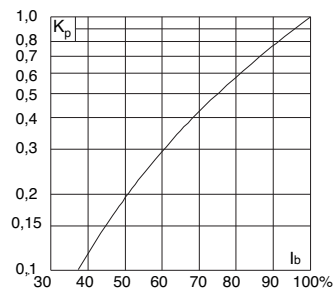

Features and Benefits

- Excellent DC performance
- Low arc voltage and low energy let-through (I²t)
- Low watts loss
- Superior cycling capability

Typical Applications

- DC Common bus
- DC Drives
- Power converters/rectifiers
- Reduced voltage starters

For Other Voltage Ratings in This Body Style

- See pages 150 (690V/700V) and 187 (1250V/1300V)

Dimensions - mm

Type -KN/110

Size	A	B	C	Max D1	E	G	H	I
1*KN/110	80	138	108	61	43	6	22	11
1KN/110	80	138	108	69	51	6	25	11
2KN/110	80	138	108	77	59	6	25	11
3KN/110	81	139	108	92	74	6	30	11

Type-KN/110

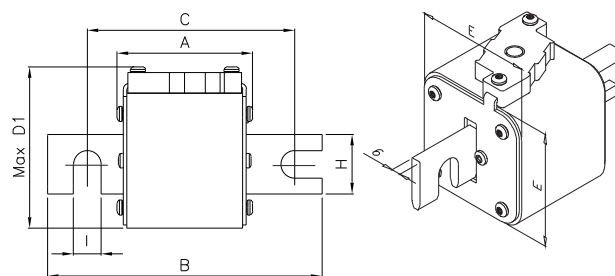

Type -TN/110

Size	A	B	C	Max D2	E	G	H	I
1*TN/110	80	138	108	61	43	6	22	11
1TN/110	80	138	108	69	51	6	25	11
2TN/110	80	138	108	75	59	6	25	11
3TN/110	81	139	108	90	74	6	30	11

1mm = 0.0394" / 1" = 25.4mm

Type-TN/110

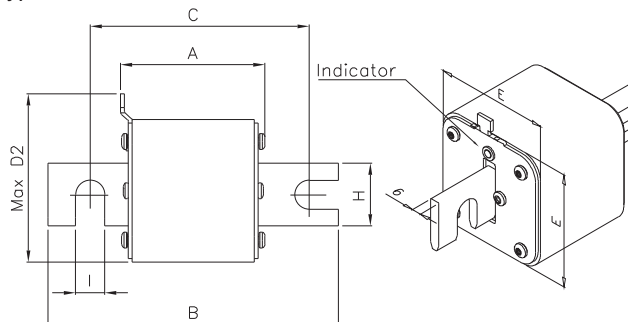

Square Body DIN 43 653 — 1000V (IEC): 50-1400A

Catalog Numbers

Catalog Numbers		Size	Rated Voltage	Electrical Characteristics			Watts Loss	
-KN/110 Type K Indicator for Micro	-TN/110 Type T Indicator for Micro			Rated Current RMS Amps	I ² t (A ² Sec)			
					Pre-arc	Clearing at Rated Voltage		
170M3965	170M3981	1*	1000	50	135	815	20	
170M3966	170M3982		1000	63	215	1300	25	
170M3967	170M3983		1000	80	460	2750	30	
170M3968	170M3984		1000	100	860	5100	35	
170M3969	170M3985		1000	125	1450	8600	40	
170M3970	170M3986		1000	160	2850	17500	45	
170M3971	170M3987		1000	200	4950	29500	48	
170M3972	170M3988		1000	250	9550	57000	50	
170M3973	170M3989		1000	315	21500	130000	60	
170M3974	170M3990		1000	350	29000	175000	65	
170M3975	170M3991		1000	400	42000	250000	70	
170M4965	170M4980		1	1000	160	2200	13500	40
170M4966	170M4981			1000	200	4150	24500	45
170M4967	170M4982	1000		250	7750	46000	52	
170M4968	170M4983	1000		315	16500	98500	60	
170M4969	170M4984	1000		350	21500	130000	65	
170M4970	170M4985	1000		400	31000	185000	70	
170M4971	170M4986	1000		450	44500	265000	80	
170M4972	170M4987	1000		500	63000	375000	85	
170M4973	170M4988	1000		550	84500	500000	90	
170M4974	170M4989	1000		630	125000	755000	98	
170M5966	170M5981	2	1000	250	6750	40000	65	
170M5967	170M5982		1000	315	13500	81500	75	
170M5968	170M5983		1000	350	16500	99000	80	
170M5969	170M5984		1000	400	26000	155000	85	
170M5970	170M5985		1000	450	35500	210000	90	
170M5971	170M5986		1000	500	49500	295000	95	
170M5972	170M5987		1000	550	66000	390000	100	
170M5973	170M5988		1000	630	93500	555000	110	
170M5974	170M5989		1000	700	130000	770000	115	
170M5975	170M5990		1000	800	195000	1200000	125	
170M8614	170M8629	3	1000	315	9200	54500	90	
170M8615	170M8630		1000	350	13000	77500	95	
170M8616	170M8631		1000	400	19000	115000	105	
170M8617	170M8632		1000	450	27000	160000	107	
170M8618	170M8633		1000	500	37500	225000	110	
170M8619	170M8634		1000	550	52000	310000	115	
170M8620	170M8635		1000	630	82500	490000	120	
170M8621	170M8636		1000	700	115000	700000	125	
170M8622	170M8637		1000	800	170000	1050000	135	
170M8623	170M8638		1000	900	250000	1500000	145	
170M8624	170M8639		1000	1000	340000	2050000	150	
170M8625	170M8640		1000	1100	460000	2750000	155	
170M8626	170M8641		1000	1250	575000	3400000	175	
170M8627	170M8642		900	1400	795000	4200000	185	

- Watts loss provided at rated current.
- Microswitch ordered separately. See accessories on page 212-213.
- For fuse curves see pages 180 and 181.

Square Body Flush End Contact — 1000V (IEC): 50–1400A

1000V (IEC) 50–1400A

Specifications

Description: Square body flush end contact high speed fuses.

Dimensions: See dimensions illustration.

Ratings:

Volts: — 1000Vac.

Amps: — 50-1400A

IR: — 150kA (Est. 300kA) RMS Sym.

Agency Information: CE, Designed and tested to IEC 60269: Part 4. UL Recognized E125085.JFHR2.

Electrical Characteristics

Total clearing I²t

The total clearing I²t at rated voltage and at power factor of 15% are given in the electrical characteristics. For other voltages, the clearing I²t is found by multiplying by correction factor, K, given as a function of applied working voltage, E_g, (rms).

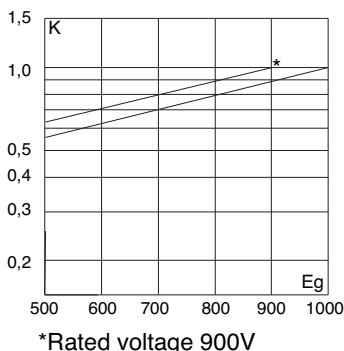

Arc Voltage

This curve gives the peak arc voltage, U_L, which may appear across the fuse during its operation as a function of the applied working voltage E_g, (rms) at a power factor of 15%.

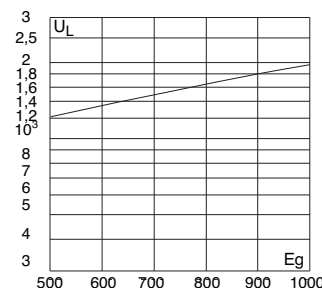

Power Losses

Watts loss at rated current is given in the electrical characteristics. The curve allows the calculation of the power losses at load currents lower than the rated current. The correction factor, K_p, is given as a function of the RMS load current, I_b, in % of the rated current.

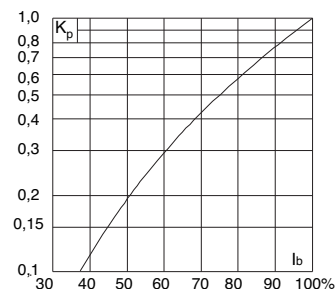

Features and Benefits

- Excellent DC performance
- Low arc voltage and low energy let-through (I²t)
- Low watts loss
- Superior cycling capability

Typical Applications

- DC Common bus
- DC Drives
- Power converters/rectifiers
- Reduced voltage starters

For Other Voltage Ratings in This Body Style

- See pages 152 (690V/700V) and 189 (1250V/1300V)

Dimensions - mm

Type -BKN/- and -GKN/-

Size	A	B	Max D	E	F	F* (in)	Min G	H
1*BKN/75+GKN/75	72.5	74	61	43	M8	5/16" - 18 UNC-2B	5	ø17.5
1BKN/75+GKN/75	73.2	74	69	52	M8	5/16" - 18 UNC-2B	8	ø20
2BKN/75+GKN/75	73.2	74.4	77	59	M10	3/8" - 16 UNC-2B	10	ø24
3BKN/75+GKN/75	73.3	75.4	92	74	M12	1/2" - 13 UNC-2B	10	ø30
3BKN/90+GKN/90	80.3	91.4	92	74	M12	1/2" - 13 UNC-2B	10	ø30

* Valid for fuses type -GKN/-.

1mm = 0.0394" / 1" = 25.4mm

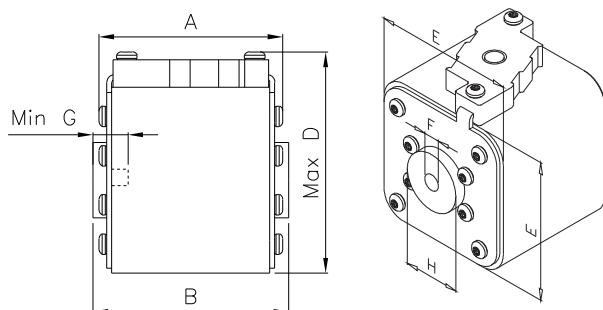

Square Body Flush End Contact — 1000V (IEC): 50–1400A

Catalog Numbers

Catalog Numbers		Size	Electrical Characteristics				
-BKN/- Type K Indicator for Micro	-GKN/- Type K Indicator for Micro		Rated Voltage	Rated Current RMS-Amps	I ² t (A ² Sec)		Watts Loss
					Pre-arc	Clearing at Rated Voltage	
170M3951	170M3921	1*	1000	50	135	815	20
170M3952	170M3922		1000	63	215	1300	25
170M3953	170M3923		1000	80	460	2750	30
170M3954	170M3924		1000	100	860	5100	35
170M3955	170M3925		1000	125	1450	8600	40
170M3956	170M3926		1000	160	2850	17500	45
170M3957	170M3927		1000	200	4950	29500	48
170M3958	170M3928		1000	250	9550	57000	50
170M3959	170M3929		1000	315	21500	130000	60
170M3960	170M3930		1000	350	29000	175000	65
170M3961	170M3931	1000	400	42000	250000	70	
170M4951	170M4921	1	1000	160	2200	13500	40
170M4952	170M4922		1000	200	4150	24500	45
170M4953	170M4923		1000	250	7750	46000	52
170M4954	170M4924		1000	315	16500	98500	60
170M4955	170M4925		1000	350	21500	130000	65
170M4956	170M4926		1000	400	31000	185000	70
170M4957	170M4927		1000	450	44500	265000	80
170M4958	170M4928		1000	500	63000	375000	85
170M4959	170M4929		1000	550	84500	500000	90
170M4960	170M4930		1000	630	125000	755000	98
170M5952	170M5922	2	1000	250	6750	40000	65
170M5953	170M5923		1000	315	13500	81500	75
170M5954	170M5924		1000	350	16500	99000	80
170M5955	170M5925		1000	400	26000	155000	85
170M5956	170M5926		1000	450	35500	210000	90
170M5957	170M5927		1000	500	49500	295000	95
170M5958	170M5928		1000	550	66000	390000	100
170M5959	170M5929		1000	630	93500	555000	110
170M5960	170M5930		1000	700	130000	770000	115
170M5961	170M5931		1000	800	195000	1200000	125
170M8600	170M8500	3	1000	315	9200	54500	90
170M8601	170M8501		1000	350	13000	77500	95
170M8602	170M8502		1000	400	19000	115000	105
170M8603	170M8503		1000	450	27000	160000	107
170M8604	170M8504		1000	500	37500	225000	110
170M8605	170M8505		1000	550	52000	310000	115
170M8606	170M8506		1000	630	82500	490000	120
170M8607	170M8507		1000	700	115000	700000	125
170M8608	170M8508		1000	800	170000	1050000	135
170M8609	170M8509		1000	900	250000	1500000	145
170M8610	170M8510		1000	1000	340000	2050000	150
170M8611	170M8511		1000	1100	460000	2750000	155
170M8612**	170M8512**		1000	1250	575000	3400000	175
170M8613**	170M8513**	900	1400	795000	4200000	185	

- **Overall length is 90mm, for all other fuses the overall length is 75mm.
- Watts loss provided at rated current.
 - Microswitch ordered separately. See accessories on page 212-213.
 - For fuse curves see pages 180 and 181.

Square Body US style — 1000V (IEC): 50-1400A

1000V (IEC) 50-1400A

Specifications

Description: Square body US style high speed fuses.

Dimensions: See dimensions illustration.

Ratings:

- Volts: — 1000Vac.
- Amps: — 50-1400A
- IR: — 150kA RMS Sym.

Agency Information: CE, Designed and tested to IEC 60269: Part 4. UL Recognized E125085.JFHR2.

Electrical Characteristics

Total clearing I^2t

The total clearing I^2t at rated voltage and at power factor of 15% are given in the electrical characteristics. For other voltages, the clearing I^2t is found by multiplying by correction factor, K, given as a function of applied working voltage, E_g , (rms).

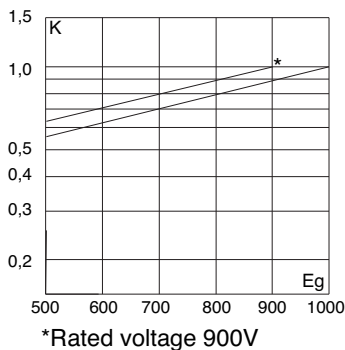

Arc Voltage

This curve gives the peak arc voltage, U_L , which may appear across the fuse during its operation as a function of the applied working voltage E_g , (rms) at a power factor of 15%.

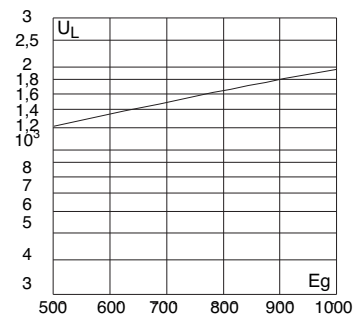

Power Losses

Watts loss at rated current is given in the electrical characteristics. The curve allows the calculation of the power losses at load currents lower than the rated current. The correction factor, K_p , is given as a function of the RMS load current, I_b , in % of the rated current.

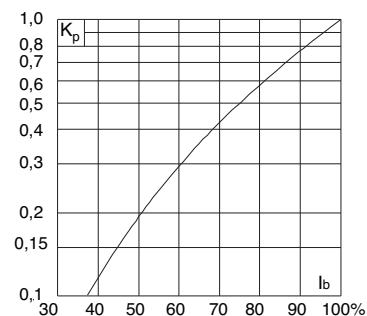

Features and Benefits

- Excellent DC performance
- Low arc voltage and low energy let-through (I^2t)
- Low watts loss
- Superior cycling capability

Typical Applications

- DC Common bus
- DC Drives
- Power converters/rectifiers
- Reduced voltage starters

Dimensions - mm

Type -FKE/115

Size	B	C1	C2	D	E	H	I
1*FKE/115	156	130	101	59	45	20	10
1FKE/115	160	127	102	69	53	25	14
2FKE/115	160	127	102	77	61	25	14
3FKE/115	159	128	101	92	76	36	16

1mm = 0.0394" / 1" = 25.4mm

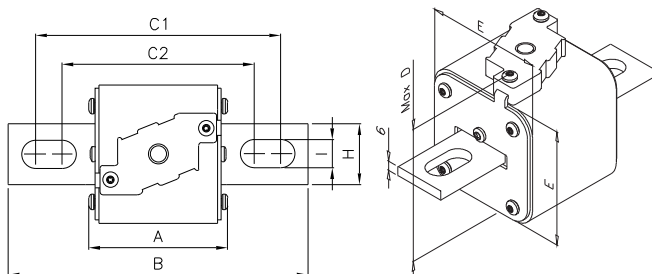

For Other Voltage Ratings in This Body Style

- See pages 154 (690V/700V) and 191 (1250V/1300)

Square Body US style — 1000V (IEC): 50-1400A

Catalog Numbers

Catalog Numbers -FKE/115 Type K Indicator for Micro	Size	Electrical Characteristics			
		Rated Current RMS-Amps	I ² t (A ² Sec)		Watts Loss
			Pre-arc	Clearing at 1000V	
170M3531	1*	50	135	815	20
170M3532		63	215	1300	25
170M3533		80	460	2750	30
170M3534		100	860	5100	35
170M3535		125	1450	8600	40
170M3536		160	2850	17500	45
170M3537		200	4950	29500	48
170M3538		250	9550	57000	50
170M3539		315	21500	130000	60
170M3540		350	29000	175000	65
170M3541	400	42000	250000	70	
170M4531	1	160	2200	13500	40
170M4532		200	4150	24500	45
170M4533		250	7750	46000	52
170M4534		315	16500	98500	60
170M4535		350	21500	130000	65
170M4536		400	31000	185000	70
170M4537		450	44500	265000	80
170M4538		500	63000	375000	85
170M4539		550	84500	500000	90
170M4540		630	125000	755000	98
170M5531	2	250	6750	40000	65
170M5532		315	13500	81500	75
170M5533		350	16500	99000	80
170M5534		400	26000	155000	85
170M5535		450	35500	210000	90
170M5536		500	49500	295000	95
170M5537		550	66000	390000	100
170M5538		630	93500	555000	110
170M5539		700	130000	770000	115
170M5540		800	195000	1200000	125
170M8531	3	315	9200	54500	90
170M8532		350	13000	77500	95
170M8533		400	19000	115000	105
170M8534		450	27000	160000	107
170M8535		500	37500	225000	110
170M8536		550	52000	310000	115
170M8537		630	82500	490000	120
170M8538		700	115000	700000	125
170M8539		800	170000	1050000	135
170M8540		900	250000	1500000	145
170M8541		1000	340000	2050000	150
170M8542		1100	460000	2750000	155
170M8543		1250	575000	3400000	175
170M8544*		1400	795000	4200000*	185

- * Rated voltage 900V.
- Watts loss provided at rated current.
- Microswitch ordered separately. See accessories on pages 212-213.
- For fuse curves see pages 180 and 181.

Square Body, US style - Size 1*, 1 — 1000V (IEC): 50-1400A

Size 1* — 50-400A: 1000V
Time-Current Curve

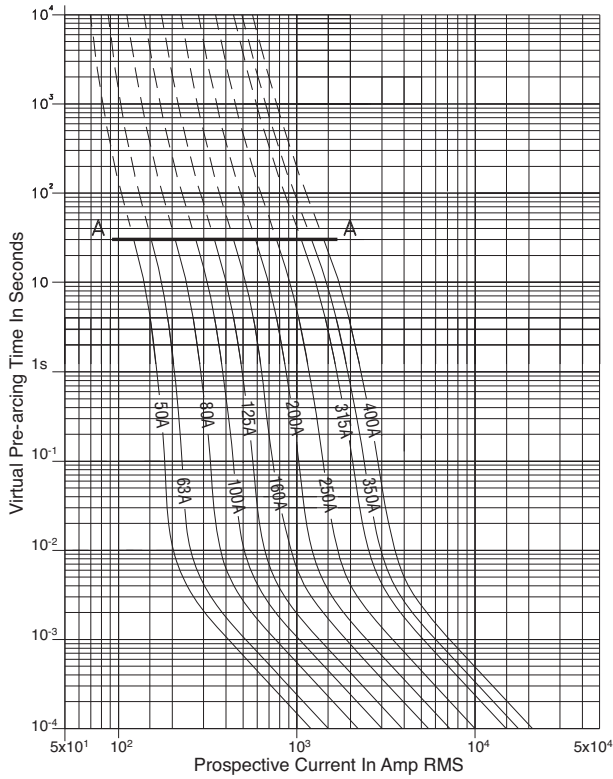

Size 1 — 160-630A: 1000V
Time-Current Curve

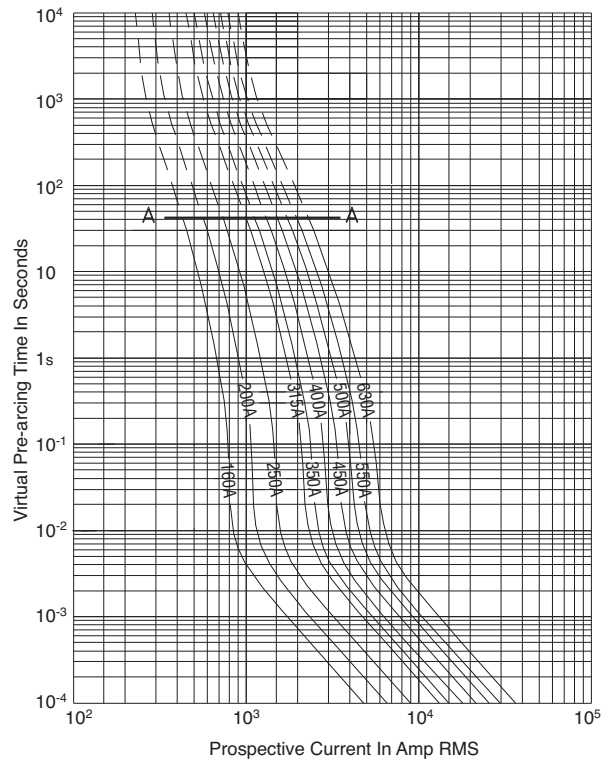

Peak Let-Through Curve

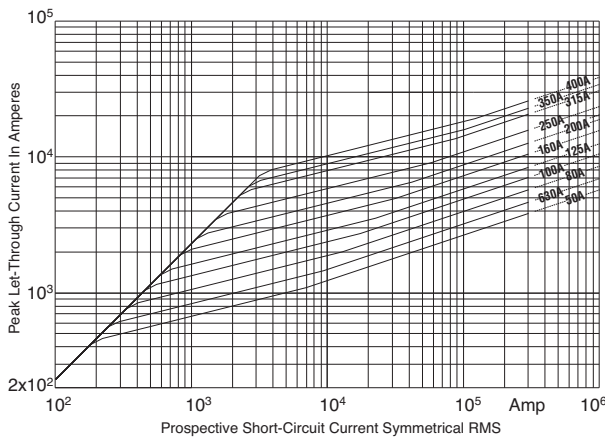

Peak Let-Through Curve

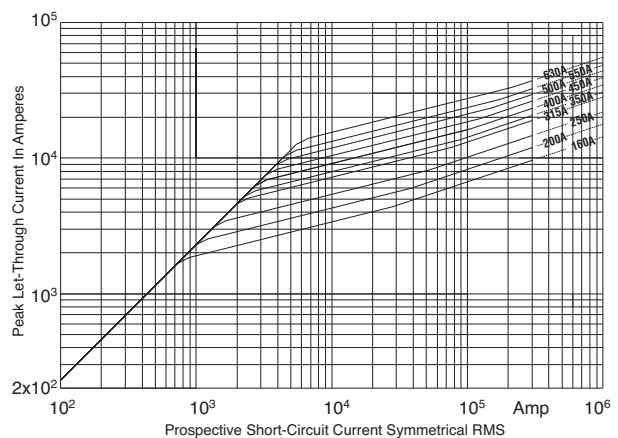

Square Body, US style - Size 2, 3 — 1000V (IEC): 50-1400A

Size 2 — 250-800A: 1000V
Time-Current Curve

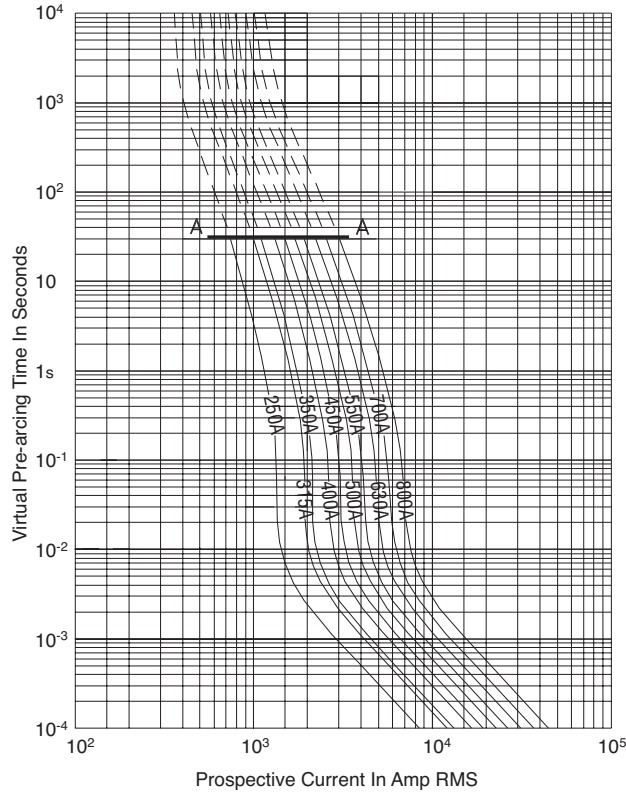

Size 3 — 315-1400A: 1000V
Time-Current Curve

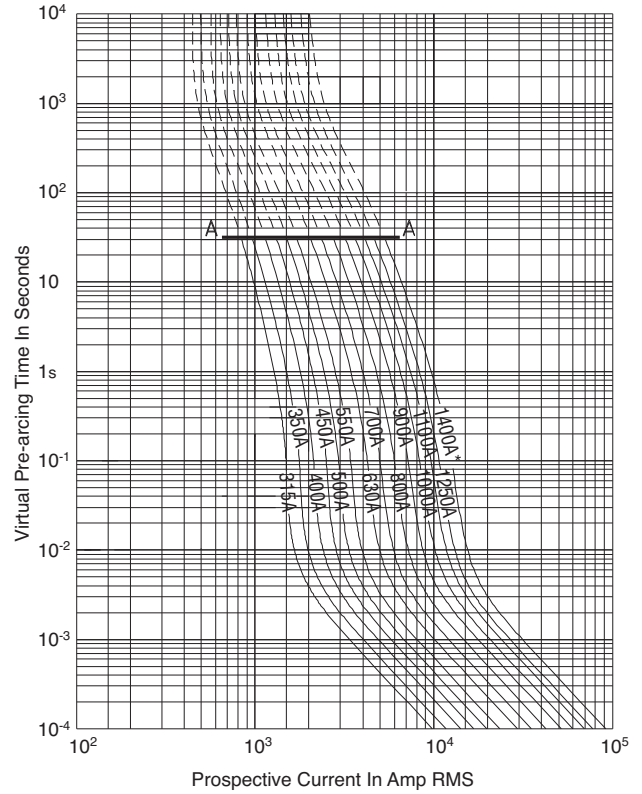

Peak Let-Through Curve

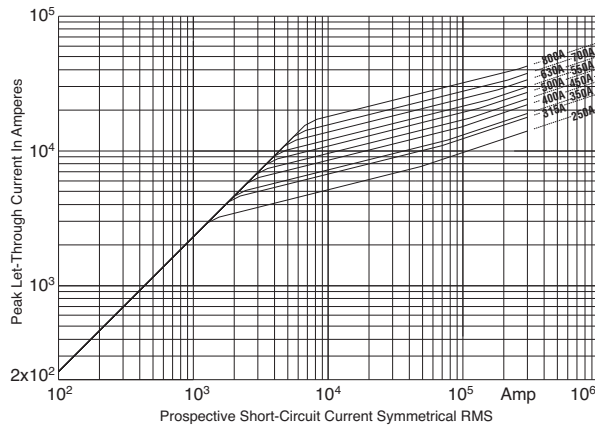

Peak Let-Through Curve

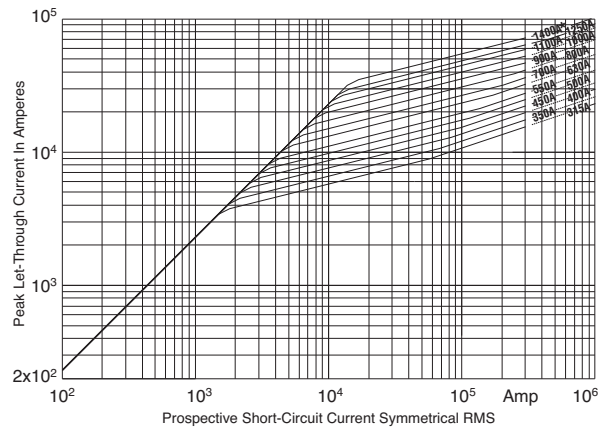

Square Body Flush End Contact Size 4 — 1000V (IEC): 1000-2700A

1000V (IEC) 1000-2700A

Specifications

Description: Square body DIN 43 620 blade style high speed fuses.

Dimensions: See dimensions illustration.

Ratings:

Volts: — 1000Vac (IEC)

Amps: — 1000-2700A

IR: — 125kA RMS Sym.

Agency Information: CE, Designed and tested to IEC 60269: Part 4. UL Recognized E125085.JFHR2.

Electrical Characteristics

Total clearing I²t

The total clearing I²t at rated voltage and at power factor of 15% are given in the electrical characteristics. For other voltages, the clearing I²t is found by multiplying by correction factor, K, given as a function of applied working voltage, E_g, (rms).

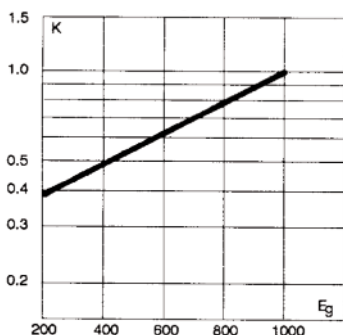

Arc Voltage

This curve gives the peak arc voltage, U_L, which may appear across the fuse during its operation as a function of the applied working voltage E_g, (rms) at a power factor of 15%.

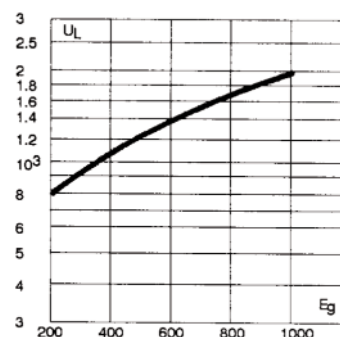

Power Losses

Watts loss at rated current is given in the electrical characteristics. The curve allows the calculation of the power losses at load currents lower than the rated current. The correction factor, K_p, is given as a function of the RMS load current, I_b, in % of the rated current.

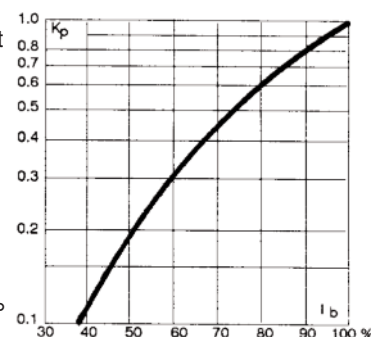

Features and Benefits

- Excellent DC performance
- Low arc voltage and low energy let-through (I²t)
- Low watts loss
- Superior cycling capability

Typical Applications

- DC Common bus
- DC Drives
- Power converters/rectifiers
- Reduced voltage starters

For Other Voltage Ratings in This Body Style

- See pages 163 (690V/700V) and 195 (1250V)

Catalog Numbers

Fuse Size	Catalog Number		Electrical Characteristics				
	-BKN/95 Type K Indicator	-SBKN/90 Type K Indicator	Rated Voltage (V)	Rated Current RMS-Amp	I ² t (A ² Sec)		Watt Loss (W)
					Pre-arc	Clearing at 1000V	
4	—	170M7542	1000	1000	180000	1100000	195
	—	170M7031		1100	250000	1500000	200
	170M7636	170M7548		1500	600000	3600000	250
	170M7639	170M7034		1700	850000	5000000	260
	170M7963	170M7544		2000	1450000	8600000	270
	170M7090	170M7035		2200	2000000	12000000	280
	170M7640	170M7036		2500	3000000	18000000	295
	170M7658	170M7037		2700	3700000	22000000	310

Square Body Flush End Contact Size 4 — 1000V (IEC): 1000-2700A

Dimensions - mm

Type 4BKN 95

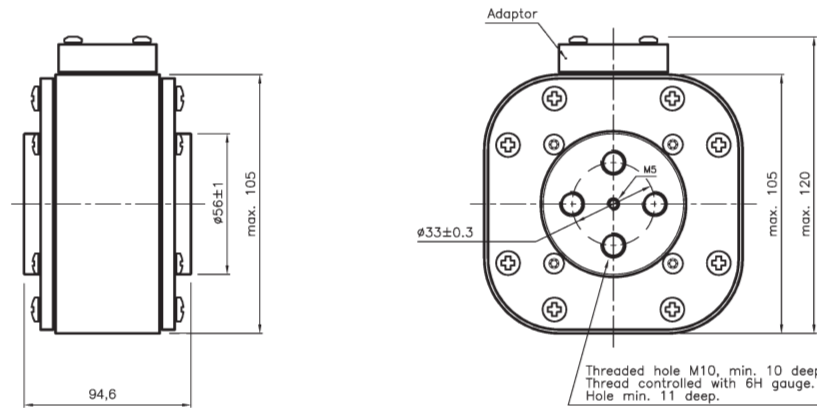

Type 4SBKN 95

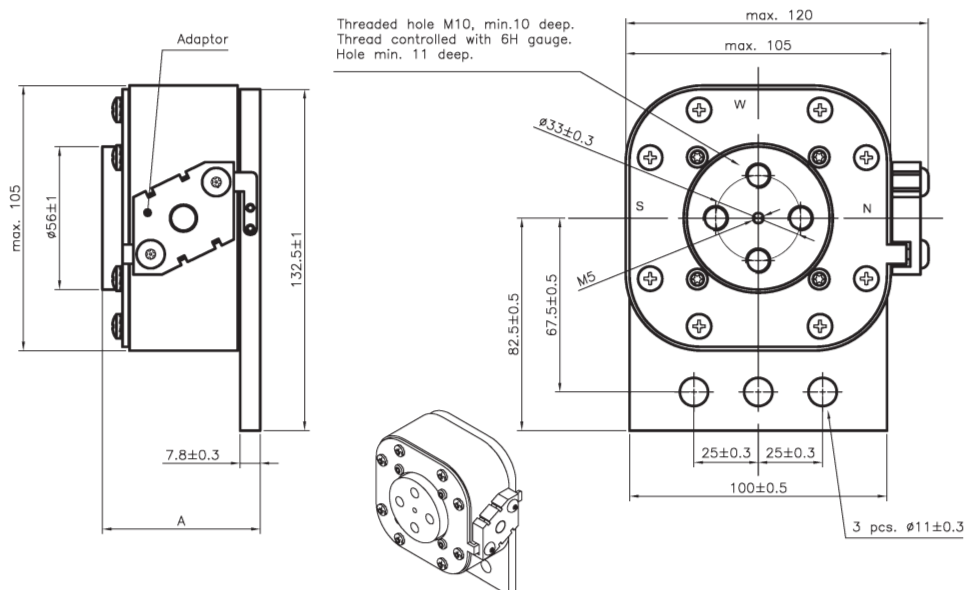

High Speed
Fuses

Square Body Flush End Contact Size 4 — 1000V (IEC): 1000-2700A

Size 4 — 1000-2700A: 660V
Time-Current Curve

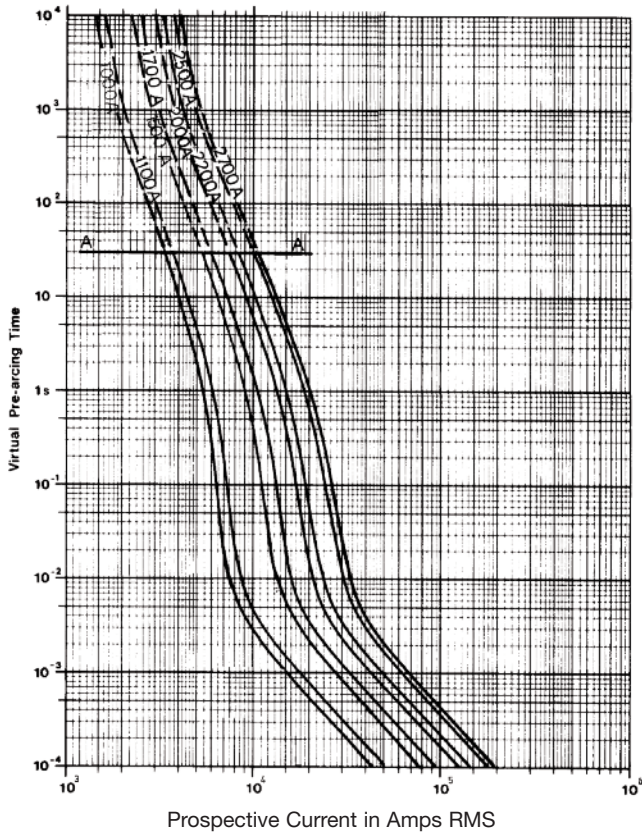

Peak Let-Through Curve

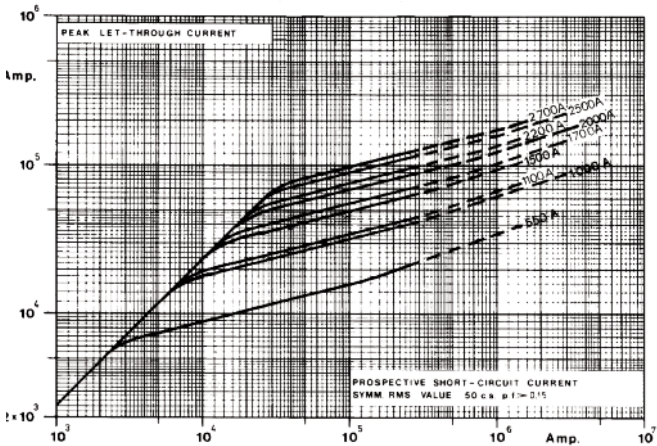

Data Sheet: Available upon request

Square Body Flush End Contact Size 24 — 1000V (IEC): 2000-5000A

1000V (IEC) 2000-5000A

Specifications

Description: High speed square body fuses, for the protection of the power rectifier section of the equipment.

Dimensions: See dimensions illustration.

Ratings:

Volts: — 1000Vac

Amps: — 2000-5000A

IR: — 300kA RMS Sym.

Agency Information: CE, Designed and tested to IEC 60269: Part 4. UL Recognized E125085.JFHR2.



Electrical Characteristics

Total clearing I²t

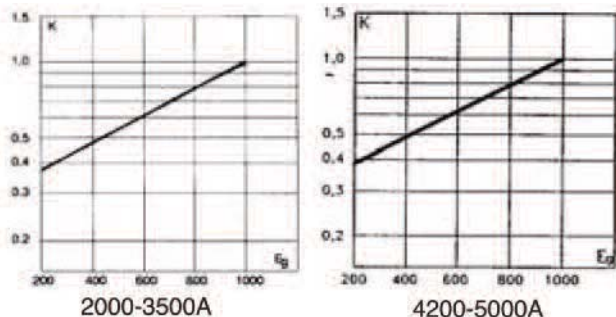

The total clearing I²t at rated voltage and at power factor of 15% are given in the electrical characteristics. For other voltages, the clearing I²t is found by multiplying by correction factor, K, given as a function of applied working voltage, E_g, (rms).

Features and Benefits

- Low watts loss
- Superior cycling capability

Typical Applications

- Power converters/rectifiers
- Reduced voltage starters

Arc Voltage

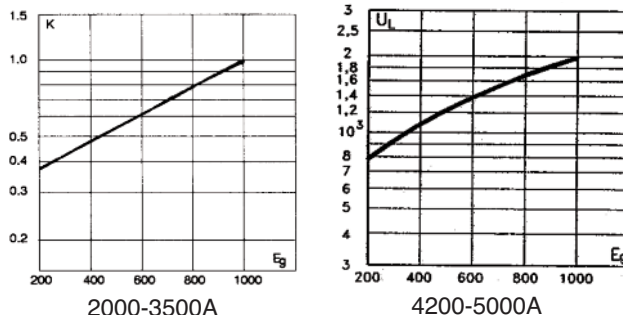

This curve gives the peak arc voltage, U_L, which may appear across the fuse during its operation as a function of the applied working voltage E_g, (rms) at a power factor of 15%.

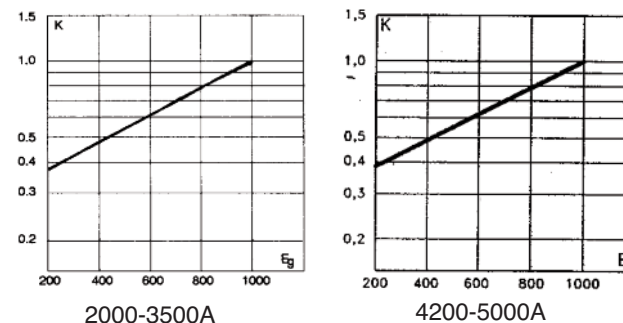

Power Losses

Watts loss at rated current is given in the electrical characteristics. The curve allows the calculation of the power losses at load currents lower than the rated current. The correction factor, K_p, is given as a function of the RMS load current, I_b, in % of the rated current.

For Other Voltage Ratings in This Body Style

- See pages 165 (660V) and 198 (1250V)

Dimensions - mm

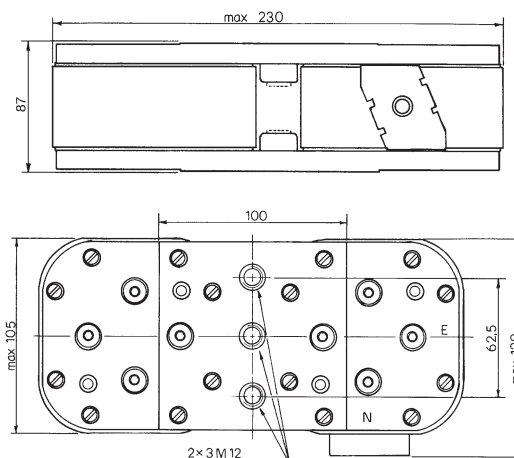

Catalog Numbers

Fuse Size	Cat. Number	Electrical Characteristics				
		Rated Voltage (V)	Rated Current RMS-Amp	I ² t (A ² Sec)		Watt Loss (W)
				Pre-arc	Clearing at 1000V	
24	170M7608	1000	2000	885000	5700000	345
	170M7680		3000	2900000	19000000	430
	170M7567		3200	3300000	20000000	440
	170M7568		3500	4500000	27000000	450
	170M7569		4000	6800000	40000000	475
	170M7498		4200	8000000	47500000	485
	170M7488		4500	10000000	59000000	495
	170M7622		5000	14000000	82500000	540

Data Sheet: 170K7540, 170K8514

Square Body Flush End Contact Size 24 — 1000V (IEC): 2000-5000A

Size 24 — 2000-3500A: 1000V
Time-Current Curve

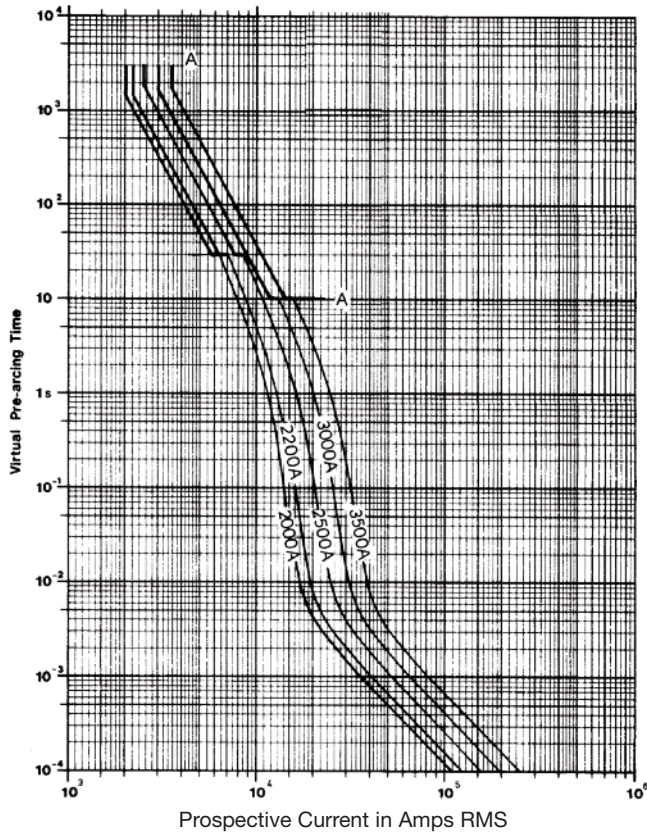

Size 24 — 4200-5000A: 1000V
Time-Current Curve

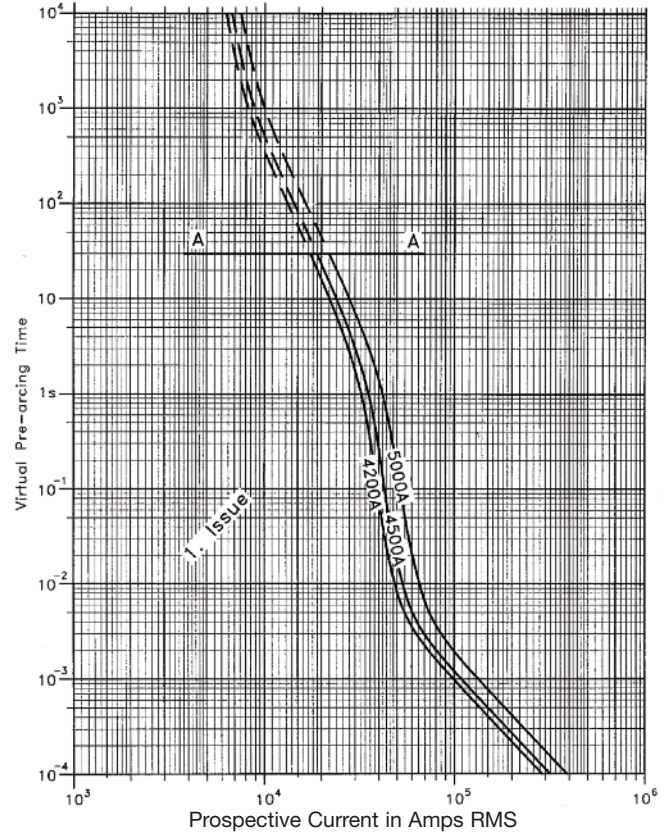

Peak Let-Through Curve

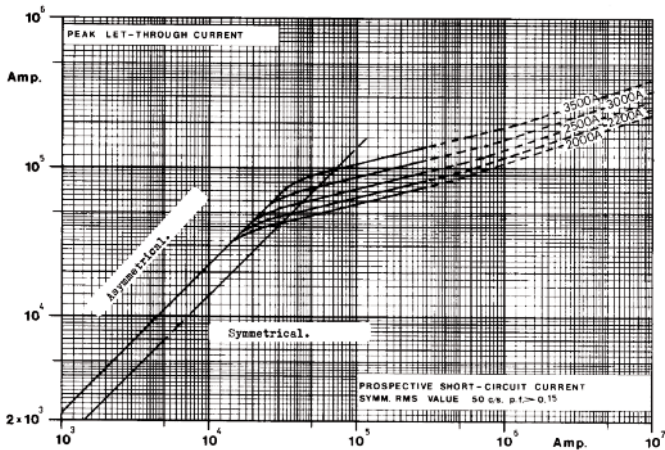

Peak Let-Through Curve

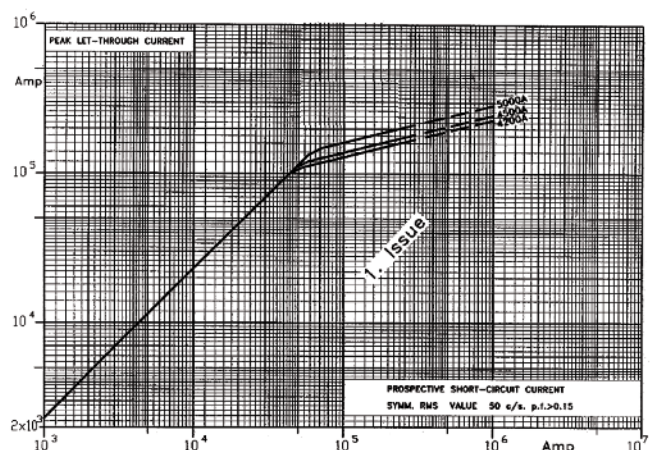

Data Sheet: Available upon request

Data Sheet: Available upon request

Square Body DIN 43 653 — 1250V/1300V (IEC/UL): 50-1400A

1250V/1300V (IEC/UL) 50-1400A

Specifications

Description: Square body DIN 43 653 stud-mount high speed fuses.

Dimensions: See dimensions illustration.

Ratings:

Volts: — 1250Vac (IEC)
— 1300Vac (UL)

Amps: — 50-1400A

IR: — 100kA RMS Sym.

Agency Information: CE, Designed and tested to IEC 60269: Part 4. UL Recognized E125085.JFHR2, CSA Certified: Class 53787, File 1422-30.

Electrical Characteristics

Total Clearing I²t

The total clearing I²t at rated voltage and at power factor of 15% are given in the electrical characteristics. For other voltages, the clearing I²t is found by multiplying by correction factor, K, given as a function of applied working voltage, E_g, (rms).

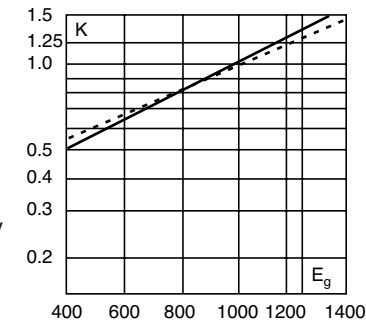

Dashed lines (-----) apply to the following amperages:

Size	Amps.
1*	400A
1	500-630A
2	630-1000A
3	800-1400A



Arc Voltage

This curve gives the peak arc voltage, U_L, which may appear across the fuse during its operation as a function of the applied working voltage, E_g, (rms) at a power factor of 15%.

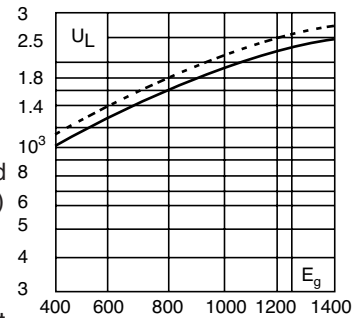

Power Losses

Watts loss at rated current is given in the electrical characteristics. The curve allows the calculation of the power losses at load currents lower than the rated current. The correction factor, K_p, is given as a function of the RMS load current, I_b, in % of the rated current.

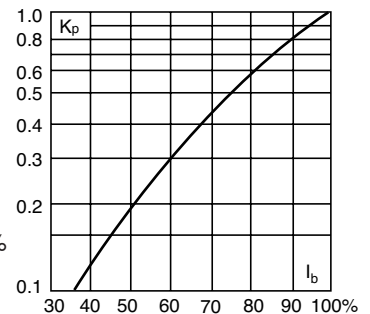

Features and Benefits

- Excellent DC performance
- Low arc voltage and low energy let-through (I²t)
- Low watts loss
- Superior cycling capability

Typical Applications

- DC Common bus
- DC Drives
- Power converters/rectifiers
- Reduced voltage starters

For Other Voltage Ratings in This Body Style

- See pages 150 (690V/700V) and 176 (1000V)

Dimensions - mm

Type -/110, -TN/110

Size	A	B	D**	E	H
1*	80	138	58	45	20
1	80	138	66	53	25
2	80	138	75	61	25
3	81	139	90	76	30

**Microswitch.

1mm = 0.0394" / 1" = 25.4mm

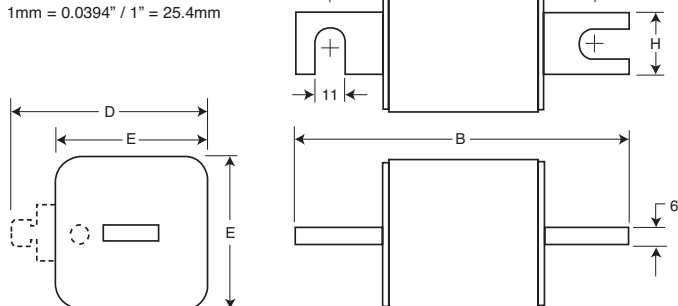

Type -KN/110

Size	A	B	D	E	H
1*	80	138	58	45	20
1	80	138	66	53	25
2	80	138	75	61	25
3	81	139	90	76	30

1mm = 0.0394" / 1" = 25.4mm

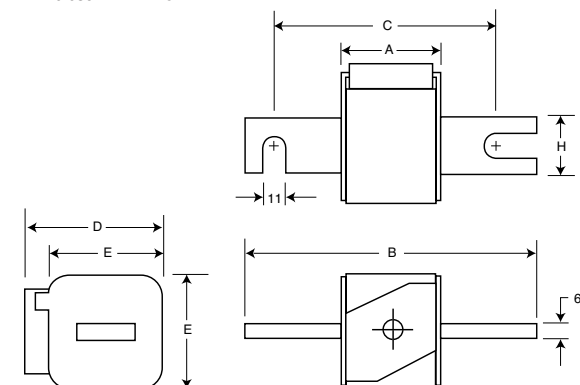

Square Body DIN 43 653 — 1250V/1300V (IEC/UL): 50-1400A

Catalog Numbers

Catalog Numbers								
-/110 Visual Indicator	-TN/110 Type T Indicator for Micro	-KN/110 Type K Indicator for Micro	Size	Electrical Characteristics				Watts Loss
				Rated Current RMS-Amps	I ² t (A ² Sec)			
					Pre-arc	Clearing at 1000V	Clearing at 1250V	
170M3138	170M3188	170M3238	1*	50	135	815	1100	15
170M3139	170M3189	170M3239		63	215	1300	1750	20
170M3140	170M3190	170M3240		80	420	2500	3350	25
170M3141	170M3191	170M3241		100	750	4450	5950	30
170M3142	170M3192	170M3242		125	1450	9000	11500	35
170M3143	170M3193	170M3243		160	2600	16000	21000	40
170M3144	170M3194	170M3244		200	5150	31000	41000	45
170M3145	170M3195	170M3245		250	9200	54500	73000	55
170M3146	170M3196	170M3246		315	18500	115000	150000	60
170M3147	170M3197	170M3247		350	27000	165000	220000	65
170M3148	170M3198	170M3248	400	53000	265000	335000	70	
170M4138	170M4188	170M4238	1	160	1900	11500	15500	45
170M4139	170M4189	170M4239		200	3800	22500	30000	50
170M4140	170M4190	170M4240		250	7750	46000	61500	60
170M4141	170M4191	170M4241		315	15000	90000	120000	65
170M4142	170M4192	170M4242		350	20000	125000	165000	70
170M4143	170M4193	170M4243		400	29500	175000	235000	75
170M4144	170M4194	170M4244		450	42000	250000	335000	80
170M4145	170M4195	170M4245		500	69500	340000	435000	85
170M4146	170M4196	170M4246		550	95000	465000	590000	95
170M4147	170M4197	170M4247		630†	130000	660000		100
170M5138	170M5188	170M5238	2	250	6500	38500	51500	65
170M5139	170M5189	170M5239		280	9350	55500	74500	70
170M5140	170M5190	170M5240		315	13000	77500	105000	75
170M5141	170M5191	170M5241		350	16500	97500	135000	80
170M5142	170M5192	170M5242		400	23000	140000	180000	85
170M5143	170M5193	170M5243		450	34000	205000	270000	90
170M5144	170M5194	170M5244		500	48000	285000	380000	95
170M5145	170M5195	170M5245		550	62000	370000	495000	100
170M5146	170M5196	170M5246		630	115000	575000	730000	110
170M5147	170M5197	170M5247		700	160000	795000	1050000	115
170M5148	170M5198	170M5248	800	245000	1200000	1550000	120	
170M5149	170M5199	170M5249	900‡	360000	1750000		125	
170M5150	170M5200	170M5250	1000‡	480000	2350000		135	
170M6138	170M6188	170M6238	3	315	9500	58000	77500	85
170M6139	170M6189	170M6239		350	13500	81500	110000	90
170M6140	170M6190	170M6240		400	19500	120000	160000	95
170M6141	170M6191	170M6241		450	31000	185000	245000	100
170M6142	170M6192	170M6242		500	39000	235000	310000	105
170M6143	170M6193	170M6243		550	55000	325000	435000	110
170M6144	170M6194	170M6244		630	83500	495000	665000	115
170M6145	170M6195	170M6245		700	115000	705000	940000	120
170M6146	170M6196	170M6246		800‡	205000	995000	1300000	125
170M6147	170M6197	170M6247		900‡	305000	1500000	1900000	130
170M6148	170M6198	170M6248	1000‡	450000	2150000	2750000	135	
170M6149	170M6199	170M6249	1100‡	575000	2800000	3600000	140	
170M6150	170M6200	170M6250	1250‡	810000	3950000		145	
170M6151	170M6201	170M6251	1400‡	1250000	6000000		150	

†Rated voltage (IEC) 1100V.

‡Rated voltage (IEC) 1250V.

• Watts loss provided at rated current.

• Microswitch indicator ordered separately. See accessories on pages 212-213.

• For fuse curves see pages 193 and 194.

Square Body Flush End Contact — 1250V/1300V (IEC/UL): 50-1400A

1250V/1300V (IEC/UL) 50-1400A

Specifications

Description: Square body flush end contact high speed fuses.

Dimensions: See dimensions illustrations.

Ratings:

Volts: — 1250Vac (IEC)
— 1300Vac (UL)

Amps: — 50-1400A

IR: — 100kA RMS Sym.

Agency Information: CE, Designed and tested to IEC 60269: Part 4. UL Recognized E125085.JFHR2, CSA Certified: Class 53787, File 1422-30.

Electrical Characteristics

Total Clearing I²t

The total clearing I²t at rated voltage and at power factor of 15% are given in the electrical characteristics. For other voltages, the clearing I²t is found by multiplying by correction factor, K, given as a function of applied working voltage, E_g, (rms).

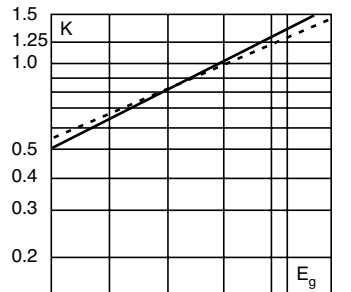

Dashed lines (---) apply to the following amperages:.

Size	Amps.
1*	400A
1	500-630A
2	630-1000A
3	800-1400A

Dimensions - mm

Type -BKN/-, -GKN/-

Size	Type	A	B	D	E	F	F** (in)	G	H
1*	BKN + GKN/75	74	75	59	45	M8	5/16" - 18 UNC-2B	5	Ø17
1*	BKN/80	80	81	59	45	M8		5	Ø17
1	BKN + GKN/75	74	75	69	53	M8	5/16" - 18 UNC-2B	8	Ø20
1	BKN/80	80	81	69	53	M8		8	Ø20
2	BKN + GKN/75	74	75	77	61	M10	3/8" - 16 UNC-2B	10	Ø24
2	BKN/80	80	81	77	61	M10		10	Ø24
2	BKN + GKN/90	80	91	77	61	M10	3/8" - 16 UNC-2B	10	Ø24
3	BKN + GKN/75	74	76	92	76	M12	1/2" - 13 UNC-2B	10	Ø30
3	BKN/80	81	83	92	76	M12		10	Ø30
3	BKN + GKN/90	81	91	92	76	M12	1/2" - 13 UNC-2B	10	Ø30

**Valid for fuses type -GKN/-.
1mm = 0.0394" / 1" = 25.4mm

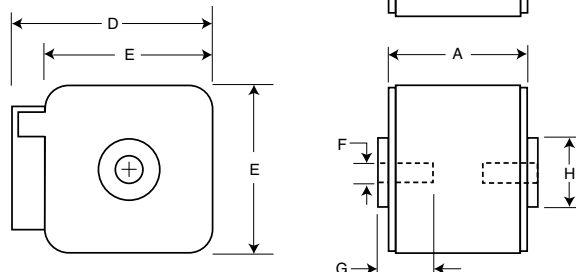

Arc Voltage

This curve gives the peak arc voltage, U_L, which may appear across the fuse during its operation as a function of the applied working voltage, E_g, (rms) at a power factor of 15%.

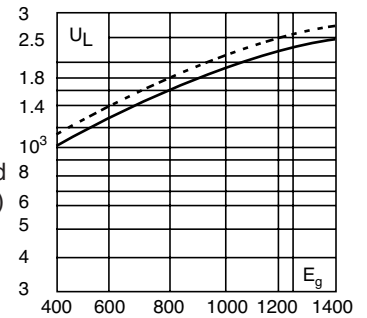

Power Losses

Watts loss at rated current is given in the electrical characteristics. The curve allows the calculation of the power losses at load currents lower than the rated current. The correction factor, K_p, is given as a function of the RMS load current, I_b, in % of the rated current.

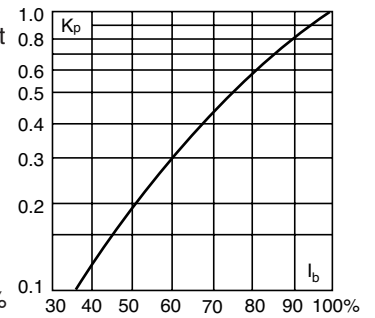

Features and Benefits

- Excellent DC performance
- Low arc voltage and low energy let-through (I²t)
- Low watts loss
- Superior cycling capability

Typical Applications

- DC Common bus
- DC Drives
- Power converters/rectifiers
- Reduced voltage starters

For Other Voltage Ratings in This Body Style

- See pages 152 (690V/700V) and 176 (1000V)

Square Body Flush End Contact — 1250V/1300V (IEC/UL): 50-1400A

Catalog Numbers

Catalog Numbers					Electrical Characteristics					
-BKN/75 Type K Indicator for Micro	-BKN/80 Type K Indicator for Micro	-BKN/90 Type K Indicator for Micro	-GKN/75 Type K Indicator for Micro	-GKN/90 Type K Indicator for Micro	Size	Rated Current RMS- Amps	I ² t (A ² Sec)			Watts Loss
							Pre-arc	Clearing at 1000V	Clearing at 1250V	
170M3388	170M3438		170M3488		1*	50	135	815	1100	15
170M3389	170M3439		170M3489			63	215	1300	1750	20
170M3390	170M3440		170M3490			80	420	2500	3350	25
170M3391	170M3441		170M3491			100	750	4450	5950	30
170M3392	170M3442		170M3492			125	1450	9000	11500	35
170M3393	170M3443		170M3493			160	2600	16000	21000	40
170M3394	170M3444		170M3494			200	5150	31000	41000	45
170M3395	170M3445		170M3495			250	9200	54500	73000	55
170M3396	170M3446		170M3496			315	18500	115000	150000	60
170M3397	170M3447		170M3497			350	27000	165000	220000	65
	170M3448				400	53000	265000	335000	70	
170M4388	170M4438		170M4488		1	160	1900	11500	15500	45
170M4389	170M4439		170M4489			200	3800	22500	30000	50
170M4390	170M4440		170M4490			250	7750	46000	61500	60
170M4391	170M4441		170M4491			315	15000	90000	120000	65
170M4392	170M4442		170M4492			350	20000	125000	165000	70
170M4393	170M4443		170M4493			400	29500	175000	235000	75
170M4394	170M4444		170M4494			450	42000	250000	335000	80
170M4395†	170M4445		170M4495†			500	69500	340000	435000	85
170M4396‡	170M4446		170M4496‡			550	95000	465000	590000	95
170M4397‡	170M4447‡		170M4497‡			630	130000	660000		100
170M5388	170M5438		170M5588		2	250	6500	38500	51500	65
170M5389	170M5439		170M5589			280	9350	55500	74500	70
170M5390	170M5440		170M5590			315	13000	77500	105000	75
170M5391	170M5441		170M5591			350	16500	97500	135000	80
170M5392	170M5442		170M5592			400	23000	140000	180000	85
170M5393	170M5443		170M5593			450	34000	205000	270000	90
170M5394	170M5444	170M5494	170M5594	170M5644		500	48000	285000	380000	95
170M5395	170M5445	170M5495	170M5595	170M5645		550	62000	370000	495000	100
170M5396†	170M5446	170M5496	170M5596†	170M5646		630	115000	575000	730000	110
170M5397‡	170M5447‡	170M5497	170M5597‡	170M5647		700	160000	795000	1050000	115
170M5398‡	170M5448‡	170M5498	170M5598‡	170M5648	800	245000	1200000	1550000	120	
		170M5499		170M5649	900†	360000	1750000		125	
		170M5500		170M5650	1000†	480000	2350000		135	
170M6338	170M6538		170M6588		3	315	9500	58000	77500	85
170M6339	170M6539		170M6589			350	13500	81500	110000	90
170M6340	170M6540		170M6590			400	19500	120000	160000	95
170M6341	170M6541		170M6591			450	31000	185000	245000	100
170M6342	170M6542		170M6592			500	39000	235000	310000	105
170M6343	170M6543		170M6593			550	55000	325000	435000	110
170M6344	170M6544	170M6494	170M6594	170M6644		630	83500	495000	665000	115
170M6345	170M6545	170M6495	170M6595	170M6645		700	115000	705000	940000	120
170M6346†	170M6546	170M6496¥	170M6596†	170M6646¥		800	205000	995000	1300000	125
170M6347‡	170M6547‡	170M6497¥	170M6597‡	170M6647¥		900	305000	1500000	1900000	130
170M6348‡	170M6548‡	170M6498¥	170M6598‡	170M6648¥	1000	450000	2150000	2750000	135	
170M6349‡	170M6549‡	170M6499¥	170M6599‡	170M6649¥	1100	575000	2800000	3600000	140	
		170M6500		170M6650	1250†	810000	3950000		145	
		170M6501		170M6651	1400†	1250000	6000000		150	

†Rated voltage (IEC) 1100V.

‡Rated voltage (IEC) 1000V.

¥Rated voltage (IEC) 1250V.

• Watts loss provided at rated current.

• Microswitch indicator ordered separately. See accessories on pages 212-213.

• For fuse curves see pages 193 and 194.

Square Body US Style — 1250V/1300V (IEC/UL): 50-1400A

1250V/1300V (IEC/UL) 50-1400A

Specifications

Description: Square body US style high speed fuses.

Dimensions: See dimensions illustration.

Ratings:

Volts: — 1250Vac (IEC)
— 1300Vac (UL)

Amps: — 50-1400A

IR: — 100kA RMS Sym.

Agency Information: CE, Designed and tested to IEC 60269: Part 4. UL Recognized E125085.JFHR2, CSA Certified: Class 53787, File 1422-30.



Electrical Characteristics

Total Clearing I²t

The total clearing I²t at rated voltage and at power factor of 15% are given in the electrical characteristics. For other voltages, the clearing I²t is found by multiplying by correction factor, K, given as a function of applied working voltage, E_g, (rms).

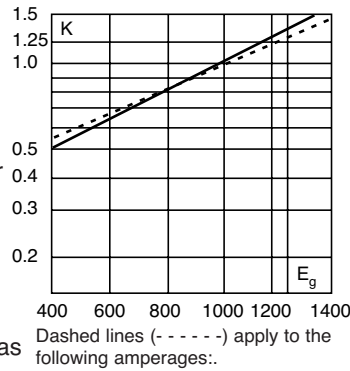

Dimensions - mm

Type -FU/115, -FKE/115

Size	B	C1	C2	D	E	H	I
1*	156	130	101	59	45	20	10
1	160	127	102	69	53	25	14
2	160	127	102	77	61	25	14
3	159	128	101	92	76	36	16

1mm = 0.0394" / 1" = 25.4mm

Arc Voltage

This curve gives the peak arc voltage, U_L, which may appear across the fuse during its operation as a function of the applied working voltage, E_g, (rms) at a power factor of 15%.

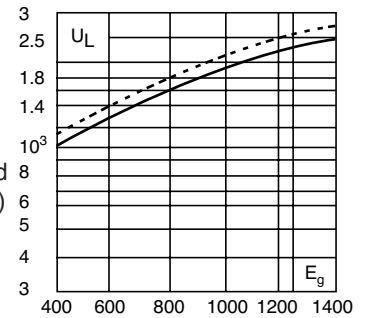

Power Losses

Watts loss at rated current is given in the electrical characteristics. The curve allows the calculation of the power losses at load currents lower than the rated current. The correction factor, K_p, is given as a function of the RMS load current, I_b, in % of the rated current.

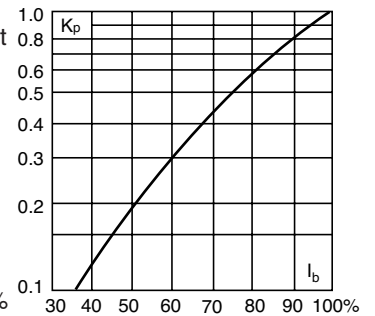

Features and Benefits

- Excellent DC performance
- Low arc voltage and low energy let-through (I²t)
- Low watts loss
- Superior cycling capability

Typical Applications

- DC Common bus
- DC Drives
- Power converters/rectifiers
- Reduced voltage starters

For Other Voltage Ratings in This Body Style

- See pages 153 (690V/700V) and 178 (1000V)

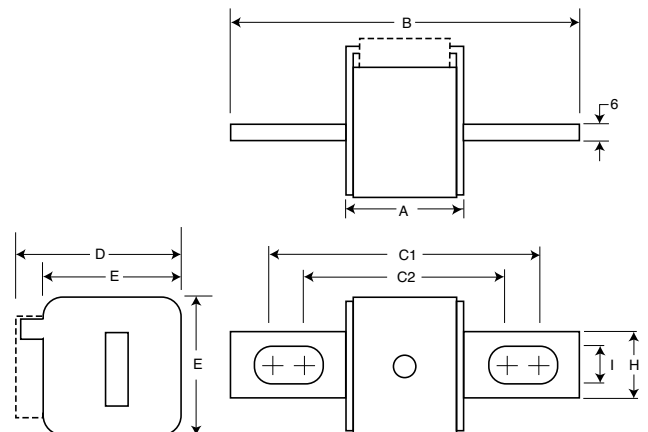

Square Body US Style — 1250V/1300V (IEC/UL): 50-1400A

Catalog Numbers

Catalog Numbers		Size	Electrical Characteristics				
-FU/115 Without Indicator	-FKE/115 Type K Indicator for Micro		Rated Current RMS-Amps	I ² t (A ² Sec)			Watts Loss
				Pre-arc	Clearing at 1000V	Clearing at 1250V	
170M3688	170M3738	1*	50	135	815	1100	15
170M3689	170M3739		63	215	1300	1750	20
170M3690	170M3740		80	420	2500	3350	25
170M3691	170M3741		100	750	4450	5950	30
170M3692	170M3742		125	1450	9000	11500	35
170M3693	170M3743		160	2600	16000	21000	40
170M3694	170M3744		200	5150	31000	41000	45
170M3695	170M3745		250	9200	54500	73000	55
170M3696	170M3746		315	18500	115000	150000	60
170M3697	170M3747		350	27000	165000	220000	65
170M4688	170M4738	1	160	1900	11500	15500	45
170M4689	170M4739		200	3800	22500	30000	50
170M4690	170M4740		250	7750	46000	61500	60
170M4691	170M4741		315	15000	90000	120000	65
170M4692	170M4742		350	20000	125000	165000	70
170M4693	170M4743		400	29500	175000	235000	75
170M4694	170M4744		450	42000	250000	335000	80
170M4695	170M4745		500†	69500	340000		85
170M4696	170M4746		550‡	95000	465000		95
170M4697	170M4747		630‡	130000	660000		100
170M5688	170M5738	2	250	6500	38500	51500	65
170M5689	170M5739		280	9350	55500	74500	70
170M5690	170M5740		315	13000	77500	105000	75
170M5691	170M5741		350	16500	97500	135000	80
170M5692	170M5742		400	23000	140000	180000	85
170M5693	170M5743		450	34000	205000	270000	90
170M5694	170M5744		500	48000	285000	380000	95
170M5695	170M5745		550	62000	370000	495000	100
170M5696	170M5746		630	115000	575000	730000	110
170M5697	170M5747		700‡	160000	795000		115
170M5698	170M5748	800‡	245000	1200000		120	
170M5699	170M5749	900‡	360000	1750000		125	
170M5700	170M5750	1000‡	480000	2350000		135	
170M6688	170M6738	3	315	9500	58000	77500	185
170M6689	170M6739		350	13500	81500	110000	90
170M6690	170M6740		400	19500	120000	160000	95
170M6691	170M6741		450	31000	185000	245000	100
170M6692	170M6742		500	39000	235000	310000	105
170M6693	170M6743		550	55000	325000	435000	110
170M6694	170M6744		630	83500	495000	665000	115
170M6695	170M6745		700	115000	705000	940000	120
170M6696	170M6746		800	205000	995000	1300000	125
170M6697	170M6747		900	305000	1500000	1900000	130
170M6698†	170M6748†	1000¥	450000	2150000		135	
170M6699†	170M6749†	1100¥	575000	2800000		140	
170M6700‡	170M6750‡	1250¥	810000	3950000		145	
170M6701‡	170M6751‡	1400¥	1250000	6000000		150	

†Rated voltage (IEC) 1100.

‡Rated voltage (IEC) 1000V.

¥ UL Recognition at 1000V.

• Watts loss provided at rated current.

• Microswitch indicator ordered separately. See accessories on pages 212-213.

• For fuse curves see pages 193 and 194.

Square Body Size 1*, 1 — 1250V/1300V (IEC/UL): 50-1400A

Size 1* — 50-400A:1250V
Time-Current Curve

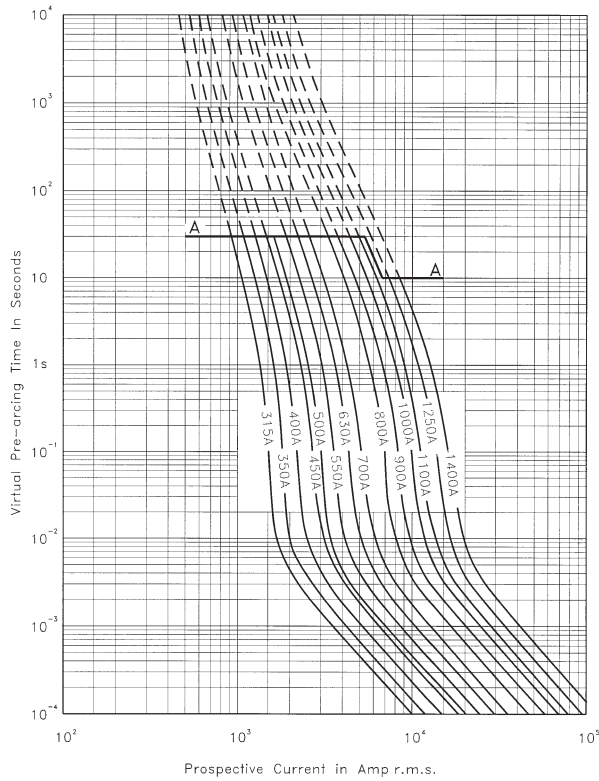

Size 1 — 160-630A: 1250V
Time-Current Curve

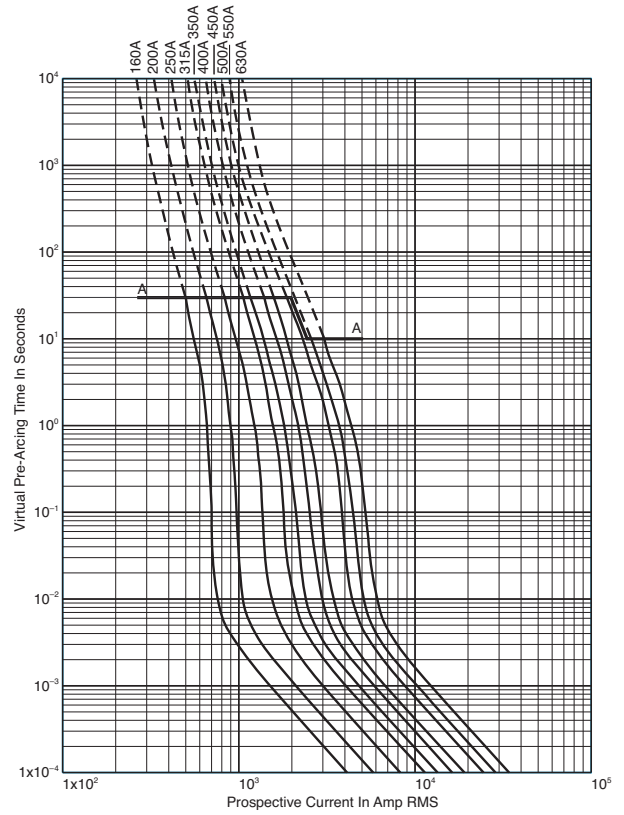

Peak Let-Through Curve

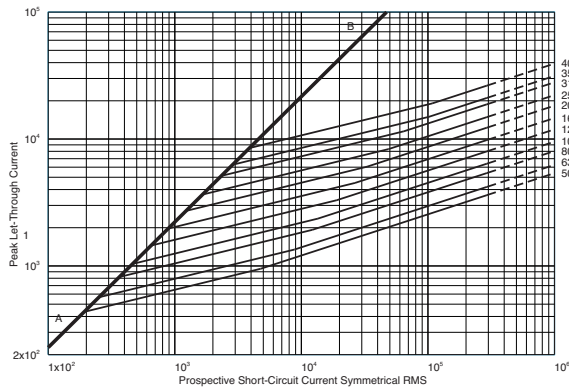

Peak Let-Through Curve

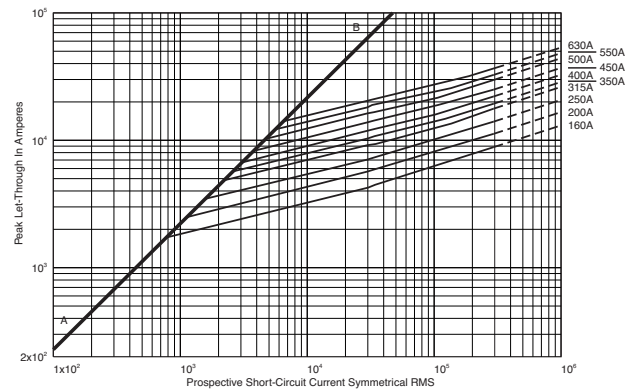

630A fuse is derated to 1100V (IEC).

Square Body Size 2, 3 — 1250V/1300V (IEC/UL): 50-1400A

Size 2 — 250-1000A: 1250V
Time-Current Curve

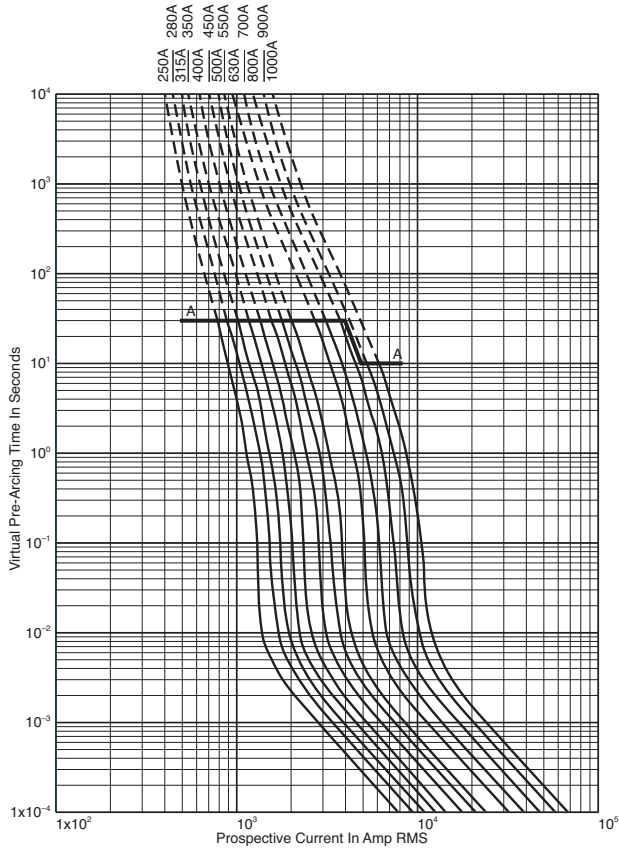

Size 3 — 315-1400A: 1250V
Time-Current Curve

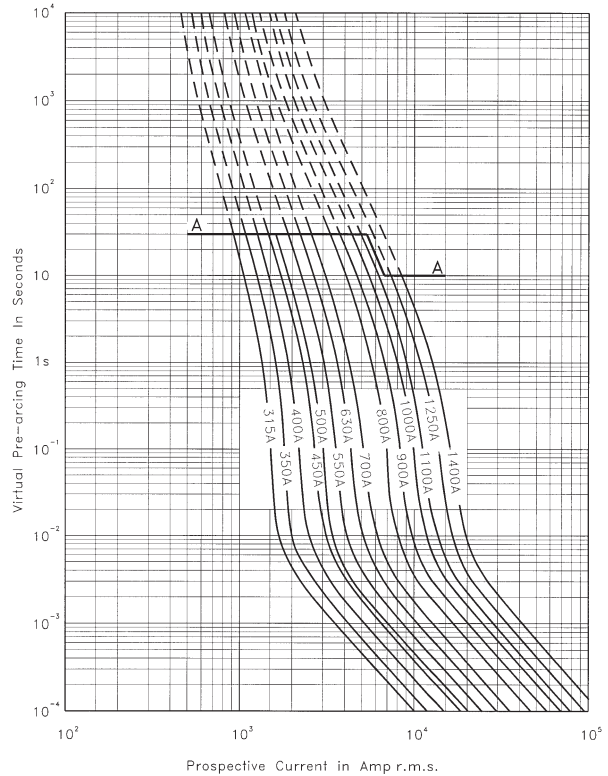

Peak Let-Through Curve

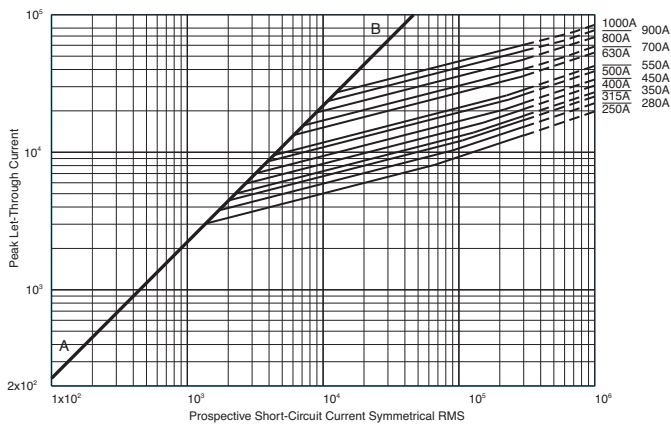

900-1000A fuses are derated to 1100V (IEC).

Peak Let-Through Curve

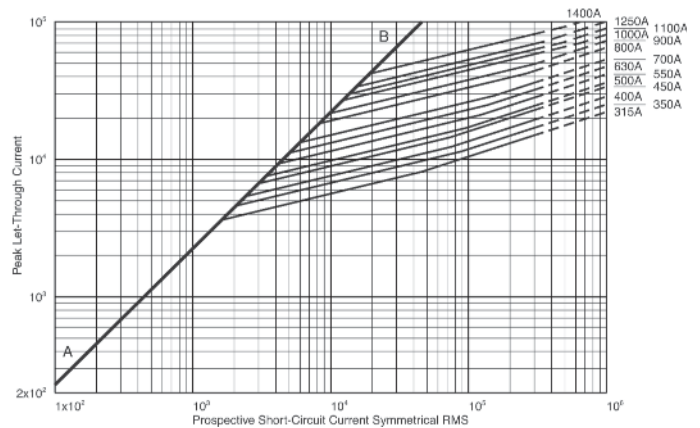

1250-1400A fuses are derated to 1100V (IEC).

Square Body Flush End Contact Size 4 — 1250V (IEC): 1400-2500A

1250V (IEC) 1400-2500A

Specifications

Description: High speed square body fuses, for the protection of the power rectifier section of the equipment.

Dimensions: See dimensions illustration.

Ratings:

Volts: — 1250Vac (IEC)

Amps: — 1400-2500A

IR: — 125kA RMS Sym.

Agency Information: CE, Designed and tested to IEC 60269: Part 4. UL Recognized E125085.JFHR2.

Electrical

Characteristics

Total clearing I^2t

The total clearing I^2t at rated voltage and at power factor of 15% are given in the electrical characteristics. For other voltages, the clearing I^2t is found by multiplying by correction factor, K, given as a function of applied working voltage, E_g , (rms).

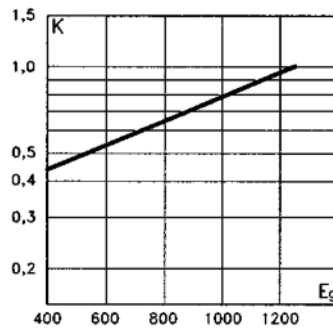

Arc Voltage

This curve gives the peak arc voltage, U_L , which may appear across the fuse during its operation as a function of the applied working voltage E_g , (rms) at a power factor of 15%.

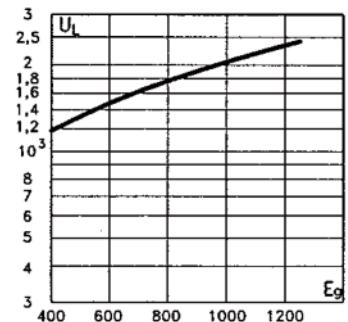

Power Losses

Watts loss at rated current is given in the electrical characteristics. The curve allows the calculation of the power losses at load currents lower than the rated current. The correction factor, K_p , is given as a function of the RMS load current, I_b , in % of the rated current.

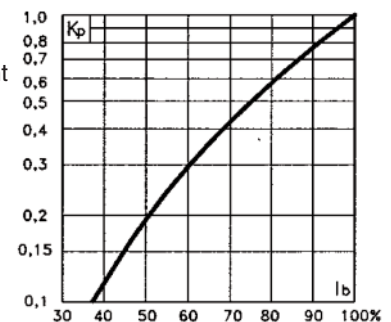

Features and Benefits

- Excellent DC performance
- Low arc voltage and low energy let-through (I^2t)
- Low watts loss
- Superior cycling capability

Typical Applications

- DC Common bus
- DC Drives
- Power converters/rectifiers
- Reduced voltage starters

For Other Voltage Ratings in This Body Style

- See pages 163 (690V/700V) and 182 (1000V)

Catalog Numbers

Fuse Size	Catalog Number		Electrical Characteristics				
	-BKN/105 Type K Indicator	-SBKN/105 Type K Indicator	Rated Voltage (V)	Rated Current RMS-Amp	I^2t (A ² Sec)		Watt Loss (W)
					Pre-arc	Clearing at 1250V	
4	170M7217	170M7512	1250	1400	800000	5000000	195
	170M7597	170M7510		1500	1000000	6200000	200
	170M7676	170M7511		1700	1400000	8700000	220
	170M7532	170M7976		1800	1700000	11000000	225
	170M7633	170M7513		2000	2300000	14500000	235
	170M7592	170M7546		2200	3100000	19500000	245
	170M7107	170M7516		2400	4000000	25000000	255
	170M7595	170M7978		2500	4500000	28000000	260

Data Sheet: 170K6640 , 170K6642

Square Body Flush End Contact Size 4 — 1250V (IEC): 1400-2500A

Dimensions - mm

Type 4BKN 105

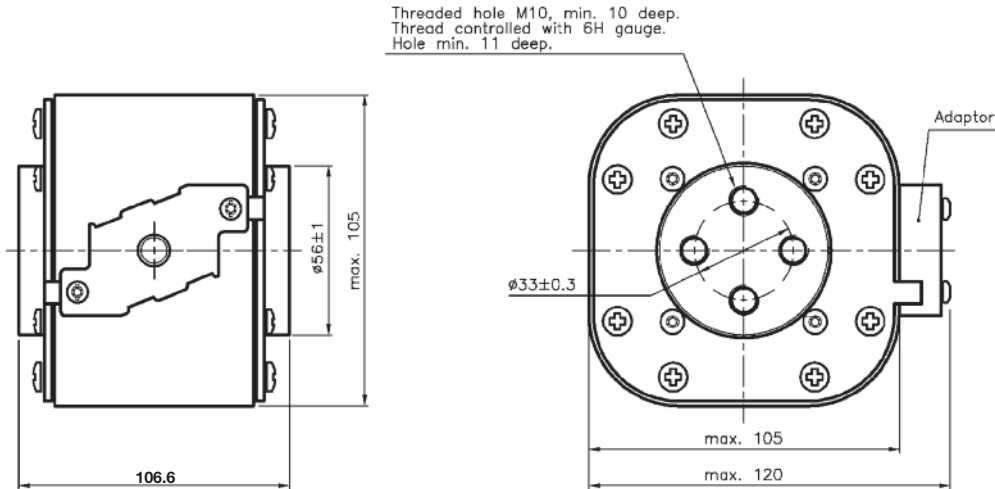

Type 4SBKN 105

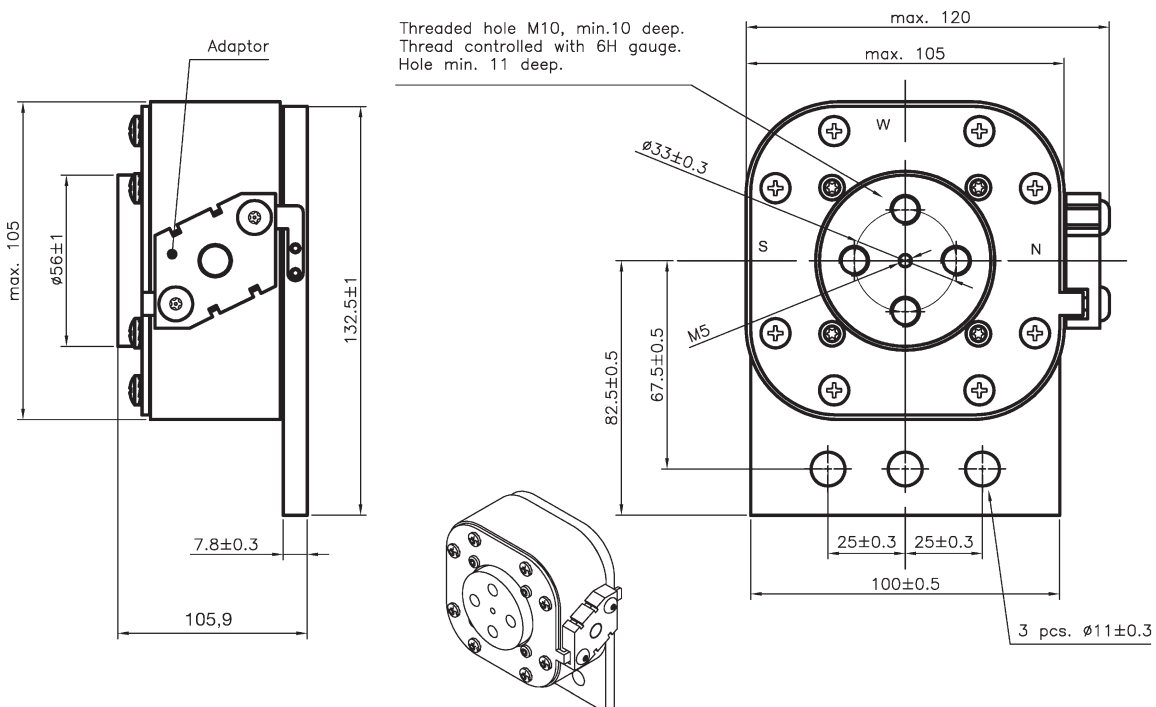

Square Body Flush End Contact Size 4 — 1250V (IEC): 1400-2500A

Size 4 — 1400-2400A: 1250V
Time-Current Curve

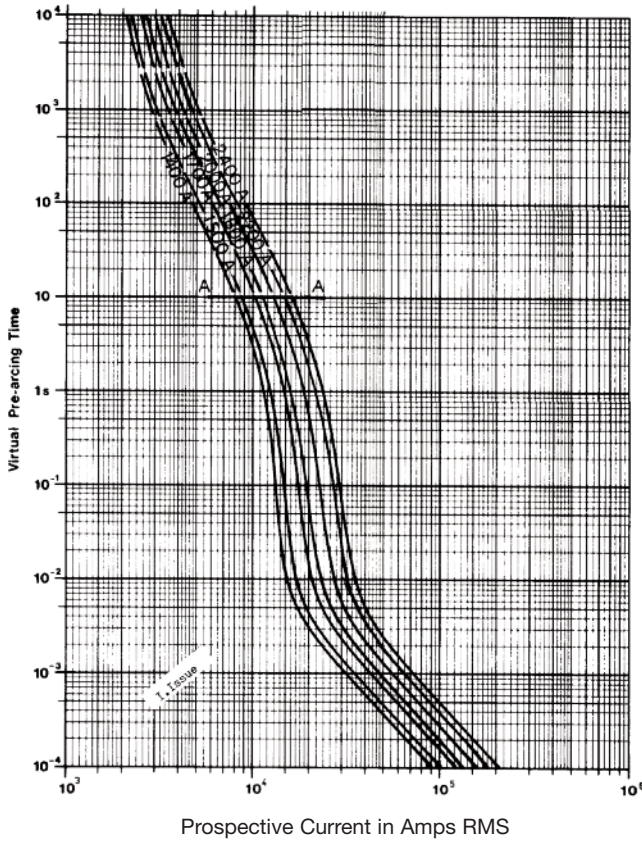

Size 4 — 2300-2500A: 1250V
Time-Current Curve

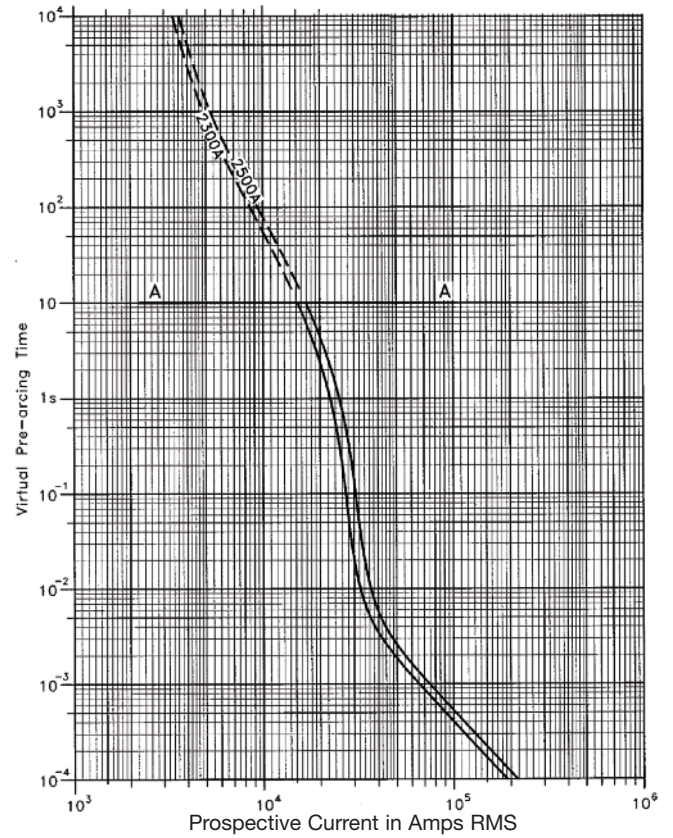

Peak Let-Through Curve

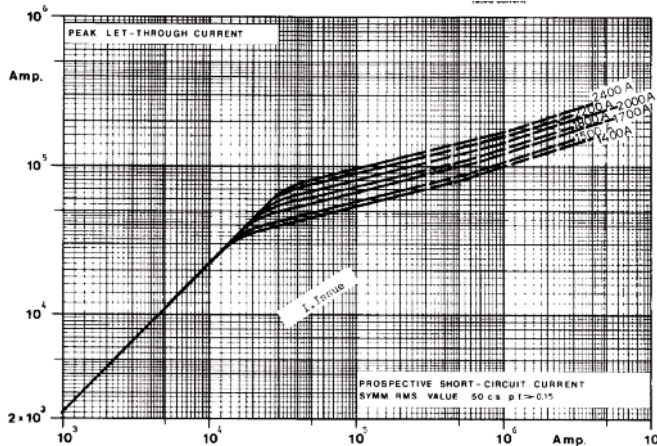

Peak Let-Through Curve

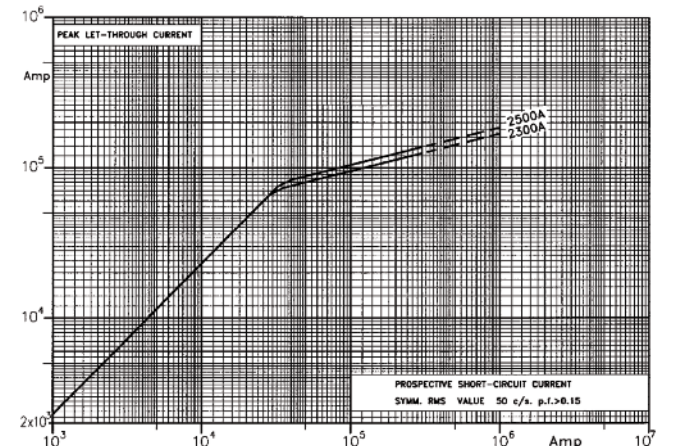

Data Sheet: Available upon request

Data Sheet: Available upon request

Square Body Flush End Contact Size 23— 1250V (IEC/UL): 630-2800A

1250V (IEC) 630-2800A

Specifications

Description: High speed square body fuses, for the protection of the power rectifier section of the equipment.

Dimensions: See dimensions illustration.

Ratings:

Volts: — 1250Vac (IEC)

Amps: — 630-2800A

IR: — 125kA RMS Sym.

Agency Information: CE, Designed and tested to IEC 60269: Part 4. UL Recognized.

Electrical Characteristics

Total clearing I²t

The total clearing I²t at rated voltage and at power factor of 15% are given in the electrical characteristics. For other voltages, the clearing I²t is found by multiplying by correction factor, K, given as a function of applied working voltage, E_g, (rms).

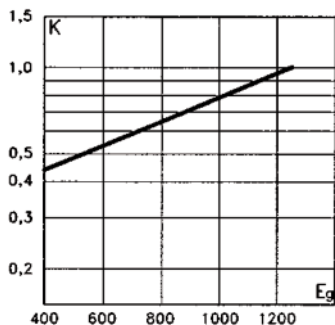

Arc Voltage

This curve gives the peak arc voltage, U_L, which may appear across the fuse during its operation as a function of the applied working voltage E_g, (rms) at a power factor of 15%.

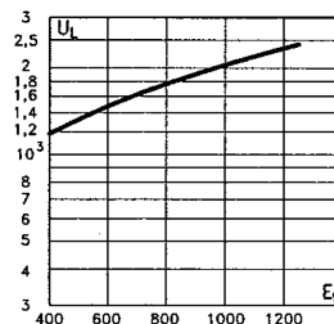

Power Losses

Watts loss at rated current is given in the electrical characteristics. The curve allows the calculation of the power losses at load currents lower than the rated current. The correction factor, K_p, is given as a function of the RMS load current, I_b, in % of the rated current.

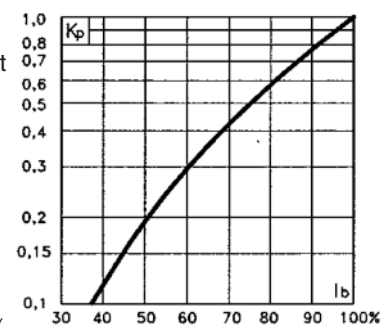

Features and Benefits

- Excellent DC performance
- Low arc voltage and low energy let-through (I²t)
- Low watts loss
- Superior cycling capability

Typical Applications

- DC Common bus
- DC Drives
- Power converters/rectifiers
- Reduced voltage starters

For Other Voltage Ratings in This Body Style

- See pages 165 (660V) and 185 (1000V)

Catalog Numbers

Fuse Size	Catalog Number						Electrical Characteristics					
	-BU/75 without Indicator	-BKE/75 Type K Indicator	-BKN/75 Type K Indicator	-BU/80 without Indicator	-BKE/80 Type K Indicator	-BKN/80 Type K Indicator	Rated Voltage (V)	Rated Current RMS-Amp	I ² t (A ² Sec)		Watts Loss (W)	
	Pre-arc		Clearing at 1250V									
23	170M6775	170M6795	170M6785				1250	630	38000	310000	170	
	170M6776	170M6796	170M6786					700	54000	440000	180	
	170M6777	170M6797	170M6787					800	78000	640000	190	
	170M6805	170M6807	170M6806					900	120000	980000	200	
	170M6778	170M6798	170M6788					1000	155000	1250000	210	
	170M6779	170M6799	170M6789					1100	220000	1750000	220	
	170M6780	170M6800	170M6790					1250	330000	2700000	230	
	170M6781	170M6801	170M6791					1400	460000	3800000	240	
	170M6782	170M6802	170M6792					1600	820000	5200000	250	
	170M6783	170M6803	170M6793					1800	1200000	7600000	260	
				170M6784	170M6804	170M6794		2000	1800000	11000000	270	
				170M6815	170M6833	170M6827		2200	2300000	14500000	280	
				170M6816	170M6834	170M6828		2500	3200000	†16000000	290	
				170M6817	170M6835	170M6829		2800	5000000	†24000000	300	
								1100				

† A²s @ 1000V
Data Sheet: 170K6638

Square Body Flush End Contact Size 23— 1250V (IEC/UL): 630-2800A

Dimensions - mm

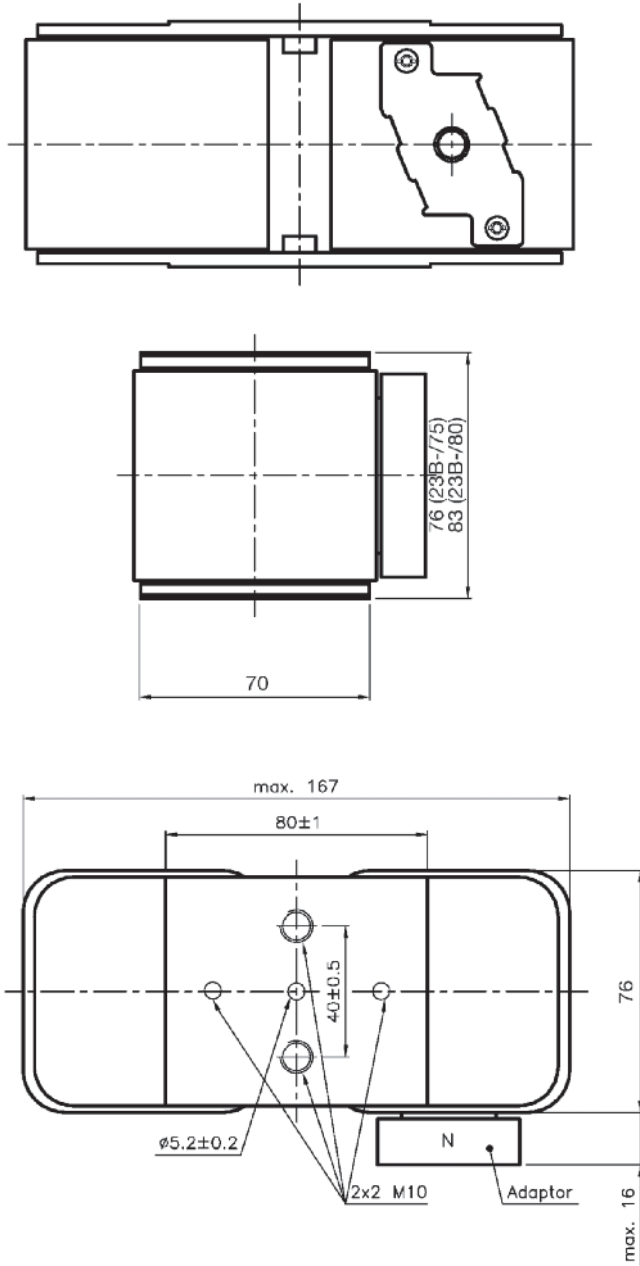

Size 23 — 630-2800A: 1250V
Time-Current Curve

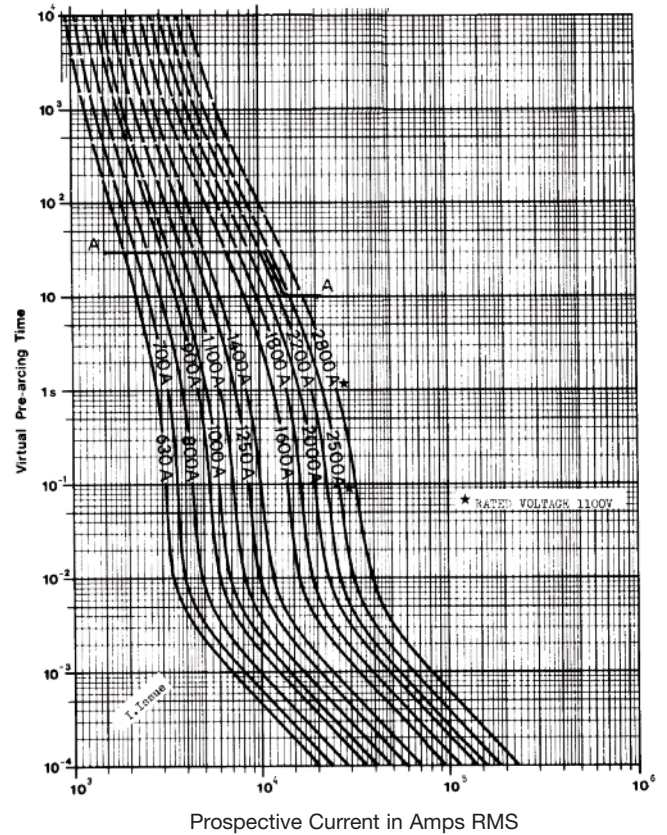

Peak Let-Through Curve

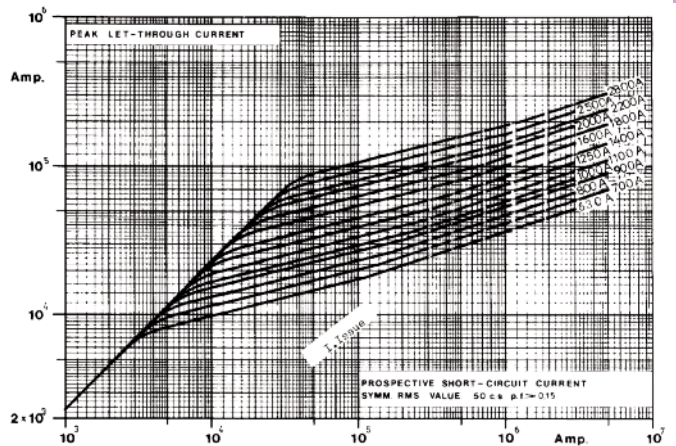

High Speed
Fuses

Square Body Flush End Contact Size 5— 1000V-2000V: 1800-5000A

1000V (IEC) 1800-5000A

Specifications

Description: High speed square body fuses, for the protection or isolation for components such as diodes, silicon controlled rectifiers (SCRs), Gate torn-Off Thyristors (GTOs) and IGBTs.

Dimensions: See dimensions illustration.

Ratings:

Volts: — 1000-2000Vac (IEC)

Amps: — 1800-5000A

IR: — 300kA RMS Sym. estimated, 197kA tested

Agency Information: Consult Bussmann.
bulehighspeedtechnical@cooperindustries.com

Features and Benefits

- Excellent DC performance
- Low arc voltage and low energy let-through (I²t)
- Low watts loss
- Superior cycling capability

Typical Applications

- AC and DC drives
- High power converters/rectifiers



Dimensions - mm (in)

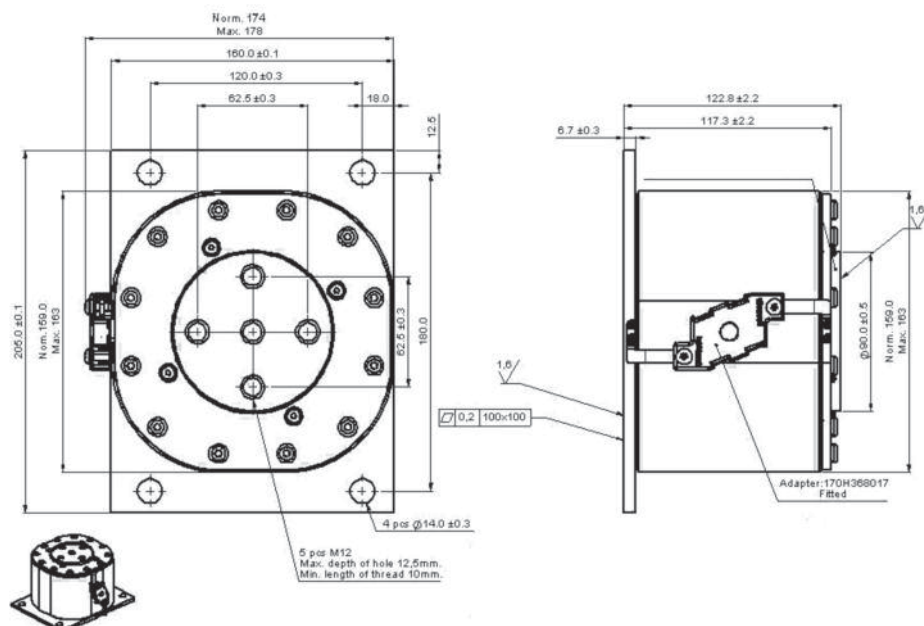

This dimension drawing is an example of the range of size 5 fuses available.

Contact Bussmann for available parts and technical information.

Square Body DC Fuses — 750Vdc: 63-500A

750Vdc 63-500A

Specifications

Description: High speed fuses, for the protection of DC circuits in equipment.

Dimensions: See dimensions illustration.

Ratings:

Volts: — 750Vdc

Amps: — 63-500A

IR: — 750Vdc IR: 100kA, L/R = 100 ms.
— 1000Vdc IR: 100kA, L/R = 40 ms

Agency Information: Consult Cooper Bussmann.

Electrical Characteristics

Arc Voltage

This curve gives the peak arc voltage, U_L , which may appear across the fuse during its operation as a function of the applied working voltage E_g .

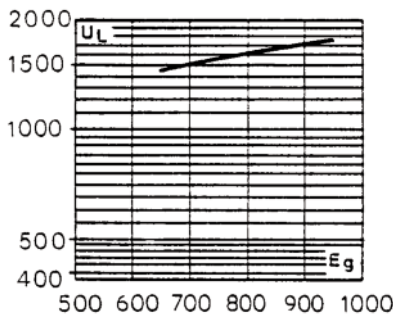

Power Losses

Watts loss at rated current is given in the electrical characteristics. The curve allows the calculation of the power losses at load currents lower than the rated current. The correction factor, K_p , is given as a function of the RMS load current, I_b , in % of the rated current.

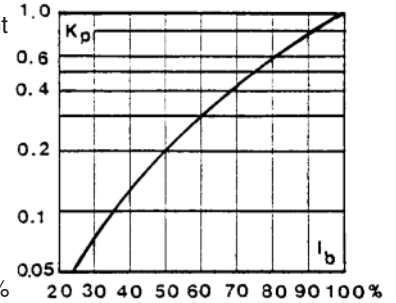

Features and Benefits

- Excellent DC performance
- Low arc voltage and low energy let-through (I^2t)
- Low watts loss
- Superior cycling capability

Typical Applications

- DC common bus
- DC drives
- Power converters/rectifiers
- Reduced voltage starters

Catalog Numbers

Fuse Size	Catalog Numbers		Electrical Characteristics		
	-BK/130	-EK/-	Rated Voltage (Vdc)	Rated Current RMS-Amp	Watt Loss (W)
1*	170E3577	170E3583	750	63	10.0
	170E3578	170E3584		80	13.0
	170E3579	170E3585		100	16.0
	170E3580	170E3586		125	21.0
	170E3581	170E3587		160	26.0
1	170E5417	170E5420		200	37.0
	170E5418	170E5421		250	46.0
2	170E8335	170E8345		250	47.0
	170E8336	170E8346		315	57.0
	170E8337	170E8347		400	73.0
3	170E9681	170E9685		500	91.0

Data Sheet: Size 1*: 170K3620
Size 1: 170K3622
Size 2: 170K3624
Size 3: 170K3626
Microswitch: 170H0069, 170H3027 (gold)

Square Body DC Fuses — 750Vdc: 63-500A

Dimensions - mm

Type -BK/130

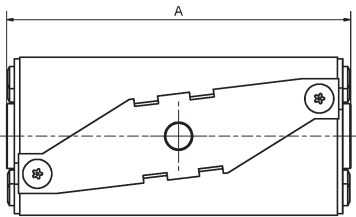
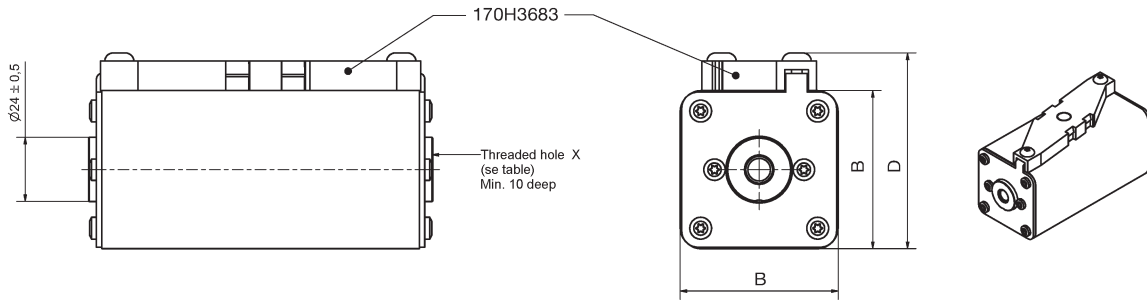

Size/Type	A	B	D
1* BK/130	129	43	61
1 BK/130	130	51	69
2 BK/130	130	59	77
3 BK/130	131	74	90

Type -EK/ -

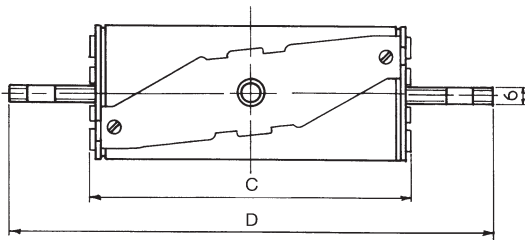
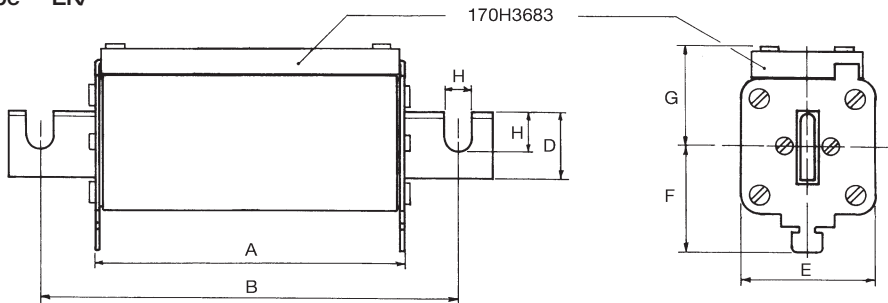

Size/Type	A	B	C	D	E	F	G	H	I	J
1* EK/155	124	156	129	180	43	36	41	9	9	18
1 EK/165	124	166	129	191	51	37	41	11	14	25
2 EK/170	124	170	129	205	59	42	48	13	21	30
3 EK/170	125	170	130	206	74	51	56	13	20	36

Square Body DC Fuses — 750Vdc: 63-500A

Square Body DC Fuse — 63-160A: 750V
Time-Current Curve

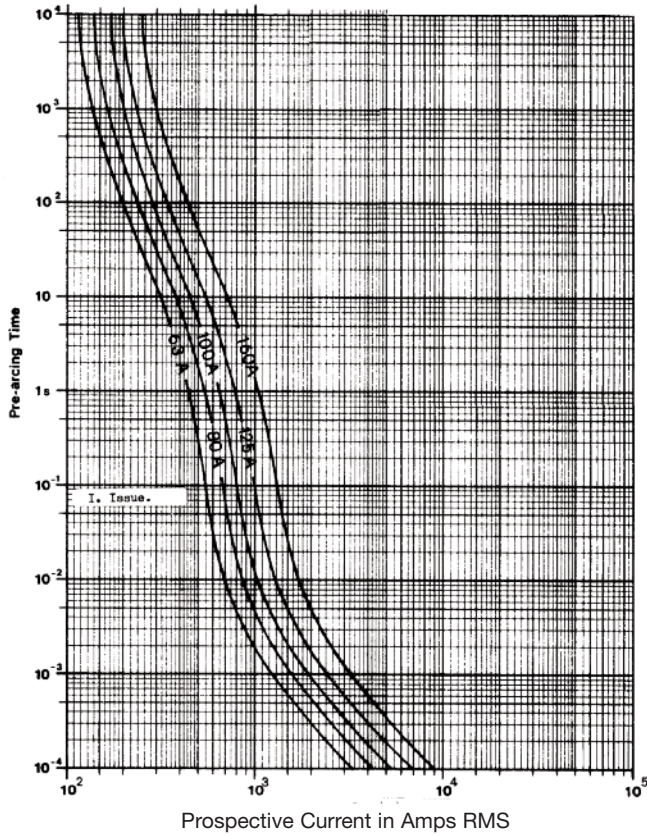

Square Body DC Fuse — 200-250A: 750V
Time-Current Curve

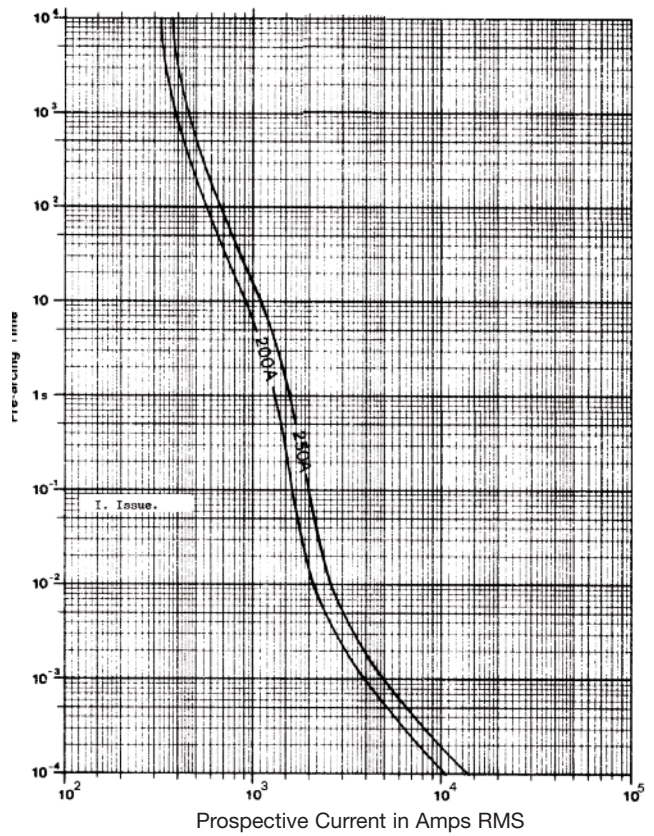

Peak Let-Through Curve

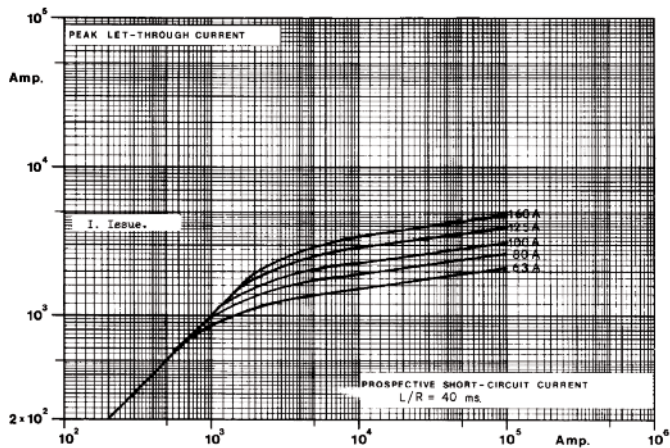

Peak Let-Through Curve

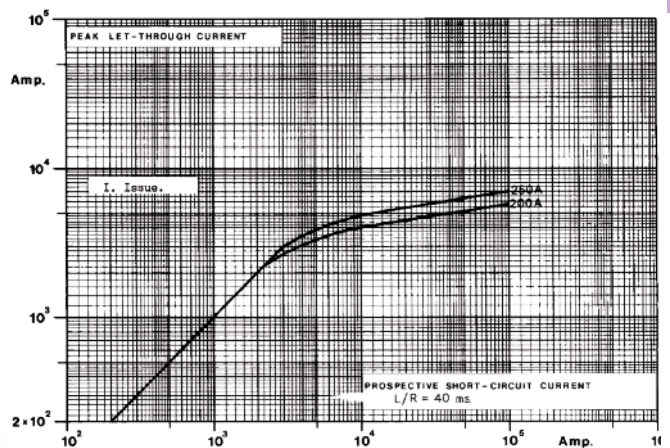

Data Sheet: Available upon request

Data Sheet: Available upon request

Square Body DC Fuses — 750Vdc: 63-500A

Square Body DC Fuse — 250-400A: 750V
Time-Current Curve

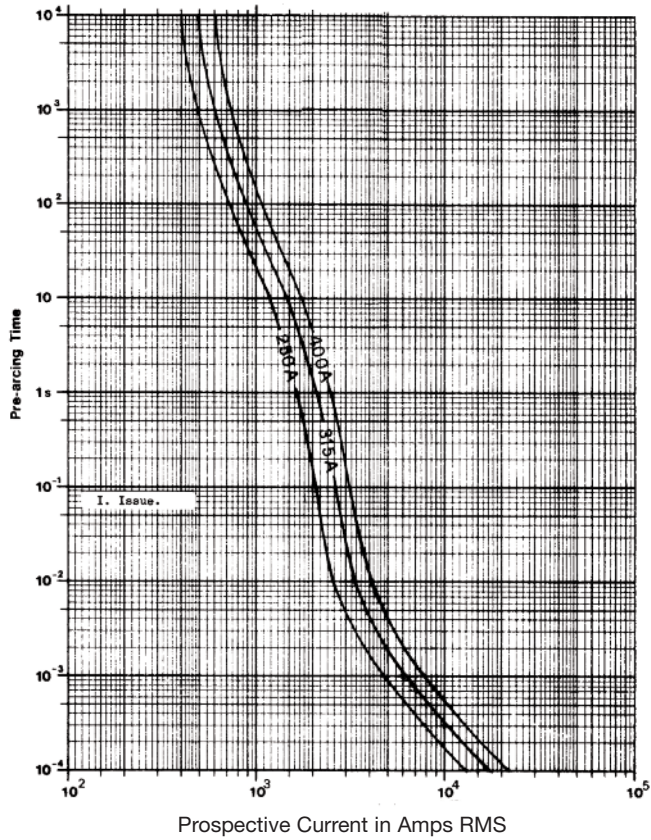

Square Body DC Fuse — 500A: 750V
Time-Current Curve

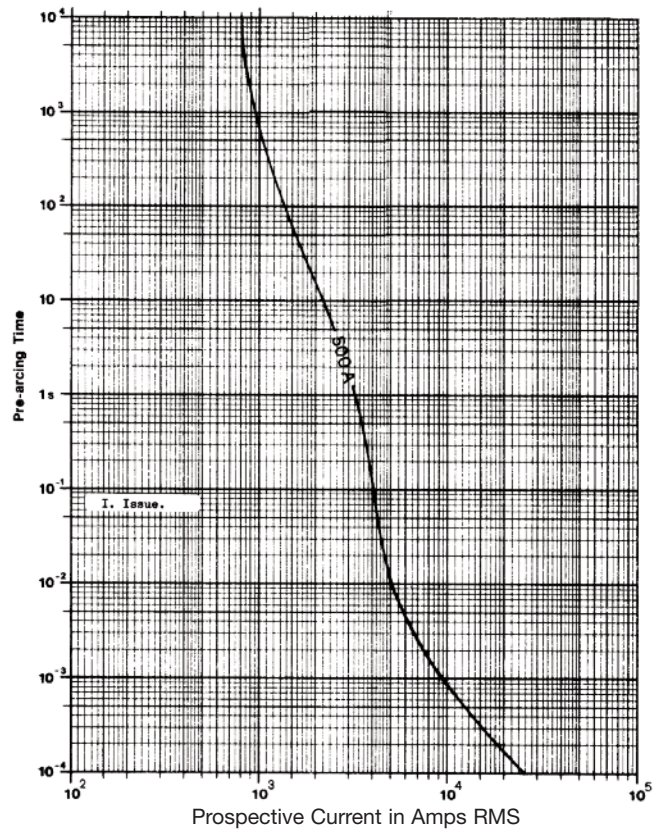

Peak Let-Through Curve

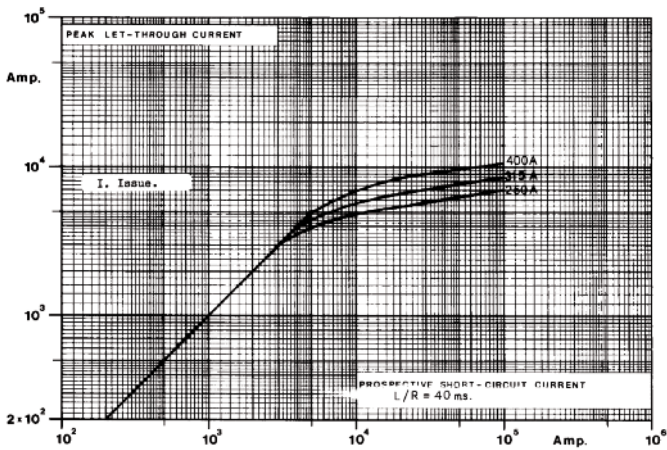

Peak Let-Through Curve

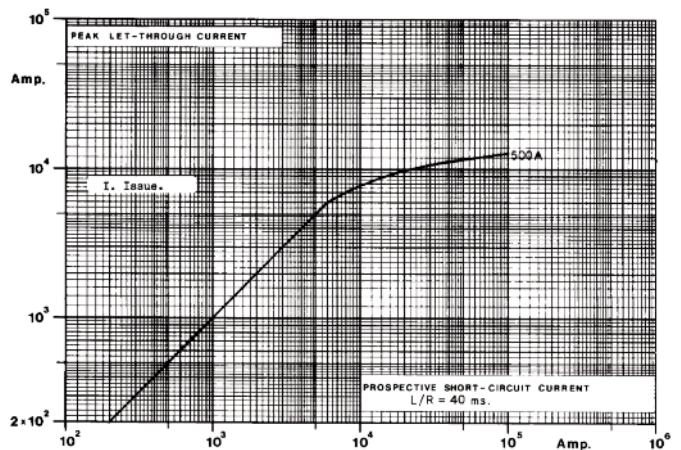

Data Sheet: Available upon request

Data Sheet: Available upon request

Square Body DC Fuses — 1200Vdc: 160-420A

1200Vdc 160-420A

Specifications

Description: High speed fuses that provide superior protection in light and heavy harsh DC traction applications as 1200Vdc and below circuits, and as DC link/power converters.

Dimensions: See dimensions illustration.

Ratings:

Volts: — 1200Vdc

Amps: — 160-420A

IR: — 1200Vdc = 100kA L/R: 15 ms.

Agency Information: Consult Cooper Bussmann.

Electrical Characteristics

Arc Voltage

This curve gives the peak arc voltage, U_L , which may appear across the fuse during its operation as a function of the applied working voltage E_g .

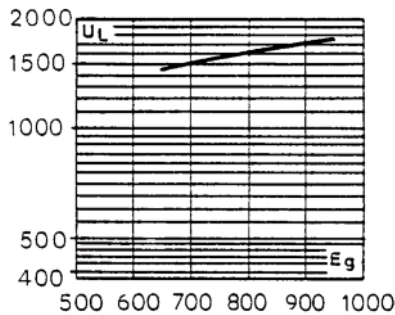

Power Losses

Watts loss at rated current is given in the electrical characteristics. The curve allows the calculation of the power losses at load currents lower than the rated current. The correction factor, K_p , is given as a function of the RMS load current, I_b , in % of the rated current.

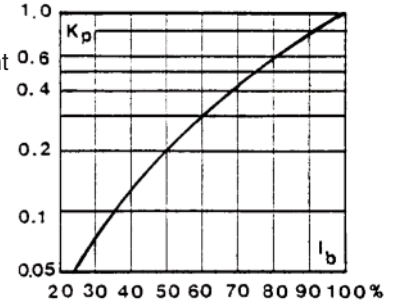

Features and Benefits

- Excellent DC performance
- Low arc voltage and low energy let-through (I^2t)
- Low watts loss
- Superior cycling capability

Typical Applications

- DC Common bus
- DC Drives
- Power converters/rectifiers
- Reduced voltage starters

Catalog Numbers

Fuse Type	Cat. Numbers -SKNB/140 Type K Indicator	Electrical Characteristics				
		Rated Voltage (Vdc)	Rated Current RMS-Amp	Max Ft (A ² Sec) @ 1000Vdc		Watts Loss (W)
				L/R = 15ms	L/R = 45ms	
2SKN / 140	170F8230	1200	160	12000	20000	75.0
	170F8231		200	20000	35000	85.0
	170F8232		250	43000	75000	94.0
	170F8233		315	87000	150000	104.0
	170F8234		400	180000	310000	120.0
	170F8235		420	215000	375000	122.0

Data Sheet: 170K5520
Microswitch: 170H0069, 170H3027 (gold)

Dimensions - mm

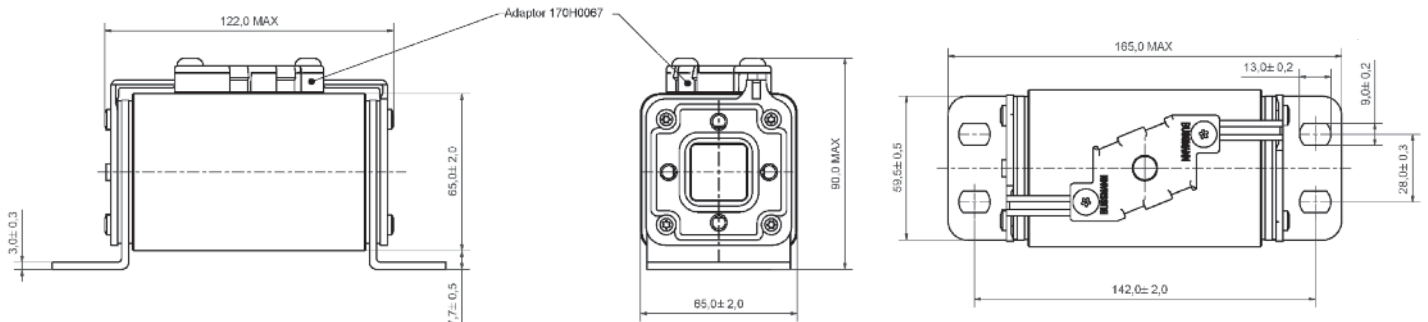

Square Body DC Fuses — 1200Vdc: 160-420A

Square Body DC Fuse — 160-420A: 1200V Time-Current Curve

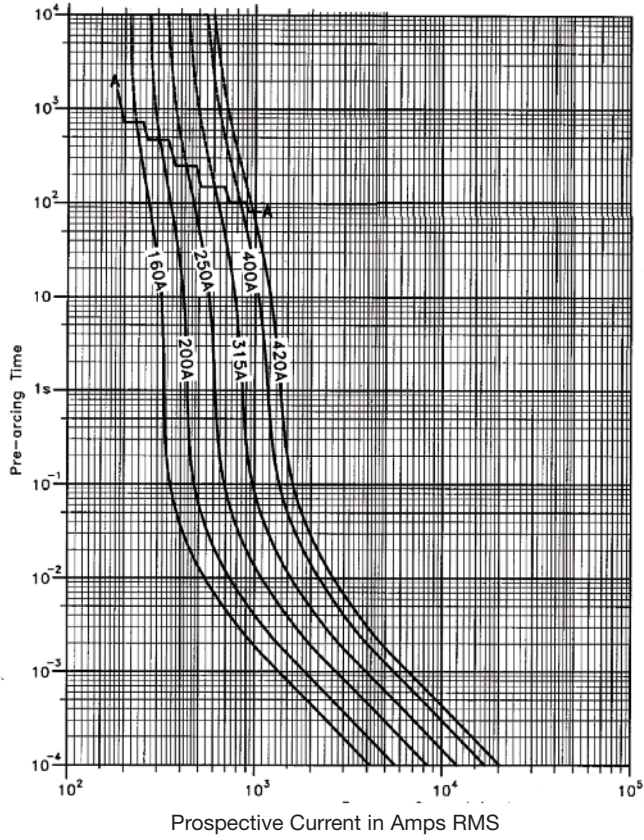

Data Sheet: Available upon request

Square Body DC fuses — 2000Vdc: 10-125A

2000Vdc 10-125A

Specifications

Description: High speed fuses for the protection of DC circuits in equipment.

Dimensions: See dimensions illustration.

Ratings:

Volts: — 1200Vdc

Amps: — 160-420A

IR: — 1200Vdc = 100kA L/R: 15 ms.

Agency Information: Consult Bussmann.



Power Losses

Watts loss at rated current is given in the electrical characteristics. The curve allows the calculation of the power losses at load currents lower than the rated current. The correction factor, K_p , is given as a function of the RMS load current, I_b , in % of the rated current.

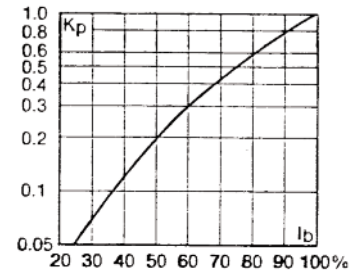

Electrical Characteristics

Arc Voltage

This curve gives the peak arc voltage, U_L , which may appear across the fuse during its operation as a function of the applied working voltage E_g .

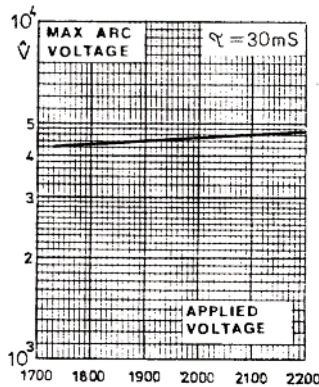

Features and Benefits

- Excellent DC performance
- Low arc voltage and low energy let-through (I^2t)
- Low watts loss
- Superior cycling capability

Typical Applications

- DC Common bus
- DC Drives
- Power converters/rectifiers
- Reduced voltage starters

Catalog Numbers

Fuse Type	Cat. Number	Electrical Characteristics		
	-SKN/246 Type K Indicator	Rated Voltage (Vdc)	Rated Current RMS-Amp	Watt Loss (W)
1*SKN/246	170E3976	2000	10	7
	170E3970		16	11
	170E3950		20	13
	170E3951		25	17
	170E3952		32	22
	170E3953		40	27
	170E3954		50	34
	170E3955		63	43
	170E3956		80	50

Fuse Type	Cat. Number	Electrical Characteristics		
	-SKN/246 Type K Indicator	Rated Voltage (Vdc)	Rated Current RMS-Amp	Watt Loss (W)
1*SKN/246	170E3937	2000	20	13
	170E3938		25	16
	170E3939		32	20
	170E3940		40	25
	170E3941		50	32
	170E3942		63	40
	170E3943		80	51
	170E3944		100	64
	170E3945		125	80

Dimensions - mm

Data Sheet: 170K4538
Microswitch: 170H0239, 170H3030 (gold)

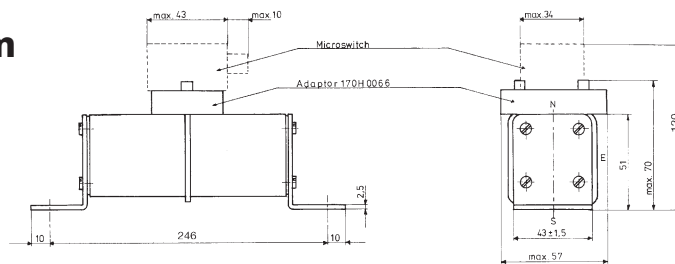

Data Sheet: 170K4900
Microswitch: 170H0239, 170H3030 (gold)

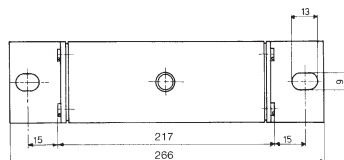

Square Body DC fuses — 2000Vdc: 10-125A

Square Body DC Fuses — 10-80A: 2000V
Time-Current Curve

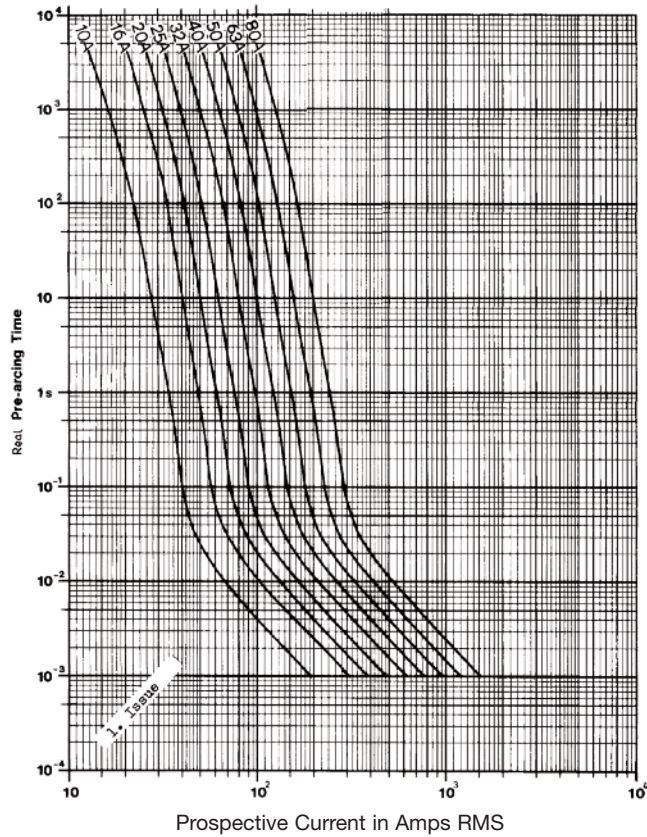

Square Body DC Fuses — 20-125A: 2000V
Time-Current Curve

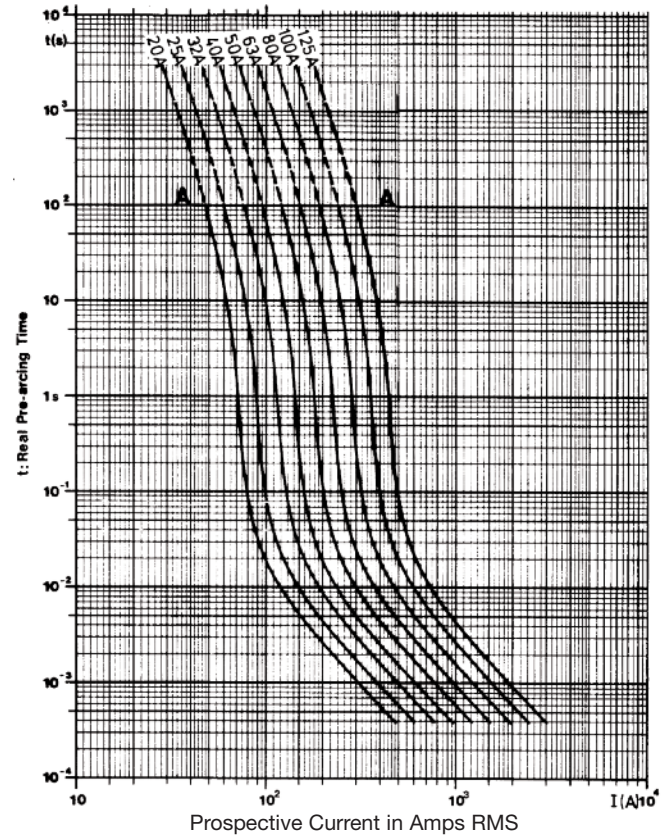

Peak Let-Through Curve

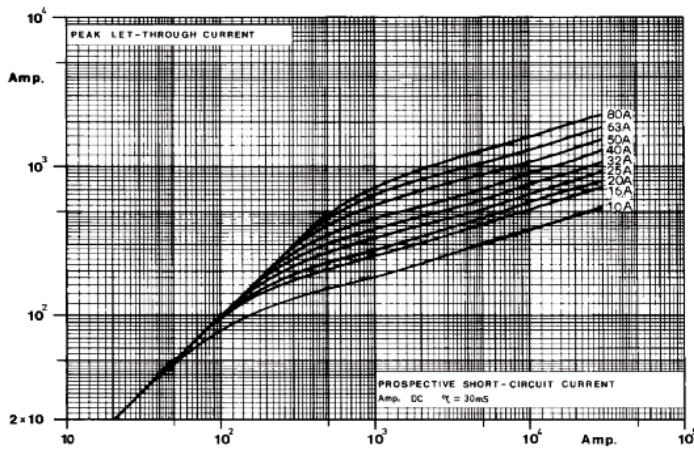

Peak Let-Through Curve

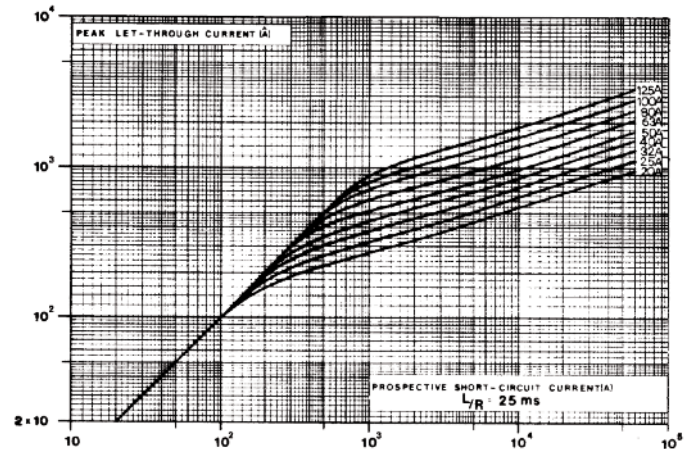

Data Sheet: Available upon request

Data Sheet: Available upon request

Square Body DC Fuses — 4000Vdc: 20-450A

4000Vdc 20-450A

Specifications

Description: High speed fuses for the protection of DC circuits in equipment.

Dimensions: See dimensions illustration.

Ratings:

Volts: — 4000Vdc

Amps: — 20-450A

IR: — 60kA L/R: 25 ms.

Agency Information: Consult Bussmann.



Electrical Characteristics

Arc Voltage

This curve gives the peak arc voltage, U_L , which may appear across the fuse during its operation as a function of the applied working voltage E_g .

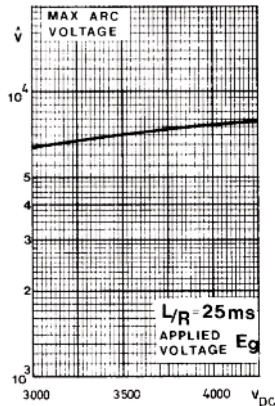

Power Losses

Watts loss at rated current is given in the electrical characteristics. The curve allows the calculation of the power losses at load currents lower than the rated current. The correction factor, K_p , is given as a function of the RMS load current, I_b , in % of the rated current.

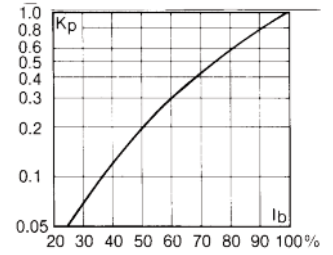

Features and Benefits

- Excellent DC performance
- Low arc voltage and low energy let-through (I^2t)
- Low watts loss
- Superior cycling capability

Typical Applications

- DC Common bus
- DC Drives
- Power converters/rectifiers
- Reduced voltage starters

Catalog Numbers

Fuse Type	Cat. Numbers		Electrical Characteristics	
	-SKN/394 Type K Indicator	Rated Voltage (Vdc)	Rated Current RMS-Amp	Watts Loss (W)
1*SKN/394	170E3914	4000	20	23
	170E3915		25	28
	170E3916		32	34
	170E3917		40	45
	170E3918		50	57
	170E3919		63	72
	170E3984		80	91
	170E3933		100	114
	170E3922		125	143
2 SKN/394	170E8882	4000	160	182
	170E8883		200	228
	170E8884		250	285
2//2SKN/394	170E8885	4000	315	360
	170E8886		350	400
	170E8887		400	455
	170E8888		450	515

DC Fuses — 4000Vdc: 20-450A

Dimensions - mm

Type 1* SKN 394

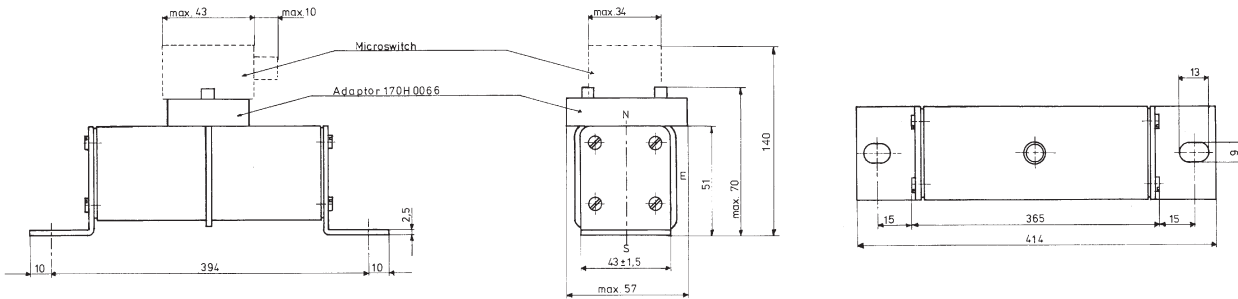

Type 2SKN 394

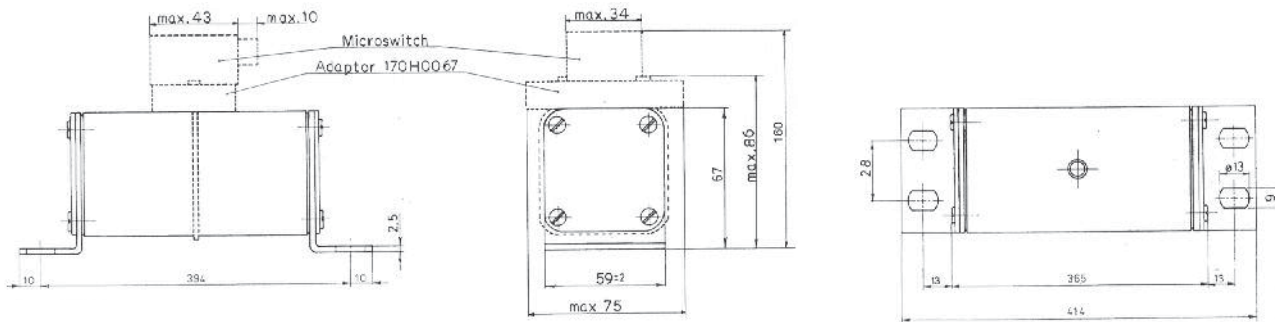

Type 2// SKN 394

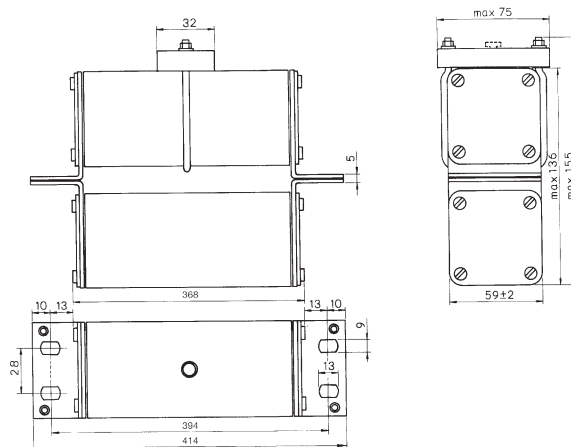

Square Body DC Fuses — 4000Vdc: 20-450A

Square Body DC Fuses — 20-125A: 2000V
Time-Current Curve

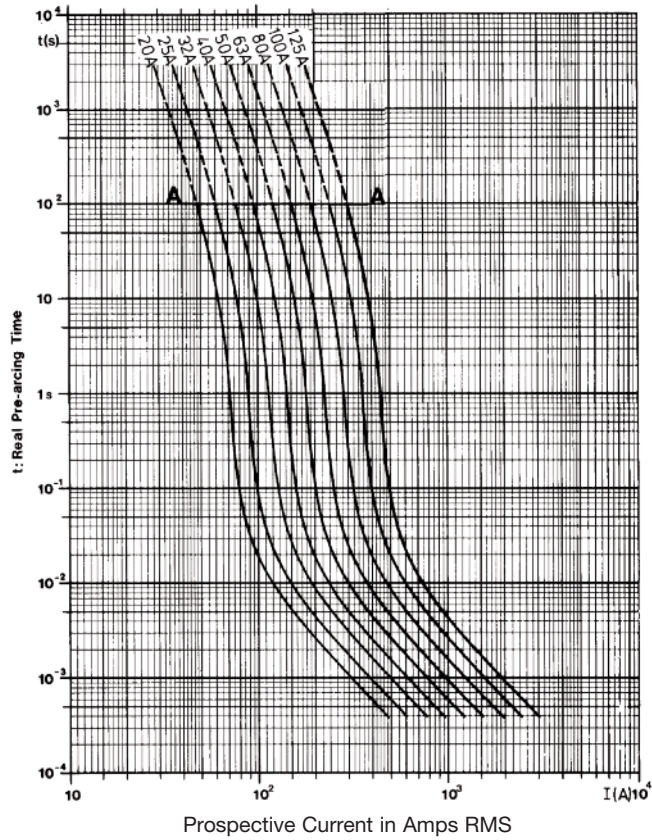

Square Body DC Fuses — 160-450A: 4000V
Time-Current Curve

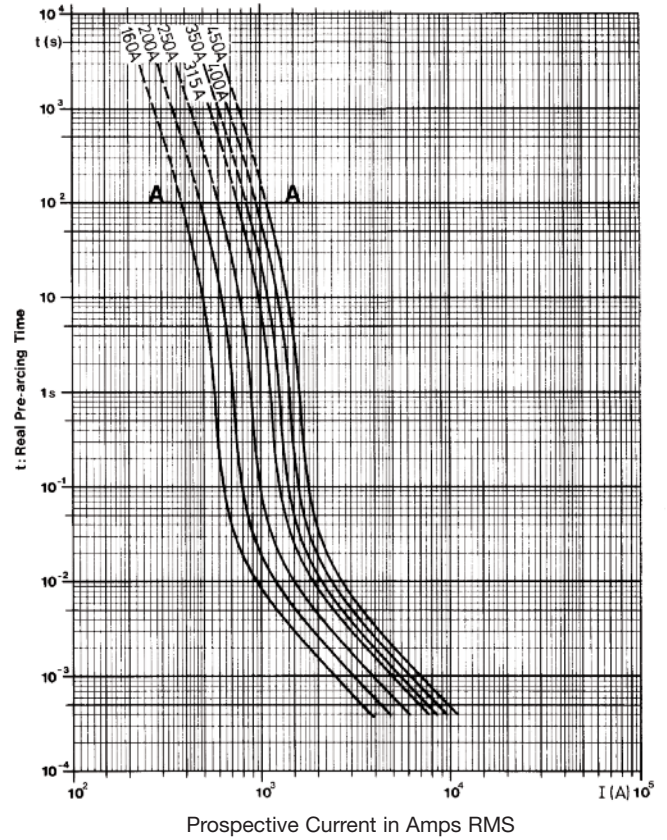

Peak Let-Through Curve

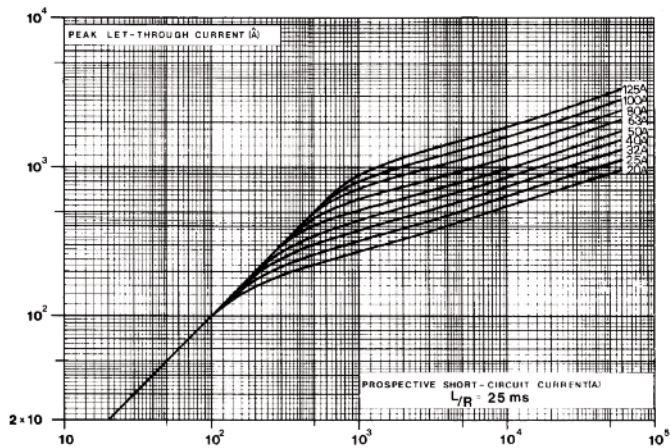

Peak Let-Through Curve

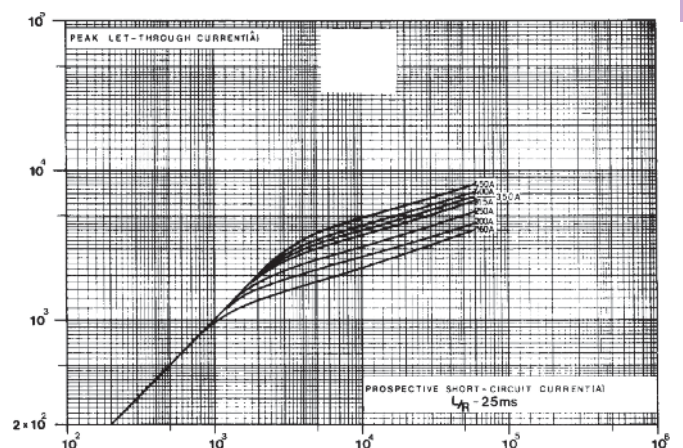

Data Sheet: Available upon request

Data Sheet: Available upon request

Square Body Fuse Accessories

Indicator Systems

Typower ZILOX fuses are available with three different indicator systems.

1. Visual Indicator

The indicator situated in one cover plate is clearly visible as soon as the fuse has operated. The minimum voltage for operating the indicator is 20V.

2. Type T Indicator

The indicator is situated on one cover plate with a cover plate tag to accommodate an auxiliary switch. The minimum voltage for operating the indicator is 20V. A special low voltage indicator (1.5V) is available on request.

3. Type K Indicator

This indicator is situated on the fuse body. It is covered by an adapter for snap-on mounting of an auxiliary switch. The operating voltage of the indicator is 1.5V. As a matter of safety, the factory mounted adapter must not be removed from the fuse.



Microswitch

The Typower ZILOX fuses with either type T indicator or type K indicator can be equipped with a microswitch for remote electrical indication of fuse operations. All microswitches have one normally open and one normally closed contact. Ratings are 2A, 250Vac.

Microswitch	6.3 x 0.8mm Lugs	2.8 x 0.5mm Lugs	Indicator Type
170H0235	X		T
170H0236	X		T
170H0237		X	T
170H0238		X	T
170H0069	X		K

Size	DIN 43 653	Type K	DIN 43 620	Type K	French Style	Type K	Flush End	Type K	US Style
	Type T		Type T		Type T		Type T		Type K
000	170H0236		170H0236						
	170H0238		170H0238						
00	170H0235						170H0235		
	170H0237						170H0237		
1*	170H0235	170H0069	170H0235		170H0236	170H0069		170H0069	170H0069
	170H0237		170H0237		170H0238				
1	170H0235	170H0069			170H0236	170H0069		170H0069	170H0069
	170H0237				170H0238				
2	170H0235	170H0069	170H0235		170H0236	170H0069		170H0069	170H0069
	170H0237		170H0237		170H0238				
3	170H0235	170H0069	170H0236		170H0236	170H0069		170H0069	170H0069
	170H0237		170H0238		170H0238				
4								170H0069	
23								170H0069	
24								170H0069	

Square Body Fuse Accessories

Fuse Bases (Blocks)

DIN 43 653 Fuse Bases

For the Typower ZILOX fuses according to DIN 43 653, the following fuse bases are available:

Catalog Number	Max Volts	Amp Rating	Center Distance
170H3003	1000	630	80mm
170H3004	1000	1250	80mm
170H3005	1400	630	110mm
170H3006	1400	1250	110mm

The fuse bases rated 1250A can also be used for the fuses with higher rated current if the maximum load current is derated according to the table below:

Fuse Amp Rating	Max Amp Load In Fuse Base
1400	1325
1500	1400
1600	1500
1800	1650
2000	1800

Fixed Center Base Style	Max Volts	Max. Fuse Amp Rating	Fuse Size
170H1007	1000	400	00, 000
170H1013	660	200	0000,000

UL Recognized to UL 512.

Universal Fuse Bases

For the Typower ZILOX fuses according to DIN 43 653, French style and North American style, the following fuse bases are available:

Modular Base Style	Max Volts	Max. Fuse Amp Rating	Data Sheet
1BS101	600	100	1206
1BS102	600	400	1207
1BS103	600	400	1208
1BS104	600	600	1209
BH-0xxx	700	200	1200
BH-1xxx	2500	400	1201
BH-2xxx	5000	400	1202
BH-3xxx	1250	700	1203

Modular fuse bases are UL Recognized to UL 512 and meet the spacing requirements of UL 347. Contact your Bussmann sales representative for more complete ordering information.

DIN 43 620 Fuse Bases

Size	Part Number
000-00	SB00-D
1*, 1	SB1-D
2,3	SB2-D

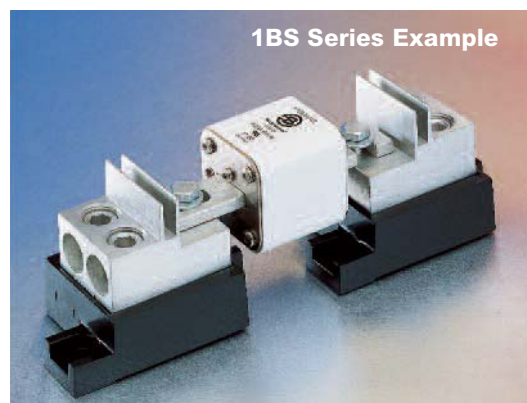
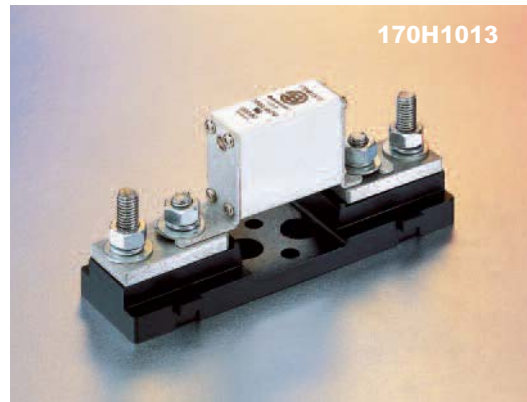
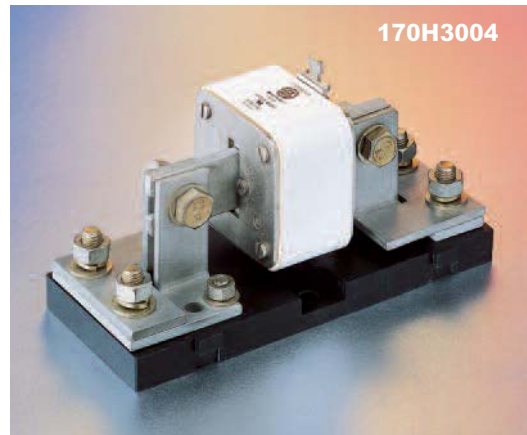

British BS 88 Fuses



Introduction

British BS 88 Contents

Fuse Volts	Amp Range	Page
240	6-900	215-217
690	6-710	218-221

Accessories

Indicator System & Fuse Bases	222
-------------------------------	-----

British BS 88 Fuse Ranges

Amps	Vac	Vdc
6-900	240	150
6-710	690	500

General Information

Designed and tested to:

- BS 88: Part 4
- IEC 269: Part 4
- UL Recognized

Bussmann offers the industry's widest range of British style semiconductor fuses and accessories.

Bussmann British style products use innovative arc quenching techniques and high grade materials to provide:

- Minimal energy let-through (I^2t)
- Excellent DC performance
- Good surge withstand profile

British style fuses are typically found in equipment manufactured in the United Kingdom or British Commonwealth countries. However, North American manufacturers have begun to specify British style fuses — particularly in UPS applications at 240V or less — to take advantage of their size, performance and cost benefits.

Voltage Rating

All Bussmann British style fuses are tested to IEC 269: Part 4. This standard requires a test voltage which is 5% higher than the rated voltage. In North America, fuses are required to clear only their rated voltage.

Accessories

Trip-indicator fuses are available for use in parallel with the main fuse. Indicator fuses can be attached to the associated fuselink, or mounted separately in panel-mounted fuseclips. In addition, a push-on adapter and microswitch attachment are available, to provide remote indication. Fuse blocks are also available for most applications.

British BS 88 — 240V: 6-900A

LCT, LET, LMT, LMMT

Specifications

Description: BS 88 style stud-mount fuses.

Dimensions: See dimensions illustrations.

Ratings:

Volts: — 240Vac/150Vdc

Amps: — 6-900A

IR: — 200kA RMS Sym.

Agency Information: CE, Designed and tested to: BS 88 Part 4, IEC 269 Part 4, UL Recognized. All fuses above have been tested at 318Vac. Consult Bussmann for specific UL Recognition status.



Electrical Characteristics

Total Clearing I²t

The total clearing I²t at rated voltage and at power factor of 15% are given in the electrical characteristics. For other voltages, the clearing I²t is found by multiplying by correction factor, K, given as a function of applied working voltage, E_g, (rms).

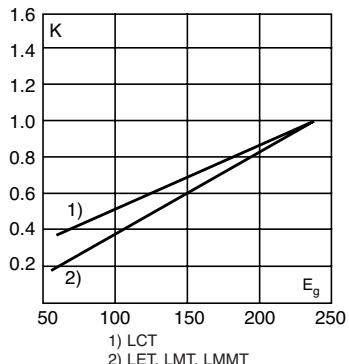

Dimensions - mm

Fig. 1: LCT

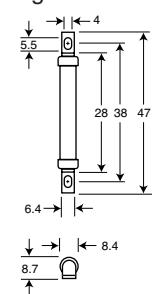

Fig. 2: LET

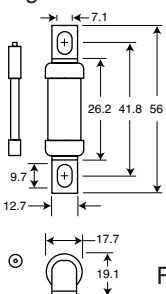

Fig. 3: LMT

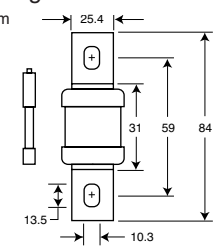
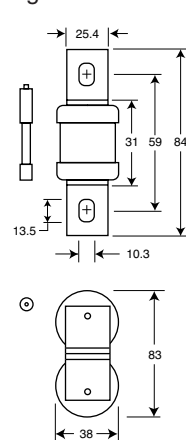

Fig. 4: LMMT



Indicator (Optional)

Arc Voltage

This curve gives the peak arc voltage, U_L, which may appear across the fuse during its operation as a function of the applied working voltage, E_g, (rms) at a power factor of 15%.

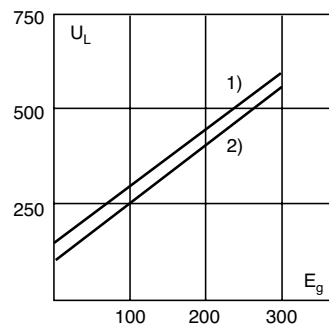

Power Losses

Watts loss at rated current is given in the electrical characteristics. The curve allows the calculation of the power losses at load currents lower than the rated current. The correction factor, K_p, is given as a function of the RMS load current, I_b, in % of the rated current.

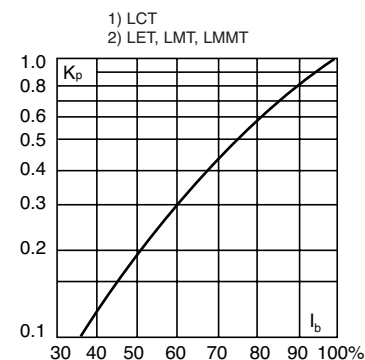

Catalog Numbers

Catalog Numbers	Type	Rated Current RMS-Amps	I ² t (A ² Sec)		Watts Loss	
			Pre-arc	Clearing		
6LCT	LCT	6	2	6	1.0	
10LCT		10	3.8	12	2.5	
12LCT		12	7	22	2.5	
16LCT		16	20	50	2.5	
20LCT		20	25	80	4.0	
25LET		LET	25	18	120	4.0
32LET	32		32	200	5.0	
35LET	35		50	320	5.0	
50LET	50		100	500	7.0	
63LET	63		180	1100	9.0	
80LET	80		300	1900	10.0	
100LET	100		600	3800	10.0	
125LET	125		600	3800	16.0	
160LET	160		1100	7000	20.0	
180LETa	180		1600	12000	29000	21.0
160LMT	LMT	160	1100	7000	17.0	
200LMT		200	1500	10000	28.0	
250LMT		250	3200	20000	28.0	
315LMT		315	6000	35000	35.0	
355LMT		355	8000	50000	35.0	
400LMT		400	14000	70000	40.0	
450LMT	450	18000	100000	220000	42.0	
400LMMT	LMMT	400	6000	35000	60.0	
500LMMT		500	14000	80000	64.0	
630LMMT		630	24000	150000	300000	75.0
710LMMT		710	32000	200000	460000	77.0
800LMMT		800	52000	300000	600000	82.0
900LMMT		900	75000	400000	800000	97.0

• Watts loss provided at rated current.
• Note: 7LET, 10LET, 12LET and 16LET are available for replacement purposes on existing equipment.
• See accessories on page 222.

Features and Benefits

- Excellent cycling capability
- Excellent DC performance
- Low arc voltage and low energy let-through (I²t)

Typical Applications

- DC Common bus
- AC and DC drives
- Power converters/rectifiers
- Reduced voltage starters

British BS 88 — 240V: 6-900A

LCT 6-20A: 240V

Time-Current Curve

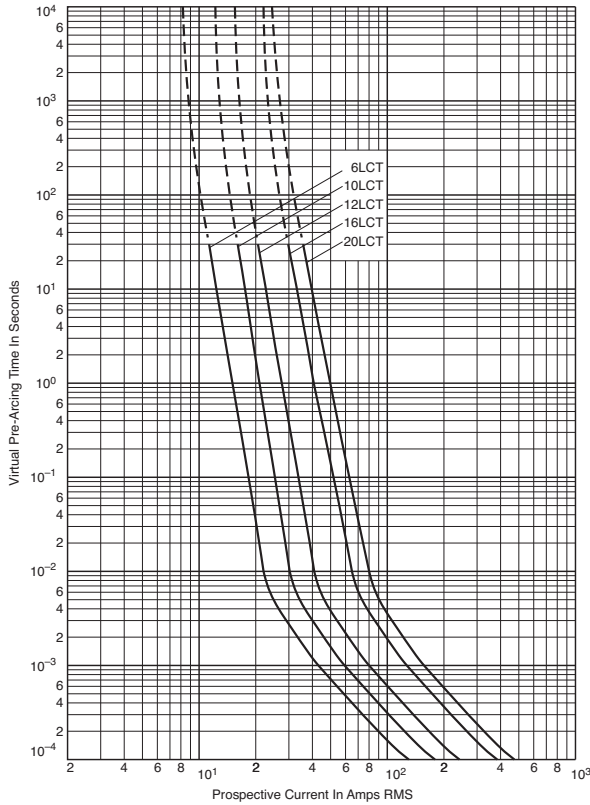

Data Sheet: 35785296

LET 25-180A: 240V

Time-Current Curve

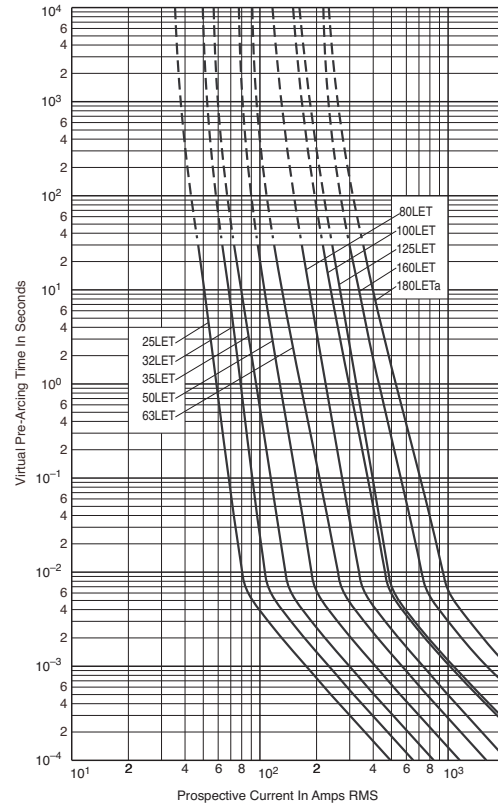

Data Sheet: 35785293

Peak Let-Through Curve

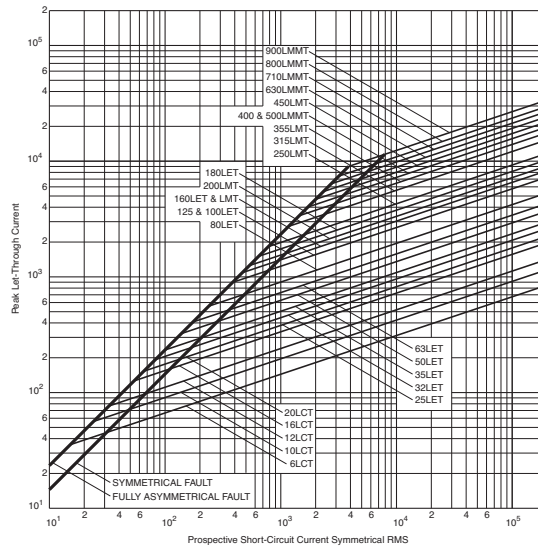

British BS 88 — 240V: 6-900A

LMT 160-450A: 240V

Time-Current Curve

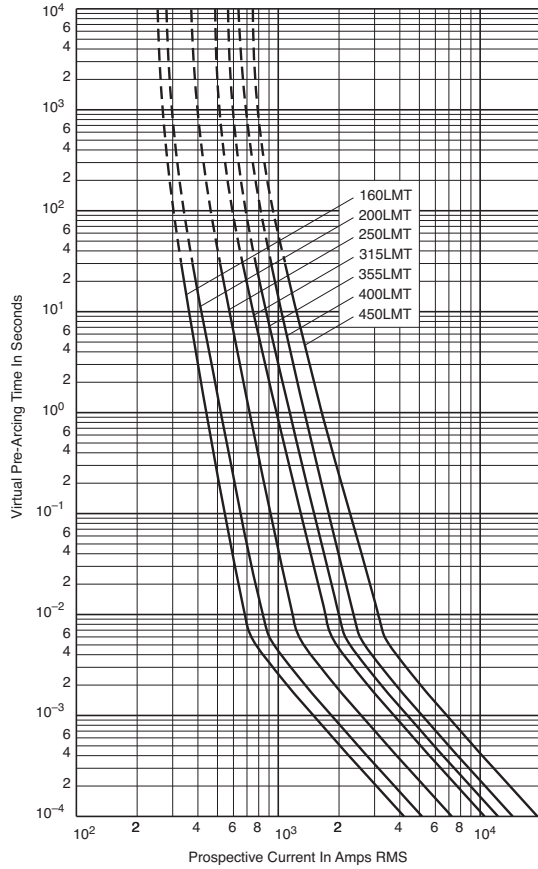

Data Sheet: 35785294

LMMT 400-900A: 240V

Time-Current Curve

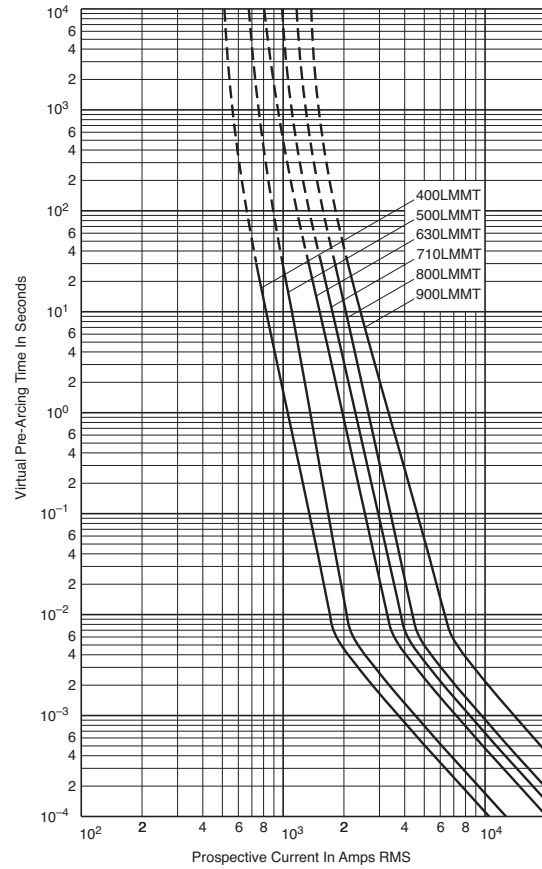

Data Sheet: 35785295

Peak Let-Through Curve

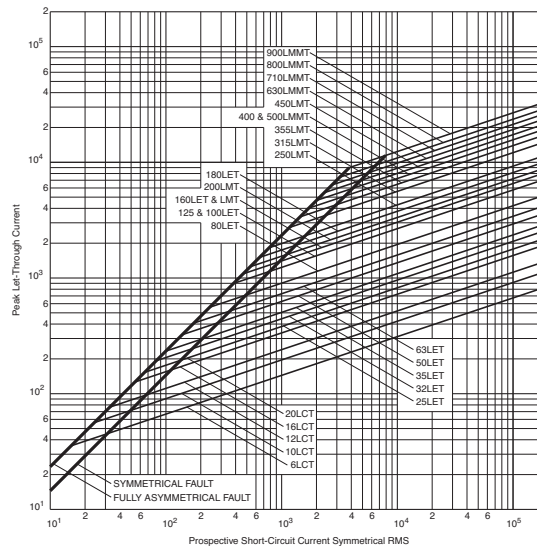

British BS 88 — 690V: 6-710A

CT, ET, FE, EET, FEE, FM, FMM, MT, MMT

Specifications

Description: BS 88 style stud-mount fuses.

Dimensions: See dimensions illustrations.

Ratings:

Volts: — 690Vac/500Vdc

Amps: — 6-710A

IR: — 200kA RMS Sym.



Agency Information: CE, Designed and tested to: BS 88 Part 4, IEC 269 Part 4, UL Recognized. MT and MMT — 350Vdc (IEC) rating. Consult Bussmann for UL Recognition status.

Electrical Characteristics

Total Clearing I²t

The total clearing I²t at rated voltage and at power factor of 15% are given in the electrical characteristics. For other voltages, the clearing I²t is found by multiplying by correction factor, K, given as a function of applied working voltage, E_g, (rms).

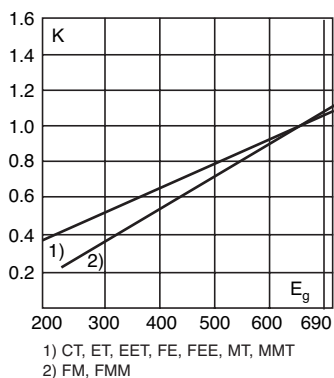

Arc Voltage

This curve gives the peak arc voltage, U_L, which may appear across the fuse during its operation as a function of the applied working voltage, E_g, (rms) at a power factor of 15%.

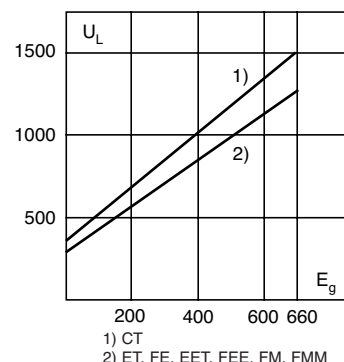

Power Losses

Watts loss at rated current is given in the electrical characteristics. The curve allows the calculation of the power losses at load currents lower than the rated current. The correction factor, K_p, is given as a function of the RMS load current, I_b, in % of the rated current.

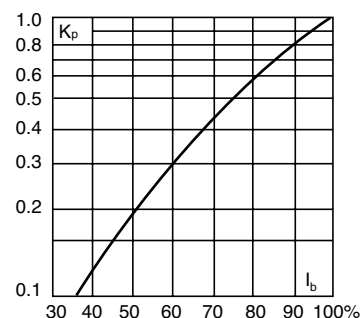

Features and Benefits

- Excellent cycling capability
- Excellent DC performance
- Low arc voltage and low energy let-through (I²t)
- Low watts loss

Typical Applications

- DC Common bus
- DC Drives
- Power converters/rectifiers
- Reduced voltage starters

Dimensions - mm

Fig. 1: CT

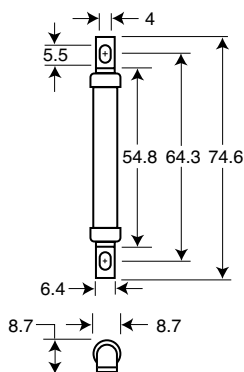

Fig. 2: ET, FE

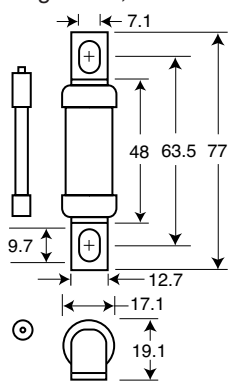

Fig. 3: EET, FEE

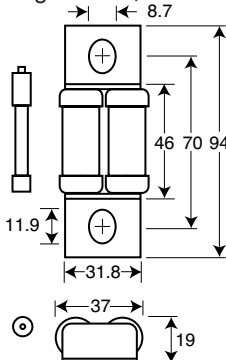

Fig. 4: FM, MT

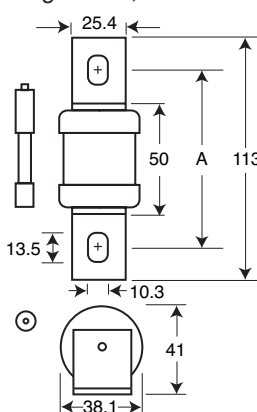
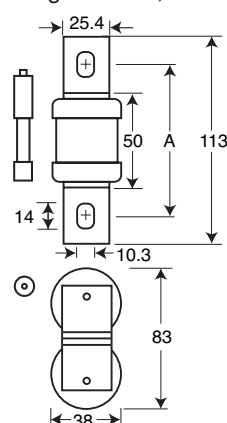

Fig. 5: FMM, MMT



1mm = 0.0394" / 1" = 25.4mm

Figs. 4 & 5 "A" Dimensions

Type	"A"
FM	80-85mm
FMM	80-85mm
MT	85mm
MMT	85mm

British BS 88 — 690V: 6-710A

Catalog Numbers

Catalog Numbers	Type	Electrical Characteristics				Watts Loss
		Rated Current RMS-Amps	Pre-arc	Pt (A ² Sec)		
				Clearing at 415V	Clearing at 660V	
6CT	CT	6	1.8	8.5	12	2
10CT		10	7	30	48	3
12CT		12	10	40	65	3
16CT		16	16	66	110	7
20CT		20	32	150	220	7
25ET	ET	25	25	150	250	7
32ET		32	32	190	350	11
35ET		35	52	310	500	11
40ET		40	103	600	900	9
45ET		45	103	680	1100	11
56ET		56	135	950	1500	14
63ET		63	171	1200	2000	16
80ET	80	360	2500	4000	18	
35FE	FE	35	33	130	200	9
40FE		40	52	180	300	9
45FE		45	76	270	450	11
50FE		50	103	380	600	11
63FE		63	135	480	750	12
71FE		71	210	600	950	17
80FE		80	250	900	1500	20
90FE		90	360	1300	2100	20
100FE		100	470	1800	2800	23
90EET		EET	90	490	3000	4500
110EET	110		600	4000	6500	27
140EET	140		1050	7000	12000	35
160EET	160		1500	10000	17000	39
100FEE	FEE	100	400	1600	2400	24
120FEE		120	540	1900	3100	32
140FEE		140	850	2500	3800	36
160FEE		160	1000	3700	5700	46
180FEE		180	1400	5300	8400	46
200FEE		200	1900	7100	11400	52
180FM	FM	180	1400	7500	13500	40
200FM		200	2600	10500	18500	40
225FM		225	3700	14500	26500	44
250FM		250	5200	20500	37500	48
280FM		280	7000	30500	55000	48
315FM		315	10000	40000	77000	55
350FM		350	15000	60000	105000	55
400FMM	FMM	400	10000	40000	72500	85
450FMM		450	15000	60000	105000	90
500FMM		500	20000	82000	150000	100
550FMM		550	30000	120000	215000	100
630FMM		630	45000	180000	310000	100
700FMM		700	60000	245000	420000	120
160MT		MT	160	2400	15000	25000
180MT	180		3800	25000	38000	26
200MT	200		6000	40000	58000	27
250MT	250		11500	80000	110000	32
280MT	280		16500	100000	150000	35
315MT	315		19000	125000	180000	42
355MT	355		22000	160000	200000	51
180MMT	MMT	180	1650	12000	18000	42
200MMT		200	2200	16000	23000	42
225MMT		225	3700	26000	40000	42
280MMT		280	6600	47000	70000	47
315MMT		315	8600	62000	91000	51
355MMT		355	13500	97000	140000	54
400MMT		400	21000	150000	220000	60
450MMT		450	30000	220000	320000	57
500MMT		500	42000	300000	450000	64
560MMT		560	60000	430000	640000	64
630MMT		630	68500	500000	720000	86
710MMT		710	78000	600000	850000	105

- Watts loss provided at rated current.
- Note: FC, 8ET, 12ET, 15ET, 20ET, 65EET and 75EET are available for replacement purposes on existing equipment.
- See accessories on page 222.

CT 6-20, ET 25-80A: 690V

Time-Current Curve

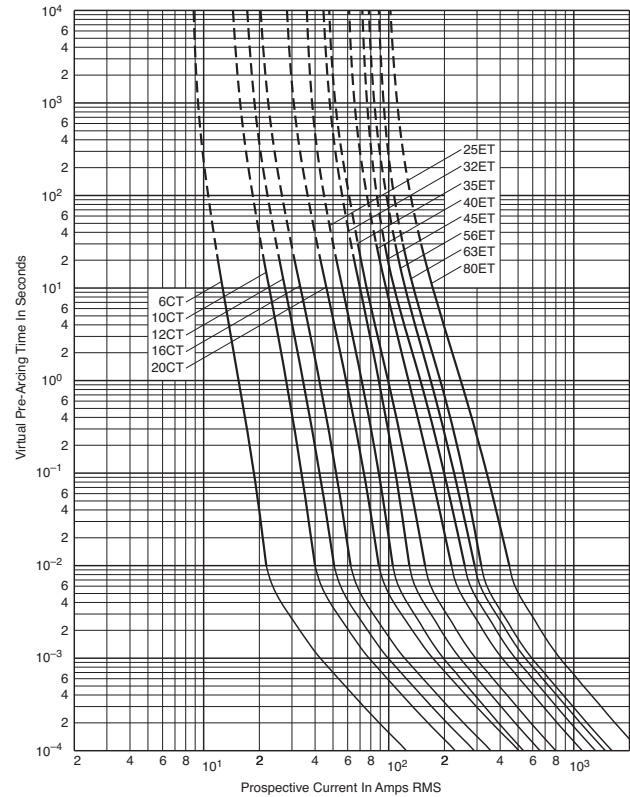

Peak Let-Through Curve

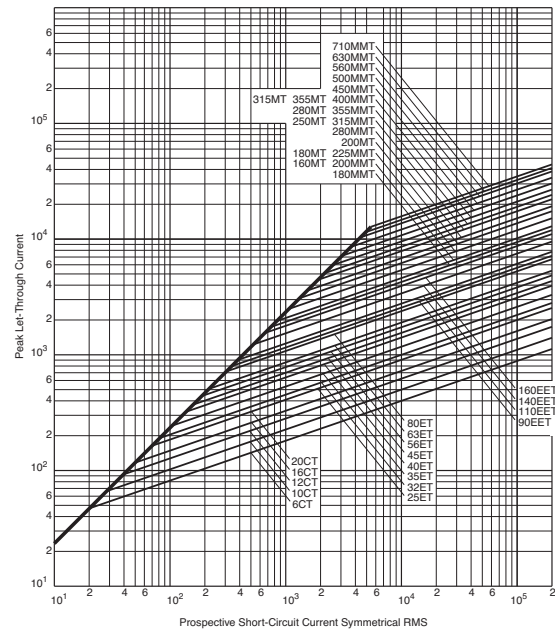

British BS 88 — 690V: 6-710A

EET 90-160A, MT 160-355A: 690V

Time-Current Curve

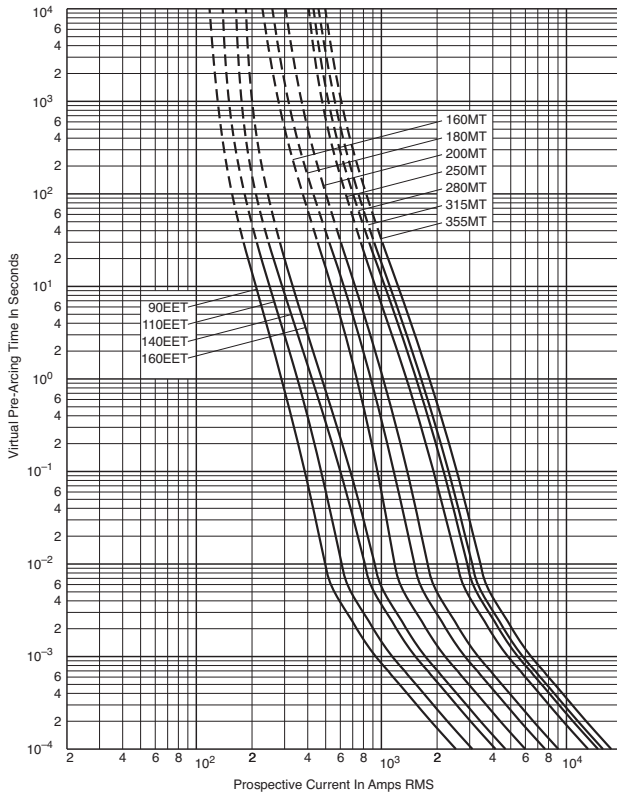

Data Sheet: 35785313

MMT 180-710A: 690V

Time-Current Curve

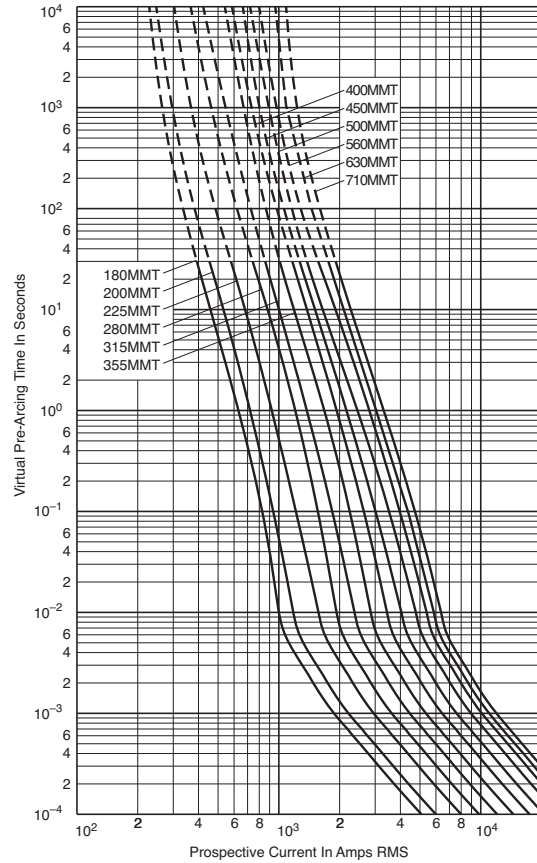

Data Sheet: 35785311

Peak Let-Through Curve

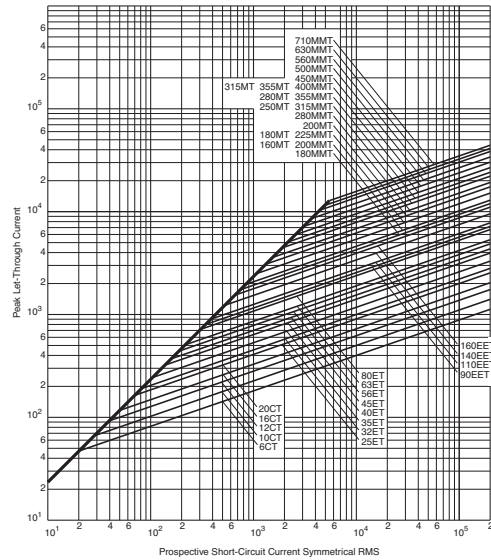

British BS 88 — 690V: 6-710A

FE 35-100A & FM 180-350A: 690V

Time-Current Curve

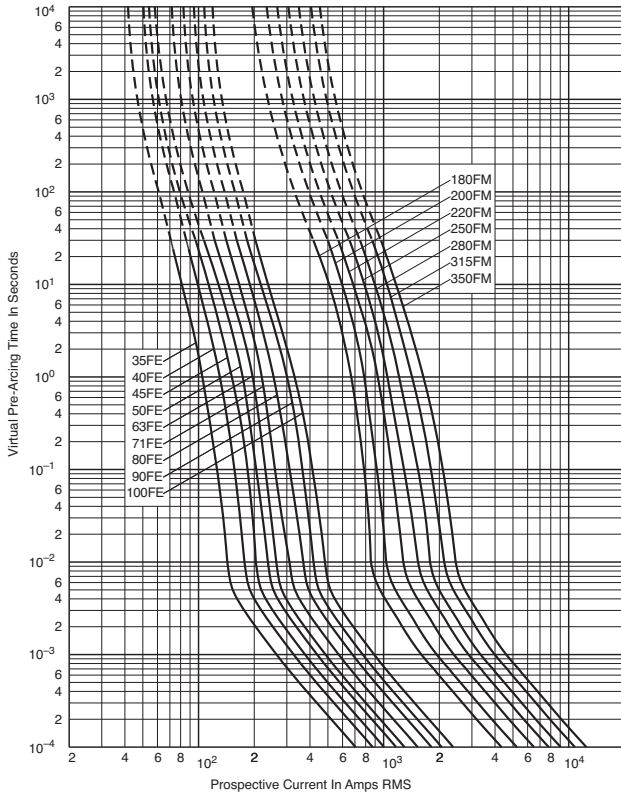

FEE 100-200A & FMM 400-700A: 690V

Time-Current Curve

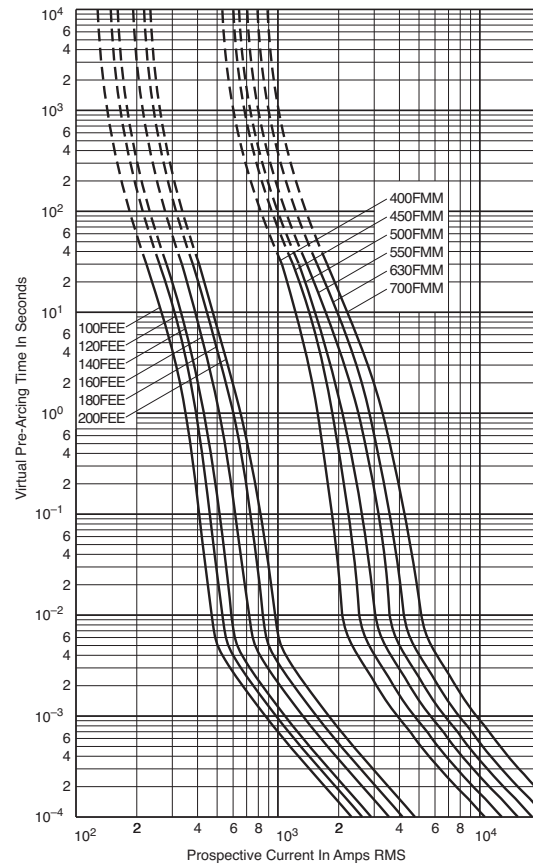

Peak Let-Through Curve

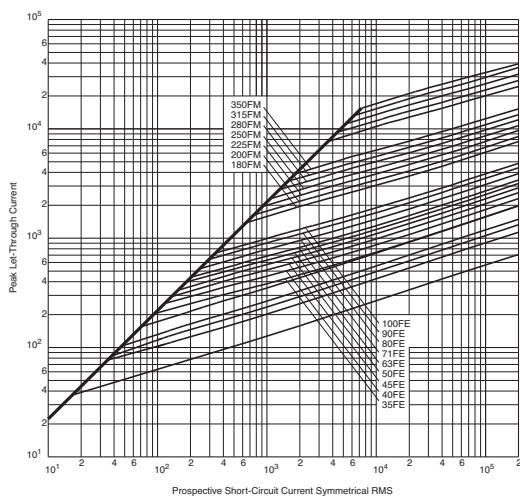

Peak Let-Through Curve

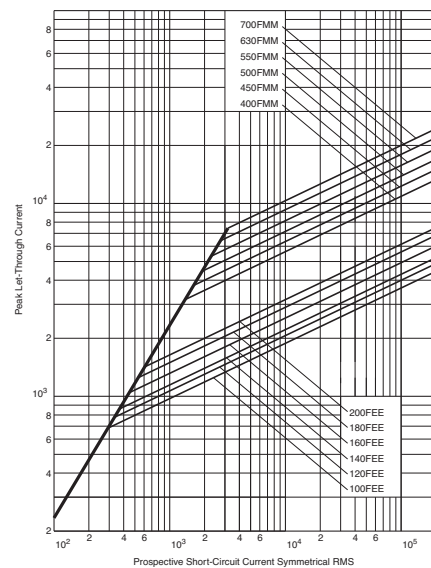

Data Sheet: 35785314

Data Sheet: 35785292

British BS 88 Fuse Accessories

Indicator System

Trip-Indicators

Trip-indicators are available for use in parallel with the main fuse. They can either be attached to the associated fuse or mounted separately in panel mounted fuse clips, reference CL1. A push-on adapter and microswitch attachment is available for use with the trip indicator to give the facility of remote indication, reference MAI.

Fuse ratings of 20A and below cannot usually accommodate a trip-indicator.

When a trip-indicator is to be attached to the main fuse an accessory pack comprising a pair of mounting clips and an appropriate trip indicator would be required. The clips are snapped onto the fuse end caps and the indicator is pressed into clips as shown.

Electrical Specifications

Type	TI500	TI700
Maximum RMS Voltage	500	700
Maximum Peak Voltage	700	1000
Maximum DC Voltage	130	350
Cold Resistance (ohms)	0.3	0.45
Maximum permissible steady-state current	1.5A	1.5A
Interrupting Capacity (RMS Symm.)	100,000	100,000
Pre-Arcing I ² t	23	23
Total I ² t (max volts)	46	46

Fuse Indicator Kits

Kit. Ref.	Details	RMS Volts	For use with Fuse Ref.
EC-250	Fuse Mount	250	LET
MC250	Indicator Kits	250	LMT & LMMT
EC-600	(Includes one	660	FE, FEE & ET
MC600	indicator	660	FM & FMM
MC700	and two clips)	700	MT & MMT

Microswitch Adapter – MAI

We offer a microswitch, complete with adapter for securing the indicator. The microswitch is provided with double pole, single throw contacts, having both a normally open and a normally closed position. A special material has been employed in the construction of the adapter to provide reliable operation in the range of temperatures associated with standard operating conditions and during fuse operation.

Microswitch and Adapter Type MAI

Current Rating:	
AC 50/60Hz resistive load @ 250V RMS	4A
AC 50/60Hz resistive load @ 127V RMS	6A
DC, resistive load @ 110Vdc	0.7A DC
DC, resistive load @ 30Vdc	2A DC
Maximum Working Voltage:	
Contact-to-contact (RMS)	1000V
Contact-to-contact (RMS)	1500V
Maximum DC Volts:	110Vdc

CL1 Panel Mount Clips

CL1 Panel mount fuse clips are available for mounting a trip-indicator when mounting directly on the fuse is impractical. Order part number CL1.



Trip-Indicator Dimensions - mm

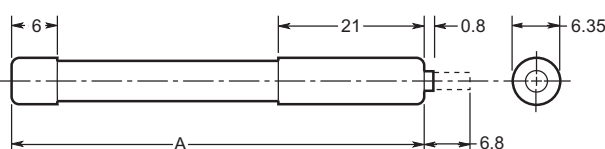

Ref.	Dim. "A" (mm)	RMS Volts
TI250	37.6	250
TI500	47.5	500
TI600	55.7	600
TI700	61.8	700
TI1100	98.4	1100
TI1500	120.6	1500
TI2000	147.5	2000
TI2500	198.3	2500

CL1 Panel Mount Clip Dimensions - mm

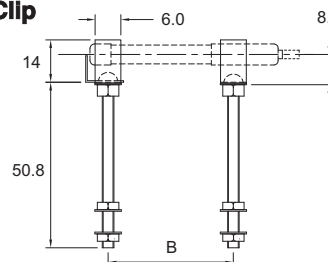

Microswitch Adapter – MAI

We offer a microswitch, complete with adapter for securing the indicator. The microswitch is provided with double pole, single throw contacts, having both a normally open and a normally closed position. A special material has been employed in the construction of the adapter to provide reliable operation in the range of temperatures associated with standard operating conditions and during fuse operation.

Microswitch and Adapter Type MAI

Current Rating:	
AC 50/60Hz resistive load @ 250V RMS	4A
AC 50/60Hz resistive load @ 127V RMS	6A
DC, resistive load @ 110Vdc	0.7A DC
DC, resistive load @ 30Vdc	2A DC
Maximum Working Voltage:	
Contact-to-contact (RMS)	1000V
Contact-to-contact (RMS)	1500V
Maximum DC Volts:	110Vdc

Terminal Arrangement



Dimensions in mm

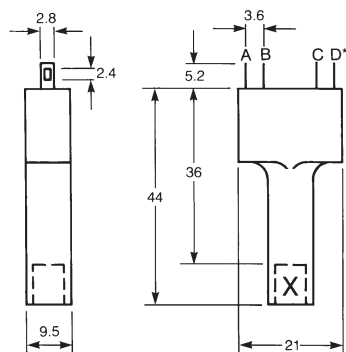

**A=D=N/O contacts
B=C=N/C contacts

Ferrule Fuses



Table of Contents

Basic Catalog Number	Volts	Amp Range	Page
FWA	150	5-60	224-225
FWX	250	1-50	226-227
FWH	500	0.25-30	228-231
FWC	600	6-32	232-233
FWP	690V/700	1-100	234-237
FWK	750	5-60	238-239
FWJ	1000	20-30	240-241
FWL/FWS	1250/1500/2000	2-30	242

Accessories

Fuse Holders	241
--------------	-----

Ferrule Fuse Ranges

Volts	Amps	AC	DC
150	5-60	X	X
250	1-50	X	X
500	0.25-30	X	X
600	6-32	X	X
700 (22 x 58mm)	20-100	X	—
700 (14 x 51mm)	1-50	X	X
750	5-60	X	X
1000	20-30	X	X (800Vdc)
1250	20-30	X	X (1000Vdc)
1500	8-15	X	X (1000Vdc)
2000	2-6	X	X (1000Vdc)

General Information

Bussmann offers a full line of ferrule style (cylindrical clip-mounted) fuses, designed and tested to meet standards and requirements in various locations around the world. Their unique design and construction provide:

- Superior cycling capability
- Low energy let-through (I²t)

Ferrule fuses provide an excellent solution for small UPS, small ac drives and other low power applications where space is at a premium.

Voltage Rating

All Bussmann ferrule fuses — except 690V — have been tested at their rated voltage. The 690V ferrule fuse has been tested to the IEC 60269 standard, which requires clearing at the rated voltage +5%.

Accessories

Ferrule fuses may be mounted in fuseclips, fuse holders, fuse blocks or fused switches. A variety of products are available. Please consult Bussmann Application Engineering to discuss your requirement.

Ferrule — FWA 150V: 5-60A

FWA 5-30A (10 x 38mm) 35-60A (21 X 51mm)

Specifications

Description: Ferrule style high speed fuses.

Dimensions: See dimensions illustration.

Ratings:

Volts — 150Vac/dc

Amps — 5-60A

IR: — 100kA Sym.

Agency Information: CE, UL Recognition JFHR2.E91958

Electrical Characteristics

Total Clearing I²t

The total clearing I²t at rated voltage and at power factor of 15% are given in the electrical characteristics. For other voltages, the clearing I²t is found by multiplying by correction factor, K, given as a function of applied working voltage, E_g, (rms).

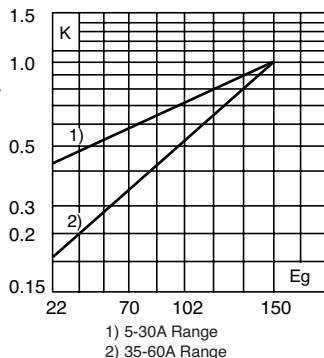

Dimensions - in (mm)

Amp Range	Dimensions		
	A	B	C
5-30	1.5 (38.1)	0.375 (9.5)	0.406 (10.3)
35-60	2.0 (50.8)	0.625 (15.9)	0.811 (20.6)

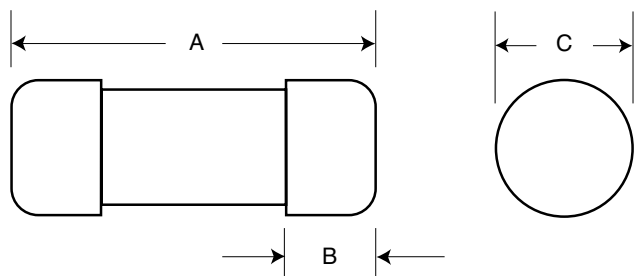

Arc Voltage

This curve gives the peak arc voltage, U_L, which may appear across the fuse during its operation as a function of the applied working voltage, E_g, (rms) at a power factor of 15%.

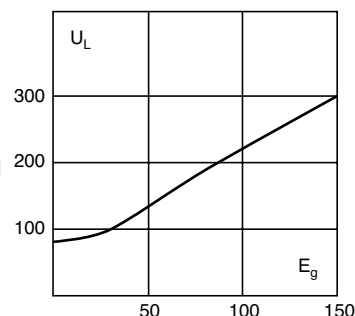

Power Losses

Watts loss at rated current is given in the electrical characteristics. The curve allows the calculation of the power losses at load currents lower than the rated current. The correction factor, K_p, is given as a function of the RMS load current, I_b, in % of the rated current.

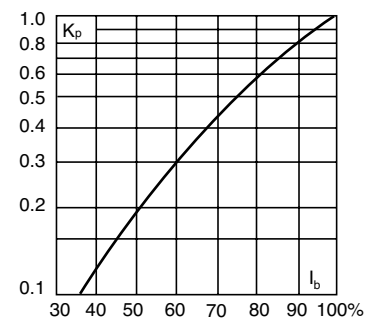

Catalog Numbers

Catalog Numbers	Size	Electrical Characteristics			
		Rated Current RMS-Amps	I ² t (A ² Sec)		Watts Loss
			Pre-arc	Clearing at 150V	
FWA-5A10F		5	1.6	8	1
FWA-10A10F		10	3.6	16	2.7
FWA-15A10F	10 x 38mm	15	14	55	3.3
FWA-20A10F	(¹³ / ₃₂ " x 1 1/2")	20	33	130	3.8
FWA-25A10F		25	58	220	4.9
FWA-30A10F		30	100	400	4.9
FWA-35A21F		35	75	800	4.5
FWA-40A21F		40	100	1000	5.1
FWA-45A21F	21 x 51mm	45	130	1300	6
FWA-50A21F	(¹³ / ₁₆ " x 2")	50	170	1600	7.3
FWA-60A21F		60	250	2400	8.0

• Watts loss provided at rated current.
• See accessories on page 243.

Features and Benefits

- Excellent cycling capability and DC performance
- Low arc voltage and low energy let-through (I²t)
- Low watts loss in a compact size
- Used with finger-safe holders/blocks

Typical Applications

- DC Common bus
- DC Drives
- Power converters/rectifiers
- Reduced voltage starters

Ferrule — FWA 150V: 5-60A

FWA 5-30A: 150V (10 x 38mm)

Time-Current Curve

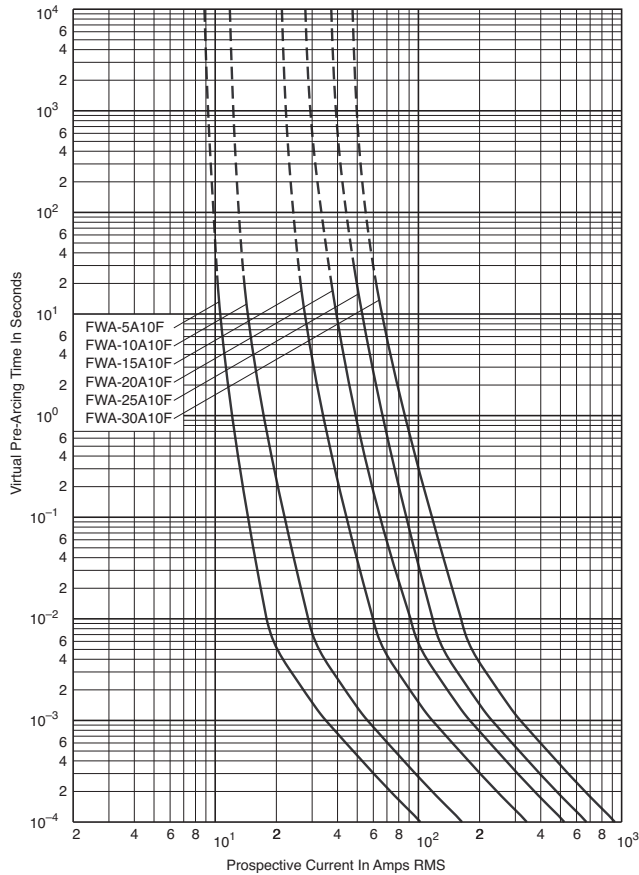

Peak Let-Through Curve

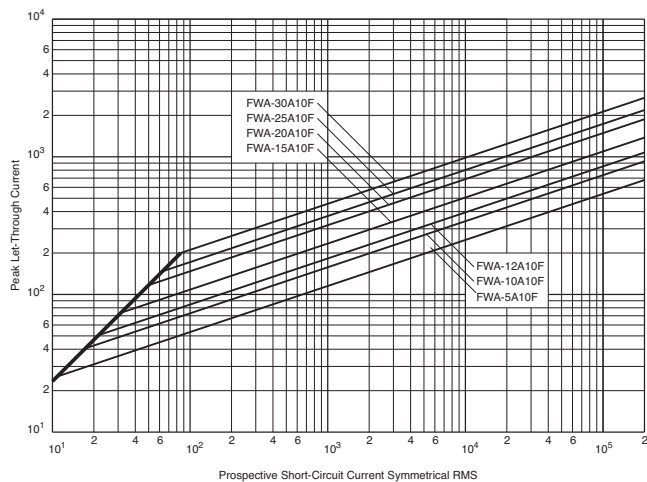

Data Sheet: 35785317

FWA 35-60A: 150V (21 x 51mm)

Time-Current Curve

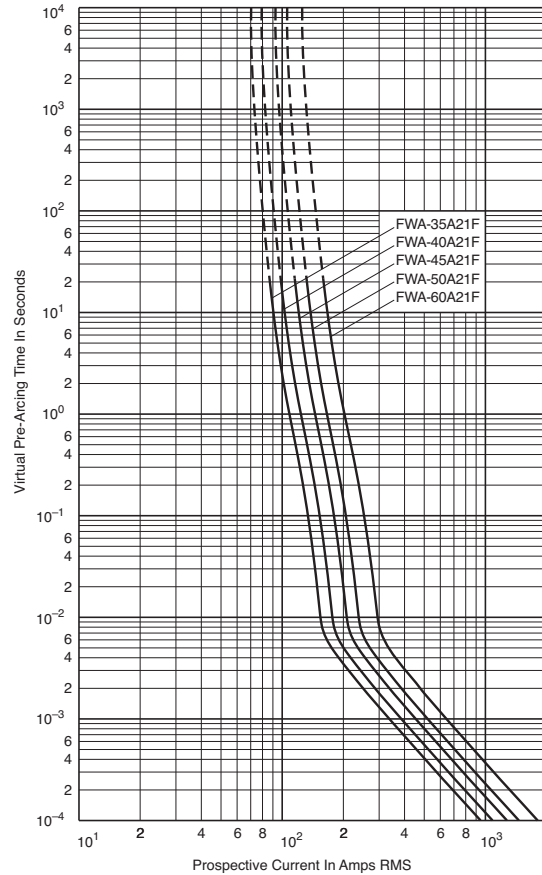

Peak Let-Through Curve

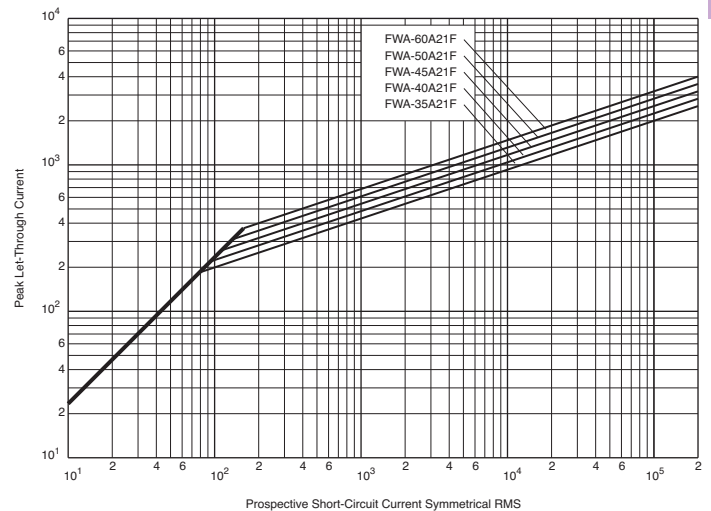

Data Sheet: 35785305

Ferrule — FWX 250V (UL): 1-50A

FWX (14 x 51mm)

Specifications

Description: Ferrule style high speed fuses.

Dimensions: See dimensions illustration.

Ratings:

Volts: — 250Vac/dc

Amps: — 1-50A

IR: — 200kA RMS Sym.

— 50kA @ 250Vdc

Agency Information: CE, UL Recognition JFHR2.E91958 1-50A & CSA Component Acceptance file Class 1422-30, 1422-90 (53787) 5-30A

Electrical Characteristics

Total Clearing I²t

The total clearing I²t at rated voltage and at power factor of 15% are given in the electrical characteristics. For other voltages, the clearing I²t is found by multiplying by correction factor, K, given as a function of applied working voltage, E_g, (rms).

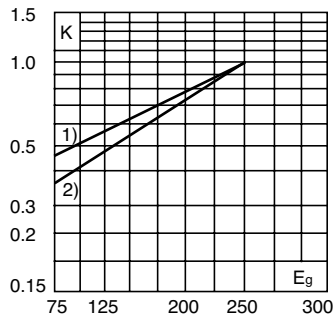

Dimensions - mm (in)

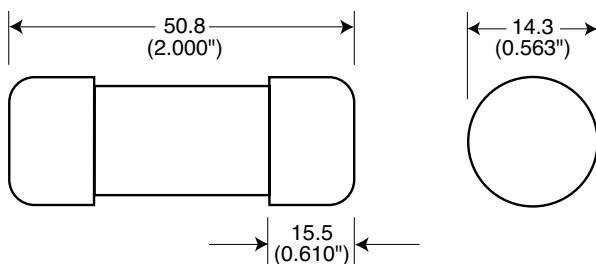

Arc Voltage

This curve gives the peak arc voltage, U_L, which may appear across the fuse during its operation as a function of the applied working voltage, E_g, (rms) at a power factor of 15%.

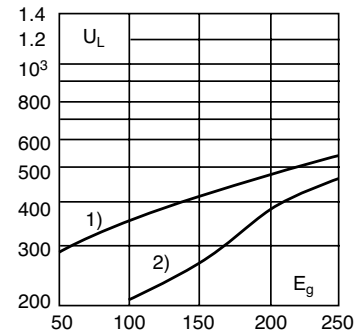

Power Losses

Watts loss at rated current is given in the electrical characteristics. The curve allows the calculation of the power losses at load currents lower than the rated current. The correction factor, K_p, is given as a function of the RMS load current, I_b, in % of the rated current.

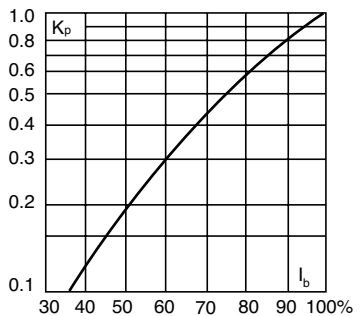

Catalog Numbers

Catalog Number	Size	Electrical Characteristics			
		Rated Current RMS-Amps	I ² t (A ² Sec)		Watts Loss
			Pre-arc	Clearing at 250V	
FWX-1A14F	14 x 51mm (¹ / ₁₆ " x 2")	1	—	—	—
FWX-2A14F		2	—	—	—
FWX-3A14F		3	—	—	—
FWX-4A14F		4	—	—	—
FWX-5A14F		5	1.6	13	1.3
FWX-10A14F		10	3.6	24	3.4
FWX-15A14F		15	14	83	3.8
FWX-20A14F		20	33	200	4.6
FWX-25A14F		25	58	300	5.3
FWX-30A14F		30	100	500	5.9
FWX-50A14F	50	200	1800	5.7	

• Watts loss provided at rated current.
• (250Vdc/Interrupting rating 50kA) UL Recognition & CSA Component Acceptance on 5 through 30A only. Consult Bussmann for additional ratings.
• See accessories on page 243.

Features and Benefits

- Excellent cycling capability and DC performance
- Low arc voltage and low energy let-through (I²t)
- Low watts loss in a compact size
- Used with finger-safe holders/blocks

Typical Applications

- DC Common bus
- DC Drives
- Power converters/rectifiers
- Reduced voltage starters

Ferrule — FWX 250V (UL): 1-50A

FWX 1-30A: 250V (14 x 51mm)

Time-Current Curve

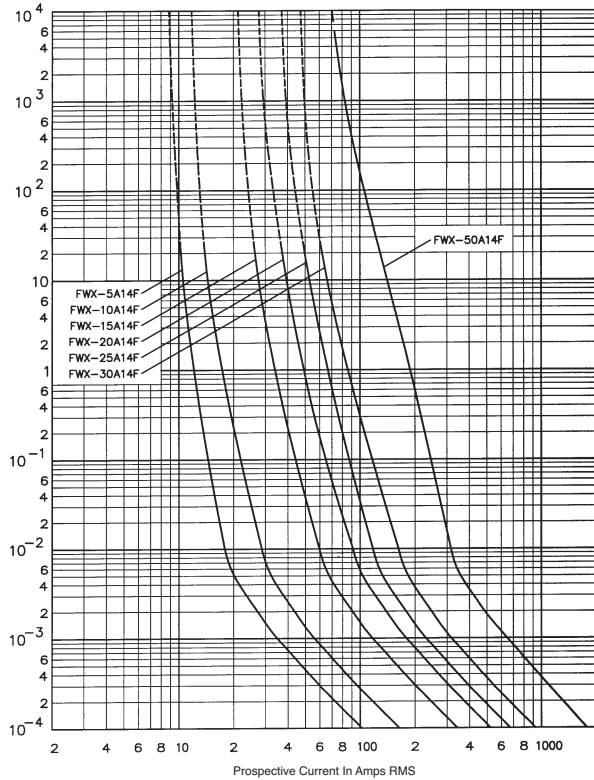

Peak Let-Through Curve

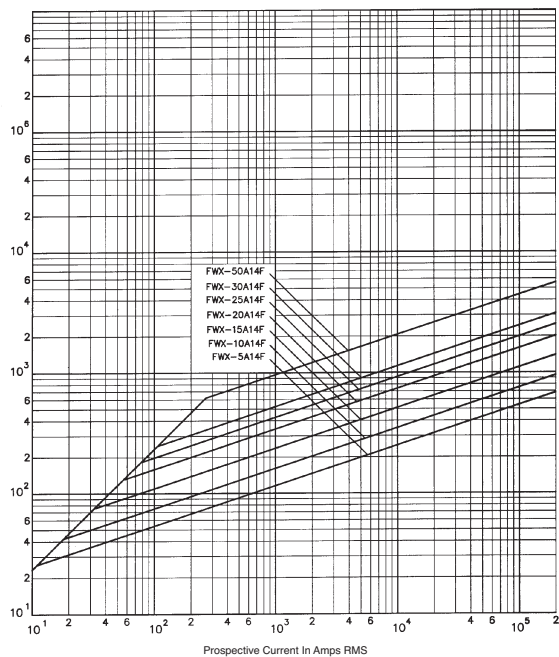

Data Sheet: 35785302

Ferrule — FWH 500V: 0.25-30A

FWH (6 x 32mm)

Specifications

Description: Ferrule style high speed fuses.

Dimensions: See dimensions illustrations.

Ratings:

Volts: — 500Vac (0.25-6.3A)
500Vdc (2-5A)

Amps: — 0.25-30A

IR: — 50kA at ≥ 20% pf (0.25-20A)
— 20kA at ≥ 20% pf (25-30A)

Agency Information: CE, UL Recognition JFHR2.E91958
0.25-30A, CSA Component Acceptance file Class 1422-30,
1422-90 (53787) 0.25-7A

Opening Times

Amp Ratings	150%	200%	300%
0.25-7	> 30 min	< 30 min	≤ 10 sec
10-30	< 30 min	< 30 min	≤ 10 sec



Dimensions - mm (inches)

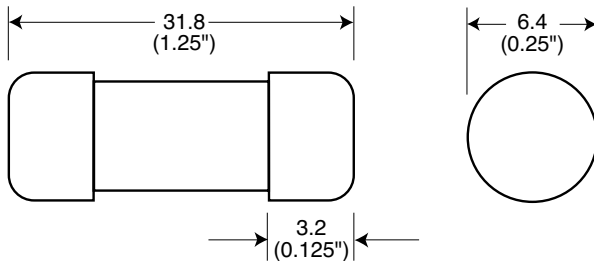

Catalog Numbers

Catalog Numbers	Size	Rated Current RMS-Amps	Electrical Characteristics		Watts Loss
			I ² t (A ² Sec)		
			Pre-arc	Clearing at 500V	
FWH-.250A6F		0.25*	0.01	0.05	2.7
FWH-.500A6F		0.5*	0.05	0.25	1.2
FWH-001A6F		1*	0.4	2	1.7
FWH-002A6F		2*	1.3	3.5	3.2
FWH-3.15A6F		3.15*	3.1	7.7	2.9
FWH-005A6F		5*	15	40	2.1
FWH-6.30A6F	6 x 32mm	6.3*	36	90	2.3
FWH-007A6F	(¼" x 1¼")	7*	50	125	2.5
FWH-010A6F		10**	9.9	139	2.86
FWH-12.5A6F		12.5**	20	60	3.53
FWH-015A6F		15**	44	146	3.08
FWH-016A6F		16**	48	177	4.48
FWH-020A6F		20**	75	259	4.26
FWH-025A6F		25**	126	345	—
FWH-030A6F		30**	145	430	—

*300% minimum opening current at rated voltage.
**200% minimum opening current at rated voltage.
• Consult Bussmann for DC ratings.
• See accessories on page 243.

Features and Benefits

- Excellent cycling capability and DC performance
- Low arc voltage and low energy let-through (I²t)
- Low watts loss in a compact size
- Used with finger-safe holders/blocks

Typical Applications

- DC Common bus
- DC Drives
- Power converters/rectifiers
- Reduced voltage starters

Ferrule — FWH 500V: 0.25-30A

FWH 0.25-7A: 500V (6 x 32mm)

Time-Current Curve

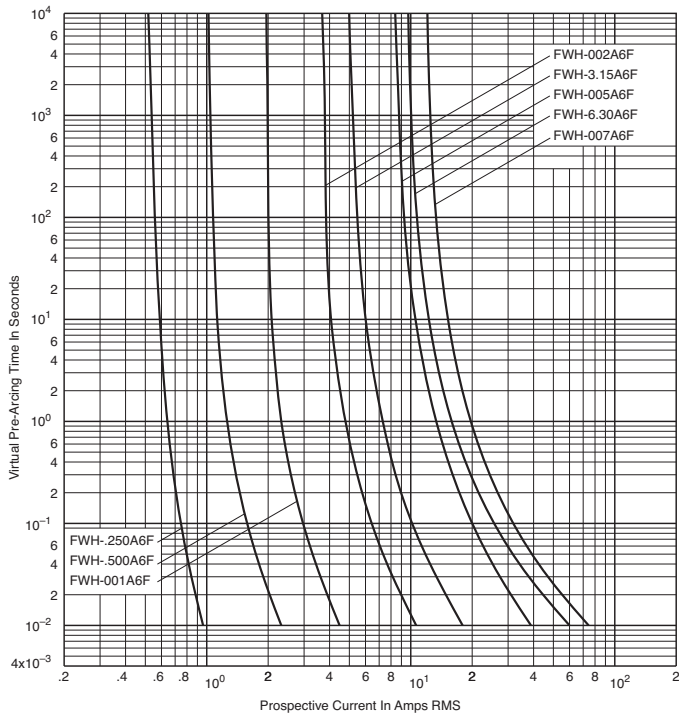

FWH 10-30A: 500V (6 x 32mm)

Time-Current Curve

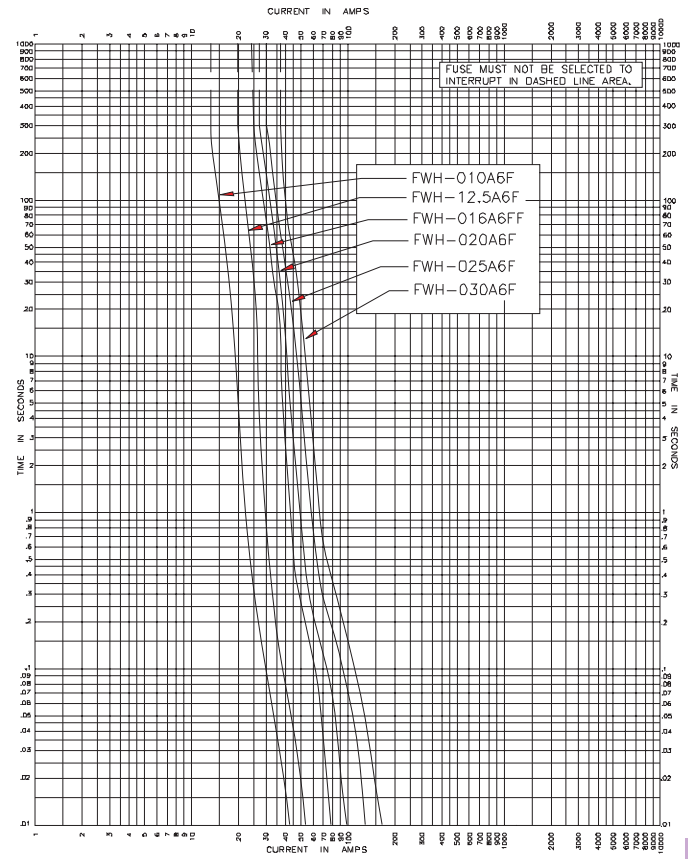

Ferrule — FWH 500V: 1-30A

FWH (14 x 51mm)

Specifications

Description: Ferrule style high speed fuses.

Dimensions: See Dimensions illustration.

Ratings:

Volts: — 500Vac

Amps: — 1-30A

IR: — 200kA RMS Sym.

— 50kA @500Vdc

Agency Information: CE, UL Recognition 1- 30A & CSA Component Acceptance file Class 1422-30, (53787) on: 5 - 30A.



Electrical Characteristics

Total Clearing I²t

The total clearing I²t at rated voltage and at power factor of 15% are given in the electrical characteristics. For other voltages, the clearing I²t is found by multiplying by correction factor, K, given as a function of applied working voltage, E_g, (rms).

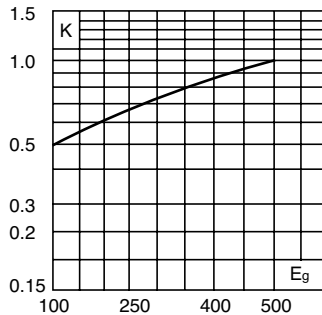

Dimensions - mm (inches)

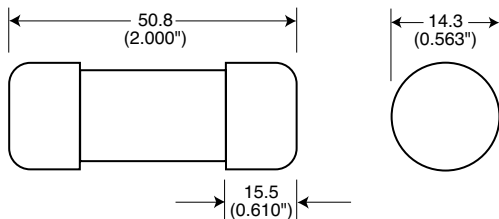

Arc Voltage

This curve gives the peak arc voltage, U_L, which may appear across the fuse during its operation as a function of the applied working voltage, E_g, (rms) at a power factor of 15%.

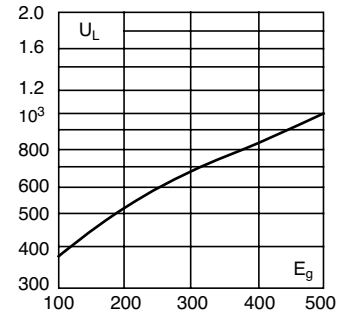

Power Losses

Watts loss at rated current is given in the electrical characteristics. The curve allows the calculation of the power losses at load currents lower than the rated current. The correction factor, K_p, is given as a function of the RMS load current, I_b, in % of the rated current.

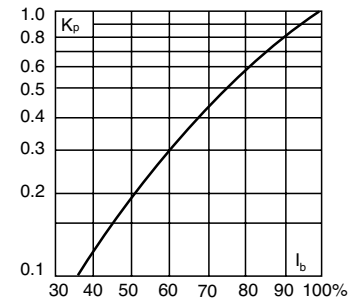

Catalog Numbers

Catalog Numbers	Size	Electrical Characteristics			
		Rated Current RMS-Amps	I ² t (A ² Sec)		Watts Loss
			Pre-arc	Clearing at 500V	
FWH-1A14F	14 x 51mm	1	—	—	—
FWH-2A14F	(1/8" x 2")	2	—	—	—
FWH-3A14F		3	—	—	2.3
FWH-4A14F		4	—	—	—
FWH-5A14F		5	1.6	6.4	1.5
FWH-6A14F		6	1.6	6.4	1.5
FWH-10A14F		10	3.6	13	4
FWH-12A14F		12	—	—	—
FWH-15A14F		15	10	40	5.5
FWH-20A14F		20	26	96	6
FWH-25A14F		25	49	191	7
FWH-30A14F		30	58	232	9

• Watts loss provided at rated current.
• See accessories on page 243.

Features and Benefits

- Excellent cycling capability and dc performance
- Low arc voltage and low energy let-through (I²t)
- Low watts loss in a compact size
- Used with finger-safe holders/blocks

Typical Applications

- DC common bus
- DC drives
- Power converters/rectifiers
- Reduced voltage starters

Ferrule — FWH 500V: 1-30A

FWH 1-30A: 500V (14 x 51mm)

Time-Current Curve

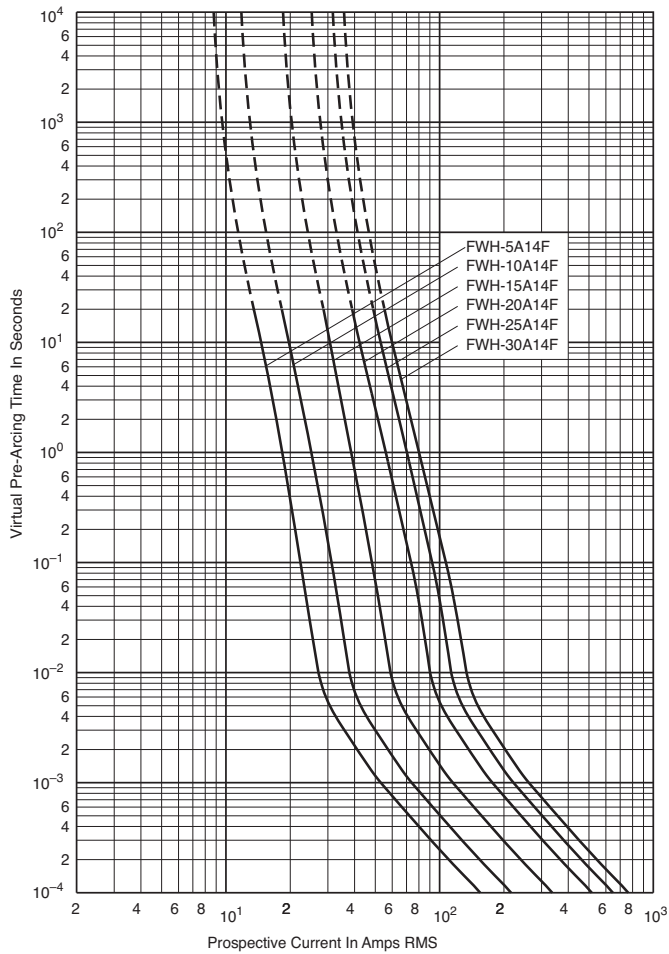

Peak Let-Through Curve

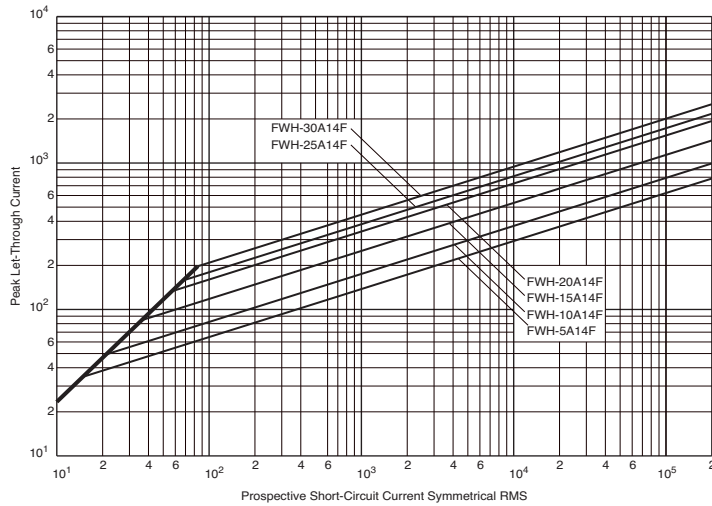

Data Sheet: 35785298

Ferrule — FWC 600V: 6-32A

FWC (10 x 38mm)

Specifications

Description: Ferrule style high speed fuses.

Dimensions: See dimensions illustration.

Ratings:

Volts: — 600Vac/700Vdc (6-25A)
600Vac (30-32A)

Amps: — 6-32A

IR: — 200kA RMS Sym.

— 50kA @ 700Vdc (6-25A)

Agency Information: CE, UL Recognition JFHR8.E91958 6-32A. & CSA Component Acceptance file Class 1422-30, (53787) on (6-32A)

Electrical Characteristics

Total Clearing I²t

The total clearing I²t at rated voltage and at power factor of 15% are given in the electrical characteristics. For other voltages, the clearing I²t is found by multiplying by correction factor, K, given as a function of applied working

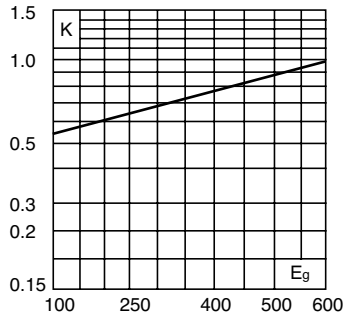

Dimensions - mm (in)

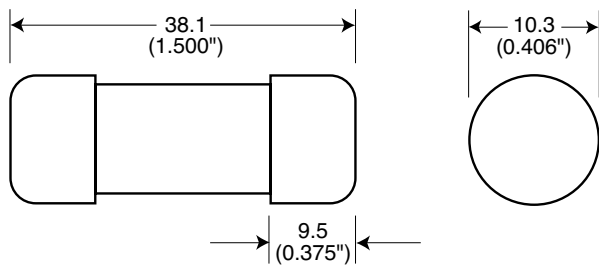

voltage, E_g , (rms).

Arc Voltage

This curve gives the peak arc voltage, U_L , which may appear across the fuse during its operation as a function of the applied working voltage, E_g , (rms) at a power factor of 15%.

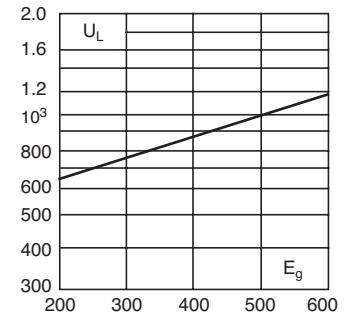

Power Losses

Watts loss at rated current is given in the electrical characteristics. The curve allows the calculation of the power losses at load currents lower than the rated current. The correction factor, K_p , is given as a function of the RMS load current, I_b , in % of the rated current.

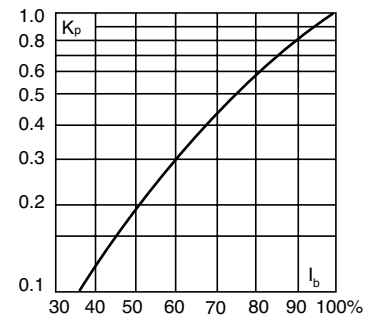

Catalog Numbers

Catalog Numbers	Size	Electrical Characteristics			
		Rated Current RMS-Amps	I ² t (A ² Sec)		Watts Loss
			Pre-arc	Clearing at 600V	
FWC-6A10F	10 x 38mm (¹³ / ₃₂ " x 1 ¹ / ₂ ")	6	4	30	1.5
FWC-8A10F		8	6	50	2.0
FWC-10A10F		10	9	70	2.5
FWC-12A10F		12	15	120	3.0
FWC-16A10F		16	25	150	3.5
FWC-20A10F		20	34	260	4.8
FWC-25A10F		25	60	390	6.0
FWC-30A10F		30	95	600	7.5
FWC-32A10F		32	95	600	7.5

• Watts loss provided at rated current.
• See accessories on page 243.

Features and Benefits

- Excellent cycling capability and DC performance
- Low arc voltage and low energy let-through (I²t)
- Low watts loss in a compact size
- Used with finger-safe holders/blocks

Typical Applications

- DC Common bus
- DC Drives
- Power converters/rectifiers
- Reduced voltage starters

Ferrule — FWC 600V: 6-32A

FWC 6-32A: 600V (10 x 38mm)

Time-Current Curve

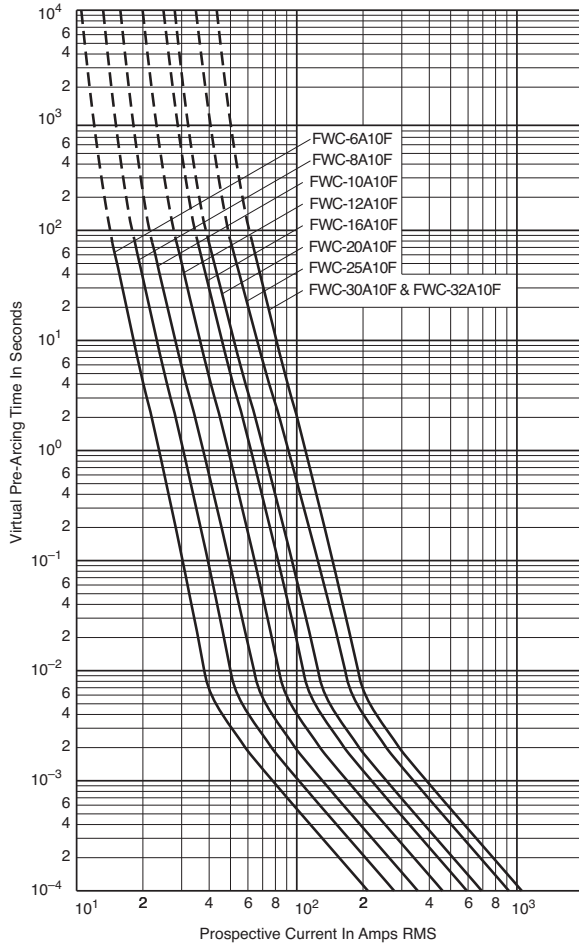

Peak Let-Through Curve

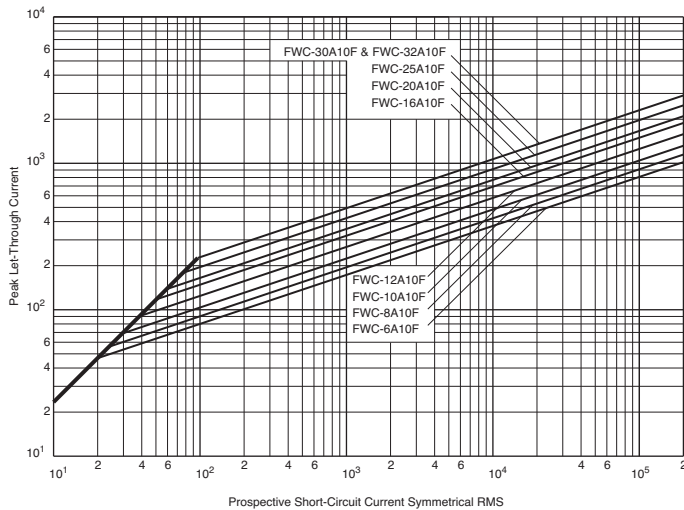

Data Sheet: 35785306

Ferrule — FWP 690V/700V (IEC/UL): 1-50A, Striker Optional

FWP (14 x 51mm)

Specifications

Description: Ferrule style high speed fuses with and without indicating striker.

Dimensions: See dimensions illustrations.

Ratings:

- Volts: — 690Vac (IEC)
- 700Vac (UL)
- 800Vdc (5-50A)
- Amps: — 1-50A
- IR: — 200kA RMS Sym.
- 50kA @800Vdc

Agency Information: CE, UL Recognition JFHR2.E91958, CSA Component Acceptance file Class 1422-30, 1422-90 (53787) for versions without indicator only. Designed and tested to IEC 60269: Part 4.

Electrical

Characteristics

Total Clearing I²t

The total clearing I²t at rated voltage and at power factor of 15% are given in the electrical characteristics. For other voltages, the clearing I²t is found by multiplying by correction factor, K, given as a function of applied working voltage, E_g, (rms).

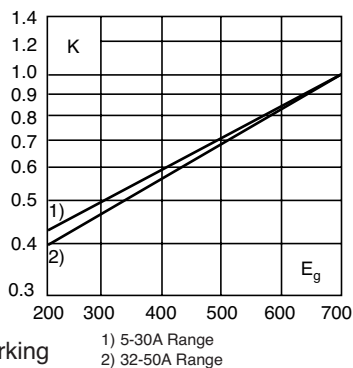

Dimensions - mm (in)

Without Striker

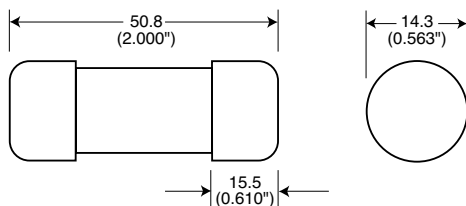

With Striker

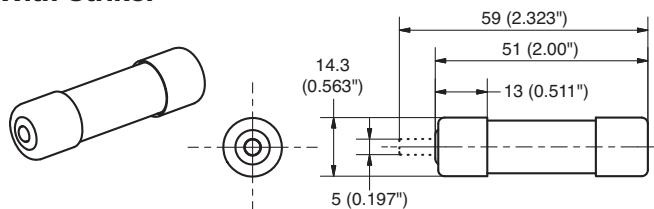

Arc Voltage

This curve gives the peak arc voltage, U_L, which may appear across the fuse during its operation as a function of the applied working voltage, E_g, (rms) at a power factor of 15%.

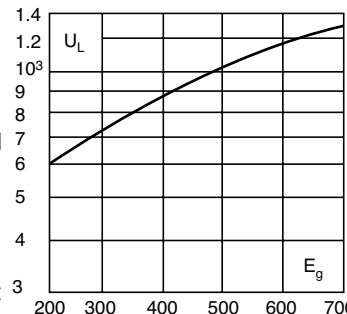

Power Losses

Watts loss at rated current is given in the electrical characteristics. The curve allows the calculation of the power losses at load currents lower than the rated current. The correction factor, K_p, is given as a function of the RMS load current, I_b, in % of the rated current.

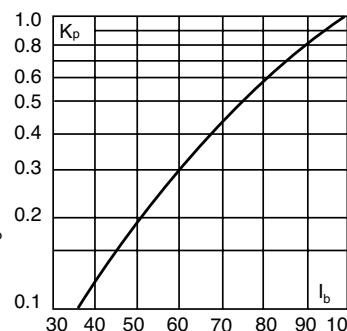

Catalog Numbers

Catalog Numbers	Size	Electrical Characteristics			
		Current RMS-Amps	Rated Minimum Melting	I ² t (A ² Sec) Clearing At Rated Voltage	Watts Loss
Without Striker	14 x 51mm ($\frac{1}{2}$ " x 2")	1	—	—	—
FWP-1A14F		2	—	—	—
FWP-2A14F		2.5	—	—	—
FWP-2.5A14F		3	—	—	—
FWP-3A14F		4	—	—	—
FWP-4A14F		5	1.6	11.0	1.5
FWP-5A14F		10	3.6	38.5	4
FWP-10A14F		15	8.6	70	5.5
FWP-15A14F		20	26.0	230	6
FWP-20A14F		25	46.5	375	7
FWP-25A14F		30	58	485	9
FWP-30A14F	32	68	600	7.6	
FWP-32A14F	40	84	750	8	
FWP-40A14F	50	200	1800	9	
With Striker*	14 x 51mm ($\frac{1}{2}$ " x 2")	10	3.6	38.5	4
FWP-10A14FI		15	8.6	70	5.5
FWP-15A14FI		20	26.0	230	6
FWP-20A14FI		25	46.5	375	7
FWP-25A14FI		30	58	485	9
FWP-30A14FI		32	68	600	7.6
FWP-32A14FI		40	84	750	8
FWP-40A14FI	50	200	1800	9	

*Striker range is 600Vdc only
• Watts loss provided at rated current.
• See accessories on page 243.

Features and Benefits

- Excellent cycling capability and DC performance
- Low arc voltage and low energy let-through (I²t)
- Low watts loss in a compact size
- Used with finger-safe holders/blocks

Data Sheet: 720025

Ferrule — FWP 690V/700V (IEC/UL): 1-50A, Striker Optional

Without Striker

FWP 5-50A: 660V/700V (14 x 51mm)

Time-Current Curve

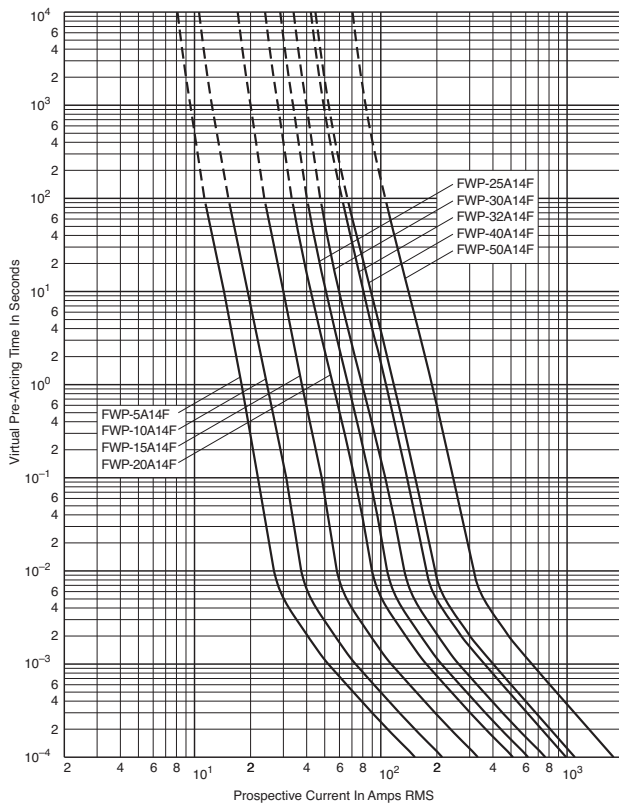

Peak Let-Through Curve

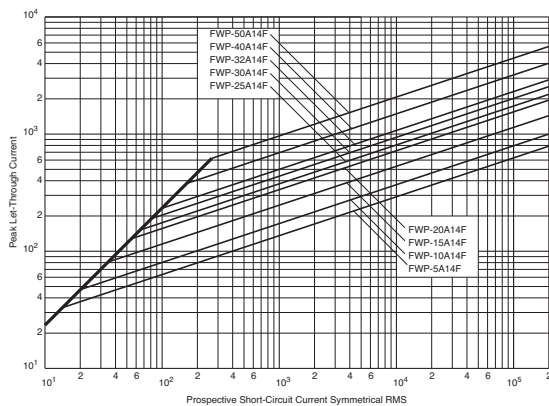

Data Sheet: 35785307

Ferrule — FWP 690V/700V (IEC/UL): 20-100A, Striker Optional

FWP (22 x 58mm)

Specifications

Description: Ferrule style high speed fuses with and without indicating striker.

Dimensions: See dimensions illustration.

Ratings:

- Volts: — 690Vac (IEC)
- 700Vac (UL)
- 500Vac
- 500Vdc (20-100A)
- Amps: — 20-100A
- IR: — 200kA RMS Sym.
- 50kA @ 500Vdc

Agency Information: CE, UL Recognition JFHR2.E91958, CSA Component Acceptance file Class 1422-30, 1422-90 (53787)

Electrical Characteristics

Total Clearing I²t

The total clearing I²t at rated voltage and at power factor of 15% are given in the electrical characteristics. For other voltages, the clearing I²t is found by multiplying by correction factor, K, given as a function of applied working voltage, E_g, (rms).

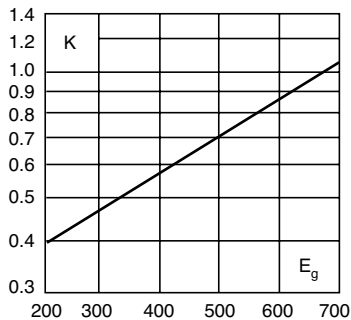

Dimensions - mm (in)

Without Striker

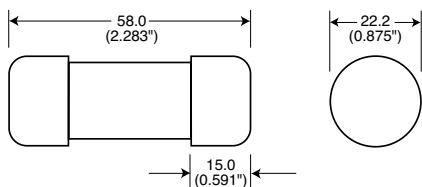

With Striker

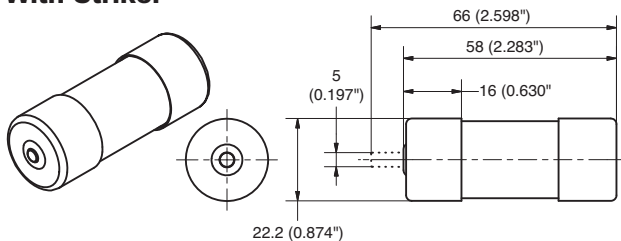

FWP with striker option.

Arc Voltage

This curve gives the peak arc voltage, U_L, which may appear across the fuse during its operation as a function of the applied working voltage, E_g, (rms) at a power factor of 15%.

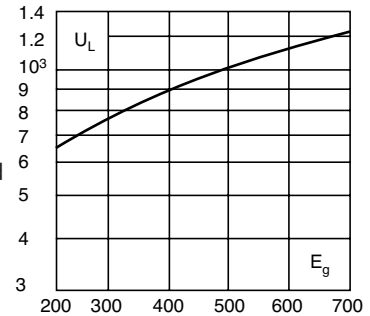

Power Losses

Watts loss at rated current is given in the electrical characteristics. The curve allows the calculation of the power losses at load currents lower than the rated current. The correction factor, K_p, is given as a function of the RMS load current, I_b, in % of the rated current.

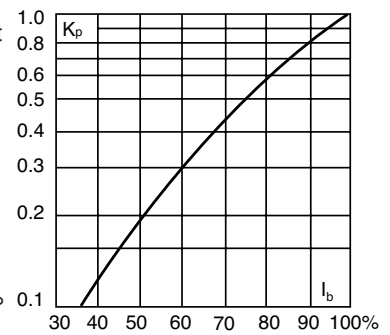

Catalog Numbers

Catalog Numbers	Size	Rated Current RMS-Amps	Electrical Characteristics		Watts Loss
			I ² t (A ² Sec)		
			Minimum Melting	Clearing At Rated Voltage	
Without Striker					
FWP-20A22F	22 x 58mm (⁷ / ₈ " x 2 ¹ / ₂ "	20	19.0	260	5
FWP-25A22F		25	34.0	410	6
FWP-32A22F		32	53.5	605	8
FWP-40A22F		40	68	750	9
FWP-50A22F		50	135	1600	9.5
FWP-63A22F		63	280	3080	11
FWP-80A22F		80	600	6600	13.5
FWP-100A22F	100*	1100	12500	16	
With Striker					
FWP-20A22FI	22 x 58mm (⁷ / ₈ " x 2 ¹ / ₂ "	20	19.0	260	5
FWP-25A22FI		25	34.0	410	6
FWP-32A22FI		32	53.5	605	8
FWP-40A22FI		40	68	750	9
FWP-50A22FI		50	135	1600	9.5
FWP-63A22FI		63	280	3080	11
FWP-80A22FI		80	600	6600	13.5
FWP-100A22FI	100*	1100	12500	16	

*IEC/UL Voltage rating 690/700

Features and Benefits

- Excellent cycling capability and DC performance
- Low arc voltage and low energy let-through (I²t)
- Low watts loss in a compact size
- Used with finger-safe holders/blocks

Typical Applications

- DC Common bus
- DC Drives
- Power converters/rectifiers
- Reduced voltage starters

Ferrule — FWP 690V/700V (IEC/UL): 20-100A, Striker Optional

Without Striker

FWP 20-100A: 660V/700V (22 x 58mm)

Time-Current Curve

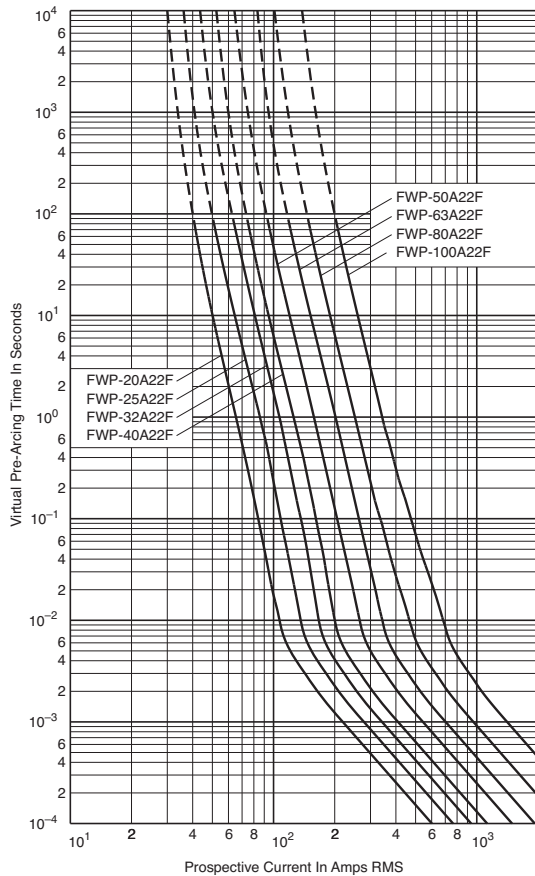

Peak Let-Through Curve

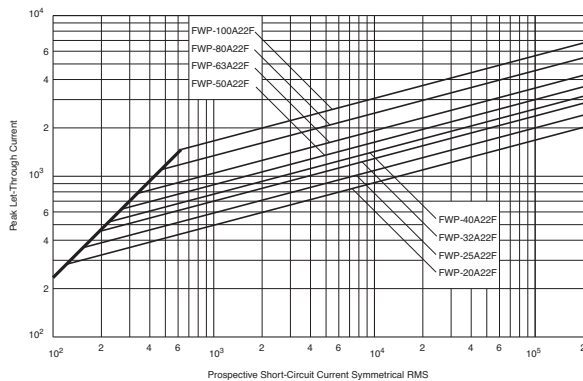

Data Sheet: 35785291

Ferrule — FWK 750V: 5-60A

FWK 5-30A (20 x 127mm) 35-60A (25 x 146mm)

Specifications

Description: Ferrule style high speed fuses.

Dimensions: See Dimensions illustrations.

Ratings:

Volts: — 750Vac

— 750Vdc (Time constant = 10-15mS)

Amps: — 5-60A

IR: — 45kA RMS Sym.

Agency Information: CE

Catalog Numbers

Catalog Numbers	Size	Electrical Characteristics		
		Rated Current RMS-Amps	I ² t (A ² Sec)	
			Pre-arc	Clearing at 750Vdc
FWK-5A20F	20 x 127mm (¹³ / ₁₆ " x 5")	5	8.5	16
FWK-8A20F		8	50	100
FWK-10A20F		10	95	200
FWK-15A20F		15	100	240
FWK-20A20F		20	125	315
FWK-25A20F		25	400	1100
FWK-30A20F	30	800	2600	
FWK-35A25F	25 x 146mm (1" x 5 ⁷ / ₁₆ ")	35	1300	4300
FWK-40A25F		40	1600	5300
FWK-50A25F		50	3100	12000
FWK-60A25F		60	5900	24000

Recommended fuseholders for 20x127, -2, -3
Recommended fuseclips for 20x127, 1A1837
Recommended fuseclips for 25x146, A3354705



Features and Benefits

- Excellent cycling capability and DC performance
- Low arc voltage and low energy let-through (I²t)
- Low watts loss in a compact size
- Used with finger-safe holders/blocks

Typical Applications

- DC Common bus
- DC Drives
- Power converters/rectifiers
- Reduced voltage starters

Dimensions - mm (in)

Fig. 1: 5-30A

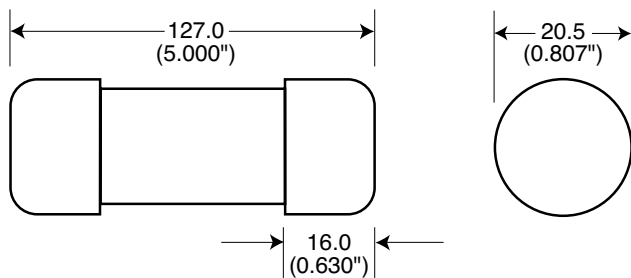
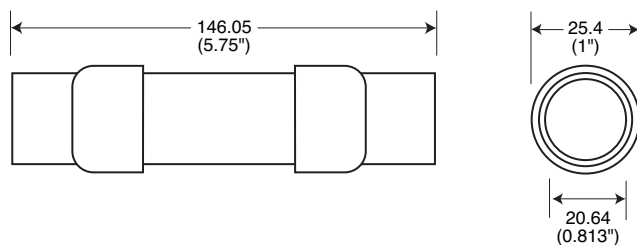

Fig. 2: 35-60A



Ferrule — FWK 750V: 5-60A

FWK 750V: 5-30A (20 x 127mm)
35-60A (25 x 146mm)

Time-Current Curve

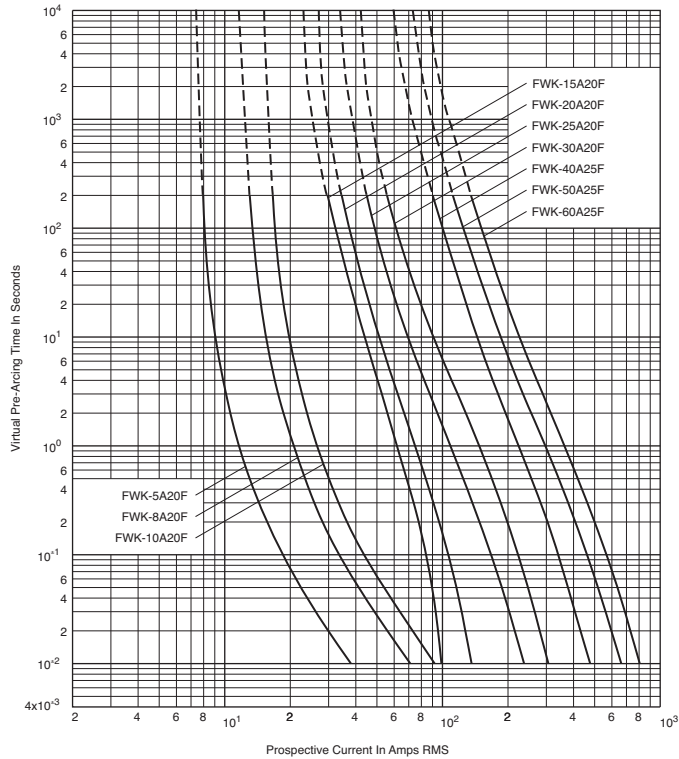

High Speed Fuses

Ferrule — FWJ 1000V: 20-30A

FWJ (14 x 67mm)

Specifications

Description: Ferrule style high speed fuses.

Dimensions: See dimensions illustration.

Ratings:

Volts: — 1000Vac/800Vdc

Amps: — 20-30A

IR: — 25kA RMS Sym.

— 20kA @ 800Vdc

Agency Information: CE, UL Recognized JFHR2.E91958

Electrical Characteristics

Total Clearing I²t

The total clearing I²t at rated voltage and at power factor of 15% are given in the electrical characteristics. For other voltages, the clearing I²t is found by multiplying by correction factor, K, given as a function of applied working voltage, E_g, (rms).

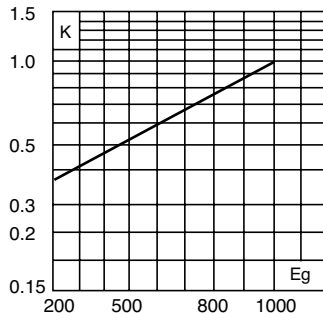

Dimensions - mm (in)

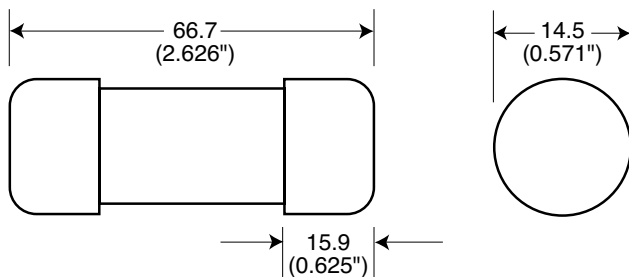

Fuseclips:

- Catalog Number: 5591 (see data sheet 2132)

Arc Voltage

This curve gives the peak arc voltage, U_L, which may appear across the fuse during its operation as a function of the applied working voltage, E_g, (rms) at a power factor of 15%.

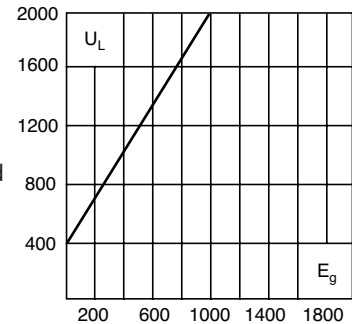

Power Losses

Watts loss at rated current is given in the electrical characteristics. The curve allows the calculation of the power losses at load currents lower than the rated current. The correction factor, K_p, is given as a function of the RMS load current, I_b, in % of the rated current.

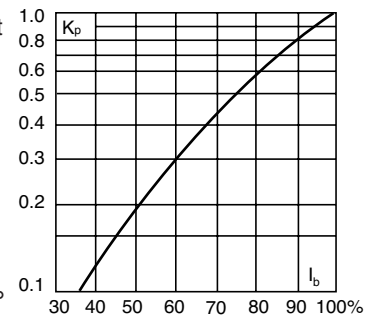

Catalog Numbers

Catalog Numbers	Size	Electrical Characteristics			
		Rated Current RMS-Amps	I ² t (A ² Sec)		Watts Loss
			Pre-arc	Clearing at 1000V	
FWJ-20A14F	14 x 67mm	20	25	220	9
FWJ-25A14F	($\frac{1}{8}$ " x $\frac{1}{2}$ ")	25	33	350	11
FWJ-30A14F		30	52	450	14

• Watts loss provided at rated current.

• See accessories on page 243.

Features and Benefits

- Excellent cycling capability and DC performance
- Low arc voltage and low energy let-through (I²t)
- Low watts loss in a compact size
- Used with finger-safe holders/blocks

Typical Applications

- DC Common bus
- DC Drives
- Power converters/rectifiers
- Reduced voltage starters

Ferrule — FWJ 1000V: 20-30A

FWJ 20-30A: 1000V (14 x 67mm)

Time-Current Curve

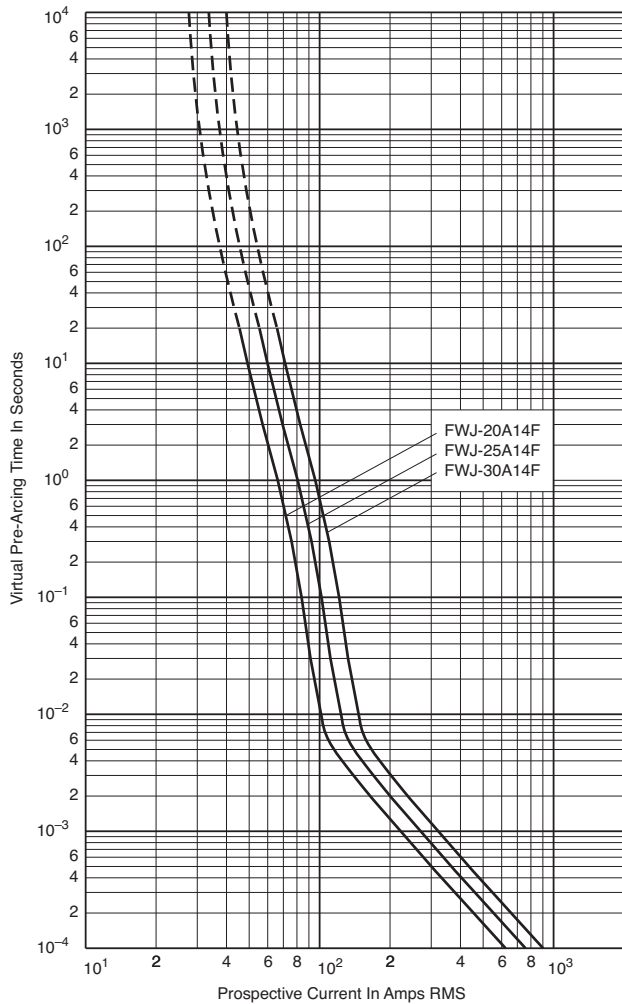

Peak Let-Through Curve

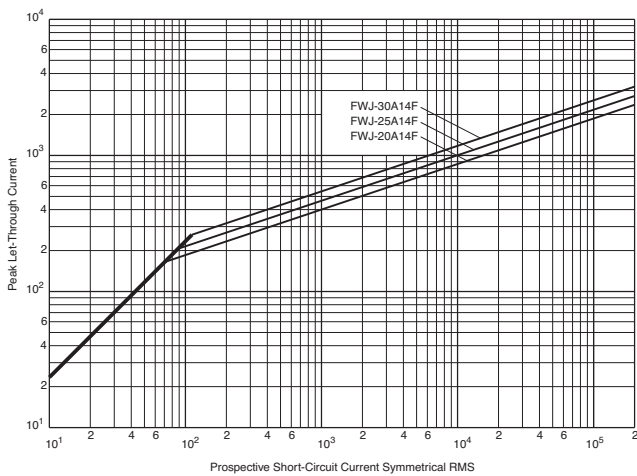

Data Sheet: 35785315

Ferrule — FWS/FWL 1000Vdc: 2-30A

FWS 2-15A (20 x 127mm)
FWL 20-30A (20 x 127mm)

Specifications

Description: Ferrule style full range fuses.

Dimensions: See dimensions illustrations.

Ratings:

- Volts: — 1200Vac (FWL 20-30A)
- 1400Vac (FWS 8-15A)
- 2100Vac (FWS 2-6A)
- 1000Vdc (FWL/FWS 2-30)

Amps: — 2-30A

- IR: — 45kA RMS Sym.
- 30kA @ 1000Vdc

Agency Information: CE, IEC 60077

Catalog Numbers

Catalog Numbers	Size	Electrical Characteristics				Watts Loss
		Rated Current RMS-Amps	I ² t (A ² Sec)		Clearing at 1000Vdc	
			Pre-arc			
FWS-2A20F	20 x 127mm (¹³ / ₁₆ " x 5")	2	0.8	2.4	4.4	
FWS-6A20F		6	27	81	6.7	
FWS-8A20F		8	64	192	7.6	
FWS-10A20F		10	118	277	3.0	
FWS-12A20F		12	170	380	3.4	
FWS-15A20F	15	209	500	5.0		
FWL-20A20F	20 x 127mm (¹³ / ₁₆ " x 5")	20	675	1550	5.9	
FWL-25A20F		25	1200	2760	6.5	
FWL-30A20F		30	1850	4300	7.5	

- ADD "I" to catalog number for indicating version.
- Enclosed finger-safe fuse holder – CH127
- See accessories on page 243.
- Watts loss provided at rated current.

Dimensions - mm (in)

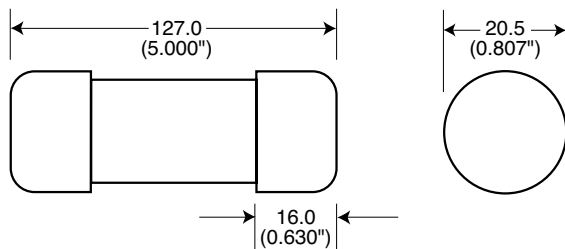

Indicating Version - Dimensions - mm (in)

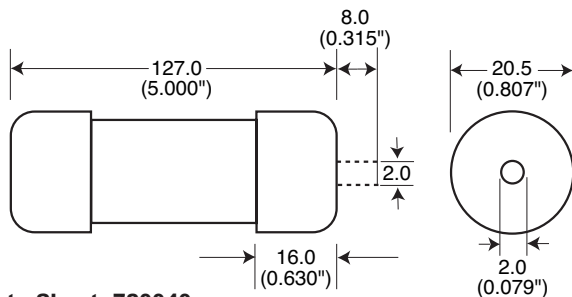

Data Sheet: 720040



Features and Benefits

- Excellent cycling capability and DC performance
- Low arc voltage and low energy let-through (I²t)
- Low watts loss in a compact size
- Used with finger-safe holders/blocks

Typical Applications

- DC Common bus
- DC Drives
- Power converters/rectifiers
- Reduced voltage starters
- Traction aux circuits
- Capacitor protection

FWL/FWS 2-30A: 1000Vdc 2-30A (20 x 127mm)

Time-Current Curve

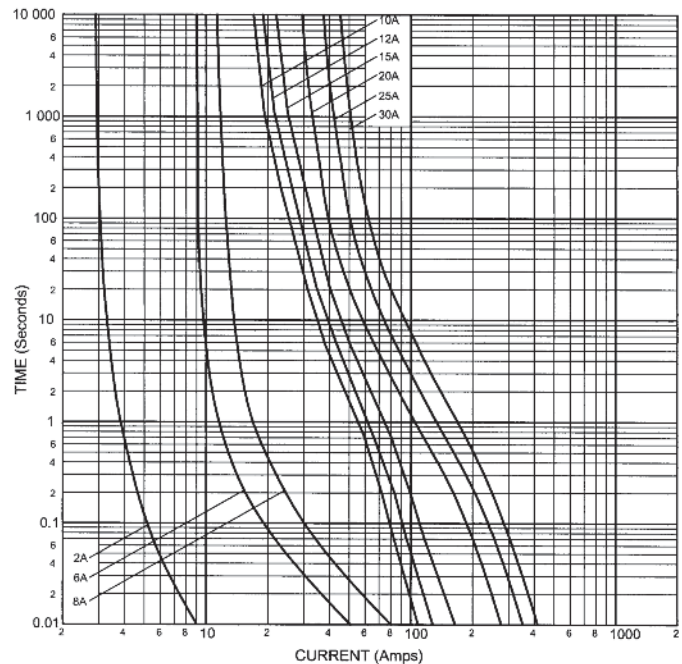

Ferrule Fuse Accessories

Fuse Holders

Specifications

Catalog Symbol: CH Series

Description: DIN-Rail mount fuse holders

Agency Information:

UL File E14853, Guide IZLT Listed, IZLT2 Recognized
CSA: File 47235, CHPV and CHM - Class 6225-30,
CHCC - Class 6225-01

Ratings: 600V/30A (UL)
690V/32A (IEC)

Features and Benefits

- Finger-safe design - No exposed contacts
- DIN-Rail mount (35mm) - Fits standard mounting rails
- Optional open fuse indication lights tells fuse status at a glance
- Handle/fusepuller easily installs and removes fuses
- Available in single and multi-pole configurations
- Wire ready lugs and spade terminal connections save installation time
- CE marking
- Available up to 1000Vdc
- PLC device available for remote monitoring

Typical Applications

- Switchboard panel, control consoles, small motors, transformers, and similar applications

Recommended Cooper Bussmann Fuse Types

Class CC North American Class CC Fuses - LP-CC, FNQ-R, KTK-R

10 x 38 North American Midget Fuses - FNQ, KTK, AGU, BAF, BAN, FNM, FWA, FWC, & PV

14 x 51 FWX, FWH, FWP & NON

22 x 58 FWP

See pages 274-280 for CH Series fuse holder information.



Fuse Blocks

Specifications

Catalog Symbol: J70100, J70032

Description: Fuse blocks for 22x58mm & 14x51mm fuses.

Ratings:

Volts: — 700Vac/dc
Amps: — 32-100A
Withstand: — 200kA RMS Sym.

Agency Information: CE, UL Recognized, Guide IZLT2, File E14853

Flammability Rating: UL 94V0



Catalog Numbers

Catalog Numbers	Fuse Size	Amps	Poles	Max Wire Size	Terminations
J70032-1CR	14x51	32	1	#2	Box Lug w/ Retaining Clip
J70032-2CR		32	2	#2	
J70032-3CR		32	3	#2	
J70100-1CR	22x58	100	1	#2	
J70100-2CR		100	2	#2	
J70100-3CR		100	3	#2	

High speed fuses



Faster lead-time.
Better protection.
More energy efficient.

Bussmann
by **EAT·N**

IEC and British Standard Fuses

Section Contents

	Page
Application Data	245-246
CSA Type P and Type D fuses (CDS, CDN & PON)247
Tron™ HRC Form II Class C fuses (CGL Form II Class C)	248
HRCI Industrial ceramic body fuses (CIF21 HRCI-CA & CIF06 HRCI-CB)	249
HRCI-J Fast-acting fuses (CJ HRCI-J)	250
HRCI-Miscellaneous Type K fuses (CIH, CIK & CIL HRCI-MISC)	251
HRC Form II current-limiting fuses252
BS 88 British Standard low voltage fuses (SSD, NSD, ESD & STD, NITD, AAO, BAO, OSD, CEO, DEO BS 88 Part 1)253
BS 88 British Standard low voltage fuses (AC, AD, BC, BD, CD, DD, ED, EFS & EF, FF, FG, GF, GG, GH BS 88)254
DIN Style Type D (D16, D27, D33, D125 Type D)255
Neozed low voltage fuses (NZ01, NZ02 Type D0)255
NH HRC Fuses	256-259
Class gG/gL IEC Industrial ferrule fuses (C08G, C08M, C10G, C10M, C14G, C14M, C22G, C22M)	260
Class aM IEC Industrial ferrule fuses (C08M, C10M, C14M, C22M)261
Class aM & gG/gL IEC Industrial ferrule fuses with striker (C14G_S, C22G_S, C14M_S, C22M_S)	262
HRC fuse holders	
CAMaster263
SAFEloc263



Scan this tag to get the
latest product information for
IEC and British Standard Fuses.

Application Data

The standard range of fuses for low voltage industrial and general purpose applications meet the requirements of BS 88 and IEC 60269. By using advanced fuse technology, current ratings up to 400A have compact dimensions, but retain standard dimensional and performance requirements. These designs are for 315/240V systems. The standard range of fuses are available from 2-1250A in the following tag forms: Offset Blade - Offset Bolted - Center Bolted.

Supplementary ranges cover applications up to 660Vac and 500Vdc including those with nonstandard tag fixings.

Bussmann fuses are manufactured under quality systems independently assessed to BS 5750 (ISO 9002) and appropriate ratings carry the ASTA 20 endorsement.

Selecting fuses is relatively simple and effective. The following notes cover the majority of applications. For further information contact our Application Engineers at toll free phone: 855-287-7626 (855-BUSSMANN).

Circuit Loading

The current rating of the fuse should not be less than the full load current of the circuit. The circuit should be so designed that small overloads of long duration will not be of frequent occurrence.

Cable Ratings & Protection

There is an increasing move away from 70°C PVC insulation to materials that are more environmentally friendly, for example 90°C XLPE. The ratings of fusegear, switches, accessories, etc. are generally based upon the equipment being connected to conductors intended to be operated at a temperature not exceeding 70°C in normal service.

In view of the above, it is recommended that the practice of designs based upon conductor temperatures of 70°C be regarded as the norm. The equipment manufacturer should be consulted to ascertain the reduction of nominal current rating of the equipment if conductor temperatures exceeding 70°C are used. In addition, an overriding factor is often voltage drop.

Fuses with gG characteristics protect associated cables against both overload and short-circuit current, provided that the current rating of the fuse 1_N is equal or less than the current carrying capacity of the cable 1_Z .

In motor circuits, the motor starter will provide the overload protection and the fuses will provide the short-circuit protection. The maximum fuse size that can be used depends upon the type of cable used and is determined using the appropriate K factor. The following table gives the maximum sizes of fuses that are recommended for two popular cables with copper conductors, 70°C PVC (K = 115) and 90°C thermosetting (K = 143).

Application Data for BS Low Voltage Fuses

Cable Size (mm ²)	Max. Fuse Rating (amps)	
	K = 115	K = 143
1	16	16
1.5	20	25*
2.5	32*	32*
4	50*	50*
6	63*	63*
10	100*	125*
16	125*	160*
25	200*	250*
35	315*	355*
50	400*	500
70	560	630
95	710	800
120	800	1000

* Extended Motor Circuit dual ratings can be used.

Protection Against Electrical Shock

For a TN System, a disconnecting time not exceeding 5s is permitted for a distribution circuit. The maximum values of earth fault loop impedance (Zs) of 240V for Bussmann gG fuses to BS 88: Parts 2 and 6 are:

Rating (A)	Zs (Ohms)	Rating (A)	Zs (Ohms)	Rating (A)	Zs (Ohms)
6	14	50	1.1	250	0.16
10	7.7	63	0.86	315	0.13
16	4.3	80	0.60	400	0.096
20	3.0	100	0.44	500	0.073
25	2.4	125	0.35	630	0.054
32	1.9	160	0.27	800	0.044
40	1.4	200	0.20		

Ambient Temperature

The derating, in terms of current, of 0.5% per °C above an ambient of 35°C is recommended.

Interrupting Rating

The standardized interrupting rating values are 80kA for voltages of 415Vac and above, and 40kA for DC applications. The 240Vac designs have an interrupting rating of 50kA.

Coordination Ratio

All fuses to BS 88 Parts 2 and 6 will give a coordination ratio of 2:1; and for most practical situations a ratio of 1.6:1 (two steps in the R10 series). Example: an upstream fuse rated at 160A will coordinate with a downstream fuse rated at 100A.

Current and Energy Limitation

The range of fuses have pre-arcing I²t values towards the bottom limits of BS 88 Parts 2 and 6. This ensures excellent current and energy limitation. They also have lower power losses at rated current. This assists in the appropriate interchangeability with other makes of fuses.

Transformers

When fuses are used on the primary side of transformers, the normal fuse current rating should be at least twice the nominal transformer primary current.

Fluorescent Lighting

The normal fuse current rating should be at least twice the normal full load current of the maximum number of lights to be simultaneously switched.

Capacitor Circuits

For power factor correction in capacitor circuits, the fuse should be chosen with a current rating greater than 1.5 times the rated capacitor current. This takes into account the high inrush current, circuit harmonics and capacitor tolerances.

Motor Circuits

In motor circuits, the fuse has to withstand the motor's starting current and often requires a higher rating than the motor's full load current. Coordination recommendations are made by the manufacturers of motor starters in accordance with IEC 60947-4-1. To get Type 2 coordination with fuses, tests are performed with the latest gG or gM fuses to BS 88 or IEC 60269 that have pre-arcing I²t values towards the bottom of specified limits. This means that Bussmann fuses are suitable to provide Type 2 coordination.

Extended dual ratings of motor circuit protection fuses with gM characteristics are available in most popular fuse sizes to extend the use of associated equipment with appropriate economies. In the majority of applications, gG fuses are used. It is not essential to use gM fuses for motor circuit protection, they simply extend the utilization of standard equipment.

Below is a table of recommended fuses at 415V. In most applications, the run-up time is less than 5 seconds and duty is infrequent - no more than twice per hour. The next larger rating should be used for more demanding applications.

Rating Motor		Direct On-line		Asst. Start Standard (gG)
		Standard (gG)	Motor Circuit (gM)	
kW	A	A	A	A
0.25	0.8	4	-	2
0.37	1.1	4	-	2
0.55	1.5	6	-	4
0.75	2.0	6	-	4
1.1	3.0	10	-	6
1.5	3.6	16	-	0 1
2.2	5.0	16	-	0 1
3.0	6.5	20	-	6 1
4.0	8.4	20	-	6 1
5.5	11.0	25	20M25	2 20
7.5	15.0	40	32M40	25
11.0	20.0	50	32M50	32
15.0	27.0	63	32M63	40
18.5	33.0	80	63M80	50
22.0	38.0	80	63M80	50
30.0	54.0	100	63M100	80
37.0	66.0	125	100M125	80
45.0	79.0	160	100M160	100
55.0	98.0	160	100M160	100
75.0	135.0	250	200M250	160
90.0	155.0	250	200M250	160
110.0	185.0	315	200M315	200
132.0	220.0	355	315M400	250
150.0	250.0	355	315M400	315
185.0	310.0	450	400M500	355
200.0	335.0	500	4 00M500	400
225.0	375.0	560	-	400
250.0	415.0	560	-	450
280.0	460.0	630	-	500
335.0	562.0	710	-	630
355.0	596.0	800	-	710

CSA Type P and Type D Fuses

CDS, CDN & PON Type P & D

Specifications

Description: CSA time-delay Type D & P fuses.

Dimensions: See Catalog Numbers table and Dimensions illustration.

Ratings:

Volts: — 250Vac (CDN & PON)
— 600Vac (CDS)

Amps: — 10-600A

IR: — 10kA minimum

Agency Information: CE, CSA Certified to C22.2 No. 59.1.

Features and Benefits

- Economical fuse in a variety of ratings for applications not requiring time-delay.

Typical Applications

- Lighting, heating and other circuits not subject to temporary surges and where available short-circuit current are relatively low.

Basic Catalog Numbers

Time-Delay CSA Type “D” Fuses

Catalog Numbers	Volts	Amp Ratings
CDN	250Vac	Below 10A use FRN-R 10, 12, 15, 20, 25, 30, 35, 40, 45, 50, 60, 70, 80, 90, 100
		110, 125, 150, 175, 200, 225, 250, 300, 350, 400, 450, 500, 600
		Below 10A use FRS-R 10, 12, 15, 20, 25, 30, 35, 40, 45, 50, 60
		70, 80, 90, 100, 110, 125, 150, 175, 200,
		225, 250, 300, 350, 400, 450, 500, 600
CDS	600Vac	70, 80, 90, 100, 110, 125, 150, 175, 200, 225, 250, 300, 350, 400, 450, 500, 600

One-Time CSA Type “P” Fuses

Catalog Number	Volts	Amp Ratings
PON	250Vac	15, 20, 25, 30, 35, 40, 45, 50, 60



Dimensions

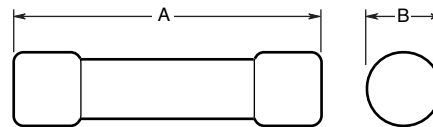

Ferrule Design—1 through 60A

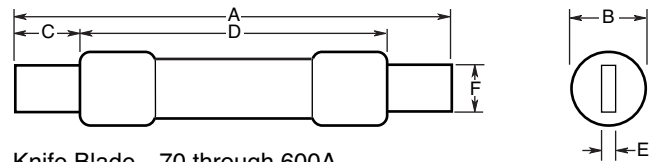

Knife Blade—70 through 600A

Catalog Numbers

Basic Catalog Number and Volts	Dimensions in (mm)						
	Amp Ratings	A Overall	B Max Diameter	C Min Blade Length	D Min Barrel Length	E Blade Thickness	F Blade Width
CDN/PON 250Vac	1-30	2.0 (50.8)	0.56 (14.3)	—	—	—	—
	35-60	3.0 (76.2)	0.81 (20.6)	—	—	—	—
	70-100	5.88 (149.4)	—	1.0 (25.4)	—	0.13 (3.2)	0.75 (19.1)
	110-200	7.3 (185.4)	—	1.38 (34.9)	4.13 (104.8)	0.19 (4.8)	1.13 (28.6)
	225-400	8.63 (219.2)	—	1.88 (47.6)	4.63 (117.5)	0.25 (6.4)	1.63 (41.3)
CDS 600Vac	450-600	10.38 (263.7)	—	2.25 (57.2)	5.19 (131.8)	0.25 (6.4)	2 (50.8)
	1-30	5.0 (127.0)	0.81 (20.6)	—	—	—	—
	35-60	5.5 (139.7)	1.06 (27.0)	—	—	—	—
	70-100	7.88 (200.2)	—	1.0 (25.4)	—	0.13 (3.2)	0.75 (19.1)
	110-200	9.63 (244.6)	—	1.38 (34.9)	6.13 (115.6)	0.19 (4.8)	1.13 (28.6)
	225-400	11.63 (295.4)	—	1.88 (47.6)	7.13 (118.1)	0.25 (6.4)	1.63 (41.3)
450-600	13.38 (339.9)	—	2.25 (57.2)	8.19 (208.0)	0.25 (6.4)	2 (50.8)	

To Order

To order, specify Basic Catalog Number and amp rating. Example: CDN-30

Data Sheet: 4126

Tron™ HRC Form II Class C Fuses

CGL Form II Class C

Specifications

Description: Current-limiting HRCII-C fuses designed to withstand inrush currents on typical motor start-ups while offering high current limitation in the short-circuit region.

Dimensions: See Dimensions illustrations.

Ratings:

Volts: — 600Vac/250Vdc (1-30A)

Amps: — 1-600A

IR: — 200kA (40,000A DC)

Agency Information: CE, CSA Certified, C22.2 No. 106.

Features and Benefits

- Close sizing to loads allows using smaller and less costly switches
- Provides a higher degree of short-circuit protection
- Helps protect motors against burnout from overloads

Typical Applications

- For use in circuits subject to surge currents such as those caused by motors, transformers and other inductive loads



Dimensions

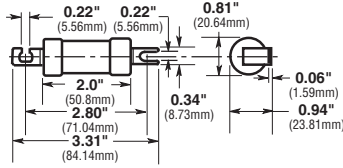

CGL 1-30

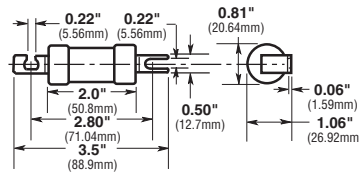

CGL 35-60

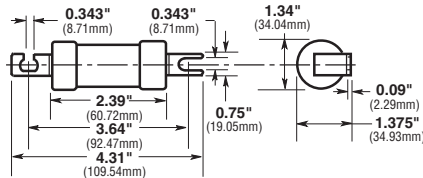

CGL 70-100

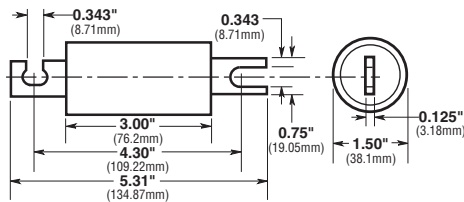

CGL 110-200

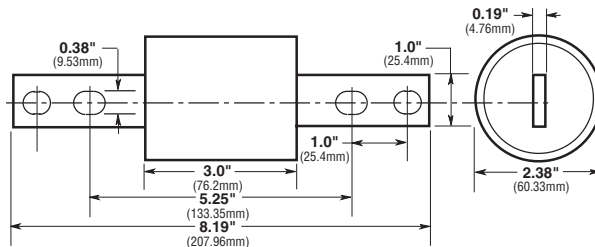

CGL 225-400

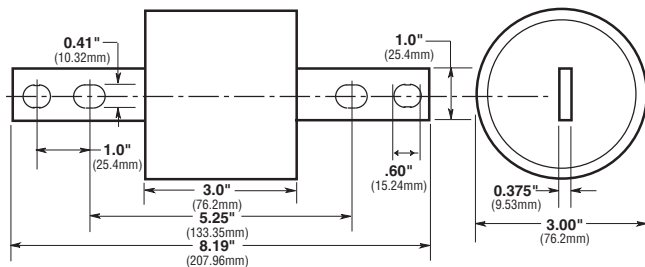

CGL 450-600

Catalog Numbers (-Amps)

CGL-1	CGL-40	CGL-175
CGL-2	CGL-45	CGL-200
CGL-3	CGL-50	CGL-225
CGL-4	CGL-60	CGL-250
CGL-6	CGL-70	CGL-300
CGL-10	CGL-80	CGL-350
CGL-15	CGL-90	CGL-400
CGL-20	CGL-100	CGL-450
CGL-25	CGL-110	CGL-500
CGL-30	CGL-125	CGL-600
CGL-35	CGL-150	

HRCI Industrial Ceramic Body Fuses

CIF21 HRCI-CA

Specifications

Description: The HRCI-CA fuse provides both overload and short-circuit protection to HRCI requirements. Offset blades for bolt-on mounting. CIF21 fuse fits the Cooper Bussmann CAMaster fuse holder (see data sheet 4132).

Dimensions: See Dimensions illustration.

Construction: Ceramic body.

Ratings:

Volts: — 600Vac/250Vdc

Amps: — 1-30A

IR: — 200kA RMS Sym.

Agency Information: CE, CSA C22.2, No. 106-M92.

Mounting: Bolt-on.

Catalog Numbers

Catalog Numbers	Amp Ratings
1CIF21	1
3CIF21	3
6CIF21	6
10CIF21	10
15CIF21	15
20CIF21	20
25CIF21	25
30CIF21	30

Features and Benefits

- Close sizing to loads allows using smaller and less costly switches
- Provides a higher degree of short-circuit protection
- Helps protect motors against burnout from overloads

Typical Applications

- For use in circuits subject to surge currents such as those caused by motors, transformers and other inductive loads

Dimensions - in (mm)

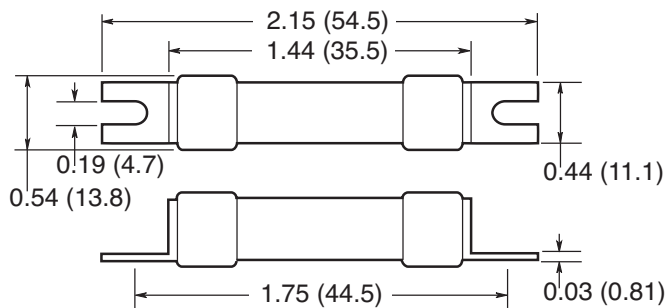

Data Sheet: 4127

CIF06 HRCI-CB

Specifications

Description: A miniature industrial fuse that provides both short-circuit and overload protection and the CIF06 fits the 30A SAFEloc fuse holder.

Dimensions: See Dimensions illustration.

Construction: Ground ceramic body with plated end caps.

Ratings:

Volts: — 600Vac/250Vdc

Amps: — 1-30A

IR: — 200kA RMS Sym.

Agency Information: CE, CSA C22.2 No. 106-M92 (3-30A only).

Mounting: Clip-in offset blades.

Catalog Number

Catalog Numbers	Amp Ratings
1CIF06	1
3CIF06	3
6CIF06	6
10CIF06	10
15CIF06	15
20CIF06	20
25CIF06	25
30CIF06	30

Features and Benefits

- Close sizing to loads allows using smaller and less costly switches
- Provides a higher degree of short-circuit protection
- Helps protect motors against burnout from overloads

Typical Applications

- For use in circuits subject to surge currents such as those caused by motors, transformers and other inductive loads

Dimensions - in (mm)

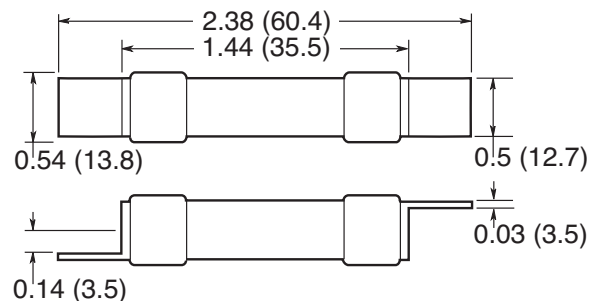

Data Sheet: 4128

HRCI-J Fast-acting Fuses

CJ HRCI-J

Specifications

Description: HRCI-J fast-acting fuses are industrial duty fuses with the excellent current-limiting characteristics of fast-acting HRCI-J fuses to limit damage to equipment and installations by the thermal and magnetic energy associated with a large short-circuit fault current. Overload characteristics limit cable damage due to low overload currents.

Dimensions: See Catalog Numbers table and Dimensions illustrations.

Construction: Ceramic body fuse.

Ratings:

Volts: — 600Vac (or less), 250Vdc

Amps: — 1-600A

IR: — 200kA

Agency Information: CSA C22.2 No. 106 M92; Designed to BS 88:2, IEC 60269-2.



Dimensions

1CJ to 60CJ

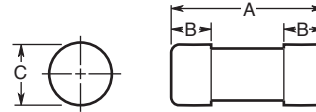

70CJ to 600CJ

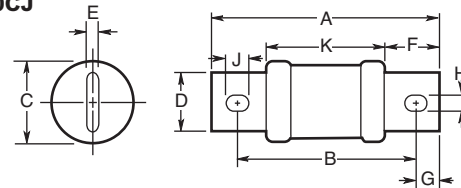

Catalog Numbers

Catalog Numbers	Amp Ratings	Dimensions - in (mm)									
		A	B	C	D	E	F	G	H	J	K
1CJ	1										
3CJ	3										
6CJ	6										
10CJ	10										
15CJ	15	2.25 (57)	0.5 (12.7)	0.81 (20.6)	—	—	—	—	—	—	—
20CJ	20										
25CJ	25										
30CJ	30										
35CJ	35										
40CJ	40										
45CJ	45	2.38 (60)	0.63 (16)	1.06 (27)	—	—	—	—	—	—	—
50CJ	50										
60CJ	60										
70CJ	70										
80CJ	80	4.63 (117)	3.63 (92)	1.13 (28)	0.75 (19)	0.13 (3.2)	1 (25.4)	0.5 (12.7)	0.28 (7.1)	0.38 (9.5)	2.63 (67)
90CJ	90										
100CJ	100										
110CJ	110										
125CJ	125										
150CJ	150	5.75 (146)	4.38 (111)	1.63 (41)	1.13 (28.6)	0.19 (4.8)	1.38 (35)	0.69 (17.5)	0.28 (7.1)	0.38 (9.5)	3 (76)
175CJ	175										
200CJ	200										
225CJ	225										
250CJ	250										
300CJ	300	7.13 (181)	5.25 (133)	2.13 (54)	1.63 (41)	0.25 (6.3)	1.88 (47.6)	0.94 (24)	0.41 (10.3)	0.53 (13.5)	3.38 (86)
350CJ	350										
400CJ	400										
450CJ	450										
500CJ	500	8 (203)	6 (152)	2.63 (66)	2 (51)	0.38 (9.5)	2.13 (54)	1 (25.4)	0.53 (13.5)	0.69 (17.5)	3.75 (96)
600CJ	600										

Data Sheet: 4129

HRCI - Miscellaneous Type K Fuses

CIH, CIK & CIL HRCI-MISC

Specifications

Description: HRCI fuses provide both overload and short-circuit protection, featuring offset blades for bolt down mounting.

Dimensions: See Catalog Numbers table and Dimensions illustration.

Construction: Ceramic body.

Ratings:

Volts: — 600V

Amps: — 1-100A

IR: — 200kA@600V

Agency Information: CE, CSA C22.2 No. 106 M92.



Dimensions

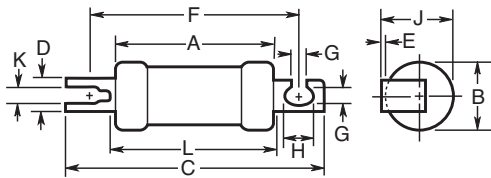

(The CIL14 has a rejection hole, not a slot as shown above.)

Catalog Numbers

Catalog Numbers	Amp Ratings	Dimensions - in (mm)										
		A Max	B Max	C Max	D Nom	E Nom	F Nom	G Nom	H Nom	J Max	K Nom	L Max
1CIH07	1	2.25 (57)	0.94 (24)	3.38 (86)	0.38 (9.2)	0.04 (1.0)	2.88 (73)	0.21 (5.2)	0.31 (8)	1 (25.4)	0.10 (2.6)	2.38 (60)
3CIH07	3											
6CIH07	6											
10CIH07	10											
15CIH07	15											
20CIH07	20											
25CIH07	25											
30CIH07	30	2.28 (58)	1.06 (27)	3.56 (91)	0.5 (12.7)	0.05 (1.2)	2.88 (73)	0.21 (5.2)	0.41 (10.5)	1.09 (28)	0.13 (3.2)	2.38 (61)
35CIK07	35											
40CIK07	40											
50CIK07	50											
60CIK07	60	2.75 (70)	1.44 (37)	4.38 (111)	0.75 (19)	0.09 (2.5)	3.69 (94)	0.34 (8.7)	0.41 (10.5)	1.5 (38.5)	—	2.91 (74)
80CIL14	80											
90CIL14	90											
100CIL14	100											

Recommended Fuse Holders

Fuse	Fuse Holder
1-30A	CM30CF
35-60A	CM60CF

HRC Form II Current-limiting Fuses

HRC Form II

Specifications

Description: HRC Form II current-limiting fuses.

Dimensions: See Catalog Numbers table and Dimensions illustrations.

Construction: Ceramic body.

Ratings:

Volts: — 600Vac (or less)
— 250Vdc

Amps: — 2-600A

IR: — 200kA RMS Sym.

Agency Information: CE, CSA C22.2 No.106M1992;
BS 88:2, IEC 60269:2.

Typical Applications

- Used to protect motor control circuits, together with contactors and overload protection relays to provide Type 2 coordination - per IEC 60947-4.



Dimensions

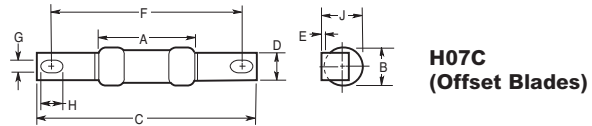

**H07C
(Offset Blades)**

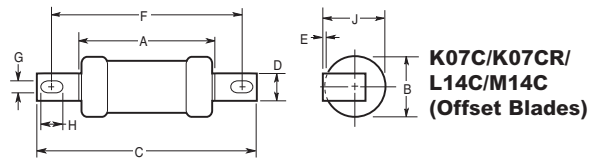

**K07C/K07CR/
L14C/M14C
(Offset Blades)**

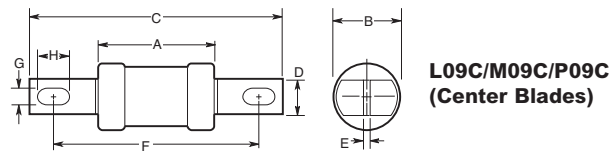

**L09C/M09C/P09C
(Center Blades)**

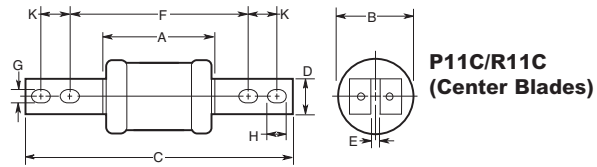

**P11C/R11C
(Center Blades)**

Catalog Numbers

Catalog Numbers	Amp Ratings	Dimensions - in (mm)										CSA Category											
		A	B	C	D	E	F	G	H	J	K												
2H07C	2	1.38 (35)	0.56 (14)	3.38 (85)	0.38 (9)	0.06 (1.2)	2.88 (73)	0.22 (5.6)	0.31 (8)	0.56 (14)	—	HRCII-C											
4H07C	4																						
6H07C	6																						
10H07C	10																						
15H07C	15																						
20H07C	20																						
25H07C	25																						
30H07C	30																						
40K07C	40																						
50K07C	50																						
60K07C	60	2.19 (56)	0.88 (22)	3.44 (87)	0.5 (13)	0.13 (3.2)	3.69 (94)	0.34 (8.7)	0.44 (11)	—	HRCII-C												
80K07CR	80			3.75 (95)																			
100K07CR	100									—	—	HRCII-MISC											
80L14C	80	2.38 (60)	0.88 (21.4)	4.38 (111)	0.56 (14.3)	0.13 (3.2)	3.69 (94)	0.34 (8.7)	0.44 (11)	1 (25.4)	—	HRCII-C											
100L14C	100				0.75 (19)																		
125M14C	125	2.56 (65)	1.5 (38)	5.38 (136)	0.75 (19)	0.09 (2.4)	4.38 (111)	0.34 (8.7)	0.44 (11)	—	—	HRCII-MISC											
150M14C	150																						
200M14C	200																						
80L09C	80												2.38 (60)	0.88 (21.4)	5 (127)	0.56 (14)	0.13 (3.2)	4.38 (111)	0.34 (8.7)	0.56 (14)	—	—	HRCII-C
100L09C	100																						
125M09C	125												2.56 (65)	1.5 (38)	5.38 (136)	0.75 (19)	0.13 (3.2)	4.38 (111)	0.34 (8.7)	0.56 (14)	—	—	HRCII-C
150M09C	150																						
200M09C	200																						
250P09C	250																						
300P09C	300																						
350P09C	350																						
400P09C	400																						
250P11C	250	3.06 (178)	2.31 (59)	8.25 (210)	1 (25.4)	0.19 (4.8)	5.25 (133)	0.41 (10)	0.63 (16)	—	1 (25)	HRCII-C											
300P11C	300																						
350P11C	350																						
400P11C	400																						
450R11C	450	3.19 (81)	2.88 (73)			0.25 (6.3)				—	1 (25)												
500R11C	500																						
600R11C	600																						

BS 88 British Standard Low Voltage Fuses

SSD, NSD, ESD BS 88 Part 1

Specifications

Description: The NSD and ESD are low voltage fuses complying with general purpose gG characteristics.

Construction: Ceramic body.

Ratings:

Volts: — 240-550Vac (See Catalog Numbers table)

Amps: — 2-63A (See Catalog Numbers table)
 — 20M25-63M100A Motor Starter ratings (See Catalog Numbers table)

IR: — 33kA (SSD)
 — 80kA (NSD, ESD)

Agency Information: CE, Meets the requirements of BS 88 Part 1 and IEC 60269-1.

Mounting: Offset blades.



Basic Catalog Numbers

Basic Catalog Numbers	Amp Ratings	Max AC Voltage Ratings	BS 88 Ref.
SSD	2, 4, 6, 10, 16, 20, 25, 32	240	E1
NSD	2, 4, 6, 10, 16, 20, 25, 32,	550	F1
	20M25*, 20M32*, 20M36*, 32M36*, 32M40*, 32M50*, 32M63*	415	F1
ESD	2, 4, 6, 10, 16, 25, 32	550	F2
	40, 50, 63, 63M80, 63M100*	415	F2

**M* indicates motor starter ratings.

To Order

To order, specify Basic Catalog Number and amp rating. Example: SSD-20

Recommended Fuse Holders

Basic Fuse Catalog Numbers	Holder Catalog Numbers
NSD	32NNSF
ESD	63ENSF

STD, NITD, AAO, BAO, OSD, CEO, DEO BS 88 Part 1

Specifications

Description: The STD to DEO types are low voltage fuses complying with general purpose gG characteristics.

Construction: Ceramic body.

Ratings:

Volts: — 240-550Vac (See Catalog Numbers table)

Amps: — 2-200A (See Catalog Numbers table)
 — 20M25-200M315A Motor Starter ratings (See Catalog Numbers table)

IR: — 33kA (STD)
 — 80kA (NITD, AAO, BAO, CEO, DEO)

Agency Information: CE, Meets the requirements of BS 88 Part 1 and IEC 60269-1.

Mounting: Offset bolted blades.



Typical Applications

- The STD type are used in 240V street lighting cut-outs
- NITD to DEO types used for industrial and general purpose applications

Basic Catalog Numbers

Basic Catalog Numbers	Amp Ratings	Max AC Voltage Ratings	BS 88 Ref.
STD	2, 4, 6, 10, 16, 20, 25, 32	240	—
NITD	2, 4, 6, 10, 16, 20, 25, 32	550	—
	20M25*, 20M32*, 32M40*, 32M50*, 32M63*	415	—
AAO	2, 4, 6, 10, 16, 20, 25, 32, 32M40*, 32M50*, 32M63*	550	—
BAO	40, 50, 63, 63M80*, 63M100*	550	A3
CEO	32, 40, 50, 63, 80, 100	550	A4
	100M125*, 100M160*, 100M200*	415	A4
DEO	125, 160, 200, 200M250*, 200M315*	415	—
OSD	80, 100	550	—
	100M125*, 100M160*	415	—

**M* indicates motor starter ratings.

To Order

To order, specify Basic Catalog Number and amp rating. Example: BAO-16

Recommended Fuse Blocks & Holders

Basic Fuse Catalog Numbers	Block/Holder Catalog Numbers
NITD	CM32FC
AAO	CM32F
BAO	CM63F
OSD	CM100F
CEO	BH-0111

Data Sheets 4123 (STD), 4106 (NITD), 4109 (AAO), 4112 (BAO), 4107 (OSD), 4115 (CEO) and 4117 (DEO)

Data Sheets 4105 (SSD), 4100 (NSD) and 4101 (ESD)

BS 88 British Standard Low Voltage Fuses

AC, AD, BC, BD, CD, DD, ED, EFS BS 88

Specifications

Description: Low voltage fuses that comply with general purpose gG characteristics and available up to 400A with two hole mount and up to 1250A with four hole mount.

Construction: Ceramic body.

Ratings:

Volts: — 415/550Vac, 250Vdc (See Catalog Numbers table)

Amps: — 2-400A (See Catalog Numbers table)
— 63M80-400M500A Motor Starter ratings (See Catalog Numbers table)

IR: — See Catalog Numbers table

Agency Information: CE, Meets the requirements of BS 88 Parts 1 and 2 and IEC 60269-1.

Mounting: Center bolted blades, two-hole mount.



Basic Catalog Numbers

Basic Catalog Numbers	Amp Ratings	Interrupting Ratings		Max Voltage Ratings		BS 88 Ref.
		AC	DC	AC	DC	
AC	2, 4, 6, 10, 16, 20, 25, 32	80kA	40kA	550	250	—
AD	2, 4, 6, 10, 16, 20, 25, 32	80kA	40kA	550	250	—
BC	40, 50, 63 63M80*, 63M100*	80kA	40kA	550	250	—
		80kA	—	550	—	—
BD	40, 50, 63	80kA	40kA	550	250	—
CD	80, 100, 100M125*, 100M160*, 100M200*, 100M200*	80kA	—	415	—	B1
DD	125, 160, 200, 200M250*, 200M315*	80kA	—	415	—	B2
ED	250, 315, 355, 400, 315M400*, 400M500*	80kA	—	415	—	B3
		80kA	—	550	—	B4
EFS	125, 160, 200, 250, 315	80kA	—	415	—	—

*"M" indicates motor starter ratings.

To Order

To order, specify Basic Catalog Number and amp rating. Example: BC-40

Recommended Fuse Blocks & Holder

Basic Fuse Catalog Numbers	Block/Holder Catalog Numbers
AC	BH-0111 Modular fuse block
AD	200DF Fuse holder
BC	BH-0111 Modular fuse block
BD	200DF-L
CD	200DF-L
DD	200DF-L
ED	BH-1131 Modular fuse block

Data Sheets 4110 (AC), 4111 (AD), 4113 (BC), 4114 (BD), 4116 (CD), 4118 (DD), 4119 (ED) and 4121 (EFS)

EF, FF, FG, GF, GG, GH BS 88

Specifications

Description: Low voltage fuses complying with general purpose gG characteristics and available up to 400A with two hole mount and up to 1250A with four hole mount.

Construction: Ceramic body.

Ratings:

Volts: — 415/550Vac, 250/400Vdc (See Catalog Numbers table for details)

Amps: — 355-1250

IR: — See Catalog Numbers table

Agency Information: CE, Meets the requirements of BS 88 Parts 1 and 2 and IEC269-1.

Mounting: Center bolted blades, four-hole mount.

Basic Catalog Numbers

Basic Catalog Numbers	Amp Ratings	Interrupting Ratings		Max Voltage Ratings		BS 88 Ref.
		AC	DC	AC	DC	
EF	355, 400 400M500*	80kA	—	415	—	C1
		80kA	—	550	—	—
FF	450, 500, 560, 630	80kA	40kA	550	400	C2
FG	450, 500, 560, 630	80kA	40kA	550	400	—
GF	710, 800	80kA	40kA	550	250	C3
GG	710, 800 1000, 1250	80kA	40kA	550	250	—
		80kA	—	550	—	—
GH	710, 800, 1000, 1250	80kA	—	550	—	—

*"M" indicates motor starter ratings.

To Order

To order, specify Basic Catalog Number and amp rating. Example: FG-450

Data Sheets 4120 (EF), 4102 (FF), 4122 (FG), 4103 (GF), 4104 (GG) and 4108 (GH)



DIN Style Type D and Neozed Low Voltage Fuses

D16, D27, D33, D125 Type D

Specifications

Description: DIN style Type D low voltage fuses.

Dimensions: See Catalog Numbers table and Dimensions illustrations.

Construction: Ceramic body.

Ratings:

- Volts: — 500Vac
- Amps: — 2-100A
- IR: — 100kA

Agency Information: CE, “D” type fuses complying with DIN 49360 Part 2 and DIN 49515, operating class gL.

Catalog Numbers

Catalog Numbers	Amp Ratings	Dimension “D” (mm)	Color Code	Figure Number
2D16	2	6	Pink	1
4D16	4	6	Brown	
6D16	6	6	Green	
10D16	10	8	Red	
16D16	16	10	Grey	
20D16	20	12	Blue	
25D16	25	14	Yellow	
2D27	2	6	Pink	2
4D27	4	6	Brown	
6D27	6	6	Green	
10D27	10	8	Red	
16D27	16	10	Grey	
20D27	20	12	Blue	
25D27	25	14	Yellow	
35D33	35	16	Black	3
50D33	50	18	White	
63D33	63	20	Copper	
80D125	80	5	Silver	4
100D125	100	7	Red	

Additional Fuse links: Quick acting fuselinks in body sized D16, D27, D33 and D125 rated 2-100A. Reference number suffixed Q, i.e. 10D27Q. Voltage rating 500V. Gauge rings and keys can also be supplied.

Dimensions - mm

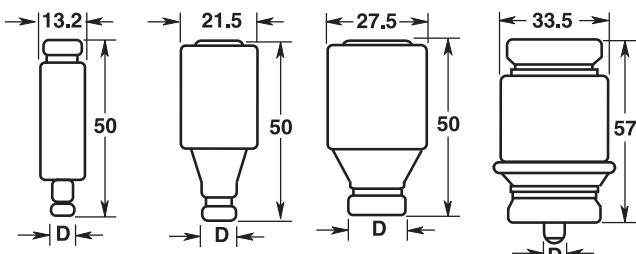

Figure 1

Figure 2

Figure 3

Figure 4

Data Sheet: 4124

NZ01, NZ02 Type D0

Specifications

Description: Low voltage Neozed fuses suitable for use on 250Vdc systems.

Dimensions: See Catalog Numbers table and Dimensions illustration.

Construction: Ceramic body.

Ratings:

- Volts: — 400Vac
- Amps: — 2-63A
- IR: — 100kA

Agency Information: CE

Catalog Numbers

Catalog Numbers	Amp Ratings	Dimension “D” (mm)	Color Code
2NZ01	2	11	Pink
4NZ01	4	11	Brown
6NZ01	6	11	Green
10NZ01	10	11	Red
16NZ01	16	11	Grey
20NZ02	20	15	Blue
25NZ02	25	15	Yellow
35NZ02	35	15	Black
50NZ02	50	15	White
63NZ02	63	15	Copper

Dimensions - mm

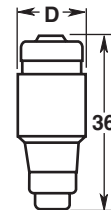

Data Sheet: 4124

NH HRC Fuses

NHG B

Specifications

Class: gG/gL

Description: DIN square bodied, dual indication industrial fuses.

Construction: Steatite insulator, corrosion-proof (aluminum) metal parts with full-contact, silver-plated copper blades.

Sizes: DIN 000 to 4.

Selectivity Ratio: 1:1.6 up to 500Vac.



Ratings:

Volts: — 500Vac/250Vdc

— 690Vac/250Vdc

Amps: — 2-1250A

IR: — 120kA

Frequency: — 50Hz

Operating Frequency: — 45-62Hz

Agency Information: IEC 60269, VDE0636, DIN 43620 Part 1 to 4, VDE Mark and CE.

Fuse Blocks	Size
SB00-D	000-00
SB1-D	1*, 1
SB2-D	02, 2, 03, 3

Dimensions - mm

Fuse Size	a ¹	a ² (max)	a ³	a ⁴	b (nom)	c ¹ (± 8)	c ² (nom)	D (nom)	e ¹ (max)	e ² (max)	e ³ (max)	e ⁴ (nom)	f (max)
000	78.5 ± 1.5	54	45 ± 1.5	49 ± 1.5	15	35	10	2 ± 0.5	41	21	16	6	8
00	78.5 ± 1.5	54	45 ± 1.5	49 ± 1.5	15	35	11	7.0 ± 0.5	48	30	25	6	15
0	125 ± 2.5	68	62 +3/-1.5	68 +1.5/-3	15	35	11	2.5 ± 0.5	48	30	25	6	15
01	135 ± 2.5	75	62 ± 2.5	68 ± 2.5	15	40	11	2.5 ± 0.5	48	30	25	6	15
1	135 ± 2.5	75	62 ± 2.5	68 ± 2.5	20	40	11	2.5 ± 0.5	53	52	25	6	15
02	150 ± 2.5	75	62 ± 2.5	68 ± 2.5	20	48	11	2.5 ± 0.5	53	52	25	6	15
2	150 ± 2.5	75	62 ± 2.5	68 ± 2.5	25	48	11	2.5 ± 0.5	61	60	25	6	15
03	150 ± 3	75	62 ± 2.5	68 ± 2.5	25	60	11	2.5 ± 0.5	61	60	25	6	15
3	150 ± 3	75	62 ± 2.5	68 ± 2.5	32	60	11	3.0 ± 0.5	75	70	25	6	18
4	200	84	80	90	50	85	11	3	120	87	—	8	30

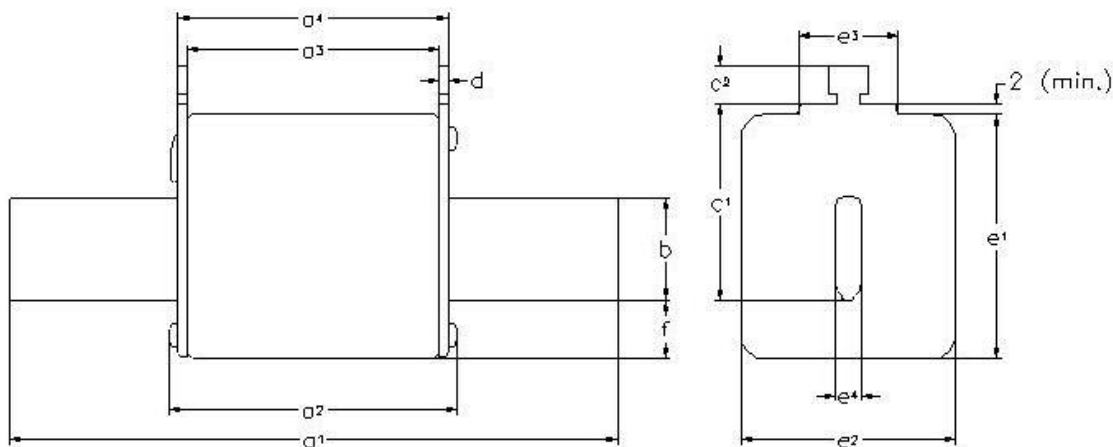



NH HRC Fuses

500Vac / 250Vdc	Size	Rated Current (Amps)	gG/gL Dual Indicator Voltage Conducting Metal Gripping Lugs	Carton Quantity
		2	2NHG00B	3
		4	4NHG00B	3
		6	6NHG00B	3
		10	10NHG00B	3
		16	16NHG00B	3
		20	20NHG00B	3
		25	25NHG00B	3
		32	32NHG00B	3
		35	35NHG00B	3
		40	40NHG00B	3
		50	50NHG00B	3
		63	63NHG00B	3
		80	80NHG00B	3
		100	100NHG00B	3
		125	125NHG00B	3
		160	160NHG00B	3
		10	10NHGOB	3
		16	16NHGOB	3
		20	20NHGOB	3
		25	25NHGOB	3
		32	32NHGOB	3
		35	35NHGOB	3
		40	40NHGOB	3
		50	50NHGOB	3
		63	63NHGOB	3
		80	80NHGOB	3
		100	100NHGOB	3
		125	125NHGOB	3
		160	160NHGOB	3
		10	10NHG01B	3
		16	16NHG01B	3
		20	20NHG01B	3
		25	25NHG01B	3
		32	32NHG01B	3
		35	35NHG01B	3
		40	40NHG01B	3
		50	50NHG01B	3
		63	63NHG01B	3
		80	80NHG01B	3
		100	100NHG01B	3
		125	125NHG01B	3
		160	160NHG01B	3
		200	200NHG1B	3
		224	224NHG1B	3
		250	250NHG1B	3
		35	35NHG02B	3
		40	40NHG02B	3
		50	50NHG02B	3
		63	63NHG02B	3
		80	80NHG02B	3
		100	100NHG02B	3
		125	125NHG02B	3
		160	160NHG02B	3
		200	200NHG02B	3
		224	224NHG02B	3
		250	250NHG02B	3
		315	315NHG2B	3
		355	355NHG2B	3
		400	400NHG2B	3
		250	250NHG03B	3
		315	315NHG03B	3
		355	355NHG03B	3
		400	400NHG03B	3
		500	500NHG3B	3
		630	630NHG3B	3
		500	500NHG4G	1
		630	630NHG4G	1
		800	800NHG4G	1
		1000	1000NHG4G	1
		1250	1250NHG4G	1
	Single Indicator			
	Slotted End			
	Tags			



NH HRC Fuses

690Vac / 250Vdc	Size	Rated Current (Amps)	gG/gL Dual Indicator Voltage Conducting Metal Gripping Lugs	Carton Quantity	
	000	2	2NHG000B-690	3	
		4	4NHG000B-690	3	
		6	6NHG000B-690	3	
		10	10NHG000B-690	3	
		16	16NHG000B-690	3	
		20	20NHG000B-690	3	
		25	25NHG000B-690	3	
		32	32NHG000B-690	3	
		35	35NHG000B-690	3	
		40	40NHG000B-690	3	
	0	50	50NHG00B-690	3	
		63	63NHG00B-690	3	
		80	80NHG00B-690	3	
		100	100NHG00B-690	3	
		6	6NHGOB-690	3	
		10	10NHGOB-690	3	
		16	16NHGOB-690	3	
		20	20NHGOB-690	3	
		25	25NHGOB-690	3	
		32	32NHGOB-690	3	
	0	35	35NHGOB-690	3	
		40	40NHGOB-690	3	
		50	50NHGOB-690	3	
		63	63NHGOB-690	3	
		80	80NHGOB-690	3	
		100	100NHGOB-690	3	
		50	50NHG1B-690	3	
		63	63NHG1B-690	3	
		80	80NHG1B-690	3	
		100	100NHG1B-690	3	
<td>125</td> <td>125NHG1B-690</td> <td>3</td>	125	125NHG1B-690	3		
	160	160NHG1B-690	3		
	200	200NHG1B-690	3		
	1	63	63NHG2B-690	3	
		80	80NHG2B-690	3	
		100	100NHG2B-690	3	
		125	125NHG2B-690	3	
		2	160	160NHG2B-690	3
			200	200NHG2B-690	3
			224	224NHG2B-690	3
250			250NHG2B-690	3	
3			315	315NHG2B-690	3
			250	250NHG3B-690	3
	315		315NHG3B-690	3	
	355		355NHG3B-690	3	
	400		400NHG3B-690	3	
	425		425NHG3B-690	3	
	500	500NHG3B-690	3		

NH Fuse Bases

SB*-D, SB*-S
Up to 690V / 160 - 1250A
Sizes 00, 0, 1, 2, 3, 4



Description: NH fuse bases with thermoplastic bodies. DIN-Rail and screw mounting (size 4 screw fix). Range of protection accessories for live parts in order to obtain IP20 protection standard.

Ratings:

- Volts: up to 690Vac
- Amps: 2 to 1250A

Applications: Protection of industrial circuits and electrical apparatus

Standards and Approvals: IEC 60269, DIN 43620

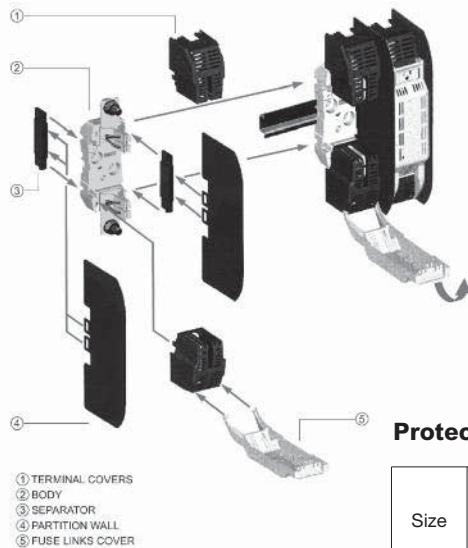

Part Numbers

Size	Poles	Current (Amps)	Part Numbers	Carton Quantity	Compatible Fuse Size
			DIN Screw		
00	1	160A	SB00-D	3	000 & 00
	3		TB00-D TB00-D-IP20	1	
0	1	160A	SB0-D	3	0
	3		TB0-D	1	
1	1	250A	SB1-D	3	01 & 1
	3		TB1-D	1	
2	1	400A	SB2-D	3	02 & 2
	3		TB2-D	1	
3	1	630A	SB3-D	3	03 & 3
	3		TB3-D	1	
4	1	1250A	SB4-S (Screw Connection only)	3	4

Neutral

Size	Current (Amps)	Part Ref	Carton Quantity
NH00	160	SL00	3
NH0	160	SL0	
NH1	250	SL1	
NH2	400	SL2	
NH3	630	SL3	
NH4	1000	SL4	



Fuse extraction handle

Size	Part Ref	Carton Quantity
C00-3	FEH	1



Protection accessories

Size	Current (Amps)	Separation Partition ④		Fuse Casing ⑤		Terminal Cover ①		Separator ③	
		Part Ref	Carton Quantity	Part Ref	Carton Quantity	Part Ref	Carton Quantity	Part Ref	Carton Quantity
NH00*	160A	SP00*	2	FC00*	3	CS00*	6	BC00*	2
NH0	160A	SP0	2	FC0	3	CS0	6	BC0	2
NH1	250A	SP1-2	2	FC1-2	3	CS1	6	BC1-2	2
NH2	400A	SP1-2	2	FC1-2	3	CS2	6	BC1-2	2
NH3	630A	SP3	2	FC3	3	CS3	6	BC3	2

* For single pole only

IP Protection Kits

Part Reference	Description
TB00-D-IP20	Complete triple pole fuse base IP20 rated
FPK0-3P	IP20 kit for TB0-D fuse base
FPK1-3P	IP20 kit for TB1-D fuse base
FPK2-3P	IP20 kit for TB2-D fuse base
FPK3-3P	IP20 kit for TB3-D fuse base

Microswitch

Part Ref	Carton Quantity
BVL-50	1



Microswitch suitable for the following NH Fuse links:
 - 400 Volts gG/gL
 - 500 Volts gG/gL and aM
 - 690 Volts gG/gL and aM

Class gG/gL IEC 60269 Industrial Ferrule Fuses

8 x 31mm: 400Vac, 0.5 - 25A

Catalog Number	Rated Amps	Rated Voltage	Dimensions (mm)		
			A	B	C
C08G0-5	0.5	400Vac	8.5	31.5	6.3
C08G1	1				
C08G2	2				
C08G4	4				
C08G6	6				
C08G8	8				
C08G10	10				
C08G12	12				
C08G16	16				
C08G20	20				
C08G25	25				

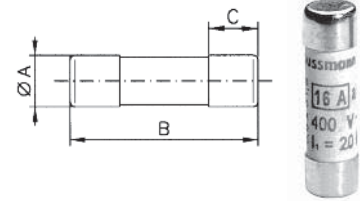

10 x 38mm: 500Vac, 0.5 - 32A

Catalog Number	Rated Amps	Rated Voltage	Dimensions (mm)		
			A	B	C
C10G0-5	0.5	500Vac	10.3	38	10
C10G1	1				
C10G2	2				
C10G4	4				
C10G6	6				
C10G8	8				
C10G10	10				
C10G12	12				
C10G16	16				
C10G20	20				
C10G25	25				
C10G32	32				

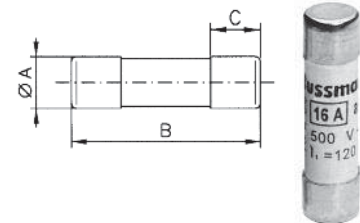

14 x 51mm: 400Vac - 500Vac - 690Vac, 1 - 50A

Catalog Number	Rated Amps	Rated Voltage	Dimensions (mm)									
			A	B	C	D	E					
C14G1	1	690Vac	14.3	51	13	8	4					
C14G2	2											
C14G4	4											
C14G6	6											
C14G8	8											
C14G10	10											
C14G12	12											
C14G16	16											
C14G20	20											
C14G25	25											
C14G32	32							500Vac				
C14G40	40							400Vac				
C14G50	50											

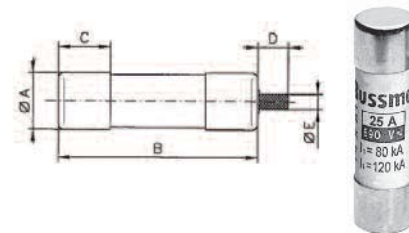

22 x 58mm: 400Vac - 500Vac - 690Vac, 2 - 125A

Catalog Number	Rated Amps	Rated Voltage	Dimensions (mm)				
			A	B	C	D	E
C22G2	2	690Vac	22.2	58	16	8	4
C22G4	4						
C22G6	6						
C22G8	8						
C22G10	10						
C22G12	12						
C22G16	16						
C22G20	20						
C22G25	25						
C22G32	32						
C22G40	40						
C22G50	50						
C22G63	63	400Vac					
C22G80	80						
C22G100	100						
C22G125	125						

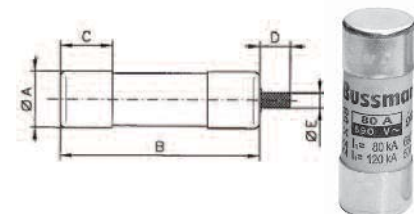

Class aM IEC Industrial Ferrule Fuses - Class aM IEC 60269

8 x 31mm: 400Vac, 1 - 8A

Catalog Number	Rated Amps	Rated Voltage	Dimensions (mm)		
			A	B	C
C08M1	1	400Vac	8.5	31.5	6.3
C08M2	2				
C08M4	4				
C08M6	6				
C08M8	8				

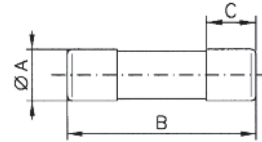

10 x 38mm: 400Vac - 550Vac, 0.16 - 25A

Catalog Number	Rated Amps	Rated Voltage	Dimensions (mm)		
			A	B	C
C10M0-16	0.16	550Vac	10.3	38.0	10.0
C10M0-25	0.25				
C10M0-5	0.5				
C10M1	1				
C10M2	2				
C10M4	4				
C10M6	6				
C10M8	8				
C10M10	10				
C10M12	12				
C10M16	16	400Vac	10.3	38.0	10.0
C10M20	20				
C10M25	25				

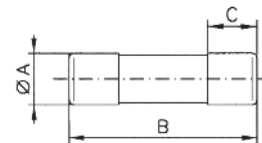

14 x 51mm: 690Vac - 500Vac, 0.25 - 50A

Catalog Number	Rated Amps	Rated Voltage	Dimensions (mm)		
			A	B	C
C14M0-25	0.25	690Vac	14.3	51	13
C14M1	1				
C14M2	2				
C14M4	4				
C14M6	6				
C14M8	8				
C14M10	10				
C14M12	12				
C14M16	16				
C14M20	20				
C14M25	25				
C14M32	32				
C14M40	40				
C14M50	50				

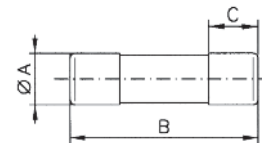

22 x 58mm: 400Vac - 500Vac - 690Vac, 2 - 125A

Catalog Number	Rated Amps	Rated Voltage	Dimensions (mm)		
			A	B	C
C22M2	2	690Vac	22.2	58	16
C22M4	4				
C22M6	6				
C22M8	8				
C22M10	10				
C22M12	12				
C22M16	16				
C22M20	20				
C22M25	25				
C22M32	32				
C22M40	40				
C22M50	50				
C22M63	63				
C22M80	80				
C22M100	100	400Vac	22.2	58	16
C22M125	125				



Neutral Links

Catalog Number	Product Class
C8NL	QR
C10NL	
C14NL	
C22NL	

Class aM & gG/gL IEC Industrial Ferrule Fuses with Striker

14 X 51



22 X 58



Class gG/gL with Striker

Catalog Number With Striker	Amp Rating	Watts Loss (W)	Voltage (AC)	Interrupting Rating (kA)
C14G2S	2	0.24	500	120
C14G4S	4	0.45		
C14G6S	6	0.42		
C14G8S	8	0.70		
C14G10S	10	0.53		
C14G12S	12	0.88		
C14G16S	16	1.16		
C14G20S	20	1.23		
C14G25S	25	1.46		
C14G32S	32	2.04		
C14G40S	40	3.34		
C14G50S	50	3.04		
Catalog Number With Striker	Amp Rating	Watts Loss (W)	Voltage (AC)	Interrupting Rating (kA)
C22G4S	4	0.48	690	80
C22G6S	6	0.47		
C22G8S	8	0.73		
C22G10S	10	0.74		
C22G12S	12	0.83		
C22G16S	16	1.21		
C22G20S	20	1.29		
C22G25S	25	1.53		
C22G32S	32	2.13		
C22G40S	40	3.40		
C22G50S	50	3.48		
C22G63S	63	4.46		
C22G80S	80	5.86	500	120
C22G100S	100	6.61		
C22G125S	125	8.42	400	

14 X 51



22 X 58



Class aM with Striker

Catalog Number With Striker	Amp Rating	Watts Loss (W)	Voltage (AC)	Interrupting Rating (kA)
C14M1S	1	0.14	500	120
C14M2S	2	0.24		
C14M4S	4	0.45		
C14M6S	6	0.42		
C14M8S	8	0.70		
C14M10S	10	0.53		
C14M12S	12	0.88		
C14M16S	16	1.16		
C14M20S	20	1.23		
C14M25S	25	1.46		
C14M32S	32	2.04		
C14M40S	40	3.34		
C14M50S	50	3.04	400	
Catalog Number With Striker	Amp Rating	Watts Loss (W)	Voltage (AC)	Interrupting Rating (kA)
C22M2S	2	0.29	690	80
C22M4S	4	0.48		
C22M6S	6	0.47		
C22M8S	8	0.73		
C22M10S	10	0.74		
C22M12S	12	0.83		
C22M16S	16	1.21		
C22M20S	20	1.29		
C22M25S	25	1.53		
C22M32S	32	2.13		
C22M40S	40	3.40		
C22M50S	50	3.48		
C22M63S	63	4.46		
C22M80S	80	5.86	500	120
C22M100S	100	6.61		
C22M125S	125	8.42	400	

HRC Fuse Holders

CAMaster

Specifications Catalog Symbol:

See table below.

Description: The CAMaster HRC fuse holder features a unique cam-action for easy fuse removal while allowing significantly improved contact pressure between fuse carrier and base contact that enhances electrical performance. A range of lockable safety carriers for the fuse holder (catalog reference: LSC), are available.

Ratings:

Volts: — 690V

Amps: — 30-100A (See Catalog Number table for details)

Agency Information: CE, CSA C22.2 No. 39; IEC 269 AND BS 88.

Mounting: 35mm DIN-Rail or single screw mounting.

Catalog Numbers

Catalog Numbers	Amp Ratings	Details For:	Fuse Accepted
CM20CF	30	HRCI-CA Applications	_CIF21
CM30CF	30	HRCII Applications	_H07C
CM60CF	60		_K07C
CM100CF	100		_K07CR

Accessory Catalog Numbers for CAMaster Units

Catalog Numbers	Amp Ratings	Details	Fuse Holder Accepted
20BS	30	Back Stud	CM20CF
32BS	30		CM30CF
60/100BS	60/100		CM60/100CF
GLP	All	Ganging Link Kit	3-Pole
NI	All	660V Neon Indicator	—
20LSC	30	Security Carrier with Clip	CM20CF
30LSC	30		CM30CF
60/100LSC	60/100A		CM60/100CF



SAFEloc

Specifications Catalog Symbol:

See table below.

Description: The SAFEloc HRC fuse holders (for use with HRCI-CB fuses) provides a positive, stress-free fuse fitting and locks it in position to ensure safe insertion and withdrawal from the base. Base contacts are fully shrouded to help protect against electric shock. Shrouds utilize simple slide/snap action allowing access to the contact terminal screws.

Ratings:

Volts: — 600V

Amps: — 30-60A (See Catalog Number table for details)

Agency Information: CE, Designed to accommodate the compact range of offset blade fuse to CSA C22.2 No. 106, HRCI-CB.

Mounting: 35mm DIN-Rail or single screw mounting.



Catalog Numbers*

Catalog Numbers	Amp Ratings	Connection	Fuse Accepted
C30F	30	Front	_CIF06
C30BS		Back	
C30FBS		Front-Back	
C60F	60	Front	EK-Amp
C60BS		Back	
C60FBS		Front-Back	

*For use with HRCI-CB Fuses.

Quik-Spec coordination panelboards



The new Quik-Spec coordination panelboard with a footprint up to 40% smaller than other fusible panelboards is now available up to 1200A

Bussmann
by **EAT•N**

Quik-Spec™ Electrical Gear

Section Contents

	Page
Quik-Spec Coordination Panel Boards	266-267
Quik-Spec Power Module Switches and Panels . .	268-269
Quik-Spec DC Safety Switches	270
Quik-Spec AC Safety Switches	271
A/C Disconnects - Fused and Non-Fused	272

RED indicates **NEW** information



Scan this tag to get the latest product information for Quik-Spec Coordination Panel Boards.



30-400A Quik-Spec™ Coordination Panelboard

Specifications

Description: Configurable fusible panelboard with 30-400A mains and branches from 1-100A rated 600Vac.

Ratings:

Volts: — 600Vac (or less), 125Vdc (or less)**

Bus Amps: — 30, 60, 100, 200, 225 or 400A

Options:

- Main: — MLO (main lug only)
- Fused disconnect switch
- Non-fused disconnect switch

Enclosure: — NEMA 1 or 3R

- Standard size panelboard (20" W x 5" D x various heights)*
- For other ratings consult factory

Panel: — Feed; Top & Bottom***

- Mounting; Surface or Flush****
- Door/Trim; Regular or Door-in-Door****

Branch: — Circuits; Up to 18, 30 and 42*

- Amps; Up to 100A
- Type; 1-, 2- and 3-Pole

Fuse: — Six-fuse spare fuse compartment

- Time-delay or UPS/critical applications (fast-acting) CUBEFuse™

Assembly

SCCR: — 200kA, 100kA or 50kA AC, 100kA or 20kA@125Vdc*

Through-Lugs

& Loadside

Disconnect: — Feed-Through - single and double
— Fused loadside disconnect, $\geq 100A \leq 200A$ (400A panels only)

Neutrals: — 200A and 400A Unbonded and Bonded

Ground: — Non-Isolated or Isolated

*Depending on configuration

**125Vdc rating applicable to 40 amp or less CCPBs on MLO panels only.

***Top feed not available on NEMA 3R enclosure

****Flush mount and Door-in-Door not available with NEMA 3R enclosure



QuikShip 
Made To Order

Agency Information: UL Listed to UL 67, complies with NFPA 70 (NEC®; National Electric Code),

Features and Benefits:

- UL and CSA listing makes it easy to address NEC® selective coordination requirements in an all fused system
- Value-engineered for greater flexibility with up to 400A mains, 200kA SCCR, 100A branches with 18, 30 and 42 branch positions
- Same size footprint as traditional circuit breaker panelboards and 40% smaller than standard fusible panelboards: 20" W x 5 3/4" D x various heights (depending on configuration)
- Increase safety with current-limiting finger-safe Low-Peak CUBEFuse that reduces arc flash hazard levels
- Quik-Quote online configurator makes specifying and ordering easy – delivers a full bill of material and submittal drawings for an entire project
- Available for 10 day shipment with QuikShip™ service

Ordering:

The QSCP is factory configured to the specific electrical system. Contact your Bussmann distributor or representative to place your order. Have all relevant electrical and circuit information on hand.

QuikShip – 10 Business Day Shipment

600-1200A Quik-Spec™ Coordination Panelboard

Specifications

Description: Fusible panelboard with 600, 800 and 1200A mains and branches from 1-600A, rated 600Vac.

Ratings:

Volts: — 600Vac (or less), 125Vdc
Amps: — 600, 800 and 1200A

Options:

- Main: — Main lug only
- Enclosure: — NEMA 1 floor mount
- Branch: — 1-, 2- and 3-pole, 15-600A branch disconnect
- Fuse: — Time-delay, non-indicating (Class CF TCF_R and/or Class J LPJ_SP)
- Time-delay, indicating (Class CF TCF_ and/or Class J LPJ_SPI)
- Fast-acting, non-indicating (Class CF TCF_RN and/or Class J JKS)
- DFJ high speed Class J fuses

Agency Information: Complies with NFPA 70 (NEC®, National Electrical Code®) UL Listed to UL 67,

Features and Benefits:

- Configurable panelboards with options for 600, 800 and 1200A mains and branches from 1-600A all rated 200kA SCCR at 600Vac
- Smallest standard fusible panelboards in the industry
- Featuring the finger-safe UL Class CF CUBEFuse with 1-600A ampacity rejection features (1-100A)
- Available with time-delay or UPS/Critical application fast-acting fuses



- UL listing makes it simple to address NEC® selective coordination system requirements in an all fused system
- Quik-Quote online configurator makes specifying and ordering easy – delivers a full bill of material and submittal drawings for an entire project

Ordering:

The QSCP is factory configured to the specific electrical system. Contact your Bussmann distributor or representative to place your order. Have all relevant electrical and circuit information on hand.

QuikShip – 10 Business Day Shipment

Configuration and Dimension Chart

Panel Ampacity	Branch Configurations	Dimension (inches)		
		H	W	D
600A	(18) 1-100A	65	27	15
	(18) 1-100A + 200A single			
	(18) 1-100A + 200A twin			
	200A single + 200A single			
	200A single + 200A twin			
	200A twin + 200A twin			
800A	(2) 300A single	89	38	15
	(18) 1-100A + 200A single			
	(18) 1-100A + 200A twin			
	(2) 200A twin	89	38	15
	(18) 1-100A + 400A single			
	200A twin + 400A single			
1200A	(2) 400A single	89	38	15
	(18) 1-100A + 600A single			
	(3) 200A twin			
	200A twin + 600A single	102	38	15
	(2) 200A twin + 400A single			
	(3) 400A single			
	600A single + 400A single + 200A single			
600A single + 400A single + 200A twin				
(2) 600A single				

Data Sheet: 1171

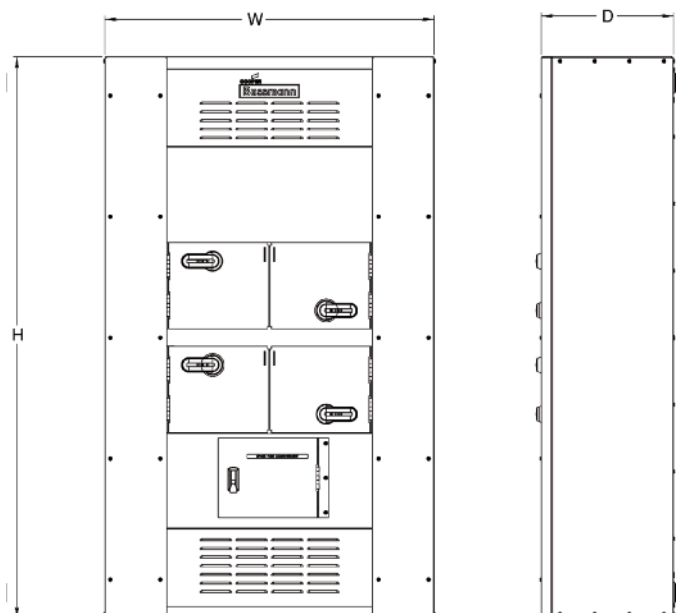

Quik-Spec™
Electrical
Gear

Quik-Spec™ Power Module — All-in-one Elevator Disconnect

PS & PMP

Bussmann Quik-Spec Power Module

Specifications

Description: Fusible power switch or panel with shunt trip and fire safety interface to allow for single point tie in with fire alarm system.

Ratings:

- Volts: — 600Vac, 3Ø
- Amps: — 30-400A (PS)
 - 30-200A (PMP feeder switches)
 - 400-800A (PMP main switches*)

Assembly

SCCR: — 200kA RMS

*Contact Bussmann for applications greater than 800A.

Agency Information: Complies with NFPA 70 (NEC®; National Electrical Code®),

- Elevator Shutdown — ANSI/ASME A17.1, 2.8.3.3.2
 - NEC® 620.51(B) (Elevator Shutdown)
 - NEC® 240.12 (Orderly Shutdown)
- Shunt Trip Voltage Monitoring — NFPA 72, 6.16.4.4
- Selective Coordination — NEC® 620.62
- Auxiliary Contact (Hydraulic Elevator) — NEC® 620.91(C)
- Power Module Switch (PS); UL Listed (UL 98) Enclosed and Dead front switch Guide 96NK3917, File E182262, NEMA 1, UL 50 Listed enclosure**, cUL per Canadian Standards C22.2, No. 0-M91-CAN/CSA C22.2, No. 4-M89 Enclosed switch.

**NEMA 12, 3R, and 4 enclosures also available

- Power Module Panel (PMP); UL 98 Enclosed and Deadfront Switches.

Features and Benefits:

- Internally powered, relay activated shunt trip system
- Mechanically interlocked auxiliary contact
- Self-contained adherence to elevator consensus standards, NFPA 70 (NEC®). NFPA 72, ANSI/ASME 17.1
- Shunt trip capability
- Selective coordination
- Fire safety signal interface
- Shunt trip voltage monitoring
- Component protection via Bussmann Low-Peak™ Class J fuses
- UL 98 Listed for 200kA short-circuit current rating
- Lockable in the open position with three-lock capability
- Optional key-test switch and optional pilot light for easy inspection
- No annual calibration or testing of overcurrent protection required
- Padlockable for service-work safety and open-door “override” for troubleshooting

Typical Applications:

- Elevator Disconnects
- Computer Room Shunt Trip Disconnect
- Fire Safety Interface Relay

Accessories:

- For added safety, use the Bussmann SAMI™ fuse covers to improve maintenance personnel protection (OSHA 1910.333, paragraph C)

Ordering:

The Bussmann Quik-Spec™ Power Module Switch and Panel are factory configured to the specific application. Contact your Bussmann representative to place your order. Have all relevant electrical and circuit information on hand.

PS*

The Quik-Spec™ Power Module Switch (PS) for single elevator applications.



PMP*

Power Module™ Panel (PMP) for multiple elevator applications.



Scan this tag to get the latest videos for the Power Module.

*Fused main disconnect requires Class J fuses, not supplied with switch.

Quik-Spec™ Power Module — All-in-one Elevator Disconnect

Hydraulic Elevators

Hydraulic elevators need battery backup to help prevent stranding passengers. To keep the elevator from moving when it's been manually shut down for maintenance, the NEC® requires battery backup be connected to the elevator disconnecting means through an auxillary contact.

However, an unintended consequence can be passengers getting stranded because of devices that open automatically (circuit breakers and disconnects utilizing a

molded case switch with a trailing fuse block) will operate with a fault on their loadside. That operation also disables the battery backup and strands passengers. That's why the Power Module has a non-automatic fusible shunt trip switch. If the Power Module has a fault on its loadside, the fuses open and the battery stays enabled. Thus the Power Module ensures that battery power is enabled when the passengers need it to exit - and disabled to allow safe maintenance of the elevator and hoistway.

Scenario	Battery Lowering Required	Reason	Offered By Power Module™	Offered By Other Elevator Disconnects
Power failure	Yes	Need to lower elevator to allow passengers to exit.	Yes	Yes
Fire in shaft or machine room	No	Recall is initiated by smoke detector and lowers elevator to a safe floor. Battery not needed.	Yes	Yes
Disconnect manually opened	No	Worker to perform maintenance. Elevator must remain stationary to prevent injury.	Yes	Yes
Fault on loadside of disconnect	Yes	Need to lower elevator to allow passengers to exit.	Yes	No

Quik-Spec™ Power Module Switch Catalog Numbering System

Power Module Switch Catalog Number System

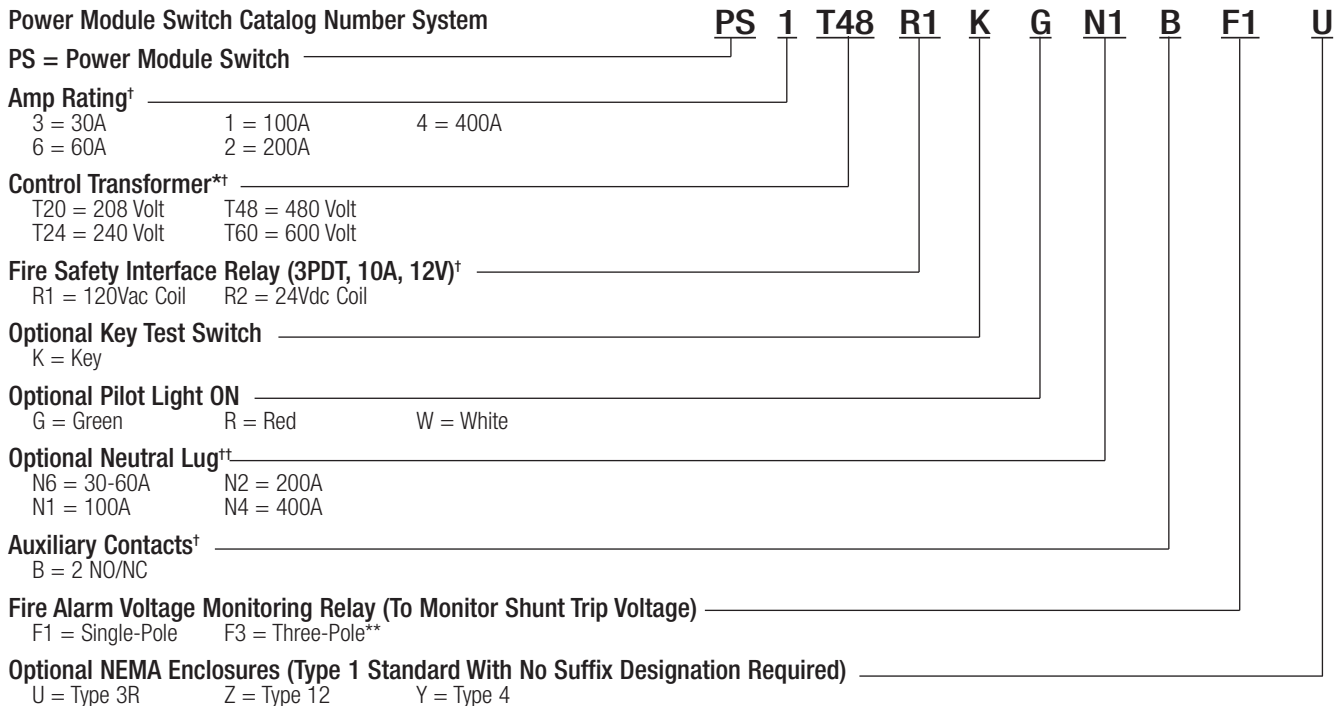

* 100Va with Primary and Secondary fusing (120V Secondary)

** Only for use with R1 option

† Required equipment.

†† Neutral lug rating should be equal to or greater than the switch amp rating.

Quik-Ship Program: Switch - 3 Days, Panel - 10 Days!

Ship-direct service within three business days for Power Module Switches (PS_) and 10 business days for Power Module Panels (PMP_).

* Three day PS_ shipment requires ordering from catalog numbers shown.

** 10 Day PMP_ shipment covers NEMA 1 enclosures with the ampacities shown and all requirements for relay type (AC or DC), accessory options and number of switches. To order PMP_, contact your Bussmann representative with all relevant electrical and circuit information, we do the rest.

Power Module Switch*			Power Module Panel**	
Cat Numbers	Amps	Volts	Cat. Numbers	Amps
PS6T48R1KGBF3-X	60A	480V	PMP-400-X	400A
PS1T48R1KGBF3-X	100A	480V	PMP-600-X	600A
PS1T20R1KGBF3-X	100A	208V	PMP-800-X	800A
PS2T48R1KGBF3-X	200A	480V		
PS2T20R1KGBF3-X	200A	208V		

Quik-Spec™ DC Safety Switch

Isolating DC Circuits Has Never Been Easier or Safer

- Flexibility of Application
- Enhanced Finger-Safe Design
- Meets UL and NEC® Requirements
- Flange Handle Operation
- Current-Limiting Fuses Reduce Arc Flash Hazard

NEC 690.17 Compliant Label

Warns that the switch terminals may be energized in the open position



High Visibility Padlockable Handle

Easy to operate with gloves and up to three padlocks to protect maintenance personnel

Visible Switch Contacts

Positive visual identification of switch state

Door Interlock

Prevents opening door while energized, but can be manually overridden for testing or inspection.

Clear Polycarbonate Deadfront

Covers energized parts to provide added protection against electrical hazards. Lineside stays in place during fuse servicing.

Fused Version For Added Protection

Fuse clips located on switch center pole to ensure both clips are de-energized in OFF position. Meets NEC® Article 690.16 that requires isolating the fuse from all potential supply sources. Cooper Bussmann recommends using the Limitron fast-acting, current limiting PVS-R Class RK5 fuse (order separately.)

Conduit Knockouts

For easy conductor installation

NEMA 3R, 12 & 4X Enclosures

Meet many application requirements. 3R and 4X stainless steel well suited for isolating outdoor solar power installations

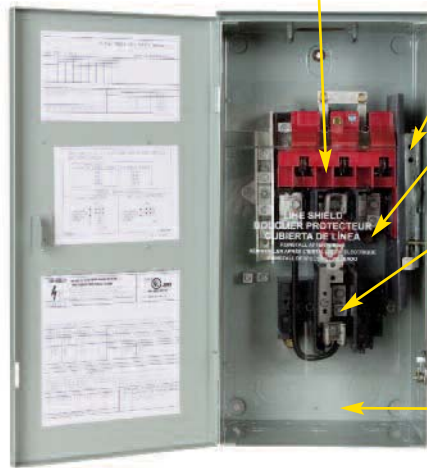

Type 3R Dimensions

Amps	A	B	C	Main Lug Capacity	Neutral Lug Capacity	I _{sc}
30	16.35	8.87	9.89	#2 AWG - #14 AWG Al/Cu	#4 AWG - #14 AWG Al/Cu	19.2
60	16.35	8.87	9.89	#2 AWG - #14 AWG Al/Cu	#4 AWG - #14 AWG Al/Cu	38.4
100	22.15	11.84	9.89	1/0 AWG - #14 AWG Al/Cu	#4 AWG - #14 AWG Al/Cu	64.0
200	28.27	16.66	11.26	250kcmil - #6 AWG Al/Cu	#2 AWG - #14 AWG Al/Cu	128.0

Type 12 & 4X Dimensions

Amps	A	B	C	Main Lug Capacity	Neutral Lug Capacity	I _{sc}
30 & 60 Non-fusible	14.14	8.76	10.22	#2 AWG - #14 AWG Al/Cu	#4 AWG - #14 AWG Al/Cu	19.2
30 & 60 Fusible	19.08	8.76	10.22	#2 AWG - #14 AWG Al/Cu	#4 AWG - #14 AWG Al/Cu	19.2
100	24.95	11.79	10.22	1/0 AWG - #14 AWG Al/Cu	#4 AWG - #14 AWG Al/Cu	64.0
200	35.38	16.95	11.63	250kcmil - #6 AWG Al/Cu	#2 AWG - #14 AWG Al/Cu	128.0

Dimensions - in

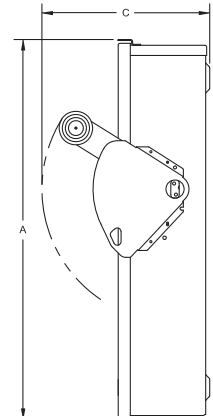
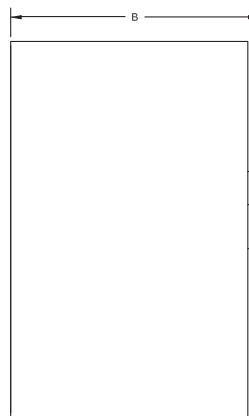
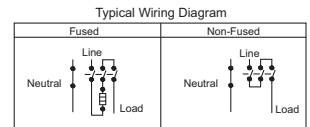
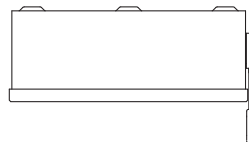

DC Safety Switch Catalog Numbering System

Use this build-a-code to specify the exact Quik-Spec DC Safety Switch you need.

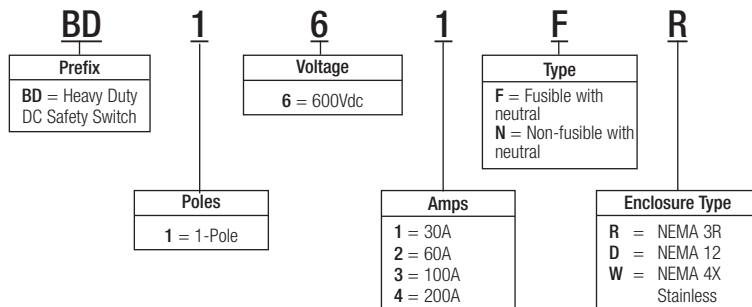

Quik-Spec™ Safety Switch

Bussmann Quik-Spec™ Safety Switch



Specifications

Description: The Bussmann Quik-Spec™ Safety Switch equipped with finger-safe Low-Peak CUBEFuse provides superior safety and reliability for industrial customers.

Utilizing the Bussmann Class CF Low-Peak CUBEFuse, the Quik-Spec Safety Switch provides Class J fuse performance characteristics that can help mitigate incident energy and arc-flash hazard, and offers excellent component protection.

The Bussmann CUBEFuse requires no tools to install or replace.

Agency Information:

- UL 98 standard for enclosed deadfront switches.
- UL 50 standard for enclosures for electrical equipment.
- NEMA KS 1.
- UL Listed, File E5239.
- cUL Listed to C22.2 No.4-M89.

Standard Features:

- Extended line terminal shield and finger-safe 30, 60, or 100A Bussmann CUBEFuse
- 200kA short-circuit current rating
- Visible double break quick-make, quick-break rotary blade mechanism
- Triple padlocking capability
- Mechanically interlocked door
- 600Vac/250Vdc maximum

Optional Features:

- Viewing window for visible blades and open fuse indication
- NEMA 1, 3R, 12, 4X (stainless)
- Suitable for use as service equipment (with neutral kit)

Dimensions - inches (mm)*

NEMA 1 & 3R

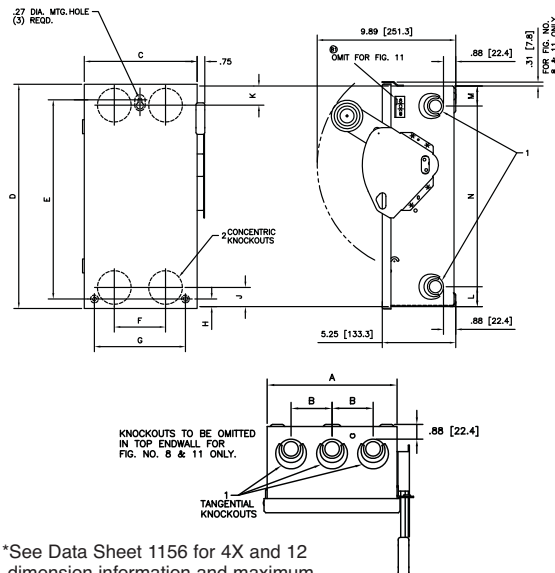

*See Data Sheet 1156 for 4X and 12 dimension information and maximum horsepower ratings.

Quik-Spec™ Safety Switch Catalog Numbering System

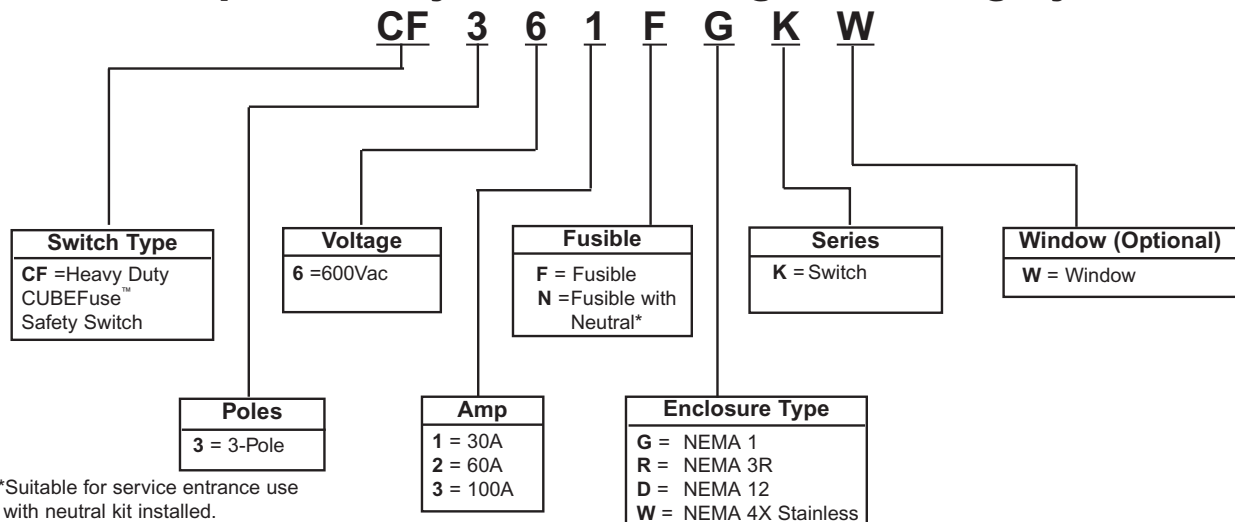

A/C Disconnects — Fused and Non-fused

Series B22__

Specifications

Description: Fused and non-fused rainproof pullout air conditioner units.

Dimensions: See Catalog Numbers table.

Construction: NEMA 3R metal housing with weather resistant coating.

Wire Range: 14-3 AWG, Al/Cu

Ratings:

Phase: — Single, 2-wire

Volts: — 240Vac

Amps: — 30-60A

Agency Information: UL Listed to UL 1429, cUL Certified, UL Guide WGEW

Features and Benefits

- A/C disconnects meet NEC® Code Requirements under articles 440.14. GFCI units meet NEC® Code Requirements under articles 210.63, 210.8, and 406.8(B)(1).
- NEMA 3R rainproof enclosures withstand outdoor environment.
- Padlockable with two-position pullout handle to lock safety shield when in the ON position. (Not available on GF or NA units.) For added safety, pullout handle can be stored in the compartment in the off position.

Typical Applications

- Residential, light industrial/commercial A/C and heat pump service.
- Spas/whirlpools, swimming pools, pump houses.
- Suitable for service entrance equipment applications with field installable ground bar, kit number DPF6.



Metallic Fused Disconnect

Metallic Non-Fused Disconnect

Metallic Non-Fused Disconnect with Weather Resistant-Tamper Resistant GFCI Receptacle.



Catalog Numbers

Fused

Catalog Numbers	Description	Disconnect Rating	Max Hp Rating		Wire Range 60 or 75°C Cu/Al	Enclosure Type	Fuse Class	Approx. Dimensions (in)		
			120V	240V				Height	Width	Depth
B221-30F	30A, Pullout	30A	1.5	3	#14-3	NEMA 3R	H or R	8 ¾	5 ¾	2 ½
B221-30FGF	30A, Pullout w/ GFCI	30A	1.5	3	#14-3	NEMA 3R	H or R	13	7 ½	4 ¾
B221-30FGFWRTR	30A, Pullout w/ WRTR-Rated GFCI	30A	1.5	3	#14-3	NEMA 3R	H or R	13	7 ½	4 ¾
B222-60F	60A, Pullout	60A	3	10	#14-3	NEMA 3R	H or R	8 ¾	5 ¾	2 ½
B222-60FGF	60A, Pullout w/ GFCI	60A	3	10	#14-3	NEMA 3R	H or R	13	7 ½	4 ¾
B222-60FGFWRTR	60A, Pullout w/ WRTR-Rated GFCI	60A	3	10	#14-3	NEMA 3R	H or R	13	7 ½	4 ¾
Non-Fused										
B222-60NF	60A, Pullout	60A	3	10	#14-3	NEMA 3R	*	8 ¾	5 ¾	2 ½
B222-60NFGF	60A, Pullout w/ GFCI	60A	3	10	#14-3	NEMA 3R	*	11 ¾	6 ½	4 ½
B222-60NFGFWRTR	60A, Pullout w/ WRTR-Rated GFCI	60A	3	10	#14-3	NEMA 3R	*	11 ¾	6 ½	4 ½
B222-60NFNA	60A, Switch	60A	*	10	#14-3	NEMA 3R	*	8 ¾	5 ¾	3 ¾

30 and 60A pullout replacement handle: 96-3258-4.

*Upstream overcurrent protective device (OPCD) not to exceed 60A.

Fuse Holders and Blocks

Section Contents Page

CH Series Global Modular fuse holders and accessories 274-280

Remote Fuse Monitoring - CH-PLCCH 278

Comb-Bus bar specifications and selection guide 279

Comb-Bus bar features and installation guide 280

CH Series Class J modular fuse holders 281

OPM-1038 3-pole fuse holders with disconnect switch 282

OPM-1038 3-pole fuse holders 283

OPMNGA- 3-pole Class CC and 1 $\frac{3}{8}$ " X 1 $\frac{1}{2}$ " fuse overcurrent protection modules 284-285

JT(N)60030 & JT(N)600600 Safety J™ Class J fuse holders 286-287

SAMI™ fuse covers 288

Modular Knifeblade Fuse Holders 289-290

Class R, H(K), 250 & 600V 291-292

Class J, 600V 293

H250 & R250 Series 250V Class H (K) and R fuse blocks 294-295

H600 & R600 600V Class H (K) and R fuse blocks 296-297

J600 Series Class J fuse blocks 298

JP Series Class J fuse blocks 299

T300 300V Class T fuse blocks 300-301

T600 600V Class T fuse blocks 302-303

BCA Series Class CC add-a-pole modular fuse blocks 304

BMA Series 1 $\frac{3}{8}$ " X 1 $\frac{1}{2}$ " fuse add-a-pole modular fuse blocks 304

BC Series Class CC fuse blocks 305

BM Series Type M 1 $\frac{3}{8}$ " X 1 $\frac{1}{2}$ " fuse blocks 305

BG & G Series Class G fuse blocks 305

BH Series high speed fuse modular fuse blocks 306

Class H & J modular fuse blocks 306

Plug fuse box cover units 307

HFB & HEB-10 in-line fuse holders for 1/4" X 1 1/4" fuses 308

HHB & HRK universal in-line fuse holders for 1/4" dia. fuses 308

HR & HM Series in-line fuse holders for 1/4" dia. fuses 309

HFA Series waterproof in-line fuse holders for 1/4" X 1 1/4" fuses 309

HHT Series in-line fuse holders for 5 X 15 to 20mm fuses 309

Tron™ in-line fuse holders (New HEZ) 309-311

Panel mounted fuse holders for 5 X 20mm fuses 312

Panel mounted fuse holders for 1/4" X 1 1/4" fuses 313

Panel mounted fuse holders for 5 X 20mm and 1/4" X 1 1/4" fuses 314-315

Panel mounted fuse holders for indicating type fuses 316

Panel mounted fuse holders for 1 $\frac{3}{8}$ " X 1 $\frac{5}{16}$ " to 1 $\frac{1}{2}$ " fuses 317

Panel mounted fuse holders for 1 $\frac{3}{8}$ " X 1 $\frac{1}{2}$ " fuses 318

Fuse blocks for 1/4" X 1 1/4" fuses 319

Fuse blocks for 1/4" X 1" fuses 320

Fuse blocks for 1 $\frac{3}{8}$ " X 1 $\frac{1}{2}$ " fuses 321

Rail mount fuse holders 322

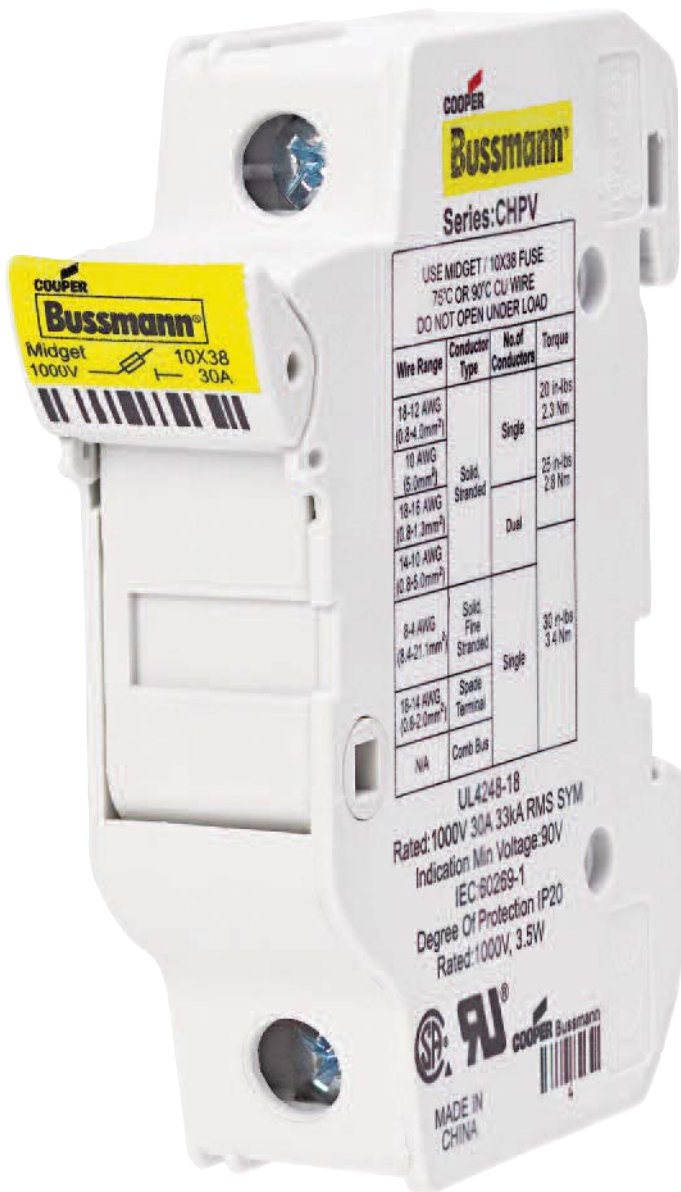

RED indicates NEW information

Fuse Holders & Blocks

Global Modular Fuse Holders

CH Series - 8x32, 10x38, 14x51, 22x58, Class CC

Specifications

Description: The 'CH' line of modular fuse holders accommodates many fuses from around the world, including North American Class-CC, Midget, Class gR, aR HSF, and IEC Industrial Ferrule (Class gG and aM) in four physical sizes: 8x32, 10x38, 14x51 and 22x58mm.



Agency Information:

UL File E14853
Guide IZLT Listed, IZLT2 Recognized
CSA: File 47235, CHPV and CHM - Class 6225-30,
CHCC - Class 6225-01

Ratings:

600V/30A (UL)
690V/32A (IEC)

Wire Range:

#18 to #4 (0.8mm² to 21.1mm²)

Torque Ratings:

30 Lb-In (3.4 N•m) maximum

Flammability Ratings:

UL 94V0, self-extinguishing

Storage & Operating Temperature Range:

-20°C to +90°C (indicating)
-20°C to +120°C (non-indicating)

Features/Benefits

- High SCCR rated, UL Listed Class CC holder with indicator option for 600Vac/dc and 48Vdc.
- UL Recognized midget and 10 x 38 holders with factory assembled neutral pole option.
- Agency ratings up to 1000Vdc for use with solar PV fuses.
- Available remote PLC indication with the CH-PLC module.
- Terminals rated for use with 75°C or 90°C wire, fine stranded wire, spade terminals and comb-bus bars. Use any higher temperature rated wire with appropriate derating.
- Complete range of UL Listed and high SCCR rated 1-phase and 3-phase finger-safe comb-bus bars and power feed lugs.

Series & Size	Catalog Number		Voltage & Current	Agency Markings	Number of Poles	Terminal Rating	SCCR Rating	Cooper Bussmann Fuses
	With Indicator	Without Indicator						
CHM 10x38 and Midget	CHM1DIU	CHM1DU	UL 600V/30A; IEC 690V/32A	cURus; IEC 60269-2	1	Solid, Stranded, Fine Stranded, Spade Lug, Comb Bus Bar; Single and Dual Wire; 75°C and 90°C Cu wire	100kA rms sym	FNQ, KLM, FNM, KTK, BAF, FWA, DCM, C10 SERIES, AGU, BAN, FWC
	CHM2DIU	CHM2DU			2			
	CHM3DIU	CHM3DU			3			
	CHM4DIU	CHM4DU			4			
	CHM1DNIU	CHM1DNU	60269-2	1 pole + 1 neutral				
	CHM3DNIU	CHM3DNU		3 poles + 1 neutral				
	CHM1DI-48U		UL 48Vdc/30A; IEC 48Vdc/32A		1			
	CHM1DNXU	IEC 690V/32A	IEC60269-2	1 neutral	n/a	n/a		
CHPV	CHPV1IU	CHPV1U	UL & IEC; 1000Vdc/30A	UR, CSA, UL4248-18, IEC60269-1	1	33kA rms sym	Solar PV series	
	CHPV2IU	CHPV2U			2			
CHCC Class CC	CHCC1DIU	CHCC1DU	UL 600V/30A	cULus	1	200kA rms sym	LP-CC, FNQ-R, KTK-R	
	CHCC2DIU	CHCC2DU			2			
	CHCC3DIU	CHCC3DU			3			
		CHCC1DI-48U	UL 48Vdc/30A		1			

Rail Mount Fuse Blocks and Holders

CHM & CHMI

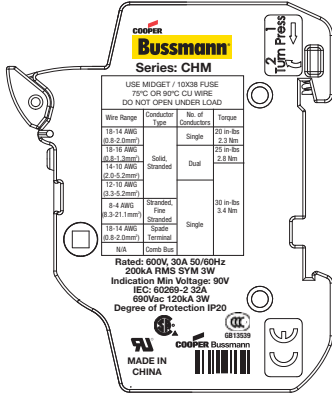

CHCC & CHCCI

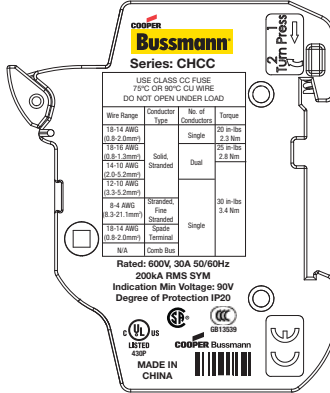

CHPV & CHPVI

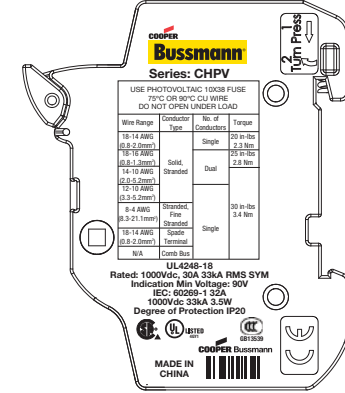

Features

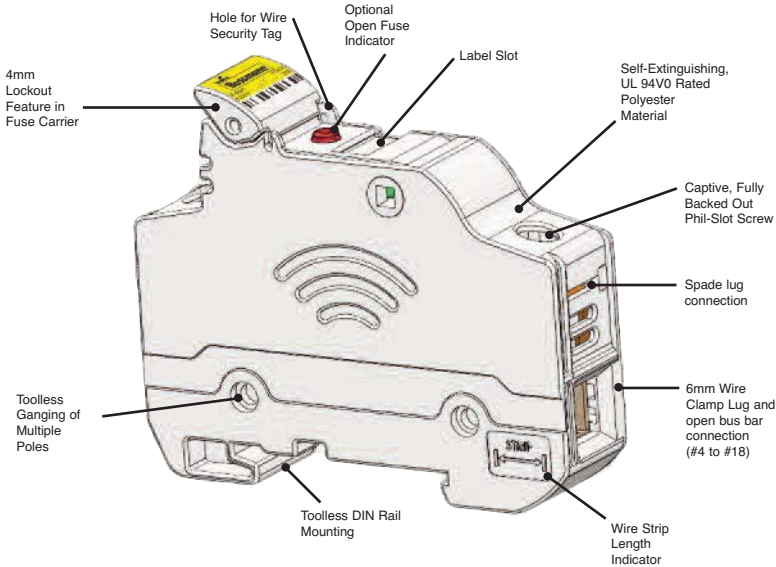

Multi-Pole Ganging

Use multi-pole connection kit part number JV-L to gang multiple poles together. One JV-L kit is sufficient to gang up to 4 poles.

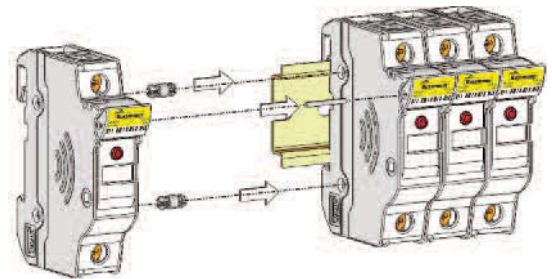

For additional information see reorder #3185

Rail Mount Fuse Blocks and Holders

Dimensional Data - mm (in)

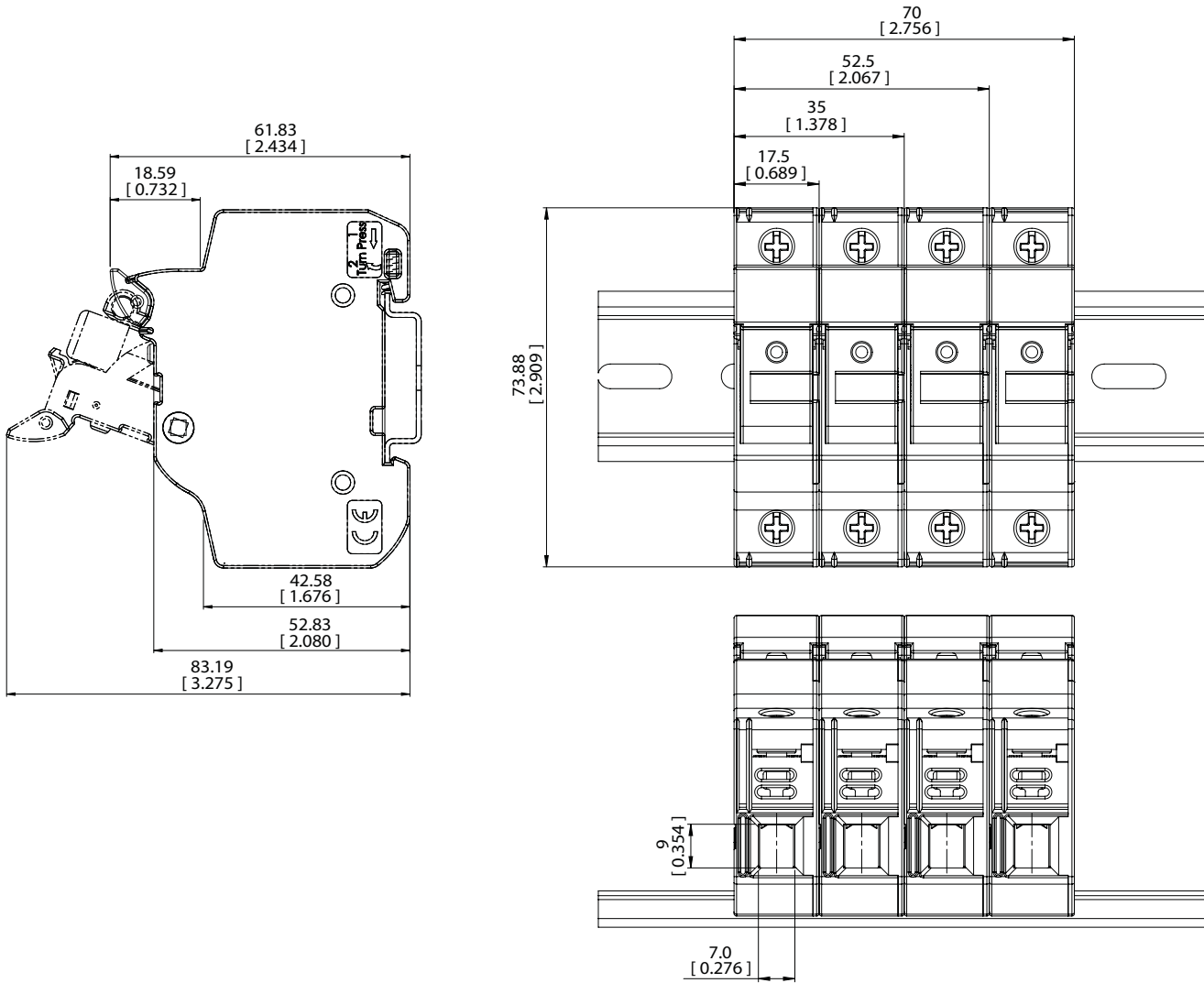

Removing Instructions

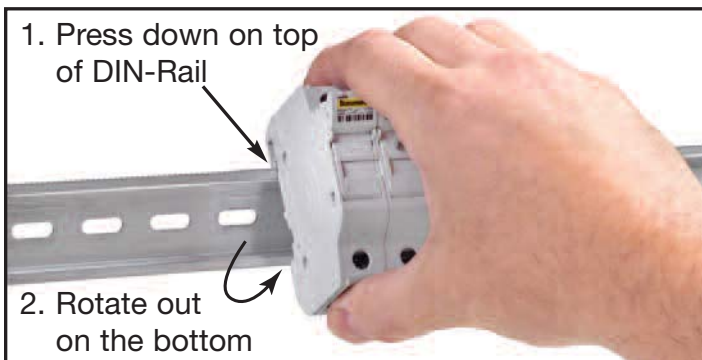

Global Modular Fuse Holders



Catalog Numbers											
Without Indication	With* Indication	Size	Max Voltage & Current	IEC	UL	Phase Configuration	No. of 17.5mm Modules	Wire Range	Maximum Torque		
CH081D	CH081DI	CH08 8x32	IEC 400Vac 25A	•		1-pole	1	1-16mm ² (18-8 AWG)	2.5 N•m (22LB-In)		
CH081DNX	-			•		1 Neutral Pole	1				
CH081DNS	CH081DNSI			•		1-pole + Neutral	1	1-10mm ² (18-8 AWG)	2.0 N•m (17.5LB-In)		
CH081DN	CH081DNI			•		1-pole + Neutral	2	1-16mm ² (18-8 AWG)	2.5 N•m (22LB-In)		
CH082D	CH082DI			•		2-pole	2				
CH083D	CH083DI			•		3-pole	3				
CH083DNS	CH083DNSI			•		3-pole + Neutral	3				
CH083DN	CH083DNI			•		3-pole + Neutral	4				
CH084D	CH084DI			•		4-pole	4				
CHM1DU	CHM1DIU			CHM 10X38 and Midget	UL 600V/30A; IEC 690V/32A	•	*	1-pole	1	1-21mm ² (18-4 AWG)	3.4 N•m (30LB-In)
CHM2DU	CHM2DIU	•	*			2-pole	2				
CHM3DU	CHM3DIU	•	*			3-pole	3				
CHM4DU	CHM4DIU	•	*			4-pole	4				
CHM1DNU	CHM1DNIU	•	*			1-pole + Neutral	2				
CHM3DNU	CHM3DNIU	•	*			3-pole + Neutral	4				
-	CHM1DI-48U	UL 48Vdc/30A; IEC 48Vdc/32A	•			*	1-pole	1			
CHM1DNXU	-	IEC 690V/32A	•				1-pole + Neutral	2			
CHPV1U	CHPV1IU	CHPV	UL & IEC; 1000Vdc/30A			•	†††	1-pole	1	1-21mm ² (18-4 AWG)	3.4 N•m (30LB-In)
CHPV2U	CHPV2IU					•	†††	2-pole	2		
CHCC1DU	CHCC1DIU	CHCC Class CC	UL 600V/30A		**	1-pole	1				
CHCC2DU	CHCC2DIU				**	2-pole	2				
CHCC3DU	CHCC3DIU				**	3-pole	3				
CHCC1DI-48U	-			UL 48Vdc/30A		**	1-pole	1			
CH141D	CH141DI	CH14 14x51	UL 600Vac/dc 40A (5 Watt) IEC 690Vac, 50A	•		1-pole	1.5	2.5-16mm ² (14-6 AWG)	3.0 N•m (26LB-In)		
CH141DMS	-			•		1-pole + Microswitch	1.5				
CH141DNX	-			•		1 Neutral Pole	1.5				
CH141DN	CH141DNI			•		1-pole + Neutral	3				
CH142D	CH142DI			•	†	2-pole	3				
CH143D	CH143DI			•	†	3-pole	4.5				
CH143DMS	-			•		3-pole + Microswitch	4.5				
CH143DN	CH143DNI			•		3-pole + Neutral	6				
CH143DNMS	-			•		3-pole + Neutral + Microswitch	6				
CH144D	CH144DI			•		4-pole	6				
CH221D	Not Available	CH22 22x58	UL 600Vac/dc, 100A (9.5 Watt) IEC 690Vac, 125A	•	†	1-pole	2	2.5-50mm ² (14-1 AWG)	4.0 N•m (35LB-In)		
CH221DMS	Available with local neon indication (remote microswitch only)			•		1-pole + Microswitch	2				
CH221DNX	-			•		1 Neutral Pole	2				
CH221DN	-			•		1-pole + Neutral	4				
CH222D	-			•	†	2-pole	4				
CH223D	-			•	†	3-pole	6				
CH223DMS	-			•		3-pole + Microswitch	6				
CH223DN	-			•	†	3-pole + Neutral	8				
CH223DNMS	-			•		3-pole + Neutral + Microswitch	8				
CH224D	-			•		4-pole	8				
Class J easyID™ Indication	Neon Indication										
CH30J1	CH30J1I	CH30J	UL/CSA 30A 600Vac		††	1-pole	—	1-50mm ² (18-1 AWG)	1-8 AWG 4.0 N•m (35LB-In)		
CH30J2	CH30J2I	30A			††	2-pole	—	10-18 AWG 2.7N•m (24LB-In)			
CH30J3	CH30J3I	Class J			††	3-pole	—				
CH60J1	CH60J1I	CH60J	UL/CSA 60A 600Vac		††	1-pole	—	1-50mm ² (18-1 AWG)	1-8 AWG 4.0 N•m (35LB-In)		
CH60J2	CH60J2I	60A			††	2-pole	—	10-18 AWG 2.7N•m (24LB-In)			
CH60J3	CH60J3I	Class J			††	3-pole	—				

† UL Recognized (cULus) †† UL Listed (cULus) ††† UL Recognized, Standard 4248-18, CSA
 For further details see Data Sheets 2053 (CH08, CHM, CHCC, CH14 AND CH22) and 2144 (CHJ Class J)
 *90V minimum required for illumination
 ***12V minimum required for illumination

For additional information see reorder #3185

Global Modular Fuse Holders - Remote Fuse Monitoring Accessory CH-PLC

Make it Simple with Bussmann resettable three-phase remote fuse monitor that integrates with a Programmable Logic Controller (PLC) or other monitoring and control equipment.

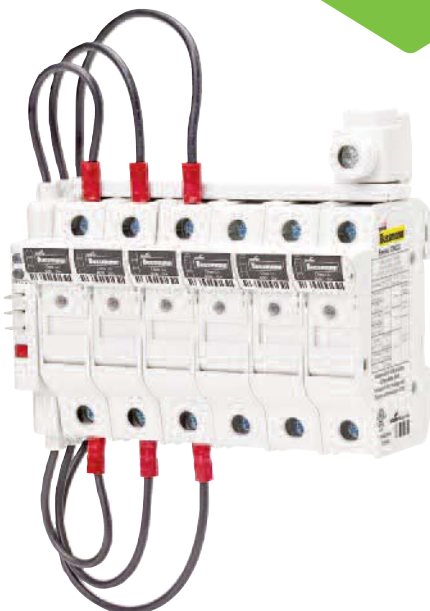
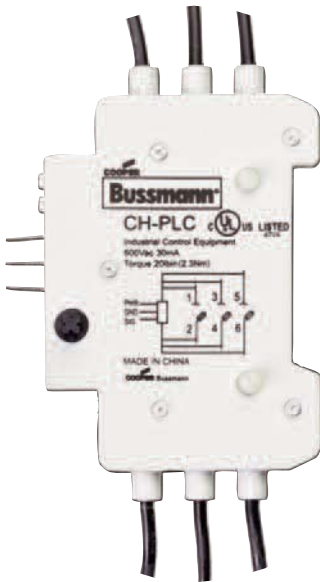

Specifications:

- **Power Input:** 24Vdc / 5mA
- **Sensing Voltage:** 600V/30mA
- **Output Signals:** Digital 0Vdc (Low), 24Vdc (High)
 - 0Vdc Low – Fuse is good
 - 24Vdc High – Fuse has opened

When the fuse opens, the output signal is sent high and will remain high until the unit is reset
- **Rated Impulse Voltage:** 8kV
- **Local Indication:** Two distinct LEDs indicate unit power (green) and open fuse (red). Upon the replacement of the fuse, the actuation of the reset switch will reset the open fuse LED
- **Flammability Rating:** UL 94V0

Wiring:

- For power, signal and ground connections use 22-24AWG (0.25mm²) 300V rated wire

Emissions and Immunity Testing:

- Electrostatic Discharge IEC 61000-4-2
- Electrical Fast Transient/Burst IEC 6100-4-4
- Surge Immunity IEC61000-4-5

Packaging:

- The CH-PLC is packaged individually
- A single unit monitors up to three phases
- Package includes 0.11" (2.8mm) quick connects for power, signal and ground connections

Minimum Circuit Voltage:

- Minimum circuit voltage required across the CH holder is 100Vac for the remote indication device to operate

Installation Technique:

- Mounts on the left side of the fuse holder and mechanically interlocks with the fuse holder switch handle with hardware provided

IP20 Rating: Yes

Environmental Data:

- Storage and Operating Temperature: -20°C to 75°C

Agency Information:

- UL 508
- cULus to CSA Standard 22.2 No.14

PLC Programming:

- The CH-PLC signal line is designed to provide a digital input to a PLC I/O card.
- Programmable Logic Control program must be written to properly interpret the input signal to the PLC.
- The PLC program should check for consecutive high signals before taking action on a critical process.

De-energize all circuits before installing or removing any CH-PLC devices and follow all prescribed safety procedures.

For additional information see reorder #3185

Global Modular Fuse Holders - Comb-Bus Bar Specifications and Selection Guide

Specifications

- Agency Information:** UL 508, File E195399
- Pitch:** 17.8mm
- SCCR:** 10kA (default)
100kA (with upstream Class J 200A fuses)
- Max Current:** 100A (power feed from end;
200A (power feed from center)
- Max Voltage:** 600Vac/dc (three phase)
1000Vdc/600Vac (single phase)

Features and Benefits

- Easily distribute power in single-phase or three-phase configurations
- Flexible cut-to-length solutions without compromising on the product's finger-safe features
- 100kA SCCR (Short-Circuit Current Rating) when protected by a 200A Class J fuse
- Single-phase bus bars rated to 1000Vdc and 100A in end-fed configuration (200A for center-fed configuration)
- Three-phase bus bars rated to 600Vac/dc and 100A in end-fed configuration (200A for center-fed configuration)
- Power feed terminals for single-phase and three-phase service

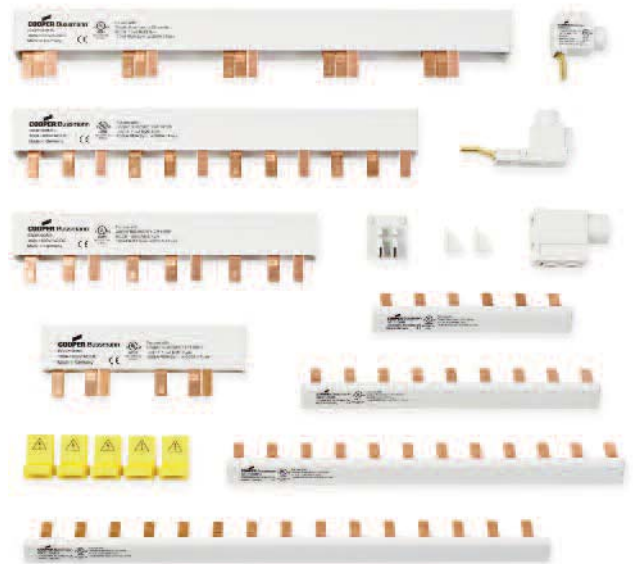

Selection Guide

Part Number	Description
BB1P100M3	Single-phase 1000Vdc busbar, 100A, 3 pins, assembled endcap
BB1P100M6	Single-phase 1000Vdc busbar, 100A, 6 pins, assembled endcap
BB1P100M9	Single-phase 1000Vdc busbar, 100A, 9 pins, assembled endcap
BB1P100M12	Single-phase 1000Vdc busbar, 100A, 12 pins, assembled endcap
BB1P100M15	Single-phase 1000Vdc busbar, 100A, 15 pins, assembled endcap
BB1P100M57	Single-phase 1000Vdc cuttable busbar, 100A, 57 pins, without endcap
BB3P100M6	Three-phase 600V busbar, 100A, 6 pins, assembled endcap
BB3P100M9	Three-phase 600V busbar, 100A, 9 pins, assembled endcap
BB3P100M12	Three-phase 600V busbar, 100A, 12 pins, assembled endcap
BB3P100M15	Three-phase 600V busbar, 100A, 15 pins, assembled endcap
BB3P100M57	Three-phase 600V cuttable busbar, 100A, 57 pins, without endcap
ECAP1P	Single-phase busbar endcap
ECAPMP	Three-phase busbar endcap
PWR35MM	35mm ² feeder terminal for three-phase busbar (115A, 1000Vac/dc)
FSCVR	Spare contact safety protection covers
PWR1PLP	Single-phase low-profile feeder terminal (115A, 1000Vac/dc)
PWR50MM	50mm ² direct feed terminal (1000Vac/dc)

For additional information see reorder #3185

Global Modular Fuse Holders - Comb-Bus Bar Features and Installation Guide

Typical Installation Example

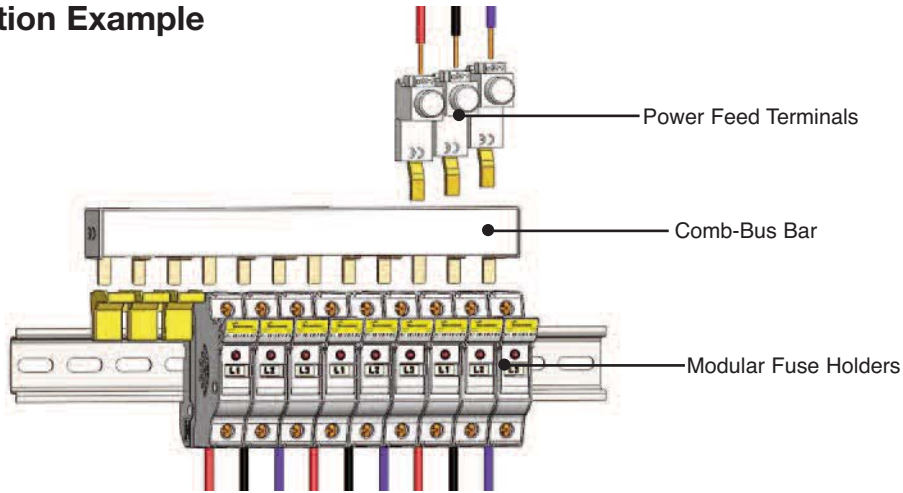

Typical Dimensional Data

Three-phase

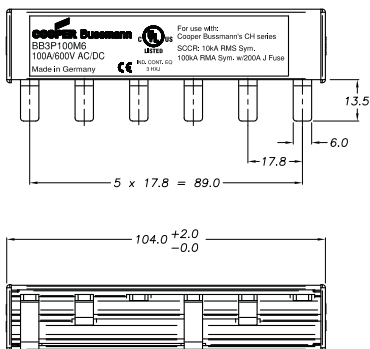

Single-phase

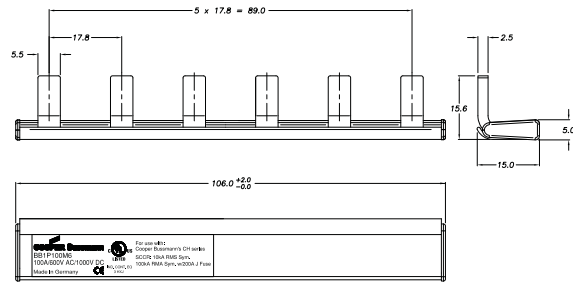

ECAP1P

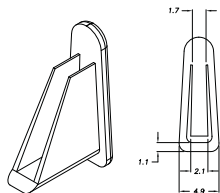

ECAPMP

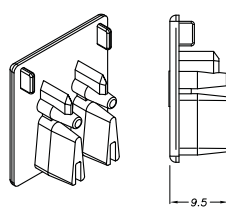

FSCVR

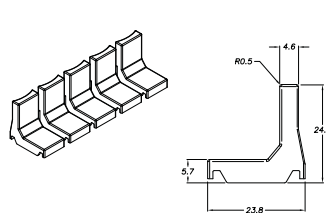

PWR1PLP

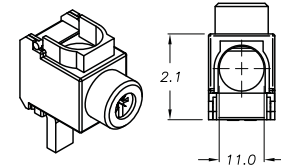

PWR35MM

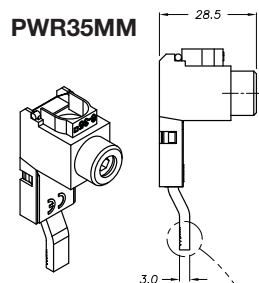

PWR50MM

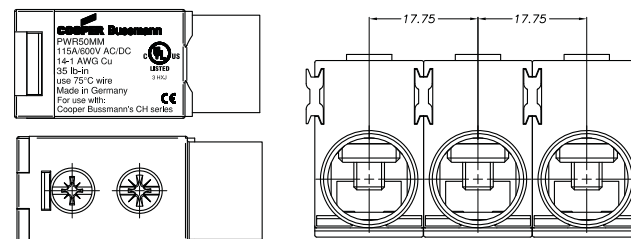

For additional information see reorder #3185

Class J Modular Fuse Holders

CH _ _ J _

Specifications

Description: IP20 finger-safe, 1- to 3-pole Class J fuse holder with DIN-Rail or panel mounting.

Ratings:

Volts: — 600Vac/dc (or less)

Amps: — 30A (30A version)

— 60A (60A version)

SCCR: — 200kA

Wire Range: Cu solid and stranded conductors with single (1-18AWG) and dual (3-18AWG) wire ratings. See Catalog Numbers table for details.

Torque Rating: 10-18AWG 24 lb-in.
1-8AWG 35 lb-in.

Poles: 1-, 2- or 3-Pole.

Storage & Operating Temperature Range*:

-20°C to 75°C.

Agency Information: CE, UL 4248/CSA 22.2 No. 4248.P
UL Listed, Guide IZLT, File E14853.

Flammability Rating: UL 94V0.

Catalog Numbers

See Catalog Numbers table below.

Features and Benefits

- Choice of local fuse indication; *easyID*™ viewing window (for seeing indicator on LPJ-SPI indicating fuse) or neon lamp.
- Versatile 1-, 2- and 3-pole versions for 0-30A and 35-60A fuses with dual wire rated connections simplify wiring.
- Improved electrical safety with IP20 finger-safe construction with lock-out/tag-out feature. 3-phase fuse extraction assures all phases are opened for service work.
- Flexible panel/35mm DIN-Rail mounting options

*For fuse selection on applications above or below 25°C, consult derating charts in Bussmann publication "Selecting Protective Devices" (SPD).



30 Amp Version

60 Amp Version

Dimensions (mm):

Fuse Size	Poles	W	D	H
0-30A	1	32	70	115
	2	64	70	115
	3	96	70	115
35-60A	1	40	83	125
	2	80	83	125
	3	120	83	125

Catalog Numbers

Catalog Numbers	# of Poles	Local Indication	Amp Rating	Volts (AC/DC)	IP20 Finger-Safe	AWG Single Wire Range	Padlockable	Mounting
CH30J1	1	<i>easyID</i> **	30	600	Yes	1-18	Yes	35mm DIN/ Panel
CH30J1I	1	Neon Lamp***						
CH30J2	2	<i>easyID</i> **						
CH30J2I	2	Neon Lamp***						
CH30J3	3	<i>easyID</i> **						
CH30J3I	3	Neon Lamp***						
CH60J1	1	<i>easyID</i> **	60	600	Yes	Yes	35mm DIN/ Panel	
CH60J1I	1	Neon Lamp***						
CH60J2	2	<i>easyID</i> **						
CH60J2I	2	Neon Lamp***						
CH60J3	3	<i>easyID</i> **						
CH60J3I	3	Neon Lamp***						

** *easyID*™ viewing window, requires use of Bussmann LPJ_SPI permanent indication fuses.

*** Indication non-fuse dependent, minimum voltage 90Vac/115Vdc.

Data Sheet: 2144

Optima™ Fuse Holder Module and Disconnect Switch

OPM-1038 With Disconnect Switch



Catalog Number Build-A-Code

Series	Fuse Type	Communication
OPM-1038	Blank SW	
	Blank = 10 x 38mm or 1 1/2" x 1 1/2"	C = Communication Feature
	R = Class CC	

Specifications

Description: 3-pole load break modular fuse holder and disconnect switch for 1 1/2" x 1 1/2" (10 x 38mm) fuses.

Dimensions: See Dimensions illustration.

Poles: 3

Agency Information: CE, UL (see table), CSA Certified, C22.2 No. 39, Class 6225-01, File 47235, IEC (see table).

Flammability Rating: UL 94V0.

Horsepower Rating of Switch

3-Phase	Volts	240	480	600
	HP	5	10	15

Recommended Fuse Types

Class CC	Midget (Non-Rejection)	European
LP-CC	KTK	C10M
KTK-R	FNM	C10G
FNQ-R	FNQ	

Physical Characteristics

- Small size matches 45mm IEC starter width
- Accepts #8-18 AWG stranded, #10-18 AWG solid wire
- 3-pole
- Handle and shaft required for through the door operation

Features/Benefits

- Padlockable with finger-safe terminals for safety. Qualified as IP20 per IEC 60529.
- Cam-action handle for easy module removal, offered with Class CC rejection clips or European 10 x 38mm clips to meet global needs
- Wire ready with 35mm DIN-Rail or screw panel mounting (#8 screw, 1 1/4" long) saves installation time
- Fuse indication lights with option for remote fuse status available. See Data Sheet for additional wiring details.

Typical Applications

- Industrial Control
- Process Control Systems
- Automated Warehouse Systems
- Individual Control Circuits

Dimensions

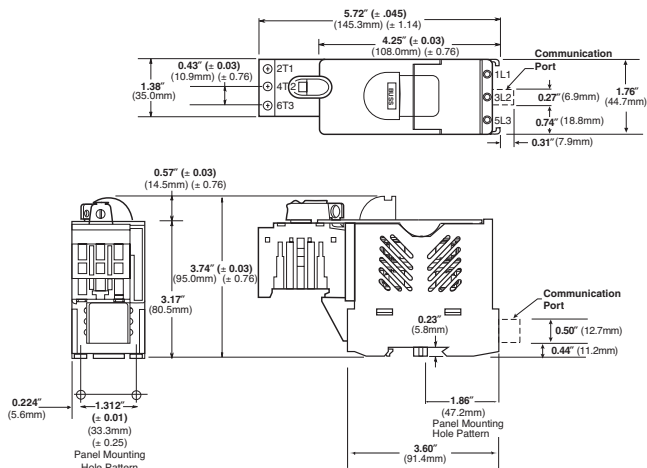

Catalog Numbers

Catalog Numbers	Electrical Rating	SCCR** Rating	Clips	Remote Open Fuse Indication	UL Information Std.	File	Guide	IEC	CE
OPM-1038SW	30A, 600Vac UL/CSA	*	Non-rejection, 10x38mm or 1 1/2" x 1 1/2"	No	Recognized	E161278	NLRV2	IEC 60947-3	Yes
	32A, 660Vac IEC								
OPM-1038RSW	30A, 600Vac UL/CSA	100kA	Rejection, Class CC	No	Listed UL 508	E161278	NLRV		Yes
OPM-1038SWC	30A, 600Vac UL/CSA	*	Non-rejection, 10x38mm or 1 1/2" x 1 1/2"	Yes	Recognized	E161278	NLRV2	IEC 60947-3	No
	32A, 660Vac IEC								
OPM-1038RSWC	30A, 600Vac UL/CSA	100kA	Rejection, Class CC	Yes	Listed UL 508	E161278	NLRV		No

*Rating varies depending on fuse used in module; 100kA maximum

**Short-Circuit Current Rating

Data Sheet: 1103

Optima™ Fuse Holder Module

OPM-1038



Catalog Number Build-A-Code

Series

O P M - 1 0 3 8

Fuse Type

Blank

Blank = 10 x 38mm or 1 3/32" x 1 1/2"

R = Class CC

Communication

C

C = Communication Feature

Specifications

Description: 3-pole modular fuse holder for 1 3/32" x 1 1/2" (10 x 38mm) fuses.

Dimensions: See Dimensions illustration.

Poles: 3

Agency Information: CE, UL (see table), CSA Certified, C22.2 No. 4248, Class 6225-01, File 47235, IEC (see table).

Flammability Rating: UL 94V0.

Recommended Fuse Types

Class CC	Midget (Non-Rejection)	European
LP-CC	KTK	C10M
KTK-R	FNM	C10G
FNQ-R	FNQ	

Physical Characteristics

- Small size matches 45mm IEC starter width
- Accepts #8-18 AWG stranded, #10-18 AWG solid wire
- 3-pole

Features/Benefits

- Padlockable with finger-safe terminals for safety. Qualified as IP20 per IEC 529.
- Cam-action handle for easy module removal.
- Offered with Class CC rejection clips or European 10 x 38mm clips to meet global needs
- Wire ready with 35mm DIN-Rail or screw panel mounting (#8 screw, 1 1/4" long) saves installation time
- Fuse indication lights with option for remote fuse status indication. See Data Sheet for additional wiring details.

Typical Applications

- Industrial Control
- Process Control Systems
- Automated Warehouse Systems
- Individual Control Circuits

Dimensions

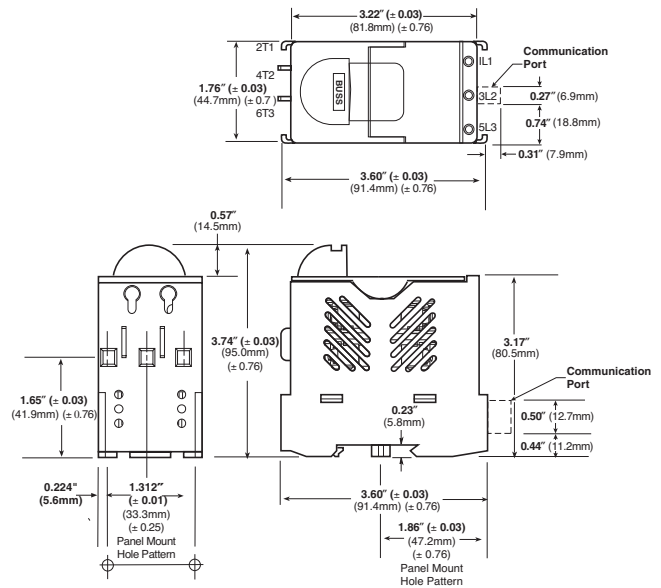

Catalog Numbers

Catalog Numbers	Electrical Rating	SCCR** Rating	Clips	Remote Open Fuse Indication	UL Information Std.	File	Guide	IEC	CE
OPM-1038	30A, 600Vac/dc UL/CSA (Max 3 Watts per fuse) 32A, 660V IEC	*	Non-rejection, 10 x 38mm or 1 3/32" x 1 1/2"	No	Recognized UL 4248	E14853	IZLT2	IEC 60269-2-1	Yes
OPM-1038R	30A, 600Vac/dc UL/CSA	200kA	Rejection, Class CC	No	Listed UL 4248	E14853	IZLT		Yes
OPM-1038C	30A, 600Vac/dc UL/CSA (Max 3 Watts per fuse) 32A, 660V IEC	*	Non-rejection, 10 x 38mm or 1 3/32" x 1 1/2"	Yes	Recognized UL 4248	E14853	IZLT2	IEC 60269-2-1	No
OPM-1038RC	30A, 600Vac/dc UL/CSA	200kA	Rejection, Class CC	Yes	Listed UL 4248	E14853	IZLT		No

*Rating varies depending on fuse used in module; 200kA maximum.

**Short-Circuit Current Rating

Data Sheet: 1102

Optima™ Three-pole Overcurrent Protection Module

OPM-NG-



Specifications

Description:

OPM-NG-SC3: 3-pole Class CC fuse holder for use with Class CC fuses (Bussmann Types LP-CC, FNQ-R, KTK-R).

OPM-NG-SM3: 3-pole fuse holder for use with 1½" x 1½" and 10.3 x 38mm fuses (Bussmann Types: 1½" x 1½"; KTK, FNQ, KLM, 10 x 38mm; FWA, FWC, C10G_ , C10M_).

Ratings:

- Volts: — OPM-NG-SC3: 600Vac (or less)
 — OPM-NG-SM3: 600Vac (or less) UL and CSA 30A
 — OPM-NG-SM3: 690Vac (or less) IEC 32A
- Amps: — OPM-NG-SC3: 0-30A
 — OPM-NG-SM3: 0-30A
- SCCR: — OPM-NG-SC3: 200kA
 — OPM-NG-SM3: Same as fuse IR, 200kA maximum

Agency Information: CE, UL; OPM-NG-SC3 UL Listed, UL 4248, File E14853, Guide IZLT. OPM-NG-SM3, UL Recognized, UL 4248, File E14853, Guide IZLT2. CSA Certified, C22.2 No. 4248, Class 6225-01, File 47235. IEC 60947-3 Utilization Category AC20B.

Handling & Storage Temperature: -10° to 65°C.

Features/Benefits

- 45mm width matches IEC starters
- 35mm DIN-Rail or panel mounting feature. Maximum screw size #8 (M4)
- Pressure plate terminations with dual-wire rated terminals (see Wire Table) and optional auxiliary contacts
- Integrated collapsible handle and fuse carrier cannot be removed from holder base
- Padlockable and IP20 finger-safe to IEC60529

Typical Applications

- Mass Produced Control Systems
- Process Control Systems
- Automated Warehouse Systems
- Individual Control Circuits

Fuse Holder Wire Range:

- 75°Cu Only
- #18-12 Single/Dual, torque 15lb-in
- #10-8 Single/Dual, torque 20lb-in
- Dual wire with same gauge and type

		75° Cu Only		C (N·m)/lb-in
		AWG	[mm ²]	
Solid		#18-8 x 1	1-6 x 1	18-12 Single/Dual 15lb-in (1.7 N·m)
		#18-8 x 2	1-6 x 2	
Stranded		#18-8 x 1	1-6 x 1	10-8 Single/Dual
		#18-8 x 2	1-6 x 2	
Ferrules			1-4 x 1	20lb-in (2.5 N·m)
			1-4 x 2	

Input Power Terminal Wire Range:

Wiring	Solid Conductor	(1) #14 to #2 (1.5 to 25mm ²) conductor or (2) #14 to #6 (1.5 to 10mm ²) conductors
	Stranded Conductor	(1) #14 to #2 (1.5 to 25mm ²) conductor or (2) #12 to #6 (2.5 to 10mm ²) conductors
Tightening Torque:	Connector	20lb-in (2.2 N·m)
	Screw Clamp	15lb-in (1.7 N·m)

Materials:

- **Housing:** Thermoplastic - ULV2
- **Clip:** Tin-plated copper alloy
- **Contact lubricant:** Fluoroether grease
- **Saddle screw:** Plated steel
- **DIN rail springs:** Stainless steel

Optional Accessories:

Comb Bar (Max current rating = 63A)

GV2G245A46	2 circuit, 45mm between same phases
GV2G254A46	2 circuit, 54mm between same phases
GV2G272A46	2 circuit, 72mm between same phases
GV2G345A46	3 circuit, 45mm between same phases
GV2G354A46	3 circuit, 54mm between same phases
GV2G445A46	4 circuit, 45mm between same phases
GV2G454A46	4 circuit, 54mm between same phases
GV2G472A46	4 circuit, 72mm between same phases
GV2G554A46	5 circuit, 54mm between same phases

Input Terminal Block (Max current rating = 63A)

GV2G05	Input/Feed Through Power Terminal, Supports feed through to another system, DIN-Rail mount only
GVG09	Input Power Terminal

Cover

GV1G10	Protective Cover for unused terminals on comb bar
--------	---

Auxiliary Contacts

GVAE11	NO/NC
GVAE20	NO/NO

Optima™ Three-pole Overcurrent Protection Module

Optional Accessories

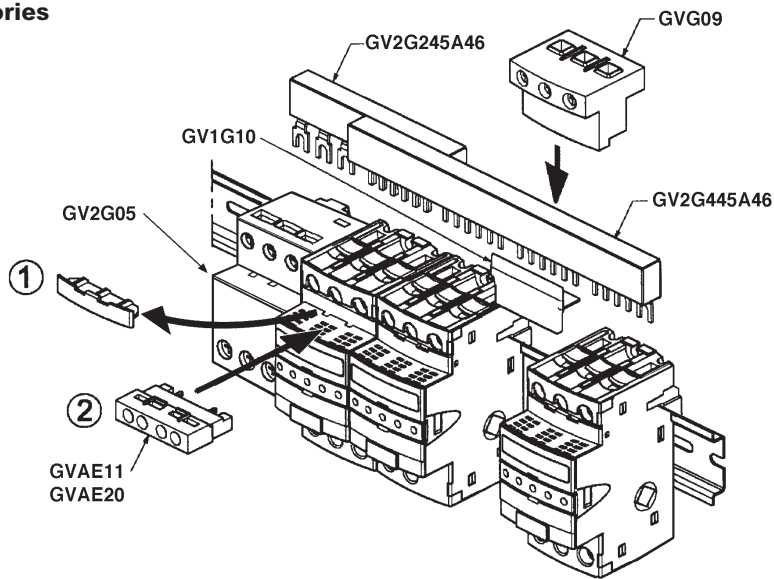

Dimensions - mm (± 0.38) / in (± .015)

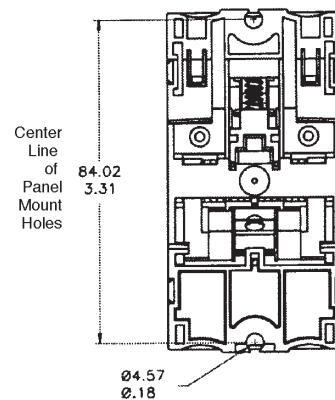
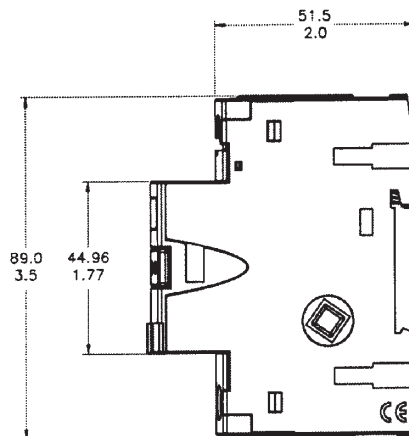
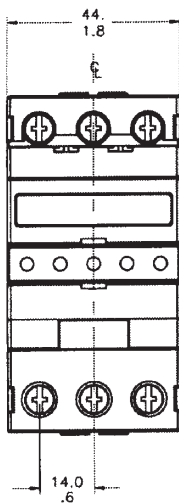
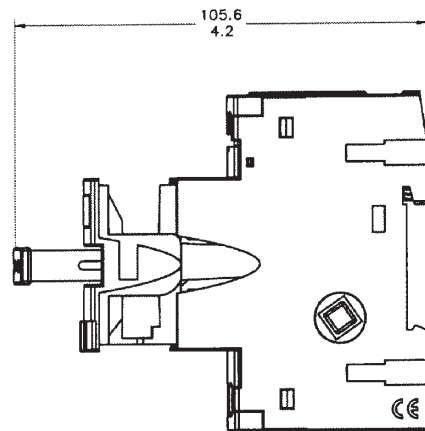
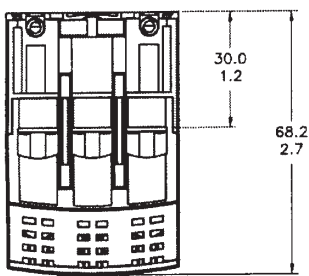

Class J (Finger-safe) Fuse Holders

Safety J™ — JT(N)60030 & JT(N)60060

Specifications

Description: Indicating and non-indicating finger-safe, DIN-Rail mount fuse holders for use with Class J fuses - (Bussmann LPJ, JKS).

Dimensions: See Dimensions illustrations.

Ratings:

Volts: — 600Vac

Amps: — 0-60A (JT(N)60060)

— 0-30A (JT(N)60030)

SCCR: — 200kA RMS Sym.

— 300kA self certified using Bussmann LPJ_SP fuses

Agency Information: CE, Listed to UL 4248: Guide IZLT, File 14853, CSA Certified: Class 6225-01, File 47235. IP20 per IEC 60529.

Flammability Rating: UL 94V0.

Indication: Min voltage: 90Vac, 115Vdc; neon lamp “ON” when fuse opens, voltage source and current path are present.

Terminations: 30A dual port torque 20lb-in, 60A single port torque 45lb-in, terminal construction, tin-plated copper alloy.

Wire Size: JT(N)60030 - rated for 75°C, AWG#18-#8; Cu only, JT(N)60060 - rated for 75°C, AWG#14-#4; Cu only.

(Note: For JT(N)60030 use both stranded or solid, in a variety of dual wire combinations of same wire size and type.)

Features and Benefits

- Short-Circuit Current Rating of 300kA with Bussmann LPJ__SP fuses.
- Rapid, flexible 35 mm DIN-Rail mounting.
- One piece interlocking design for assembling multiple pole blocks reduces inventory costs.
- Removable fuse carrier allows fuse replacement away from base while maintaining finger-safe rating.

Typical Applications

- Industrial Controls
- Process Controls
- Small HP VFDs

Catalog Numbers

Catalog Numbers	Amps	Indication
JT60030	30	Non-indicating
JT60060	60	Non-indicating
JTN60030	30	Indicating (Neon)
JTN60060	60	Indicating (Neon)



30 Amp Version



60 Amp Version

Data Sheet: 1152

Class J (Finger-safe) Fuse Holders

Dimensions for JT60030 & JTN60030 — in (mm)

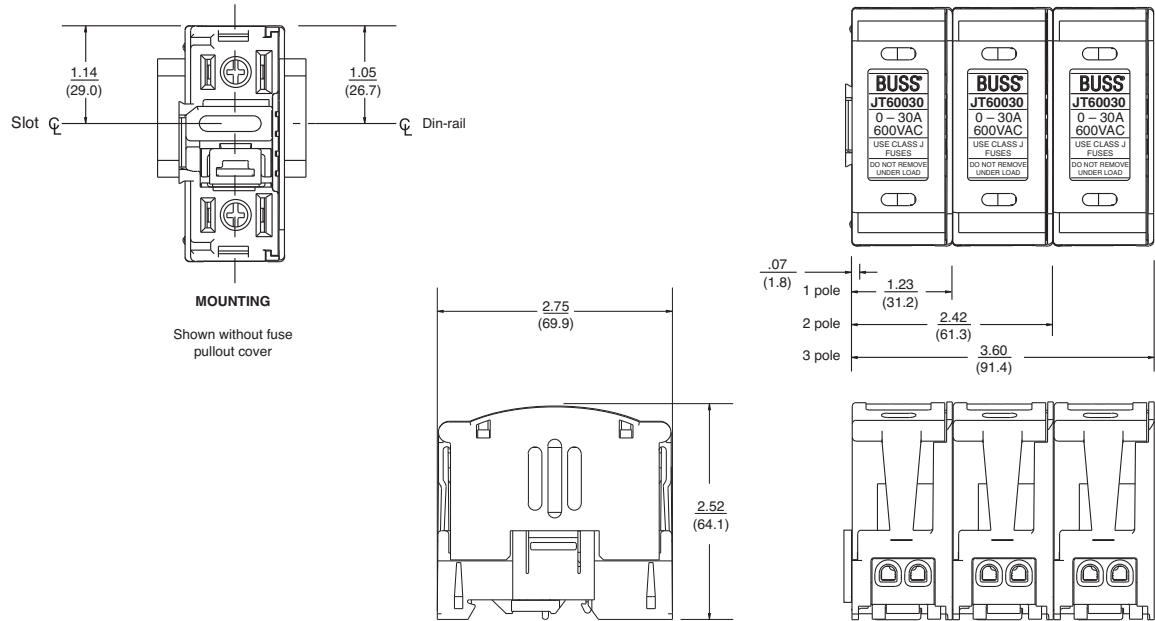

Dimensions for JT60060 & JTN60060 — in (mm)

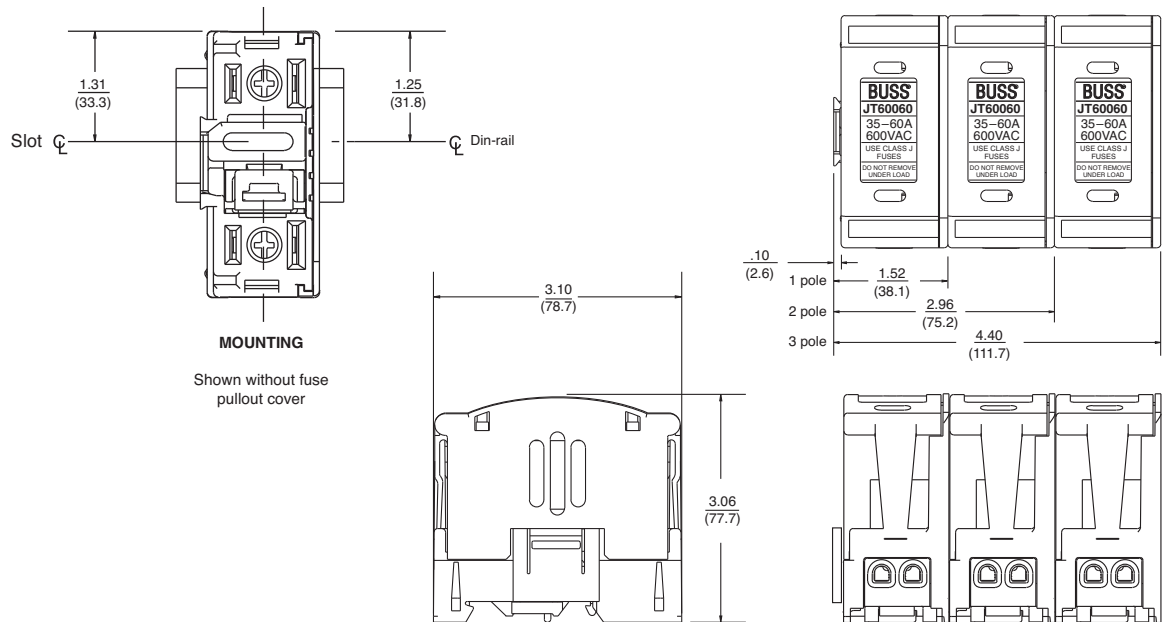

JT(N)600 Series fuse blocks can be dovetailed together within the same current rating to provide multiple pole block configurations.

NOTE: JT(N)60030 cannot be dovetailed to JT(N)60060.

Data Sheet: 1152

SAMI™ Fuse Covers

SAMI™ Series



Specifications

Description: Indicating and non-indicating fuse covers for Class J, RK1, RK5, H, K5, CC, G (0-30A) and midget-type fuses. Indicating feature requires a minimum of 90Vac or 115Vdc to illuminate lamp. One cover required for each pole.

WARNING: To avoid electrical shock, turn power off before installing, removing or servicing.

Dimensions: See Dimensions illustration.

Ratings:

Volts: — Non-Indicating - 0-600Vac/dc
 — Indicating - 90 to 600Vac
 -115 to 600Vdc

Amps: — 0-100A

Agency Information: CE, UL Listed; SAMI-1I through SAMI-6I, SAMI-8I and SAMI-9I, SAMI-1N through SAMI-6N, SAMI-8N and SAMI-9N, UL Recognized; Guide JDVS2, File E58836, SAMI-7I and SAMI-7N, CSA Certified, File LR47235-93C.

Catalog Numbers

Catalog Numbers*	Description	Dimensions - in		
		A	B	C
SAMI-1_	600V, J (0-30A) and 600V, T (35-60A)** 250V, RK, K5, H (35-60A)	5.02	1.03	1.94
SAMI-2_	600V, RK, K5, H (0-30A)	7.03	1.30	2.07
SAMI-3_	600V, J (65-100A)	7.03	1.30	2.33
SAMI-4_	250V, RK, K5, H (65-100A)	8.20	1.30	2.18
SAMI-5_	600V, RK, K5, H (35-60A)	8.20	1.30	2.18
SAMI-6_	600V, J (35-60A)	4.98	1.17	2.14
SAMI-7_	600V, Midget, Class CC, G (0-30A)	3.82	0.75	1.72
SAMI-8†_	600V, RK††, K5, H (65-100A)	10.38	1.50	2.33
SAMI-9_	250V, RK, K5, H (0-30A) and 600V, T (0-30A)	3.82	0.75	1.72

*For indicating cover, add suffix "I", for non-indicating cover, add suffix "N".

Example: SAMI-7I = Indicating, SAMI-7N = Non-indicating.

**Available in non-indicating only.

†SAMI-8A adapter available for small Fusetron™ body design. SAMI-8I and SAMI-8N come standard with adapter (SAMI-8A).

††Not for use with KTS-R fuses.

Features and Benefits

- Insulated cover allows field conversion of fuses mounted in open fuse blocks to dead front configuration.
- Optional open fuse indicating light aids in system troubleshooting.
- Units are re-usable.
- Allows visual marking of line and load side of fuses.

Typical Applications

- Class H, R and J fuse blocks up to 100A
- Class T fuse blocks up to 60A
- Class CC, G and Midget, 30A fuse blocks

Dimensions

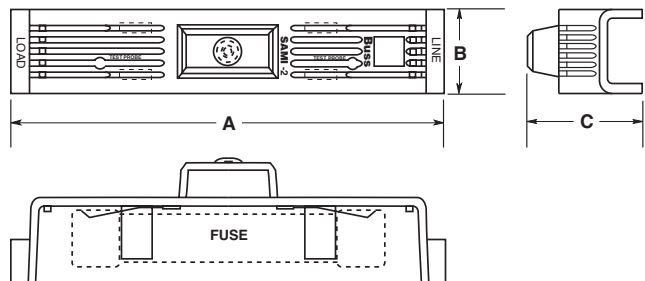

Modular Knifeblade Fuse Blocks

Class R, H(K), & J Applications up to 600 Amps

Specifications

Ratings:

Volts: — 250V, 600V
 Amps: — 70-600A
 SCCR: — 200kA (Class R & J)
 10kA (Class H & K)

Agency Information:

Blocks: UL - Listed cULus
 E14853 – IZLT & IZLT7
 CSA - Certified 47235 –
 6225-01

Covers: UL - Listed UL
 E58836 – JDVS2
 CSA - Certified 47235 –
 6225-01

Flammability Ratings:

Blocks: UL 94V0, self-extinguishing
Covers: UL 94HB, self-extinguishing

Operating & Storage Temperature Range:

Blocks -40°C to 120°C
Covers non-indicating covers -40°C to 120°C
 indicating covers -20°C to 90°C

Materials:

Base – Thermoplastic
 Box Lug – Tin-plated aluminum

Wire:*

Cu/Al – 75°C/90°C (100 - 200A)
 Cu/Al – 75°C only (400 - 600A)

*Higher temperature rated wire can be used with appropriate derating.



Features and Benefits

- Integral dovetails allow snapping together multiple poles at point-of-use for greater application flexibility
- Factory assembled two- and three-pole configurations available
- Up to four mounting holes per pole increase installation flexibility
- Standard phase barriers between poles for additional safety
- Design meets UL creep and clearance requirements for Industrial Control Circuits (UL 508 and UL 845)
- 200 to 600A blocks meet the higher UL creep and clearance requirements for Industrial Power Distribution Standards (UL 98, UL 69, UL 489, UL 891 and UL 869A)
- Optional IP20 finger-safe covers available on entire knifeblade fuse block product line:
 - High-clarity see-through covers allow for inspecting wire terminations or thermography measurements without removing cover
 - Probe holes included for easy, safer testing and troubleshooting
 - Built-in lockout/tagout feature improves safety
- Standard fuse clip reinforcing springs enhance electrical contact

Typical Applications

- Critical power, factory automation, renewable energy, HVAC, building/elevator controls, building entrance, process industries



Scan this tag to get the latest product information for the Modular Knifeblade Fuse Blocks.

Modular Knifeblade Fuse Blocks Part Number Table



250V Class R & H(K)



600V Class R & H(K)



Class J

Catalog Number		Covers*		Volts	Fuse Range (amps)	Number of Poles	Wire Range (solid and stranded)***	Wire Range (fine stranded Cu)	Torque N•m (Lb-in)	Cooper Bussmann Fuses			
Class H(K)	Class R	w/o Indication	w/ Indication										
HM25100-1CR	RM25100-1CR	CVR-RH-25100	CVRI-RH-25100	250	70-100	1	–	1-3 AWG	6.2 (55)	Class H(K): NON			
HM25100-2CR	RM25100-2CR					2	1/0-3 AWG; (2) Cu 4-6 AWG	4-6 AWG	5.6 (50)				
HM25100-3CR	RM25100-3CR					3	4-6 AWG; (2) Cu 8 AWG	8 AWG	4.5 (40)				
HM25200-1CR	RM25200-1CR	CVR-RH-25200	CVRI-RH-25200		110-200	1	250 MCM-1 AWG	3/0-1 AWG	42 (375)		Class R: LPN-RK_SP PN-RK_SPI**		
HM25200-2CR	RM25200-2CR					2	2-6 AWG; (2) Cu 2-6 AWG	2-6 AWG	31 (275)				
HM25200-3CR	RM25200-3CR												
HM25400-1CR	RM25400-1CR	CVR-RH-25400	CVRI-RH-25400		250	225-400	1	600kcmil	N/A			57 (500)	FRN-R KTN-R
HM25400-2CR	RM25400-2CR						2	500kcmil-4 AWG				51 (450)	
HM25400-3CR	RM25400-3CR						3	(2) Cu 3/0 - 4 AWG				57 (500)	
HM25600-1CR	RM25600-1CR	CVR-RH-25600	CVRI-RH-25600	450-600		1	(2) 500kcmil-4 AWG	N/A	51 (450)				
HM25600-2CR	RM25600-2CR					2							
HM25600-3CR	RM25600-3CR					3							
HM60100-1CR	RM60100-1CR	CVR-RH-60100	CVRI-RH-60100	600		70-100	1	–	1-3 AWG		6.2 (55)	Class H(K): NOS	
HM60100-2CR	RM60100-2CR						2	1/0-3 AWG; (2) Cu 4-6 AWG	4-6 AWG		5.6 (50)		
HM60100-3CR	RM60100-3CR						3	4-6 AWG; (2) Cu 8 AWG	8 AWG		4.5 (40)		
HM60200-1CR	RM60200-1CR	CVR-RH-60200	CVRI-RH-60200		110-200	1	250 MCM-1 AWG	3/0-1 AWG	42 (375)		Class R: LPS-RK_SP PS-RK_SPI**		
HM60200-2CR	RM60200-2CR					2	2-6 AWG; (2) Cu 2-6 AWG	2-6 AWG	31 (275)				
HM60200-3CR	RM60200-3CR												
HM60400-1CR	RM60400-1CR	CVR-RH-60400	CVRI-RH-60400		600	225-400	1	600kcmil	N/A	57 (500)			FRS-R KTS-R KWS-R PVS-R
HM60400-2CR	RM60400-2CR						2	500kcmil-4 AWG		51 (450)			
HM60400-3CR	RM60400-3CR						3	(2) Cu 3/0 - 4 AWG		57 (500)			
HM60600-1CR	RM60600-1CR	CVR-RH-60600	CVRI-RH-60600	450-600		1	(2) 500kcmil-4 AWG	N/A	51 (450)				
HM60600-2CR	RM60600-2CR					2							
HM60600-3CR	RM60600-3CR					3							

Catalog Number	Covers*		Volts	Fuse Range (amps)	Number of Poles	Wire Range (solid and stranded)	Wire Range (fine stranded)	Torque N•m (Lb-in)	Cooper Bussmann Fuses		
Class J	w/o Indication	w/ Indication									
JM60100-1CR	CVR-J-60100	CVRI-J-60100	600	70-100	1	–	1-3 AWG	6.2 (55)	LPJ_SP PJ_SPI** JKS DFJ		
JM60100-2CR					2	1/0-3 AWG; (2) Cu 4-6 AWG	4-6 AWG	5.6 (50)			
JM60100-3CR					3	4-6 AWG; (2) Cu 8 AWG	8 AWG	4.5 (40)			
JM60200-1CR	CVR-J-60200	CVRI-J-60200		110-200	1	250 MCM-1 AWG	3/0-1 AWG	42 (375)			
JM60200-2CR					2	2-6 AWG; (2) Cu 2-6 AWG	2-6 AWG	31 (275)			
JM60200-3CR											
JM60400-1CR	CVR-J-60400	CVRI-J-60400		225-400	1	600kcmil	N/A	57 (500)			
JM60400-2CR					2	500kcmil-4 AWG		51 (450)			
JM60400-3CR					3	(2) Cu 3/0 - 4 AWG		57 (500)			
JM60600-1CR	CVR-J-60600	CVRI-J-60600	450-600	1	(2) 500kcmil-4 AWG	N/A	51 (450)				
JM60600-2CR				2							
JM60600-3CR				3							

*Covers sold separately. Blown fuse indication requires 90 volts minimum and closed circuit to operate.

**With *easyID™* blown fuse indication.

***Ratings for copper and aluminum wire except where otherwise noted.

250V Class R & H(K) Dimensional Specifications

Dimensions - mm (in)

70-100A

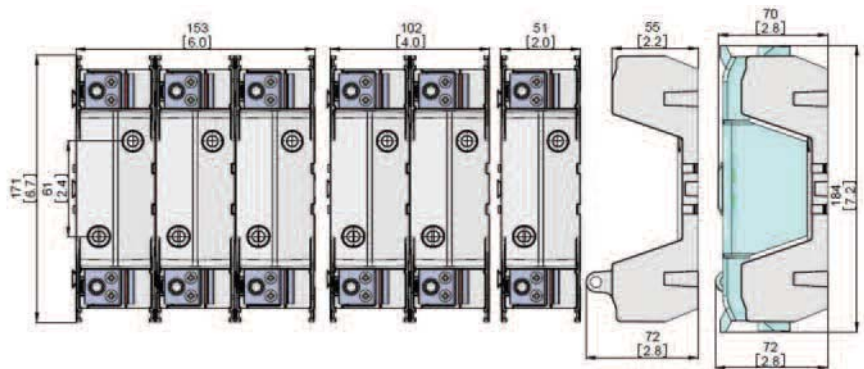
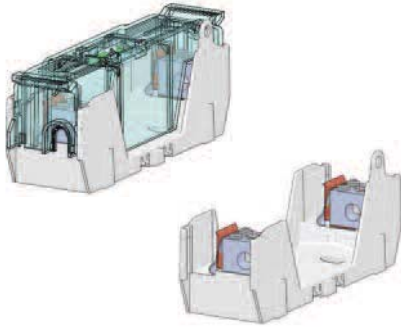

110-200A

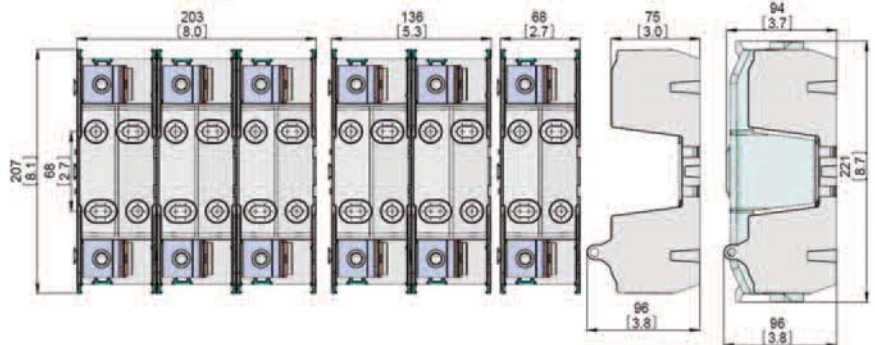
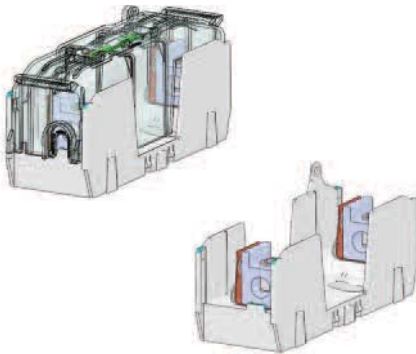

225-400A

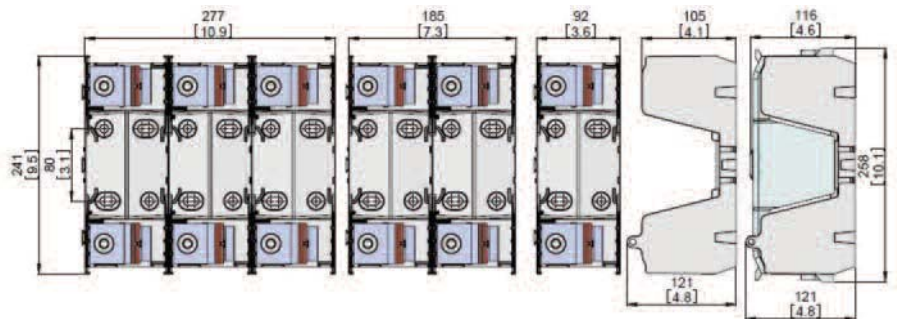
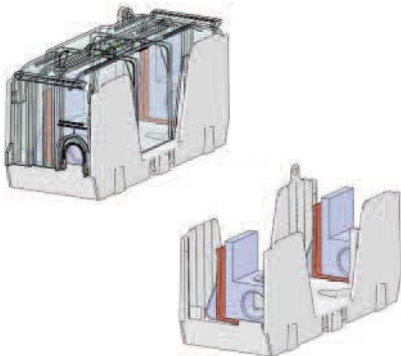

450-600A

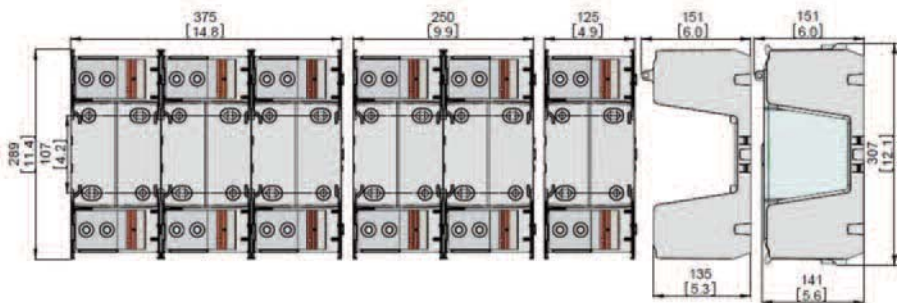
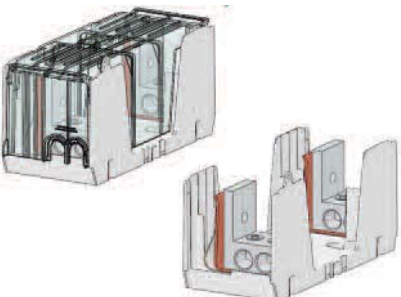

600V Class R & H(K) Dimensional Specifications

Dimensions - mm (in)

70- 100A

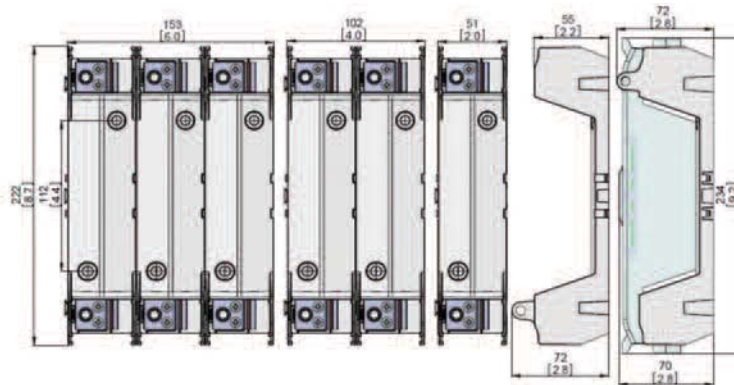
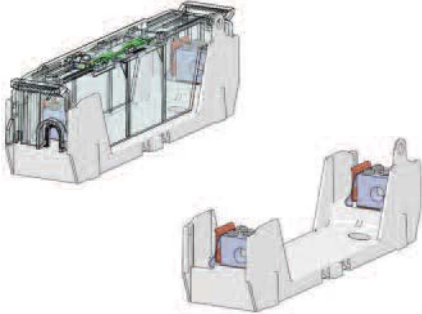

110- 200A

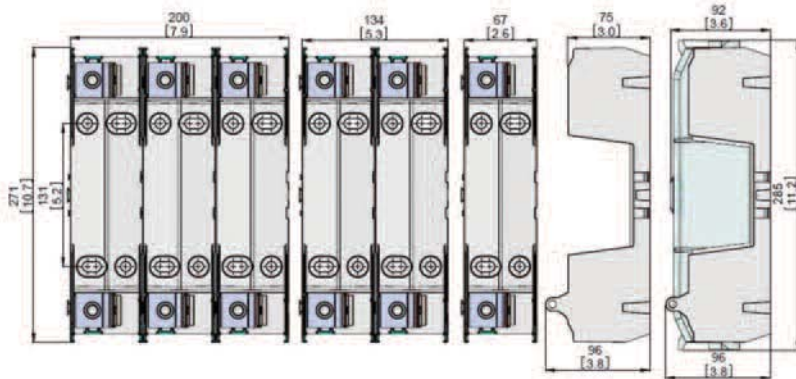
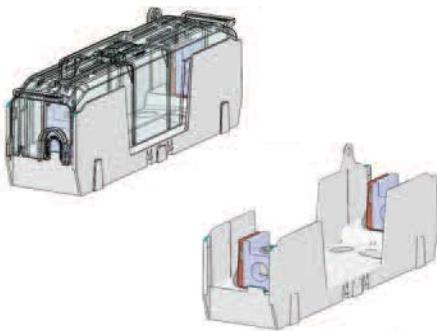

225- 400A

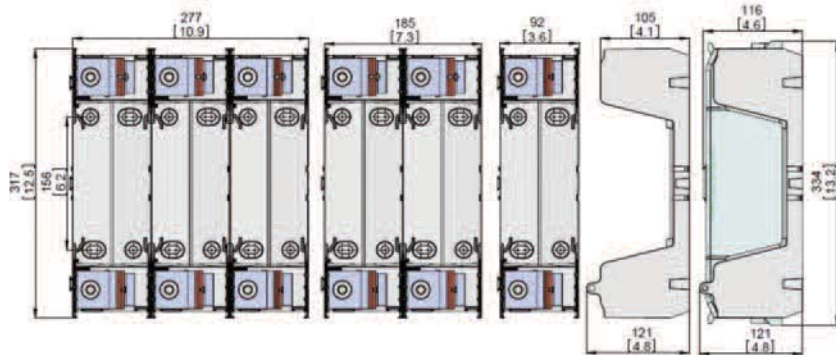
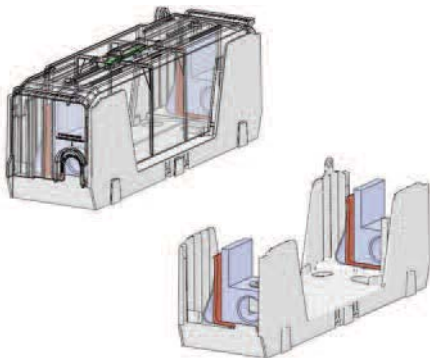

450- 600A

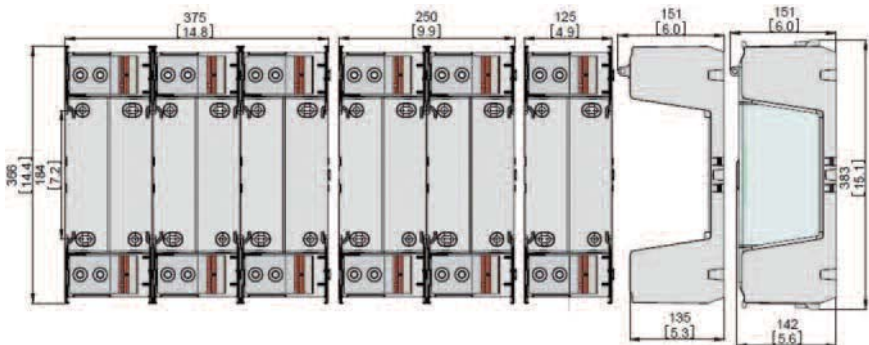
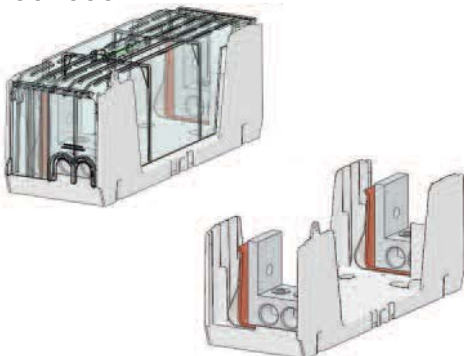

Class J Dimensional Specifications

Dimensions - mm (in)

70-100A

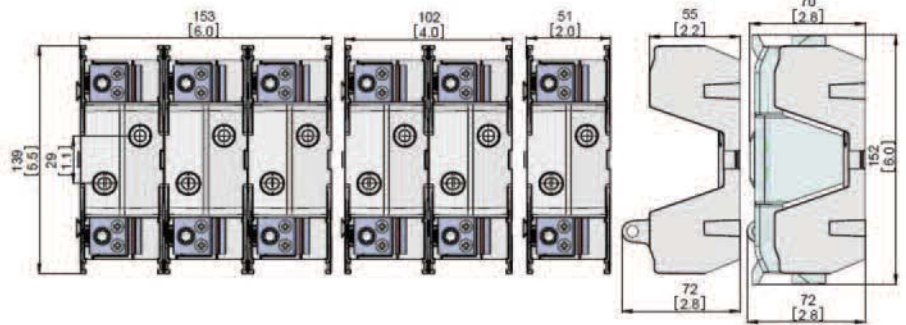
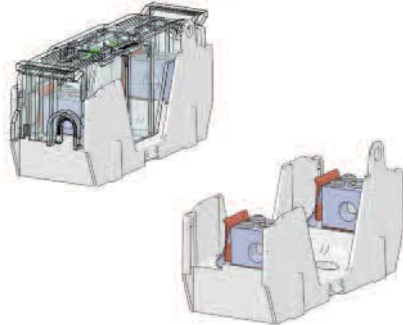

110-200A

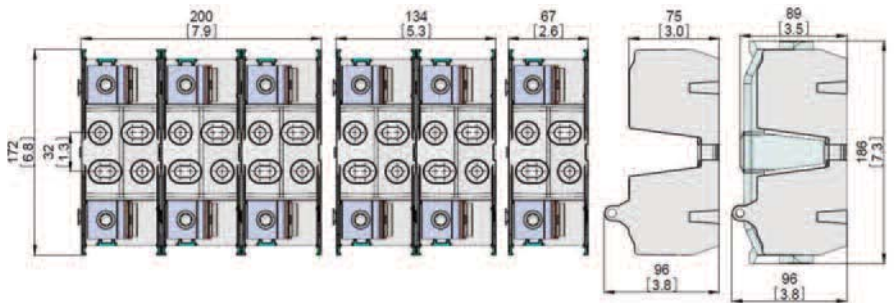
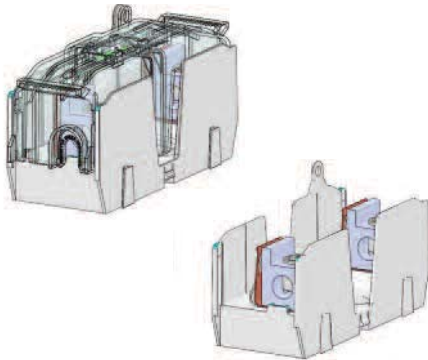

225-400A

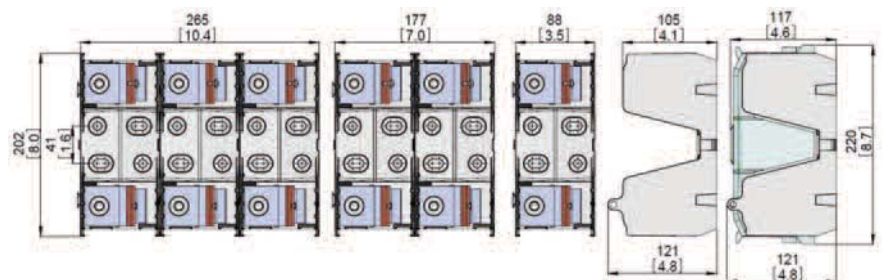
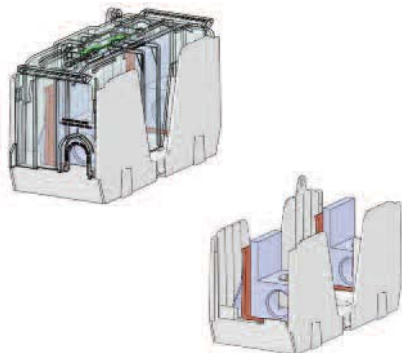

450-600A

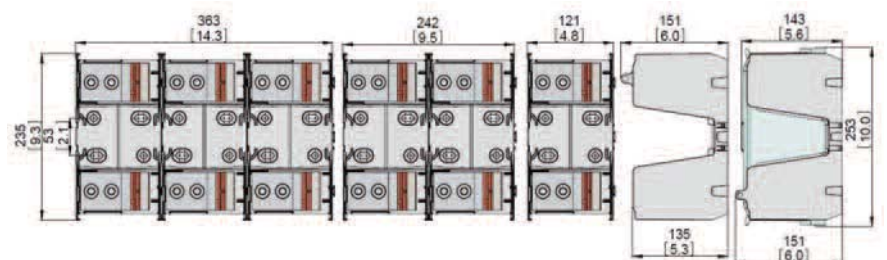
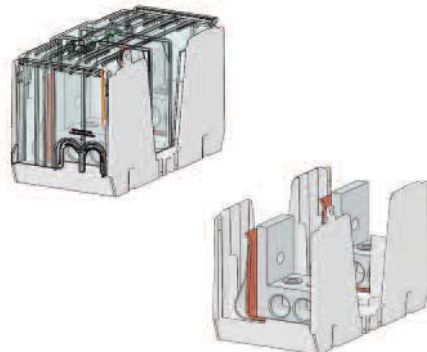

Class H(K) and R Fuse Blocks – 250V

H250 & R250 Series

Specifications

Descriptions:

H250 Series: 1-, 2- and 3-pole fuse blocks for use with Class H fuses.

R250 Series: 1-, 2- and 3-pole fuse blocks for use with Class R fuses (Bussmann LPN-RK and FRN-R and KTN-R fuses).

Dimensions: See Dimensions illustrations.

Ratings:

Volts: — 250Vac/dc (H250 & R250 Series)

Amps: — 1/10-100A

SCCR: — H250 Series; 10kA RMS Sym.

— R250 Series; 200kA RMS Sym.



Agency Information: CE, UL Listed UL 4248, Guide IZLT, File E14853; CSA Certified, Class 6225-01, File 47235.

Flammability Rating: UL 94V0.

Features and Benefits

- H250 fuse blocks provide one, two and three pole housing for Class H, K and R fuses at 250Vac.
- H250 fuse blocks are listed with a Short-Circuit Current Rating of 10kA RMS Sym.
- R250 fuse blocks provide 1-, 2- and 3-pole housing for Class R fuses at 250Vac.
- R250 fuse blocks are listed with a Short-Circuit Current Rating of 200kA RMS Sym.

Typical Applications

- 250Vac/dc or less Control Systems
- 250Vac/dc or less Industrial Control
- 250Vac/dc or less Industrial Control Circuits

Recommended DIN-Rail adapters for the 1/10-30A series

- see page 509.

Class H Fuseblocks (250V) Catalog Data (for NON and REN Fuses)

Amps	Poles	Terminal Type (Suffix No.)										Figure Number	Wire Range
		Screw					Box Lug w/						
		Catalog Number	—	Clip with Reinforced Spring	Pressure Plate	Pressure Plate & Clip with Reinforced Spring	—	Clip with Reinforced Spring	Copper Only	0.25" Quick Connect			
1/10 to 30	1	H25030-1	S	SR	P	PR	C	CR	—	Q	1	C, CR #2-14 Cu, #2-12 Al P, PR #10-18 Cu Only Q N/A S, SR #10-18 Cu Only	
	2	H25030-2	S	SR	P	PR	C	CR	—	—	2		
	3	H25030-3	S	SR	P	PR	C	CR	—	—	3		
31 to 60	1	H25060-1	—	—	—	—	C	CR	CO	—	4	C, CR #2-14 Cu, #2-8 Al CO #2-14 Cu Only	
	2	H25060-2	—	—	—	—	C	CR	CO	—	5		
	3	H25060-3	—	—	—	—	C	CR	CO	—	6		
61 to 100	1	H25100-1	—	SR	—	—	—	CR	—	—	7	CR #1/0-8 Cu/Al SR #8W/ Ring Terminal	
	2	H25100-2	—	SR	—	—	—	CR	—	—	8		
	3	H25100-3	—	SR	—	—	—	CR	—	—	9		

Class H(K) and R Fuse Blocks – 250V

Class R Fuseblocks (250V) Catalog Data (for LPN-RK, FRN-R and KTN-R Fuses)

Amps	Poles	Catalog Number	Terminal Type (Suffix No.)				Fig. No.	Wire Range	
			Screw w/	Pres. Plate	Box Lug w/	0.25" Quick-Connect			
1/2 to 30	1	R25030-1	SR	PR	CR	COR	QR*	1	COR #6-14 Cu Only
	2	R25030-2	SR	PR	CR	COR	—	2	CR #2-14 Cu, #2-12 Al
	3	R25030-3	SR	PR	CR	COR	—	3	PR #10-18 Cu Only QR N/A SR #10-18 Cu Only
31 to 60	1	R25060-1	—	—	CR	—	—	4	CR #2-14 Cu, #2-8 Al
	2	R25060-2	—	—	CR	—	—	5	
	3	R25060-3	—	—	CR	—	—	6	
61 to 100	1	R25100-1	—	—	CR	—	—	7	CR 1/0-8 Cu/Al
	2	R25100-2	—	—	CR	—	—	8	
	3	R25100-3	—	—	CR	—	—	9	

Dimensions - in 250V 1/2 to 30A

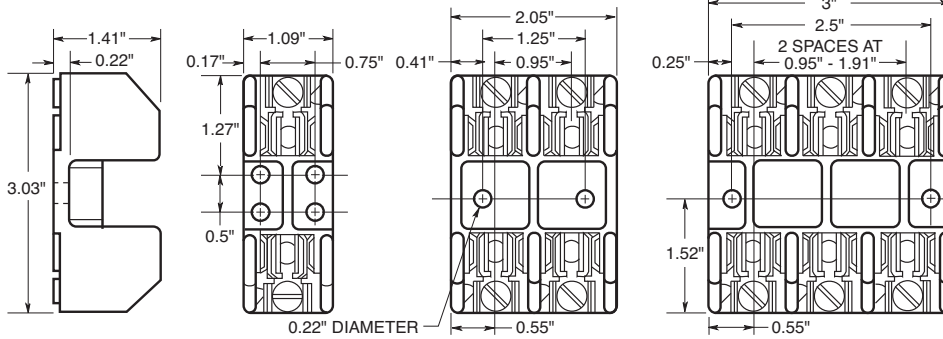

FIGURE 1.

FIGURE 2.

FIGURE 3.

250V, 31A to 60A

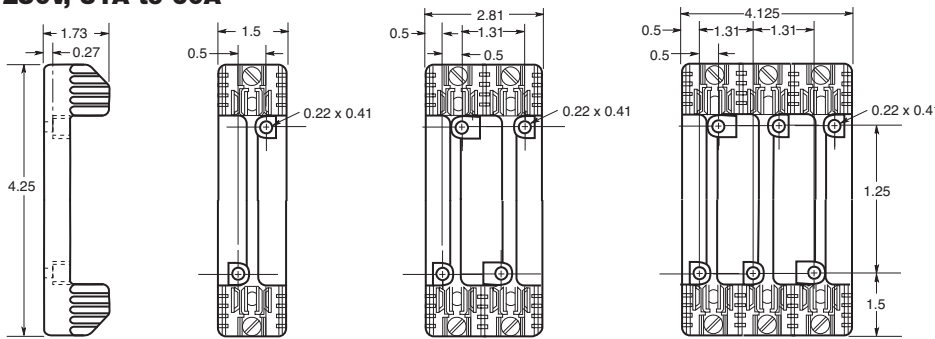

FIGURE 4.

FIGURE 5.

FIGURE 6.

250V, 61A to 100A

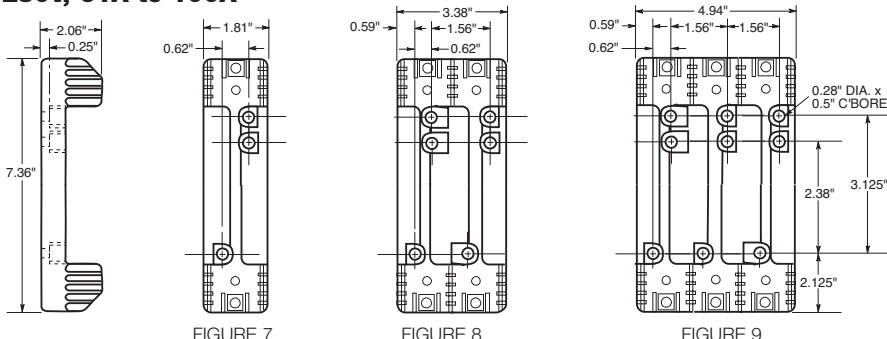

FIGURE 7.

FIGURE 8.

FIGURE 9.

Data Sheet: H250 Series, 1112; R250 Series, 1110

For product data sheets, visit www.cooperbussmann.com/DatasheetsEle

Class H(K) and R Fuse Blocks – 600V

H600 & R600 Series

Specifications

Descriptions:

H600 Series: fuse blocks for use with 1-, 2- and 3-pole Class H fuses.

R600 Series: fuse blocks for use with 1-, 2- and 3-pole Class R fuses (Bussmann LPS-RK, FRS-R, PVS-R and KTS-R fuses).

Dimensions: See Dimensions illustrations.

Ratings:

Volts: — 600Vac/dc (H600 & R600 Series)

Amps: — 1/10-100A

SCCR: — H600 Series; 10kA RMS Sym.

— R600 Series; 200kA RMS Sym.

Agency Information: CE, UL Listed UL 4248, Guide IZLT, File E14853; CSA Certified, Class 6225-01, File 47235.

Flammability Rating: UL 94V0.



H60030-3C



H60030-2PR

Features and Benefits

- H600 fuse blocks provide one-, two- and three-pole housing for Class H, K and R fuses at 600Vac.
- H600 fuse blocks are listed with a Short-Circuit Current Rating of 10kA RMS Sym.
- R600 fuse blocks provide one-, two- and three-pole housing for Class R fuses at 600Vac.
- R600 fuse blocks are listed with a Short-Circuit Current Rating of 200kA RMS Sym.

Typical Applications

- 600Vac/dc or less Control Systems
- 600Vac/dc or less Industrial Control
- 600Vac/dc or less Individual Control Circuits

Class H Fuseblocks (600V) Catalog Data (for NOS and RES Fuses)

Amps	Poles	Terminal Type (Suffix No.)							Figure Number	Wire Range
		Catalog Number	Screw			Box Lug w/				
			—	Clip with Reinforced Spring	Pressure Plate	Pressure Plate & Clip with Reinforced Spring	—	Clip with Reinforced Spring		
1/10 to 30	1	H60030-1	S	SR	P	PR	C	CR	1	C, CR #2-14 Cu, #2-12 Al P, PR, S, SR #10-18 Cu Only
	2	H60030-2	S	SR	P	PR	C	CR	2	
	3	H60030-3	S	SR	P	PR	C	CR	3	
31 to 60	1	H60060-1	—	—	—	—	C	CR	4	C, CR #2-14 Cu, #2-8 Al
	2	H60060-2	—	—	—	—	C	CR	5	
	3	H60060-3	—	—	—	—	C	CR	6	
61 to 100	1	H60100-1	—	—	—	—	—	CR	7	CR #1/0-8 Cu/Al
	2	H60100-2	—	—	—	—	—	CR	8	
	3	H60100-3	—	—	—	—	—	CR	9	

Class H(K) and R Fuse Blocks – 600V

Class R Fuseblocks (600V) Catalog Data (for LPS-RK, FRS-R, PVS-R and KTS-R Fuses)

Amps	Poles	Catalog Number	Terminal Type (Suffix No.)				Fig. No.	Wire Range
			Screw w/		Box Lug w/			
			—	Pres. Plate	—	Clip Cu Only		
1/2 to 30	1	R60030-1	SR	PR	CR	—	1	COR #6-14 Cu Only
	2	R60030-2	SR	PR	CR	COR	2	CR #2-14 Cu, #2-12 Al
	3	R60030-3	SR	PR	CR	COR	3	PR, SR #10-18 Cu Only
31 to 60	1	R60060-1	—	—	CR	—	4	CR #2-14 Cu, #2-8 Al
	2	R60060-2	—	—	CR	—	5	
	3	R60060-3	—	—	CR	—	6	
61 to 100	1	R60100-1	—	—	CR	—	7	CR, 1/0-8 Cu/Al
	2	R60100-2	—	—	CR	—	8	
	3	R60100-3	—	—	CR	—	9	

Dimensionals – in

600V, 1/2 to 30A

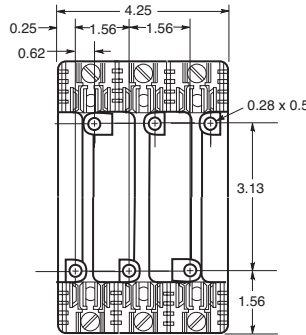
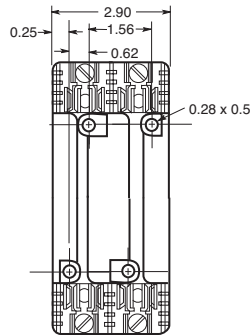
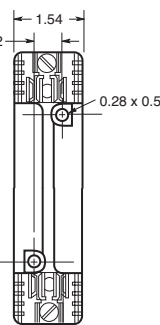
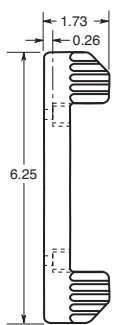

FIGURE 1.

FIGURE 2.

FIGURE 3.

600V, 31 to 60A

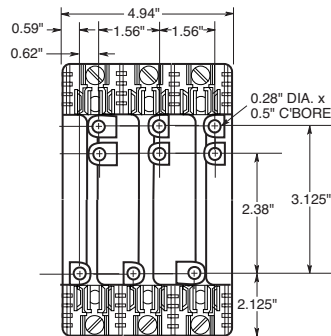
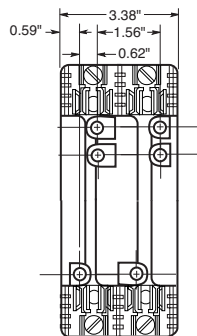
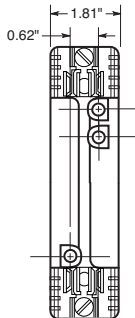
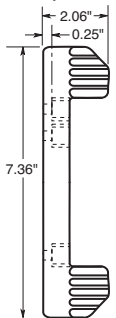

FIGURE 4.

FIGURE 5.

FIGURE 6.

600V, 61 to 100A

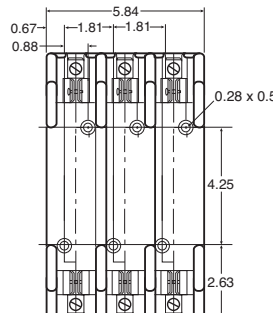
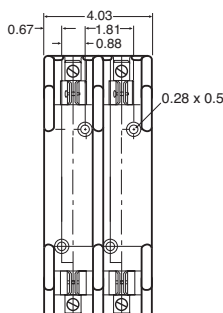
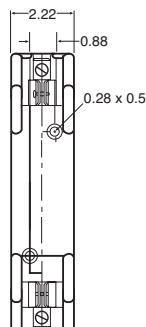
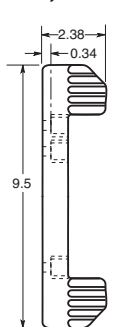

FIGURE 7.

FIGURE 8.

FIGURE 9.

Data Sheet: H600 Series, 1113; R600 Series, 1111

Class J Fuse Blocks

J600 Series

Specifications

Description: 1-, 2- or 3-pole fuse blocks for use with Class J fuses (Bussmann LPJ, DFJ and JKS).

Dimensions: See Dimensions illustrations.

Construction: Thermoplastic.

Poles: 1 to 3

Ratings:

Volts — 600Vac/dc

Amps — ½-100A

SCCR: — 200kA RMS Sym.

Agency Information: CE, UL Listed, UL 4248, Guide IZLT, File E14853, CSA Certified, C22.2 No. 4248, Class 6225-01, File 47235.

Flammability Rating: UL 94V0.

Mounting: Accepts DIN-Rail adapter DRA-1. See page 507.

Catalog Numbers



Features and Benefits

- J600 fuse blocks provide one-, two- and three-pole housing for Class J fuses at 600Vac.
- J600 fuse blocks are listed with a Short-Circuit Current Rating of 200kA RMS Sym.

Typical Applications

- 600Vac/dc or less Control Systems
- 600Vac/dc or less Industrial Control
- 600Vac/dc or less Individual Control Circuits

Catalog Numbers							
Screw†	Pressure Plate†	Box Lug	Box Lug w/ Retaining Clip	Amps	Poles	Fig. No.	Wire Range
J60030-1S*	J60030-1P	J60030-1C	J60030-1CR††	½-30	1	1	C, CR #2-14 Cu, #2-8 Al
J60030-2S*	J60030-2P	J60030-2C	J60030-2CR††		2	2	COR #2-14 Cu Only
J60030-3S*	J60030-3P	J60030-3C	J60030-3CR††		3	3	P, PR, S, SR #10-14 Cu Only
—	—	J60060-1C	J60060-1CR††	31-60	1	1	C, CR, #2-14 Cu/Al COR #4-14 Cu Only
—	—	J60060-2C	J60060-2CR††		2	2	
—	—	J60060-3C	J60060-3CR††		3	3	
—	—	—	J60100-1CR	61-100	1	4	COR 1/0-8 Cu Only
—	—	—	J60100-3CR††		3	5	CR, CRQ 1/0-8 Cu/Al

†Clip reinforcing springs are standard on fuse blocks rated 100A and above. Available on 30A and 60A blocks by adding the letter "R" to the end of the part number.

††Copper only connections available by changing "CR" suffix to "COR".

*No UL, No CSA Certification

Dimensions - in (±0.015)

½ - 60A

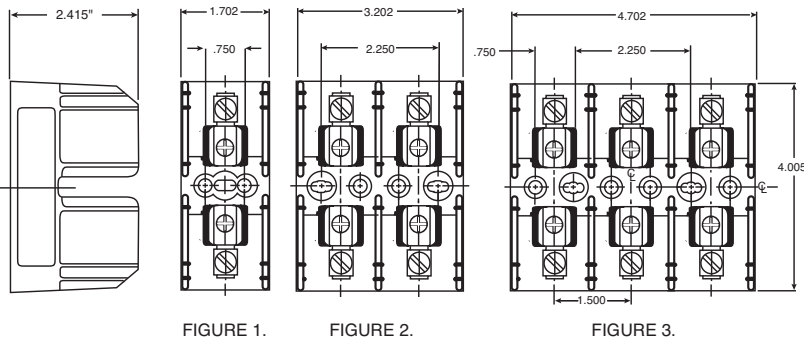

61-100A

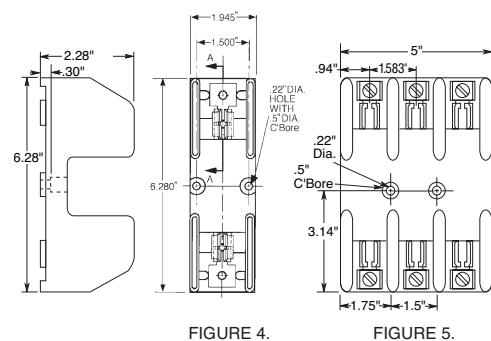

Class J Fuse Blocks

JP Series

Specifications

Description: Pyramid style 3-pole fuse block for use with Class J fuses (Bussmann LPJ, DFJ, JKS).

Dimensions: See Dimensions illustrations.

Ratings:

Volts: — 600Vac/dc

Amps: — 0-30A

SCCR: — 200kA RMS Sym.

Agency Information: CE, UL Listed, UL 4248, Guide IZLT, File E14853, CSA Certified, C22.2 No. 39, Class 4225-04, File 47235.

Flammability Rating: UL 94V0.

Mounting: Panel or 35mm DIN-Rail mount.

To order DIN-Rail: Part# NDNA 100 (1 meter) or NDNA 200 (2 meter).

Catalog Numbers

Catalog Numbers	Panel	With DIN Rail Adapter*	Mounting Screws with Pressure Plate	Box		
				Aluminum	Copper Only	Wire Range
JP60030-3PR	X		X			#10-14 Cu Only
JP60030-3CR	X			X		#2-14 Cu/Al
JP60030-3COR	X				X	#2-14 Cu Only
JP60030-3PRA		X	X			#10-14 Cu Only
JP60030-3CRA		X		X		#2-14 Cu/Al
JP60030-3CORA		X			X	#2-14 Cu Only

*Adapter only for DIN-Rail - Cat No. JPA-3.



Dimensions - in ± 0.015" (± 0.40mm)

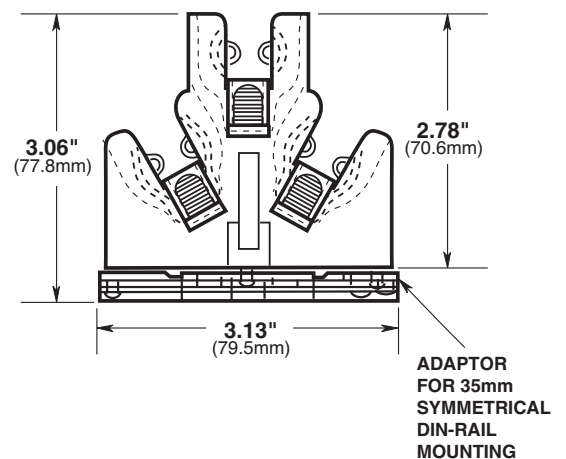
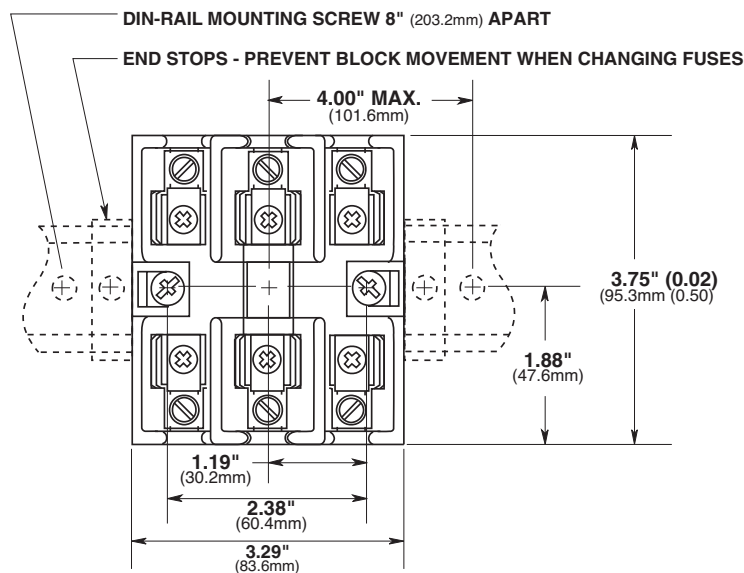

Class T Fuse Blocks – 300V

T300

Specifications

Description: T300 (300V) fuse blocks for use with Class T fuses (Bussmann JLN).

Dimensions: See Dimensions illustrations.

Poles: 1 to 4

Ratings:

Volts: — 300Vac/dc

Amps: — ½ - 600A

SCCR: — 200kA RMS Sym.

Agency Information: CE, UL Listed UL 4248, Guide IZLT, File E14853, CSA Certified, Class 6225-01, File 47235.

Flammability Rating: UL 94V0.

Features and Benefits

- Provide 1-, 2- and 3-pole housing for 300Vac Class T fuses.
- Short-Circuit Current Rating of 200kA RMS Sym.
- Class T fuse blocks have a small foot print, providing substantial space savings in equipment

Typical Applications

- 300Vac/dc or less Control Systems
- 300Vac/dc or less Individual Control Circuits



T30100-1CR



T30030-2CR



T30600-1C

Catalog Numbers

Catalog Numbers					
Screw	Box Lug	Amps	Poles	Fig. No.	Wire Range
T30030-2SR	T30030-2CR	½-30	2	1	SR #10-18 Cu CR #6-14 Cu/Al
T30030-3SR	T30030-3CR		3		
T30030-4SR	T30030-4CR		4		
T30060-2SR	T30060-2CR	31-60	2	1	CR #2-14 Cu/Al SR #10-18 Cu Only
T30060-3SR	T30060-3CR		3		
T30060-4SR	T30060-4CR		4		
—	T30100-1CR	61-100	1	2	1/0-8 Cu/Al
—	T30100-2CR		2		
—	T30100-3CR		3		
—	T30200-1C	101-200	1	3	250kcmil-6 Cu/Al
—	T30200-3C		3	4	
—	T30400-1C	201-400	1	5	600kcmil-2/0 Cu/Al
—	T30600-1C	401-600	1	6	(2) 600kcmil-4/0 Cu/Al

Dimensions - in Figure 1. ½-60A

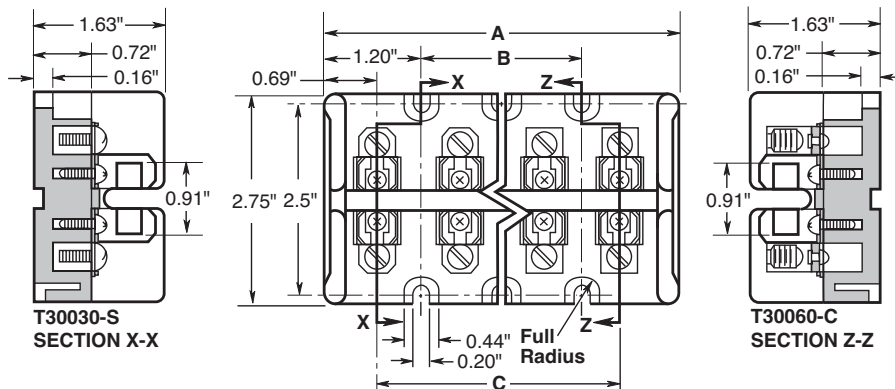

Catalog Number	Dimensions - in		
	A	B	C
T30030-2	2.41	—	1.03
T30060-2	2.41	—	1.03
T30030-3	3.44	1.03	2.06
T30060-3	3.44	1.03	2.06
T30030-4	4.47	2.06	3.09
T30060-4	4.47	2.06	3.09

Class T Fuse Blocks – 300V

Figure 2. 61 to 100A

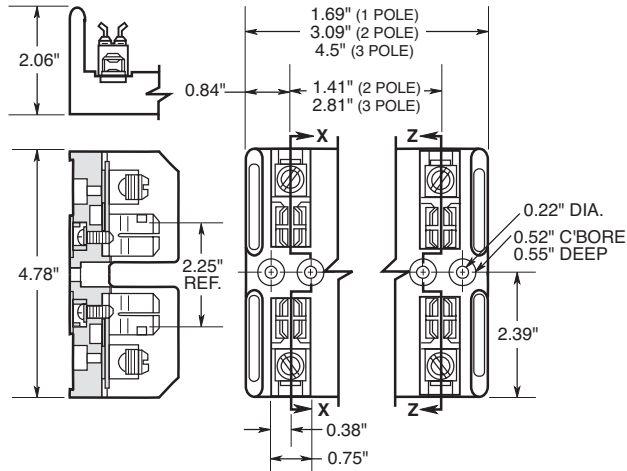

Figure 3. 101 to 200A

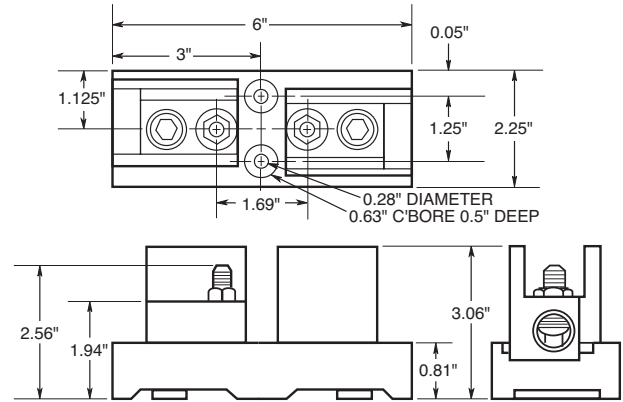

Figure 4. 200A

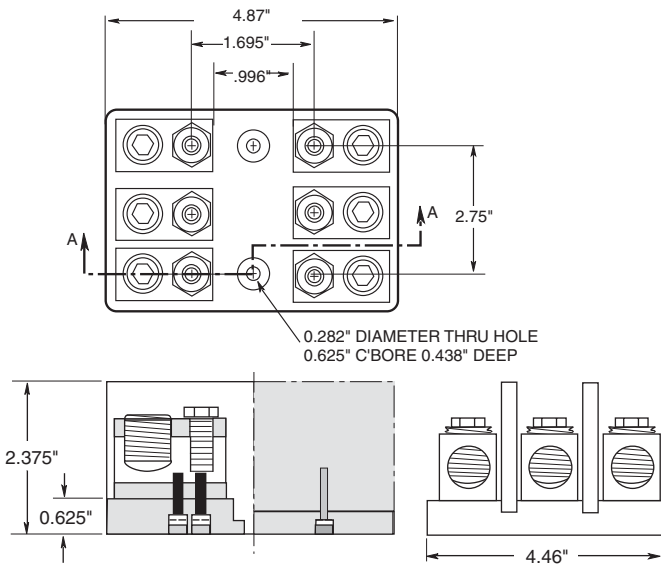

Figure 5. 201 to 400A

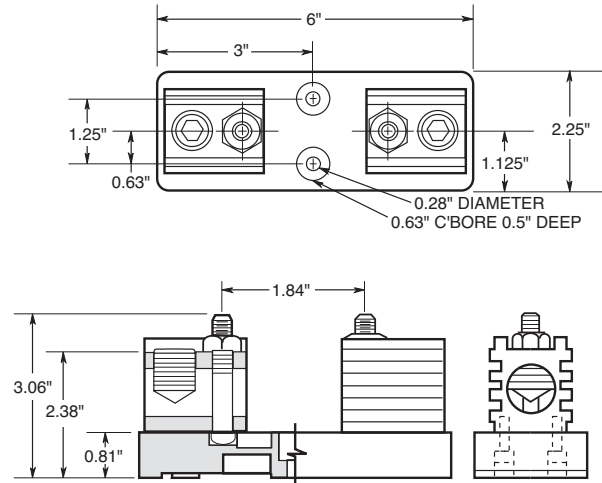
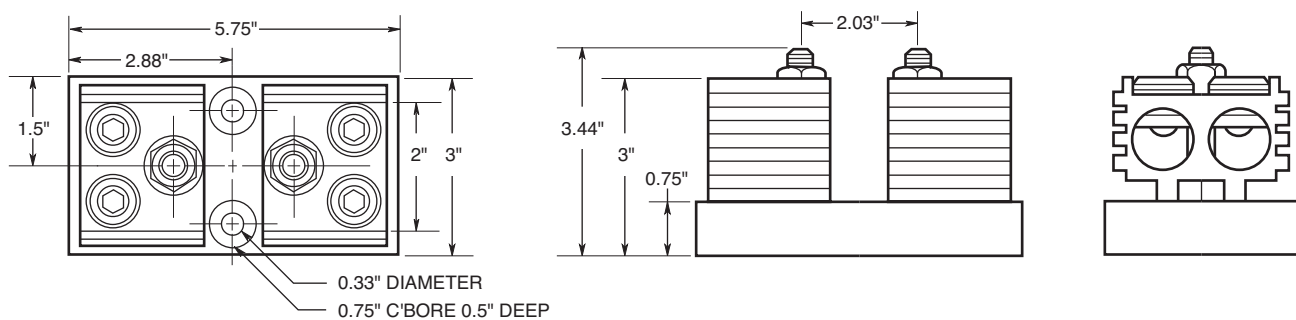

Figure 6. 401 to 600A



Data Sheet: 1115

Class T Fuse Blocks – 600V

T600

Specifications

Description: T600 (600V) fuse blocks for use with Class T fuses (Bussmann JJS).

Dimensions: See Dimensions illustrations.

Poles: 1 to 3

Ratings:

Volts: – 600Vac/dc

Amps: – ½ - 600A

SCCR: – 200kA RMS Sym.

Agency Information: CE, UL Listed UL 4248, Guide IZLT, File E14853, CSA Certified, Class 6225-01, File 47235.

Flammability Rating: UL 94V0.

Features and Benefits

- Provide 1-, 2- and 3-pole housing for 600Vac Class T fuses.
- Short-Circuit Current Rating of 200kA RMS Sym.
- Class T fuse blocks have a small foot print, providing substantial space savings in equipment

Typical Applications

- 600Vac/dc or less Control Systems
- 600Vac/dc or less Individual Control Circuits



T60600-1C

T30030-2CR

Catalog Numbers

Screw	Box Lug	Amps	Fig.	Poles	No.	Wire Range
T60030-1SR	T60030-1CR	½-30	1	1	1	SR #10-18 Cu CR #2-14 Cu/Al
T60030-2SR	T60030-2CR		2			
T60030-3SR	T60030-3CR		3			
T60060-1SR	T60060-1CR	31-60	1	2	2	CR #2-14 Cu/Al SR #10-18 Cu Only
T60060-2SR	T60060-2CR		2			
T60060-3SR	T60060-3CR		3			
—	T60100-1C	61-100	1	3	3	2/0-14 Cu/Al
—	T60100-2C		2			
—	T60100-3C		3			
—	T60200-1C	101-200	1	4	4	250kcmil-6 Cu/Al
—	1B0089*		3			
—	T60400-1C	201-400	1	5	5	600kcmil-2/0 Cu/Al
—	T60600-1C	401-600	1	6	6	(2) 600kcmil-4/0 Cu/Al

* UL Listed, Guide IZLT, File E14853, CSA Certified Class 6225-01, File 21455M18

Dimensions - in

Figure 1. ½ to 30A

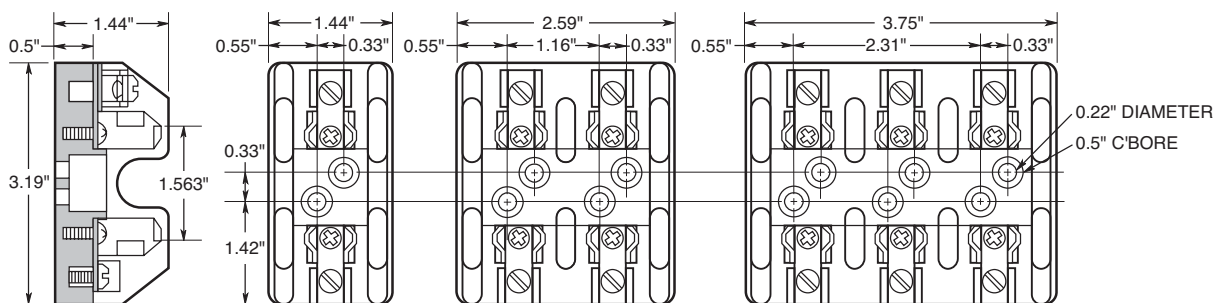
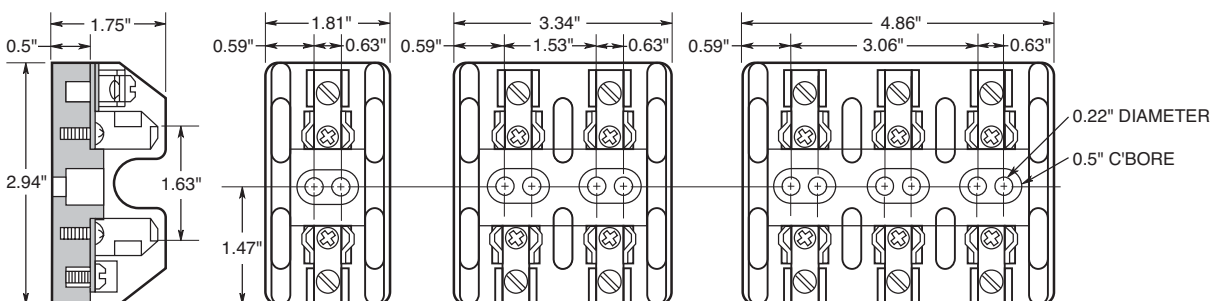

Figure 2. 31 to 60A



Data Sheet: 1116

Class T Fuse Blocks – 600V

Figure 3. 61 to 100A

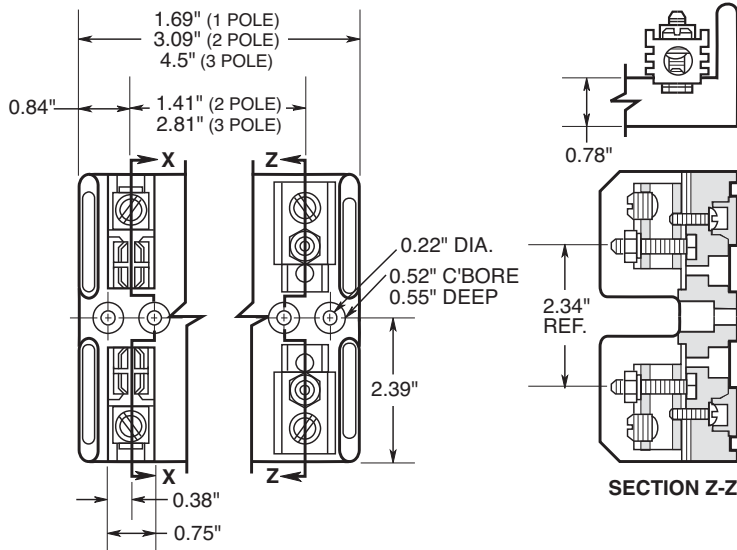

Figure 4. 101 to 200A

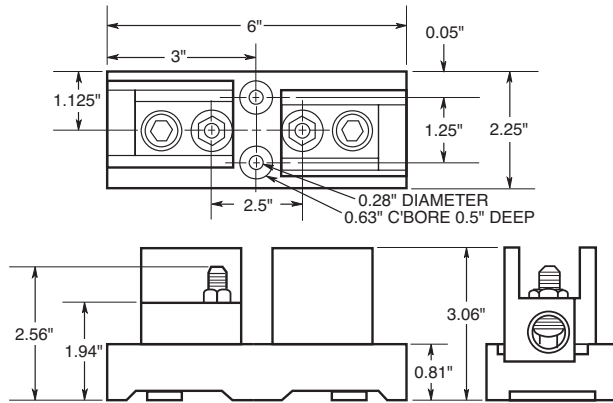

Figure 5. 201 to 400A

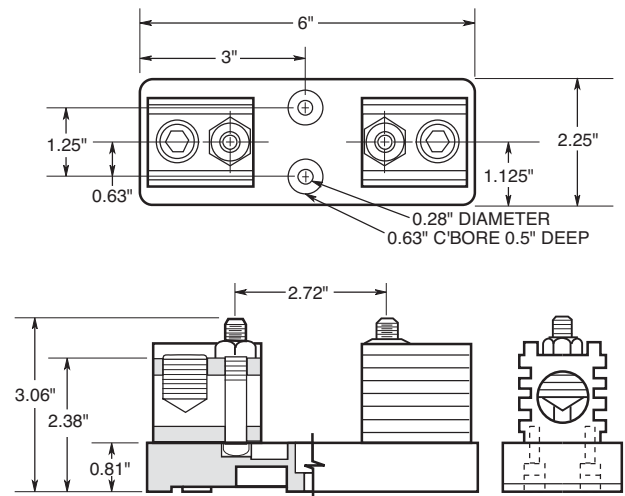
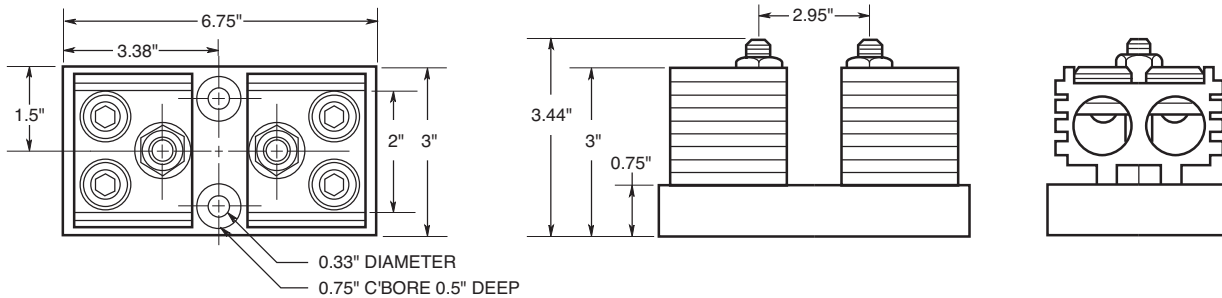

Figure 6. 401 to 600A



Add-a-pole Fuse Blocks

BCA Series - Class CC fuses BMA Series - 1 3/32" X 1 1/2" fuses

Specifications

Description: 1-, 2 and 3-pole fuse blocks for use with Class CC fuses (BCA Series use Bussmann LP-CC, KTK-R, and FNQ-R), or with standard 1 3/32" x 1 1/2" fuses (BMA Series use Bussmann KTK, FNQ, PVN, FNM, BAF, PV and AGU) Both Series use an "adder block" to form multi-pole segmented blocks to achieve the desired number of poles.

Dimensions: See Dimensions illustration.

Poles: 1 to 3.

Wire Range: #10-#18 Cu only.

Terminals: Screw/quick connect* or pressure plate/quick connect*.

Ratings:

Volts: — 600Vac/dc

Amps: — 1/0-30A

SCCR: — BCA Series:
200kA RMS Sym.
BMA Series:
10kA RMS Sym.

Agency Information:

BCA Series: CE, UL Listed, UL 4248, Guide IZLT, File E14853. CSA Certified, C22.2 No. 4248, Class 6225-01, File 47235.
BMA Series: CE, UL Recognized, UL 4248, Guide IZLT2, File E14853. CSA Certified, C22.2 No. 4248, Class 6225-01, File 47235.

Flammability Rating: UL 94V0

*Quick connect rated for 20A maximum.

Catalog Numbers

BCA Series Catalog Numbers	Poles	Terminal Type
BCA603ASQ	Adder Block	Screw w/ quick connect
BCA6031SQ	1	Screw w/ quick connect
BCA6032SQ	2	Screw w/ quick connect
BCA6033SQ	3	Screw w/ quick connect
BCA603APQ	Adder Block	Pressure plate w/ quick connect
BCA6031PQ	1	Pressure plate w/ quick connect
BCA6032PQ	2	Pressure plate w/ quick connect
BCA6033PQ	3	Pressure plate w/ quick connect

Dimensions in ± 0.015" (0.38mm)

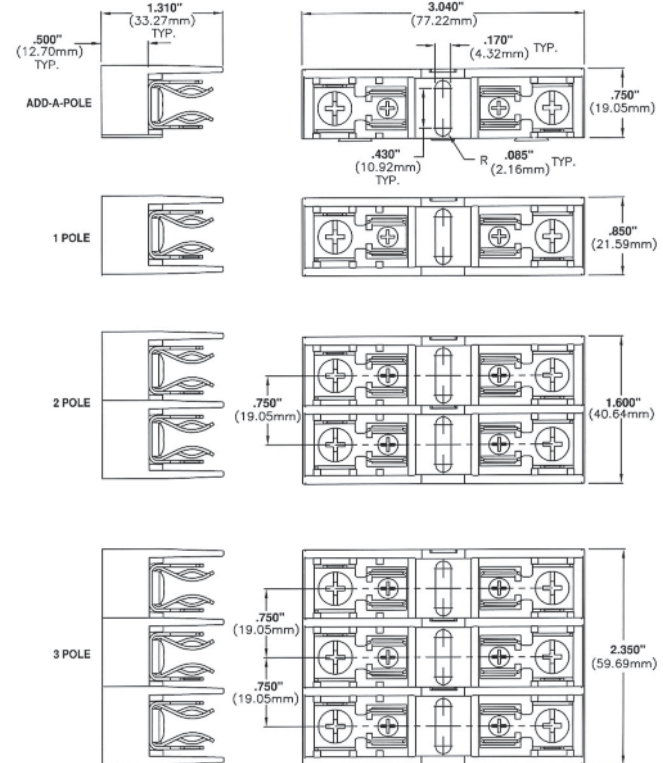

BMA Series

BMA Series Catalog Numbers	Poles	Terminal Type
BMA603ASQ	Adder Block	Screw w/ quick connect
BMA6031SQ	1	Screw w/ quick connect
BMA6032SQ	2	Screw w/ quick connect
BMA6033SQ	3	Screw w/ quick connect
BMA603APQ	Adder Block	Pressure plate w/ quick connect
BMA6031PQ	1	Pressure plate w/ quick connect
BMA6032PQ	2	Pressure plate w/ quick connect
BMA6033PQ	3	Pressure plate w/ quick connect

Class CC, Type M and Class G Fuse Blocks

BC Series



Specifications

Description: Class CC fuse blocks for use with Class CC fuses (Bussmann LP-CC, KTK-R, and FNQ-R).

Dimensions: See Data Sheet 1105

Poles: 1 to 3

Ratings:

Volts: — 600V
Amps: — 1/0-30A
SCCR:— 200kA RMS Sym.

Agency Information: CE, UL Listed (Guide IZLT, File E14853), CSA (Class 6225-01, File 47235)

Flammability Rating: UL 94V0

DIN-Rail Adapters: See page 413 for DRA-1 & DRA-2

Catalog Numbers

Screw	Terminal Type				Poles
	Screw with Quick Connect*	Pressure Plate	Pressure Plate w/ Quick Connect*	Box Lug	
BC6031S	BC6031SQ	BC6031P	BC6031PQ	BC6031B	1
BC6032S	BC6032SQ	BC6032P	BC6032PQ	BC6032B	2
BC6033S	BC6033SQ	BC6033P	BC6033PQ	BC6033B	3

Data Sheet: 1105

BCCM Series

Description: 3-pole fuse block for use with (2) Class CC fuses and (1) 1/2" x 1 1/2" fuse

Catalog Numbers

Catalog Numbers	Terminal Type
BCCM6033SQ	Screw with Quick-Connect*
BCCM6033PQ	Pressure Plate w/Quick-Connect*

*Quick-connect terminal rated for 20A max.

Recommended Cover Puller

- PF1-WH (White)
- PF1-BK (Black)

BM Series Type M



Specifications

Description: Supplementary fuse blocks for use with any 1/2" x 1 1/2" fuses (Bussmann KTK, PVM, FNQ, FNM, BAF, PV, and AGU).

Dimensions: See Data Sheet 1104

Poles: 1 to 3

DIN-Rail Adapters: See page 413 for DRA-1 & DRA-2

Ratings:

Volts: — 600Vac/dc
Amps: — 1/0-30A
SCCR:— 10kA RMS Sym.

Agency Information: CE, UL Recognized (Guide IZLT2, File E14853), CSA (Class 6225-01, File 47235).

Flammability Rating: UL 94V0.

Catalog Numbers

Screw with Quick Connect*	Terminal Type			Poles
	Pressure Plate w/ Quick Connect*	Box Lug		
BM6031SQ	BM6031PQ	BM6031B		1
BM6032SQ	BM6032PQ	BM6032B		2
BM6033SQ	BM6033PQ	BM6033B		3

Recommended Cover Puller

- PF1-WH (White)
- PF1-BK (Black)

Data Sheet: 1104

BG & G Series



Specifications

Description: Class G fuse blocks for use with Class G fuses (Bussmann SC).

Dimensions: See Data Sheet 1106

Poles: 1 to 3

Ratings:

Volts: — 600Vac/dc (0-20A)
— 480Vac/dc (25-60A)
Amps: — 1-60A (See Catalog Numbers table)

SCCR: — 100kA RMS Sym.

Agency Information: CE, UL Listed 35-60A (Guide IZLT, File E14853), UL Recognized 1-30A, (Guide IZLT2, File E14853), CSA (Class 6225-01, File 47235).

DIN-Rail Adapters: See page 413 for DRA-1 & DRA-2.

Catalog Numbers

Screw with Quick Connect*	Terminal Type				Amps	Poles
	Pressure Plate w/ Quick Connect*	Box Lug	Box Lug w/retaining clip			
BG3011SQ	BG3011PQ	BG3011B	—	1-15	1	
BG3012SQ	BG3012PQ	BG3012B	—		2	
BG3013SQ	BG3013PQ	BG3013B	—		3	
BG3021SQ	BG3021PQ	BG3021B	—	20	1	
BG3022SQ	BG3022PQ	BG3022B	—		2	
BG3023SQ	BG3023PQ	BG3023B	—		3	
BG3031S	BG3031P	BG3031B	—	25-30	1	
BG3032S	BG3032P	BG3032B	—		2	
BG3033S	BG3033P	BG3033B	—		3	
—	—	—	G30060-1CR	35-60	1	
—	—	—	G30060-2CR		2	
—	—	G30060-3C	G30060-3CR		3	

Recommended Cover Puller

- PF1-WH (White)
- PF1-BK (Black)

Data Sheet: 1106

Modular Fuse Blocks

BH Series

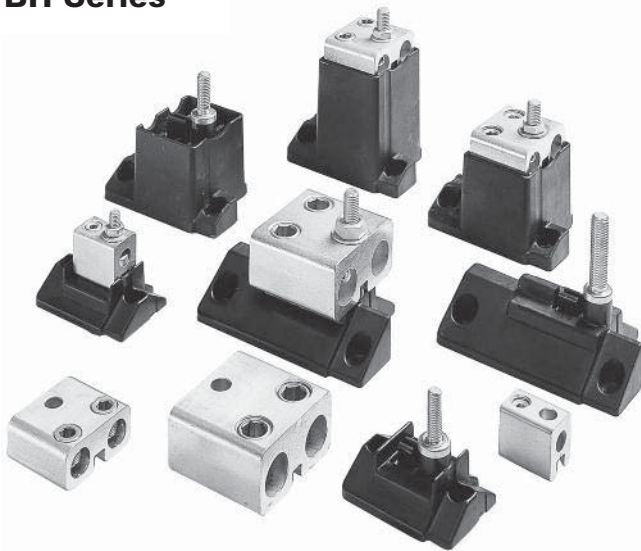

Specifications

Description: For use with Bussmann high speed fuses.

Ratings:

SCCR: — 200kA RMS Sym. or fuse IR, whichever is lower.

Agency Information: CE, UL Recognized, Guide EZLT2, File No. E14853 up to 700V, CSA Certified, Class 6225-01, File No. 47235 up to 700V.

BH Series Features and Benefits

- BH fuse blocks provide a wide range of mounting configurations for Bussmann high speed fuses.
- BH fuse blocks have a Short-Circuit Current Rating of any installed fuse up to 200kA RMS Sym.

Typical Applications

- Solid State Control Circuits
- VFDs
- UPS Systems

Catalog Numbers

BH-0001	BH-0122	BH-2001	BH-3004
BH-0002	BH-1001	BH-2002	BH-3033
BH-0003	BH-1002	BH-2003	BH-3144
BH-0111	BH-1003	BH-2031	BH-3145
BH-0112	BH-1131	BH-2032	
BH-0113	BH-1132	BH-2033	
BH-0121	BH-1133	BH-3003	

Refer to the data sheet numbers below for the catalog code description information.

Data Sheet: (BH-0) 1200; (BH-1) 1201; (BH-2) 1202; (BH-3) 1203

Modular Type Fuse blocks for Class H & J Fuses



Specifications

Description: 3-Pole only, modular type fuse blocks for Class H & J fuses with standard reinforced retaining clips.

Ratings:

- Volts: — 250V (0-60A See Catalog Numbers table)
 — 600V (35-60A See Catalog Numbers table)
- Amps: — 0-60A @ 250Vac/dc (See Catalog Numbers table)
 — 35-60A@600V (See Catalog Numbers table)
- SCCR: — Class J 200kA, Class H 10kA

Agency Information: CE, UL Recognized, Guide IZLT2, File E14853, CSA Certified, Class 6225-01, File 47235.

Class H & J Features and Benefits

- H & J modular fuse blocks provide three pole 30 and 60 amp ratings for specific client requirements for separate line and load fuse clip configurations.

Typical Applications

- Up to 60A, space confined, control circuits

Catalog Numbers					
Screw	Pressure Plate	Fuse Class	Volts	Amps	Fig. No.
11241-3SR*	11241-3PR*	H	250	60	1
11242-3SR	11242-3PR				2
11241-3SR	11241-3PR		600	35	1
11242-3SR**	11242-3PR**				2
11239-3SR	11239-3PR	J	600	60	1
11240-3SR**	11240-3PR**				2
11241-3SR	11241-3PR		60	35	1
11239-3SR*	11239-3PR*				60

Note: Order two blocks per fuse (matched or mixed).
 *11239 and 11241 have wire terminals and mounting holes located under fuse. (Figure 1)
 **11240 and 11242 have wire terminals and mounting holes located at end of fuse. (Figure 2)

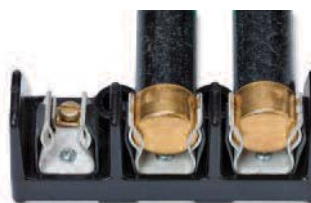

Figure 1



Figure 2

Box Cover Units for Plug Fuses

SOU, SRU, SSN, SSU, SOW, SRW, SSW, SOX, SRX, SSX, SOY, SRY, SSY, SSY-RL, SSY-L, STY, SCY & SOY-B

Specifications

Description: Box covers for standard electrical boxes that provide fused outlet, fused switch or circuit fuse protection.

Ratings:

Volts: — 125V/250V (See Catalog Numbers table)

Amps: — 0-15A (See Catalog Numbers table)

Agency Information: CE, See Catalog Numbers table.

Features/Benefits

- Bussmann Box Cover Units provide a low-cost method of controlling and protecting small motors when used with Bussmann Type T, Fusetron™, dual-element fuses.
- Provide low-cost supplementary protection and disconnection of 125V or less, single phase circuits.

Typical Applications

- Fractional Horsepower, 125 Volt Single-Phase Motor Circuits
- General 125 Volt Supplemental Circuits

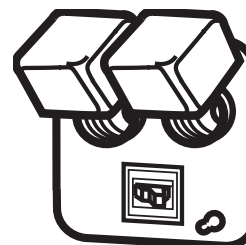

STY



SSN

Catalog Numbers

Catalog Numbers	Type Box	Fuse holder ³		Receptacle Outlet to Load		Switch Control ¹	Switch Light ²	Motor Size (Max)	General Data	Agency ⁴ Listing/Certification	
		Single	Double	125V	250V						
SOU	2 1/4" Handy	X						1/4hp	125V, 15A	UL, CSA	
SRU		X		X				1/2hp	125V, 15A	UL	
SSU		X				X			1/2hp	125Vac, (do not use on dc), 15A	UL, CSA
SOW	2 3/4" Switch	X						1/4hp	125V, 15A	UL, CSA	
SRW		X		X				1/2hp	125V, 15A	UL	
SSW		X				X			1/2HP	125Vac, (do not use on dc), 15A	UL, CSA
SOX	4" Octagon	X						1/4hp	125V, 15A	UL, CSA	
SRX		X		X				1/2hp	125V, 15A	UL	
SSX		X				X			1/2hp	125Vac, (do not use on dc), 15A	UL, CSA
SOY	4" Square	X						1/4hp	125V, 15A	UL, CSA	
SRY		X		X				1/2hp	125V, 15A	UL	
SSY		X				X			1/2hp	125Vac, (do not use on dc), 15A	UL, CSA
SSY-RL		X		X		X	X		1/2hp	125Vac, (do not use on dc), 15A	—
STY ³			X				X		1/2hp	125Vac, (do not use on dc), 15A	UL
SCY				X			X(2)		1/2hp (2)	125Vac, (do not use on dc), can protect two motors, 15A	UL
SOY-B			X					1/4hp	125V, protects two motors, 15A	UL	
SSN	Single Gang	X		X		X		1/2hp	Weatherproof model, 15A	UL	

1 Switch turns power to fused load OFF or ON.

2 Switch light indicates power to load (dark when switch OFF or fuse open).

3 Double pole switch opens both sides of circuit. Can be used for two separate motors with common switch or a single motor (1/4Hp, 250Vac max.).

4 UL Guide JAMZ, File IE6491; CSA Class 6225-01, File 47235.

In-line Fuse Holders for 1/4" x 7/8" to 1 1/4" Fuses

HFB & HFB-10



Specifications

Description: Water-resistant in-line fuse holder for 1/4" x 1 1/4" fuses.

Dimensions: See Dimensions illustration.

Construction: Thermoplastic rubber body with tin-plated, copper contacts.

Ratings:

Volts: — 32V

Amps: — 30A max

Catalog Numbers

Catalog Numbers	Description
HFB*	Standard Pack (10-in)
BK/HFB	Bulk Pack (100-in)
BK/1A2294	HFB Replacement Contact Clip
1A2294-01	HFB-10** Replacement Contact Clip

*HFB accepts #12 to #18 wire leads (not provided). See Data Sheet for recommended crimp tools.
**HFB-10 accepts #10 wire leads (not provided). See Data Sheet for recommended crimp tools.

Features/Benefits

- Simple assembly with one-piece thermoplastic (important information molded into body)
- High visibility yellow color for easy identification in dark or hard-to-access locations
- Ideal for shock and vibration environments; withstands many organic solvents; temperature range - 40/+150°C

Typical Applications

- Supplemental, Low Voltage, Low Amperage Control Circuits

Dimensions - in (mm)

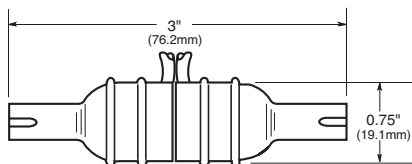

Data Sheet: 2102

HHB



Specifications

Description: Universal in-line fuse holder for 1/4" x 7/8", 1" and 1 1/4" fuses.

Dimensions: See Dimensions illustration.

Construction: Nylon body with tin-plated, copper contacts.

Ratings:

Volts: — 32V

Amps: — 30A max

Flammability Rating: UL 94V2.

Pull Force: 5lbs minimum to separate fuse holder housing with fuse installed.

Features and Benefits

- HHB Universal in-line fuse holder for 1/4" x 7/8", 1" and 1 1/4" fuses.

Typical Applications

- Supplemental, Low Voltage, Low Amperage Control Circuits

Catalog Numbers

Holder — without leads* - RoHS compliant

Catalog Numbers	Description
HHB-R	Standard Pack (10-in)
BK/HHB-R	Bulk Pack (100-in)

*Accepts #12 to #16 wire leads (not provided with basic fuse holder). See Data Sheet for recommended crimp tools.

Holder — with pre-attached #14 Insulated lead wires - Not RoHS compliant unless noted

Catalog Numbers	19" Length	8" Length	Wire Color
BK/HHB-Y419	BK/HHB-Y408		Yellow
BK/HHB-R419	BK/HHB-R408**		Red
BK/HHB-B419	BK/HHB-B408		Black

**RoHS compliant.

Dimensions - in (mm)

Fuse Length	Fuse Holder Length "L"
7/8" (AGW)	2.100 Max
1" (AGX)	2.250 Max
1 1/4" (AGC, MDL)	2.420 Max

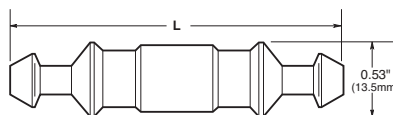

Data Sheet: 2103

HRK



Specifications

Description: Universal in-line fuse holder for 1/4" x 7/8" to 1 1/4" fuses.

Dimensions: See Dimensions illustration.

Construction: 8" (203mm) #14 lead wires.

Ratings:

Volts: — 32V

Amps: — 15A max

Features and Benefits

- HRK Universal in-line fuse holder for 1/4" x 7/8", 1" and 1 1/4" fuses with #14 lead wires.
- RoHS compliant

Typical Applications

- Supplemental, Low Voltage, Low Amperage Control Circuits

Catalog Number

Catalog Number	Amp Rating	Fuse Description
HRK-R*	15 32	1/4" diameter fuses of different lengths.

*Three springs furnished with fuse holder to accommodate different length 1/4" fuses.

Dimensions - in (mm)

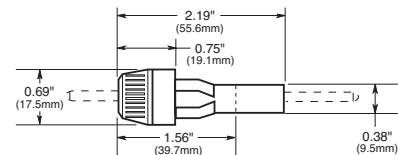

Data Sheet: 2111

In-line Fuse Holders

HR and HM Series

Specifications

Description: In-line fuse holders for SFE and 1/4" dia. x various length fuses.

Dimensions: See Dimensions illustration.

Ratings:

Volts: — 32V
Amps: — 20A

Features and Benefits

- HR and HM Universal in-line fuse holder for SFE and various length 1/4" diameter fuses with #14 lead wires.

Typical Applications

- Supplemental, Low Voltage, Low Amperage Control Circuits

Catalog Numbers

Catalog Numbers	Includes Fuse	Wire Length & Size
HRJ*	SFE-20	19" of #14
HRI	SFE-14	
HRH	SFE-9	
HRE	SFE-7½	
HRG	SFE-6	
HRF	SFE-4	
HMJ**	SFE-20	8" of #14
HMI	SFE-14	
HMH	SFE-9	
HME	SFE-7½	
HMG	SFE-6	
HMF	SFE-4	

* Also available as in-line fuse holder only with lead wire contacts, HRJ-LESS-Fuse.

** Also available as in-line fuse holder only with lead wire contacts, HMJ-LESS-Fuse.

HHJ-A For 1/4" x 1 1/4" fuse, no wire or fuse included, accepts #18 - #22 wire.

HHJ-B For 1/4" x 1 1/4" fuse, no wire or fuse included, accepts #12 - #16 wire.

HHI-B For 1/4" x 1 1/8" fuse, no wire or fuse included, accepts #12 - #16 wire.

Replacement Contacts

Catalog Number	Symbol
9838	HHJ-A
9841	HHJ-B

Dimensions - in (mm)

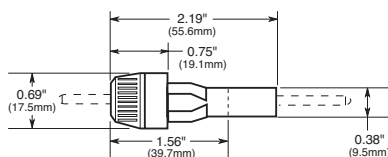

Data Sheet: 2122

HFA Series



Specifications

Description: In-line water-resistant fuse holders for 1/4" x 1 1/4" fuses.

Dimensions: See Dimensions illustration.

Ratings:

Volts: — 250V
Amps: — 20A

Refer to data sheet for recommend crimp tools

Catalog Numbers

Catalog Numbers	Terminals
HFA	Crimp #12 - #16
HFA-HH*	1/4" Quick Connect

*No UL Recognition.

Data Sheet: 2115

HEG Series



Specifications

Description: Single-pole, non-breakaway, in-line fuse holders for Type SC fuses, 480V (or less).

Ratings:

Volts: — 600V
Amps: — 0-15A

Fuse Size: 1 3/32" x 1.31"

Catalog Number

HEG-AA

Optional Boots:

2A0660 Single Conductor
2A0661 Two Conductor

Data Sheet: 2124

HHT Series



Specifications

Description: In-line fuse holders for 5 x 15mm or 5 x 20mm fuses.

Dimensions: See Dimensions illustration.

Construction: Black thermoplastic body with brass contacts, wire: 16 AWG, red.

Ratings:

Volts: — 32V
Amps: — 5A (5 x 15mm)
— 10A (5 x 20mm)

Catalog Numbers

Catalog Number	Fuse Size
HHT	5 x 15mm & 5 x 20mm

Data Sheet: 2138

HEH Series



Specifications

Description: Single-pole, non-breakaway, in-line fuse holders for Type SC fuses (Also fuse types BBS & KTQ, nominal size 1 3/32" x 1 3/8").

Ratings:

Volts: — 600V
Amps: — 0-20A

Agency Information: CSA - 15A.

Catalog Numbers

HEH-AA, HEH-AD

Optional Boots:

2A0660 Single Conductor
2A0661 Two Conductor

Data Sheet: 2124

Tron™ In-line Fuse Holders

HEC Series



Specifications

Description: Single-pole, non-breakaway, in-line fuse holders for Type SC-25, & SC-30 fuses, size 1 1/2" x 1 5/8".

Ratings:

Volts: — 480V
Amps: — 0-30A

Catalog Numbers

HEC-AA, HEC-RW-RLB-R

Optional Boots:

2A0660 Single Conductor
2A0661 Two Conductor

Data Sheet: 2124

HEJ Series



Specifications

Description: Single-pole, non-breakaway, in-line fuse holders for Type SC and Type HVW fuses, size 1 1/2" x 2 1/4".

Ratings:

Volts: — 480V
Amps: — 35-60A Type SC
— 1/2-6A Type HVW

Catalog Numbers

HEJ-AA, HEJ-AB, HEJ-AC, HEJ-BB, HEJ-JJ, HEJ-JK, HEJ-LL, HEJ-LLB, HEJ-CC, HEJ-DD, HEJ-WW, HEJ-PP, HEJ-QQ

Optional Boots:

2A0660 Single Conductor
2A0661 Two Conductor

Data Sheet: 2123

HEB Series



Specifications

Description: Single-pole in-line fuse holders for any 1 1/2" x 1 1/2" fuses (typically fuse types: BAF, FNM, FNQ, and KTK 1/0 - 30A).

Ratings:

Volts: — 600V
Amps: — 0-30A

Catalog Numbers

See Page 311

Optional Boots:

2A0660 Single Conductor
2A0661 Two Conductor

Data Sheet: 2127

HEX Series



Specifications

Description: Double-pole in-line fuse holders for 1 1/2" x 1 1/2" fuses (typically fuse types BAF, FNM, FNQ, and KTK 1/0 - 30A).

Ratings:

Volts: — 600V
Amps: — 0-30A

Catalog Numbers

HEX-AA, HEX-AB, HEX-AC, HEX-AD, HEX-AE, HEX-AW, HEX-AW-DRLC-A, HEX-AW-DRYC, HEX-AW-RLC-A, HEX-AW-RYC, HEX-AY, HEX-BB, HEX-CC, HEX-JJ, HEX-JK, HEX-JW-DRYC, HEX-KK

Data Sheet: 2126

HEZ Series



Specifications

Description: Waterproof (IPX7), single-pole Class CC in-line fuse holders. Holds Bussmann fuse types: LP-CC, FNQ-R and KTK-R.

Ratings:

Volts: — 600V (or less)
Amps: — Up to 30A*

Conductors: Lineside & Loadside**

#12 to #8 Crimp terminal
#12 to #3 Setscrew terminal

*Amp rating limited by conductor size and fuse sizing when used with insulating boots

**See details in non-breakaway and breakaway specifications

Data Sheet: 2130

HEY Series



Specifications

Description: Double-pole in-line fuse holders for KTK-R fuses with optional breakaway receptacle, polarized, and accepting Class CC branch circuit fuses (Bussmann KTK-R, FNQ-R & LP-CC; 600V or less, 200kA IR).

Ratings:

Volts: — 600V
Amps: — 0-30A

Catalog Numbers

HEY-AA, HEY-AB, HEY-AC, HEY-AD, HEY-AE, HEY-AL, HEY-AW-DRLC-A, HEY-AW-DRLC-B, HEY-AW-DRYC, HEY-BB, HEY-JJ

Data Sheet: 2126

HET Series



Specifications

Description: Single-pole in-line fuse holders for 1 1/2" x 1 1/2" fuses with a permanently solid neutral identified by white plastic coupling nut.

Catalog Numbers

HET-AA, HET-AB, HET-AW, HET-AW-RLC-A, HET-AW-RLC-B, HET-AW-RLC-C, HET-AW-RLC-J, HET-AW-RYC, HET-BB, HET-BW-RLC-B, HET-BW-RYC, HET-JJ, HET-JK, HET-JW, HET-JW-RLC-J, HET-JW-RYC, HET-KK

Data Sheet: 2125

For HEB Holders Only

Directions: To select complete holder P/N, work from left to right starting with loadside terminal options and then lineside terminal options. Then determine breakaway or non-breakaway style.

Loadside Terminal					Lineside Terminal					Available P/N's	
Terminal Type	Wire Size	No. of Wires per Terminal	Solid Wire	Stranded Wire	Terminal Type	Wire Size	No. of Wires per Terminal	Solid Wire	Stranded Wire	Non-Breakaway P/N (Boots not included)	Breakaway P/N (Boots included)
Copper Crimp	#12 to #8 #12	1 2	Y Y	Y Y	Copper Crimp	#12 to #8 #12	1 2	Y Y	Y Y	HEB-AA ⁽¹⁾⁽²⁾ ₍₃₎	HEB-AW-RLC-A ⁽¹⁾⁽²⁾ ₍₃₎
Copper Crimp	#12 to #8 #12	1 2	Y Y	Y Y	Copper Crimp	#6 #10	1 2	Y Y	Y Y	HEB-AB ⁽²⁾	HEB-AW-RLC-B
Copper Crimp	#12 to #8 #12	1 2	Y Y	Y Y	Copper Crimp ⁽⁴⁾	#4 #8	1 2	N Y	Y Y	HEB-AC ⁽²⁾	HEB-AW-RLC-C ⁽⁴⁾
Copper Crimp	#12 to #8 #12	1 2	Y Y	Y Y	Copper Crimp	#2 #6	1 2	N Y	Y Y	HEB-AD ⁽²⁾	N/A
Copper Crimp	#12 to #8 #12	1 2	Y Y	Y Y	Copper Crimp	2/0 #3	1 2	N N	Y Y	HEB-AE ⁽²⁾	N/A
Copper Crimp	#12 to #8 #12	1 2	Y Y	Y Y	Copper Setscrew	#12 to #3	1	Y	Y	HEB-AJ	HEB-AW-RLC-J
Copper Crimp	#12 to #8 #12	1 2	Y Y	Y Y	Copper Setscrew	#12 to #3	2	Y	Y	HEB-AK	HEB-AW-RYC
Copper Crimp	#12 to #8 #12	1 2	Y Y	Y Y	Aluminum Setscrew	#12 to #2	1	Y	Y	HEB-AL	HEB-AW-RLA
Copper Crimp	#12 to #8 #12	1 2	Y Y	Y Y	Aluminum Setscrew	#12 to #2	2	Y	Y	HEB-AY	HEB-AW-RYA
Copper Crimp	#12 to #8 #12	1 2	Y Y	Y Y	Aluminum Crimp	#1, #2	1	N	Y	HEB-AR	N/A
Copper Crimp	#6 #10	1 2	Y Y	Y Y	Copper Crimp	#12 to #8 #12	1 2	Y Y	Y Y	HEB-BA ⁽²⁾	HEB-BW-RLC-A
Copper Crimp	#6 #10	1 2	Y Y	Y Y	Copper Crimp	#6 #10	1 2	Y Y	Y Y	HEB-BB ⁽²⁾	HEB-BW-RLC-B
Copper Crimp	#6 #10	1 2	Y Y	Y Y	Copper Crimp	#4 #8	1 2	N Y	Y Y	HEB-BC ⁽²⁾	N/A
Copper Crimp	#6 #10	1 2	Y Y	Y Y	Copper Crimp	#2 #6	1 2	N Y	Y Y	HEB-BD ⁽²⁾	N/A
Copper Crimp	#4 #8	1 2	N Y	Y Y	Copper Crimp	#4 #8	1 2	N Y	Y Y	HEB-CC ⁽²⁾	N/A
Copper Crimp	#2 #6	1 2	N Y	Y Y	Copper Crimp	#2 #6	1 2	N Y	Y Y	HEB-DD ⁽²⁾	N/A
Copper Crimp	#20, #18	1	Y	Y	Copper Crimp	#12 to #8 #12	1 2	Y Y	Y Y	HEB-ZA	N/A
Copper Setscrew	#12 to #3	1	Y	Y	Copper Setscrew	#12 to #3	1	Y	Y	HEB-JJ	HEB-JW-RLC-J
Copper Setscrew	#12 to #3	1	Y	Y	Copper Setscrew	#12 to #3	2	Y	Y	HEB-JK	HEB-JW-RYC
Copper Setscrew	#12 to #3	1	Y	Y	Aluminum Setscrew	#12 to #2	1	Y	Y	HEB-JL	N/A
Copper Setscrew	#12 to #3	1	Y	Y	Aluminum Setscrew	#12 to #2	2	Y	Y	HEB-JY	N/A
Aluminum Setscrew	#12 to #2	1	Y	Y	Aluminum Setscrew	#12 to #2	1	Y	Y	HEB-LL	HEB-LW-RLA
Aluminum Crimp	#8 #6	1 1	N Y	Y N	Aluminum Crimp	#8 #6	1 1	N Y	Y N	HEB-NN	N/A
Aluminum Crimp	#6 #4	1 1	N Y	Y N	Aluminum Crimp	#6 #4	1 1	N Y	Y N	HEB-PP ⁽²⁾	N/A
Aluminum Crimp	#3, #4 #2	1 1	N Y	Y N	Aluminum Crimp	#3, #4 #2	1 1	N Y	Y N	HEB-QQ ⁽²⁾	N/A
Aluminum Crimp	#1, #2	1	N	Y	Aluminum Crimp	#1, #2	1	N	Y	HEB-RR ⁽²⁾	N/A
Aluminum Crimp	1/0	1	N	Y	Aluminum Crimp	1/0	1	N	Y	HEB-TT ⁽²⁾	N/A
Solid Terminal for aluminum connector	#8 to #12 #10 to #14	1 1	Y N	N Y	Solid Terminal for aluminum connector	#8 to #12 #10 to #14	1 1	Y N	N Y	HEB-SS	N/A

(1) UL Recognized, Guide IZLT2, File E14853

(2) CSA Certified, Class 6225-01, File 47235

(3) CE

(4) HEB-AW-RLC-C is for (1) #4 stranded wire only.

Insulating boots for single conductor-2A0660
Dual conductor-2A0661

Contact your local Bussmann representative for other possible terminations not listed.

Panel Mounted Fuse Holders for 5 x 20mm Fuses

HTC-35M

Ratings:

Volts: — 250Vac

Amps: — 10A UL, 6.3A VDE

Fuse Access: Threaded cap

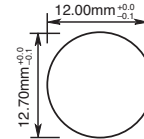
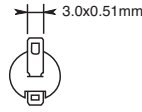
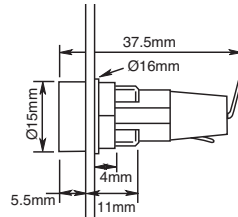

Data Sheet: 2110

HTC-40M

Ratings:

Volts: — 250Vac

Amps: — 10A UL, 6.3A VDE

Fuse Access: Screwdriver slot

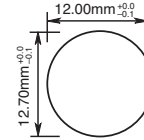
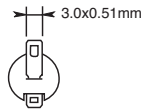
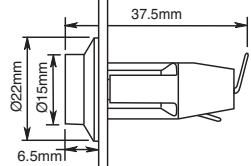

Data Sheet: 2110

HTC-55M

Ratings:

Volts: — 250Vac

Amps: — 10A UL, 6.3A VDE

Fuse Carrier: Bayonet type

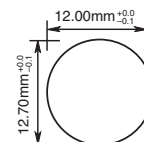
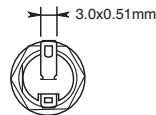
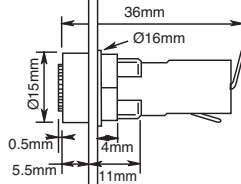

Data Sheet: 2110

HTC-70M

Ratings:

Volts: — 250Vac

Amps: — 10A UL, 6.3A VDE

Fuse Carrier: Bayonet type

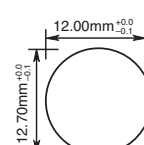
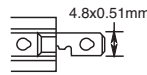
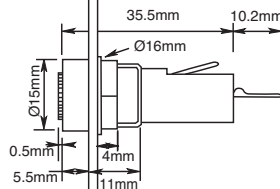

Data Sheet: 2110

Specifications

Terminals: Tin-plated brass.

Molded Materials: High temperature thermoplastic that meets the flammability ratings of UL 94V0; Glow Wire Test: 960°C per IEC 60695-2-1.

Solderability: In accordance with IEC 68-2-20.

Agency Information: cURus, VDE

Electrical: Contact Resistance: ≤ 10 megohm; Insulation Resistance: ≥ 10MΩ; Dielectric Strength ≥ 2000Vac.

Shock Safety: PC2 (fuse holders).

Packaging: Standard Qty 10 (No Prefix), Bulk Qty 100 (Prefix Catalog Number with BK/).

Panel Mounted Fuse Holders for 1/4" x 1 1/4" Fuses

HKP, HKP-L, HKP-W



Specifications

Description: Standard fuse holders.

Dimensions: See Dimensions illustration.

Ratings:

Volts: — 250V

Amps: — 30A

Catalog Numbers

Catalog Numbers	Fuse Description
HKP	—
HKP-L	HKP w/ 2250V stand-off barrier
HKP-W	HKP w/ drip-proof knob

Dimensions - in (mm)

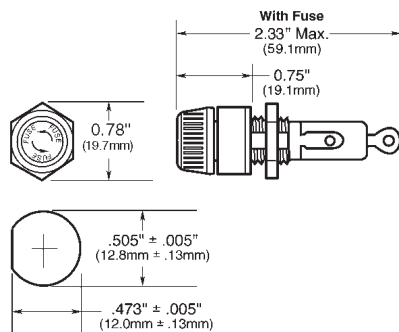

Data Sheet: 2106

HKP-BBHH, HKP-HH and HKP-LW-HH



Specifications

Description: Fuse holders with 1/4" quick-connects.

Dimensions: See Dimensions illustration.

Ratings:

Volts: — 250V

Amps: — 15A

Catalog Numbers

Catalog Numbers	Fuse Description
HKP-BBHH	HKP w/ 1/4" quick-connects, nut and washer assembled.
HKP-HH	HKP w/ 1/4" quick-connect.
HKP-LW-HH	HKP w/ drip-proof knob, 2250V stand-off barrier and 1/4" quick-connects.

Dimensions - in (mm)

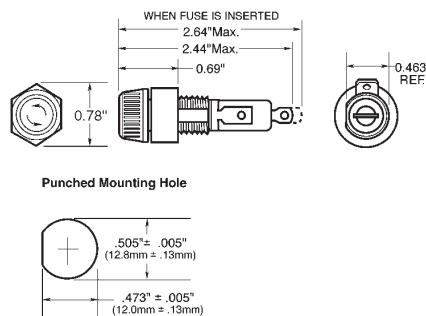

Data Sheet: 2106

HKP-OO



Specifications

Description: Snap-lock fuse holders.

Dimensions: See Dimensions illustration.

Ratings:

Volts: — 250V

Amps: — 30A

Catalog Numbers

Catalog Number	Fuse Description
HKP-OO	HKP with snap-lock

Dimensions - in (mm)

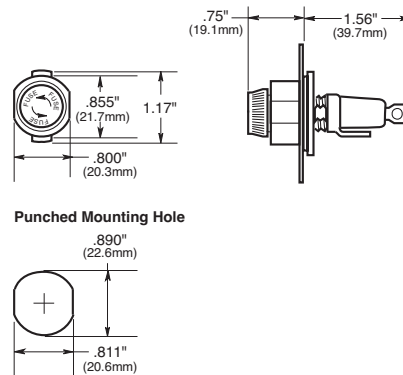

Data Sheet: 2106

Specifications

Terminals: Bayonet-type knob.
Vibration resistant.

For panels up to 5/16" (7.9mm) thick.

Agency Information: CE (HKP, HKP-L, HKP-W, HKP-OO), UL Recognized — Guide IZLT2, File E14853, CSA Certified — Class 6225-01, File 47235

Replacement Parts: Cap: 9435-1/2
Plastic Nut: BK/1A4287 (100 pieces minimum)
Metal Nut: BK/1A4806-2 (100 pieces minimum)
Washer: 9732

Panel Mounted Fuse Holders for 5 x 20mm and 1/4" x 1 1/4" Fuses

HTB Series

Specifications

Description: Fuse holders with knob-type carriers.

Dimensions: See Dimensions illustrations.

Construction: High temperature, flame retardant thermoplastic; UL Component Recognized; UL 94V0; mounting nut, spacer-black polycarbonate. Terminals: tin-plated brass.

Electrical Data: Insulation resistance (per IEC #257) — 10,000 ohms @ 500Vdc; contact resistance (per IEC #257) — 0.005 ohms Max @ 1A; standoff voltage (per IEC #257) — 480V/Mil @ 0.125" thickness.

Agency Information: CE, UL Recognized — Guide IZLT2, File E14853, 1/4" dia fuse @ 20A, 5mm dia fuse @16A @ 250V, CSA — 16A @ 250V Class 6225-01 File 47235; VDE Certified: 136128, HTB-XXM, SEMKO Certification: Ref. #0146149/01, HTB-XXM.

Mounting: Withstands 15 to 20 Lb-In torque to mounting nut when mounting fuse holder to panel.

Environmental: Operating temperature range -55°C to 85°C.

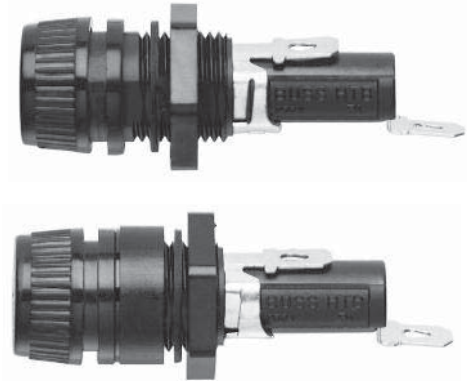

Replacement Parts

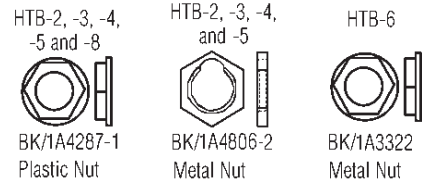

Dimensional Data - in (mm)

Knob Type Carrier	Maximum Panel Thickness	Terminal Options				Carrier Options	
		Solder/ 3/16" Quick-Connect		1/4" Quick-Connect		1/4" x 1 1/4" ("I" Equals Inches) Knob	5 x 20mm ("M" Equals Metric) Knob
		In-Line	Rt. Angle	In-Line	Rt. Angle		
		Common Dimensions: Length (Knob Type) - 1.69" (42.9mm) Plus In-Line Terminal NOTE: Plus In-Line Terminal					
	0.30"	HTB-22I-R	HTB-24I-R	HTB-26I-R	HTB-28I-R	X	
	7.62mm	HTB-22M-R	HTB-24M-R	HTB-26M-R	HTB-28M-R		X
	0.125"	HTB-42I-R	HTB-44I-R	HTB-46I-R	HTB-48I-R	X	
	3.18mm	HTB-42M-R	HTB-44M-R	HTB-46M-R	HTB-48M-R		X
	0.30"	HTB-62I-R	HTB-64I-R	HTB-66I-R	HTB-68I-R	X	
	7.62mm	HTB-62M-R	HTB-64M-R	HTB-66M-R	HTB-68M-R		X
	0.125"	HTB-82I-R	HTB-84I-R	HTB-86I-R	HTB-88I-R	X	
	3.18mm	HTB-82M-R	HTB-84M-R	HTB-86M-R	HTB-88M-R		X

Fuse holders and fuse carriers may be ordered separately.

Data Sheet: 2119

Panel Mounted Fuse Holders for 5 x 20mm and 1/4" x 1 1/4" Fuses

HTB Series



Dimensional Data - in (mm)

Screwdriver Type Carrier	Maximum Panel Thickness	Terminal Options				Carrier Options	
		Solder/ 3/16" Quick-Connect		1/4" Quick-Connect		1/4" x 1 1/4" ("I" Equals Inches) Screwdriver	5 x 20mm ("M" Equals Metric) Screwdriver
		In-Line	Rt. Angle	In-Line	Rt. Angle		
Common Dimensions: (Screwdriver Slotted) 1.75" (44.5mm) NOTE: Plus In-Line Terminal							
		0.34" (8.7mm)	0.33" (8.3mm)	0.47" (11.9mm)	0.45" (11.5mm)		
 HTB-3	0.30"	HTB-32I-R	HTB-34I-R	HTB-36I-R	HTB-38I-R	X	
	7.62mm	HTB-32M-R	HTB-34M-R	HTB-36M-R	HTB-38M-R		X
 HTB-5	0.125"	HTB-52I-R	HTB-54I-R	HTB-56I-R	HTB-58I-R	X	
	3.18mm	HTB-52M-R	HTB-54M-R	HTB-56M-R	HTB-58M-R		X
 HTB-9	0.125"	HTB-92I-R	HTB-94I-R	HTB-96I-R	HTB-98I-R	X	
	3.18mm	HTB-92M-R	HTB-94M-R	HTB-96M-R	HTB-98M-R		X

Catalog Number Build-A-Code

<input type="checkbox"/>	<input type="checkbox"/>	HTB-	<input type="checkbox"/>	<input type="checkbox"/>	<input type="checkbox"/>	S	P	FUSE CARRIER ONLY				
Packing Blank (Std.) – 10 fuse holders in a carton BK – 100 fuse holders in a cardboard shelf package		Product Symbol	Fuse Carrier I – 1/4" x 1 1/4" M – 5 x 20mm		Splash Proof Cap with O-Ring (Optional on Knob Holders Only)			<input type="checkbox"/>	<input type="checkbox"/>	<input type="checkbox"/>		
Body Configuration and Mounting Knob Holders 2 – Low Profile (Rear Panel Hex-Nut) 4 – High Profile 6 – (Front Panel Hex-Nut) 8 – Low Profile (Snap-In) Screwdriver Slotted Holders 3 – Low Profile 5 – High Profile 9 – Low Profile (Snap-In)			Rear Terminal Configuration 2 – Solder / 3/16" Quick-Connect (In-Line) 4 – Solder / 3/16" Quick-Connect (Right Angle) 6 – 1/4" Quick-Connect (In-Line) 8 – 1/4" Quick-Connect (Right Angle)		-R	RoHS Compliant			Packaging (Blank) – Std. BK/ – Bulk			
							Product Symbol FT – Knob Type (For 20, 40, 60, and 80 Series Only) ST – Screwdriver Slotted (For 30, 50, and 90 Series Only)			Fuse Carrier I – 1/4" x 1 1/4" M – 5 x 20mm		

*Profile varies with panel thickness. Holder installs through rear of panel.

Panel Mounted Fuse Holders for Indicating Type Fuses

HLD



Specifications

Description: Pin indicating for 1/4" x 1 1/4" fuses.

Dimensions: See Dimensions illustration.

Ratings:

Volts: — 250V

Amps: — 15A

Agency Information: CE, UL Recognized, File E14853, Guide IZLT2.

Catalog Numbers

Catalog Numbers*	Terminals
HLD	Solder terminals
HLD-HH	1/4" quick-connect terminals

*Use w/GBA, GLD Fuses.

Dimensions - in (mm)

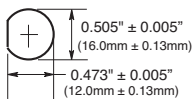
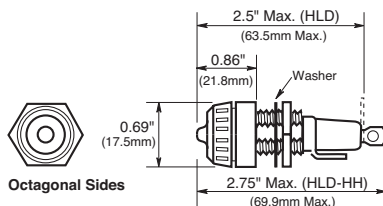

Punched Mounting Hole

HJL



Specifications

Description: Neon lamp indicating for 1/4" x 1" fuses.

Dimensions: See Dimensions illustration.

Ratings:

Volts: — 250V

Amps: — 15A

Agency Information: None

Catalog Number

Catalog Number*	Volts	Lamp Color	Knob Type
HJL	90 to 250	Clear	Oct

*Use with AGX or MKB fuses, for panels up to 1/8" thick.

Dimensions - in (mm)

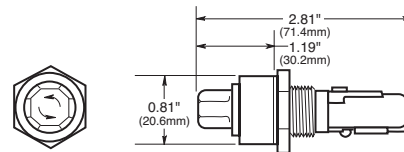

Octagonal Sides

Punched Mounting Hole

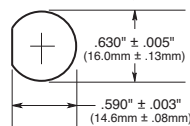

HK Series



Specifications

Description: Neon and incandescent lamp indicating for 1/4" x 1 1/4" fuses

Dimensions: See Dimensions illustration.

Ratings:

Volts: — 250V

Amps: — 15A (HKL, HKL-X)

— 20A (HKR, HKT, HKU, HKX)

Agency Information: CE, UL

Recognized, (Guide IZLT2, File E14853), CSA Certified (Class 6225-01, File 47235).

Catalog Numbers

Catalog Numbers	Lamp Volts	Knob Color/Type
HKL*	90-250	Clear/Oct
HKL-X*	90-250	Clear/FS
HKR**	22-30	Amber/Oct
HKT**	13-22	Amber/Oct
HKU**	4-6	Red/Oct
HKX**	22-33	Amber/FS

* Neon lamp — UL Recognized and CSA Certified.

** Incandescent lamp.



Flat-Sides



Octagonal Sides

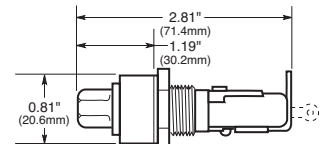

Punched Mounting Hole

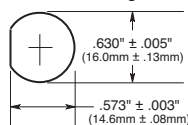

Panel Mounted Fuse Holders for 1 3/32" x 1 5/16" to 1 1/2" Fuses

HPF



#10 wire max
for solder connection

Specifications

Description: Standard fuse holders with *screw-type knob* for 1 3/32" x 1 5/16" to 1 1/2" Fuses.

Dimensions: See Dimensions illustration.

Agency Information: CE, UL Recognized, Guide IZLT2, File E14853; CSA Certified, Class 6225-01, File 47235.

Flammability Rating: UL 94HB.

Terminals: Combination 1/4" quick-connect/solder terminals.

Catalog Numbers

Catalog Numbers	Amp Ratings	Volts AC	Fuse Description
HPF	30 ²	600	1 1/2" (38.1mm)
HPF-C	30 ²	600 ²	1 1/2" (38.1mm) clear knob.
HPF-L	5	600	BBS, 1 3/8" x 1 3/8" fuses.
HPF-EE	15	600	SC 0-15, 1 3/8" x 1 3/8" fuses.
HPF-JJ	20	600	SC 20, 1 3/8" x 1 3/8" fuses.
HPF-FF ¹	30 ²	480	SC 25 & 30, 1 3/8" x 1 3/8" fuses.
HPF-RR	30 ²	600	KTK-R, LP-CC & FNQ-R Class CC fuses.
HPF-WT	30 ²	600	Splash-proof knob, 1 3/8" x 1 1/2" (38.1mm)

¹ No CSA Certification

² 20A max when used with quick-connect terminals.

³ HPF-C ratings for CSA-15A, 250V

Dimensions - in (mm)

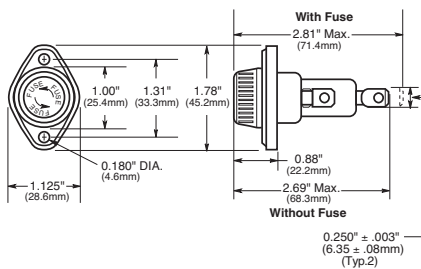

HPS



Specifications

Description: Standard fuse holders with *bayonet-type knob* for 1 3/32" x 1 5/16" to 1 1/2" fuses.

Dimensions: See Dimensions illustration.

Agency Information: CE, UL Recognized, Guide IZLT2, File E14853; CSA Certified, Class 6225-01, File 47235.

Flammability Rating: UL 94HB.

Terminals: Combination 1/4" quick-connect/solder terminals.

Catalog Numbers

Catalog Symbol	Amp Ratings	Volts AC	Fuse Description
HPS	30 ^{2,3}	600	1 3/8" x 1 1/2"
HPS-L	5	600	BBS, 1 3/8" x 1 3/8" fuses.
HPS-EE ¹	15	600	SC 0-15, 1 3/8" x 1 3/8" fuses.
HPS-JJ ¹	20	600	SC 20, 1 3/8" x 1 3/8" fuses.
HPS-F-EE ¹	15	600	Sleeve on body, leaded for 1 3/8" x 1 3/8" fuses.
HPS-FF ^{1*}	30 ²	480	SC 25 & 30, 1 3/8" x 1 3/8" fuses.
HPS-RR ^{1*}	30 ²	600	KTK-R, LP-CC, FNQ-R Class CC fuses.

*-EE, -JJ, -FF and -RR versions are UL Recognized for applications requiring branch circuit protection.

¹ No CSA Certification

² 20A max when used with quick-connect terminals.

³ HPS rated at 250V for CSA

Dimensions - in (mm)

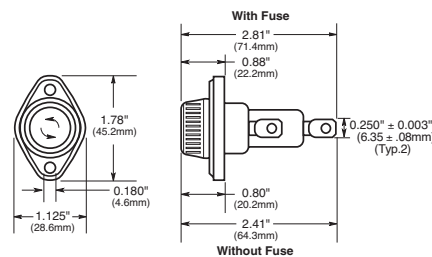

HPG



HPD



Specifications

Description: Standard fuse holders with *bayonet-type knob* for 1 3/32" x 1 1/2" fuses.

Dimensions: See Dimensions illustrations.

Agency Information: CE, UL Recognized, (Guide IZLT2, File E14853).

Flammability Rating: UL 94V0 - fuse holder body UL 94HB - Knob.

Catalog Numbers

Catalog Numbers	Amp Ratings	Volts AC	Fuse Description
HPG [*]	30 ¹	600	1 3/8" x 1 1/2" fuses
HPG-EE [*]	15	600	SC 0-15, 1 3/8" x 1 3/8" fuses.
HPD ^{**}	30 ¹	600	1 3/8" x 1 1/2" fuses

¹ 20A max when used with quick-connect terminals.

*HPG and HPG-EE has combination 1/4" quick-connect/solder terminals on both side (load) and rear (line) terminals.

**HPD has combination 1/4" quick-connect/solder terminal on side (load) terminal only. Rear (line) terminal is 3/8" shorter than HPG. Rear terminal solder only.

Dimensions - in (mm)

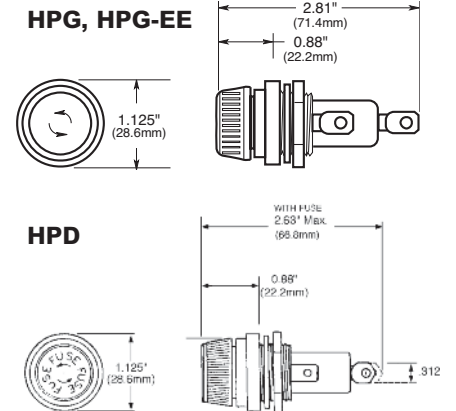

Panel Mounted Fuse Holders for 1³/₃₂" x 1 1/2" Fuses

HPM



Specifications

Description: Standard fuse holder with **screw-type knob** for 1³/₃₂" x 1 1/2" fuses.

Dimensions: See Dimensions illustration.

Ratings:

Volts: — 600Vac/dc

Amps: — 30A¹

¹ 20A max when used with quick-connect terminals.

Agency Information: CE, UL Recognized, Guide IZLT2, File E14853; CSA Certified, Class 6225-01, File 47235.

Flammability Rating: UL 94HB.

Catalog Numbers

Catalog Numbers	Description
HPM	1/2" quick-connect/solder
HPM-D	Splash-resistant knob ²

² HPM-D has 1/4" quick-connect/solder terminal on rear (load) terminal only. The side (line) terminal is 1/2" quick-connect only.

Dimensions - in (mm)

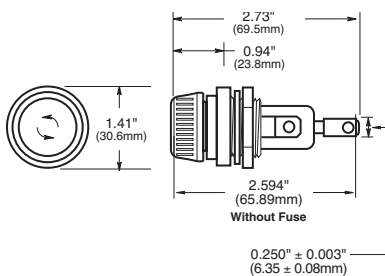

Nut Torque: 30 lb-in.

Replacement Knob:

Catalog Number: BK/9789-Y2
(50 pieces)

Data Sheet: 2112

HPC-D

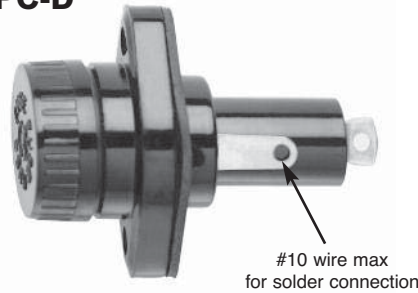

Specifications

Description: Fuse holder with **screw-type knob** for 1³/₃₂" x 1 1/2" fuses. Supplied with O-ring and panel gasket.

Dimensions: See Dimensions illustration.

Ratings:

Volts: — 600Vac/dc

Amps: — 30A¹

¹ 20A max when used with quick-connect terminals.

Agency Information: CE, UL Recognized, Guide IZLT2, File E14853.

Flammability Rating: UL 94HB.

Catalog Numbers

Catalog Number	Description
HPC-D	Mount in panels up to 1/4" thick.

Replacement knob - BK/9987SA

Dimensions - in (mm)

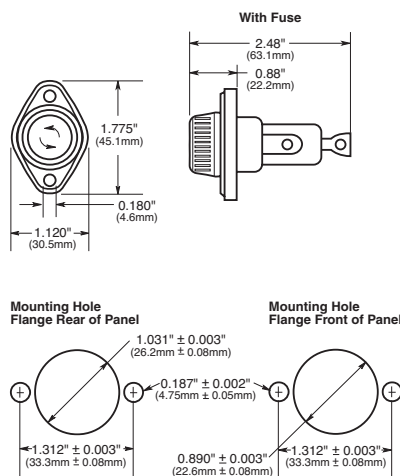

Data Sheet: 2109

HPS2



Specifications

Description: For fuse size 1³/₃₂" x 1 1/2", meeting UL 1598 requirement that both poles be removed simultaneously.

Dimensions: See Dimensions illustration.

Ratings:

Volts: — 600V@30A

Amps: — 0-30A¹

¹ 20A max when used with quick-connect terminals.

Agency Information: UL 4248 recognized, (Guide IZLT2, File E14853), CSA certified: (Class 6225-01, File 47235).

Flammability Rating: UL 94V0.

Terminals: 1/4" quick-connect/solder.

Catalog Numbers

Catalog Numbers	Description
HPS2	Standard 10-in carton
BK/HPS2	Bulk 100-in carton

Dimensions - in (mm)

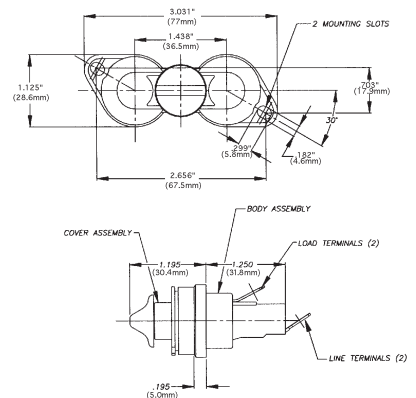

Panel Mount Hole Dimensions

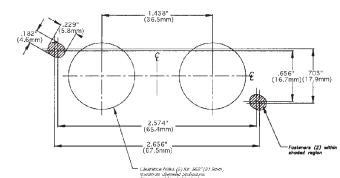

Data Sheet: 2140

Fuse Blocks for 1/4" x 1 1/4" Fuses

Series 8000



Specifications

Description: Bolt-in and snap-in mounting for 1/4" x 1 1/4" fuses.

Construction: Blocks are molded flame retarded thermoplastic. Clips are spring-bronze.

Ratings:

Volts: — 300V

Amps: — 25A (See Catalog Numbers table)

Agency Information: CE, UL Recognized ; File E14853, Guide IZLT2, CSA Certified Class 6225-01, File 47235.

Anti-Rotation Pin: Single-pole blocks may be ordered without the anti-rotational pin simply by adding an "X" to the number of poles (Example: BK/S-8000-1X).

Carton Quantity: 10; shelf package: 100.

Bulk Carton: Single-pole and 2-pole fuse blocks – 1,000; Multiple-pole fuse blocks – 3- to 8-pole: 200; 9- to 12-pole: 50. When ordering bulk quantities, prefix "BK/" to catalog number: (Example: BK/S-8001-1-SNP).

Catalog Numbers

Bolt-in Mounting

Basic Catalog Numbers	Series	Terminal	Angle	Agency Maximums	Poles (Suffix)
S-8001-	8000	Solder	0°	UL 25A	1 - 12
S-8002-			40°	CSA 21A	
S-8101-	8100	3/16" Quick Connect	0°	UL 20A	
S-8102-			40°	CSA 13A	
S-8201-	8200	1/4" Quick Connect	0°	UL 20A	
S-8202-			40°	CSA 16A	
S-8203-	8300	Screw	—	UL 30A	
S-8301-			—	CSA 25A	

Snap-in Mounting

Catalog Numbers	Series	Terminal	Angle	Agency Maximums	Poles (Suffix)
S-8001-1-SNP	8000	Solder	0°	UL 25A	Available only in single pole
S-8002-1-SNP			40°	CSA 21A	
S-8101-1-SNP	8100	3/16" Quick Connect	0°	UL 20A	
S-8102-1-SNP			40°	CSA 13A	
S-8201-1-SNP	8200	1/4" Quick Connect	0°	UL 20A	
S-8203-1-SNP			Side	CSA 16A	

Catalog Number Build-A-Code



Catalog Code

BK/ S-8 0 00 -00

Prefix for Bulk Packing
 Series 8000
 Product Line
 Type Terminal
 "0" - Solder
 "1" - 3/16" Quick Connect
 "2" - 1/4" Quick Connect
 "3" - Screw
 Terminal Angle
 "01" - straight (0.)
 "02" - 40
 "03" - side
 Number of Poles (1-12)
 *Available only in single pole

Data Sheet: 2101

Single-Pole Fuse Blocks

Specifications

Description: Single-pole fuse block for 1/4" x 1 1/4" (6.4 x 31.8mm) size fuses.

Dimensions: See Dimensions illustrations.

Construction: Bakelite base width 1/2" (12.7mm); spring-bronze, bright tin-lead plate clips.

Ratings:

Volts: — 250V

Amps: — 30A



4405 - 0° Solder terminals with integral terminal and clip

Dimensions - in (mm)

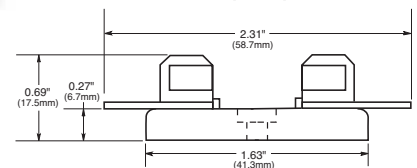

4406 - Side solder terminal



4574 - Spare fuse block

Dimensions - in (mm)

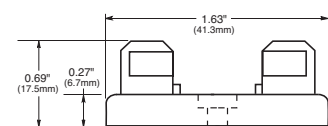

2499 - Side quick-connect

Agency Information: UL Recognized, Guide IZLT2, File E14853

Terminals: 1/4" (6.4mm); 15A, 250V

Dimensions - in (mm)

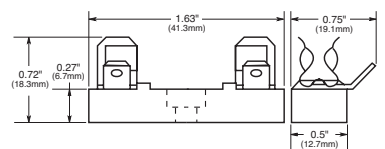

Note: Mounting screw hole diameter is 0.147" (3.7mm). Counterbore diameter, 0.636" (8.0mm). Max Mounting Screw No. 6.

Fuse Blocks for 1/4" x 1" Fuses

3828 Series



Specifications

Description: Fuse block for 1/4" x 1" (6.4 x 25.4mm) fuses with solder terminals.

Dimensions: See Dimensions illustration.

Ratings:

Volts — 250V

Amps — 30A

Mounting: Mounting screw hole diameter is 0.147" (3.7mm), diameter. Max mounting screw No. 6.

Catalog Numbers

Catalog Numbers	Poles	*Base Length - in (mm)
3828-1	1	1/2 (12.7)
3828-2	2	1 1/8 (28.6)
3828-3	3	1 3/4 (44.5)
3828-4	4	2 3/8 (60.3)
3828-5	5	3 (76.2)
3828-6	6	3 3/8 (92.1)
3828-7	7	4 1/4 (108.0)
3828-8	8	4 7/8 (123.8)
3828-10	10	6 1/8 (155.6)
3828-12	12	7 3/8 (187.3)

*Small phenolic base, base width 1 3/8" (34.9mm)

Dimensions - in (mm)

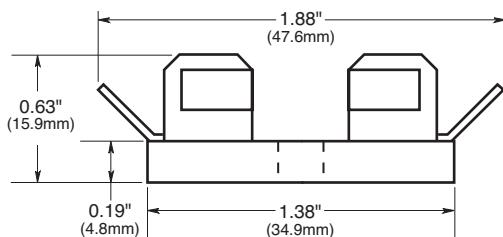

4520 and 4393



Specifications

Description: Single-pole fuse block for 1/4" x 1" fuses.

Dimensions: See Dimensions illustrations.

Construction: Bakelite with 1/2" (12.7mm) width base. Spring-bronze, bright tin-lead plated clips.

Ratings:

Volts — 250V

Amps — 30A

Mounting: Mounting screw hole diameter is 0.147" (3.7mm), counterbore 0.636" (8.0mm) diameter. Max mounting screw No. 6.

Catalog Numbers

Catalog Numbers	Description
4520	Integral clip and straight solder terminals
4393	Spare fuse block

No. 4520 - Integral clip and straight solder terminals

Dimensions - in (mm)

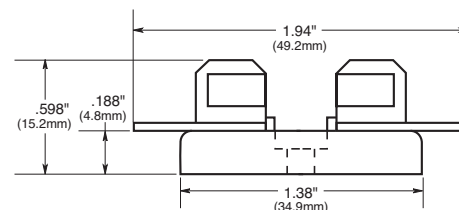

No. 4393 - Spare fuse block

Dimensions - in (mm)

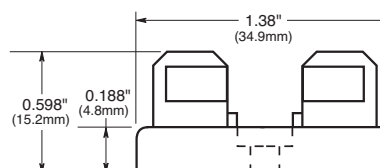

Blocks for 1 3/32" X 1 1/2" Fuses

3743



Specifications

Description: Add-on fuse blocks for 1 3/32" X 1 1/2" (10.3 X 38.1mm) fuses. Single pole blocks lock into each other and can be added at any time. Each has a single end barrier.

Dimensions: See Dimensions illustration.

Ratings:

Volts: — 600Vac/dc

Amps: — 30A

Agency Information: CE, UL Recognized Guide IZLT2, File E14853.

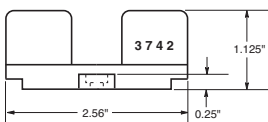
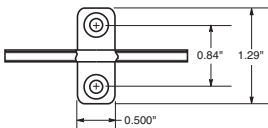

3742—End Barrier Only

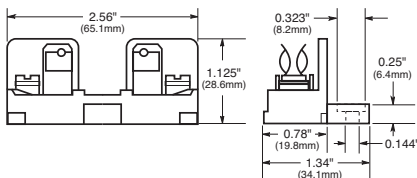

3723—Block and end barrier marking strip. Length is 9 3/8" (23.8cm).

Note: Mounting screw hole is 0.147" (3.7mm) dia. Counterbore, 0.636" (8mm) dia. Max. mounting screw No. 6.

Data Sheet: 2104

3835 Series

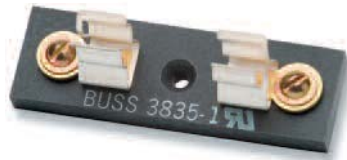

Specifications

Description: Multiple pole fuse blocks for 1 3/32" X 1 1/2" (10.3 X 38.1mm) fuses.

Dimensions: See Dimensions illustration.

Ratings:

Volts: — 250Vac/dc

Amps: — 30A

Agency Information: CE

Catalog Numbers

Catalog Numbers	Poles	Base* Width In (mm)
3835-1	1	2 7/32 (21.4)
3835-2	2	1 1/16 (46.0)
3835-3	3	2 25/32 (70.6)
3835-4	4	3 3/4 (95.2)
3835-5	5	4 23/32 (119.9)
3835-6	6	5 11/16 (144.5)
3835-7	7	6 21/32 (169.0)
3835-8	8	7 5/8 (193.7)
3835-9	9	8 13/16 (218.8)
3835-10	10	9 9/16 (242.9)
3835-12	12	11 1/2 (292.1)

*Base length: 2 3/4" (69.9mm)

Dimensions - in (mm)

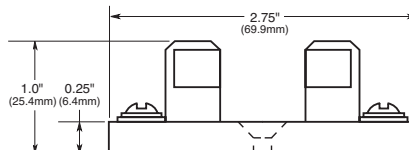

Note: Mounting screw hole diameter is 0.148" (3.7mm). Countersink, 0.313" (7.9mm). Max. mounting screw No. 6.

4421 and 4515



Specifications

Description: Single pole fuse blocks for 1 3/32" X 1 1/2" (10.3 X 38.1mm) fuses.

Dimensions: See Dimensions illustration.

Ratings:

Volts: — 250Vac/dc (or less)

Amps: — 30A

Agency Information: CE

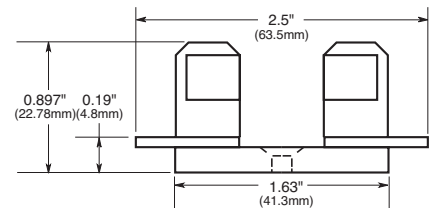

4421—Solder Terminals Base width 5/8" (15.9mm)

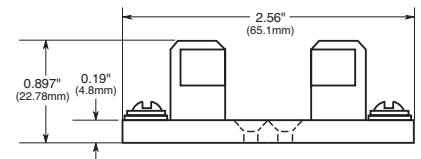

4515—Screw Terminals Base width 3/4" (19mm)

Note: Mounting screw hole diameter is 0.147" (3.7mm). Countersink, 0.312" (7.9mm). Max. mounting screw No. 6.

Rail Mount Fuse Blocks and Holders

NDNF1-WH

Specifications

Description: Fuse holding rail mount terminal block.

Circuit Jumper: JF1, 2 circuits

Fuse Size: 1³/₃₂" X 1 1¹/₂"* (KTK, FNQ, PVM).

Poles: 1

Wire Range: AWG #8-22 Cu.

Ratings:

Volts: — 600V

Amps: — 30A

Mounting Options: 35mm DIN-Rail, C-rail

Fuse Pullers: • PF1 (standard)
• neon or incandescent bulb

*LPF1 (lighted neon or incandescent bulb).

Torque Rating: 18 lb-in

Operating Temperature: 105°C

Catalog Numbers

Catalog

Number	Color
NDNF1-WH	White

Fuse Pullers (Optional): PF1

Lighted neon or incandescent lamp:

Catalog

Numbers	Voltage
LPF1-24	24
LPF1-120	120
LPF1-120-C	120
LPF1-220	220
LPF1-440	440



NDNLF1-WH

Specifications

Description: Rail mount fuse holder.

Circuit Jumper: JF1, 2 circuits.

Fuse Size: 1/4" X 1 1/4" (Bussmann AGC, MDL or equivalent).

Poles: 1

Wire Range: AWG #8-22 Cu.

Ratings:

Volts: — 600V

Amps: — 30A (NDND1 non-fused)

— 15A (NDNFD1, 600V/CSA, fused)

— 15A (NDNLF1*fused, indicating)

*WH24 - 24V White, WH-90Vdc-600Vdc, 115Vac-600Vac White

Agency Information: CE

Mounting Options: 35mm DIN-Rail, C-rail

Marking Tape: MT12-1-2

Torque Rating: 18 lb-in

Operating Temperature: 105°C

Agency Information: CSA File 15364

Catalog Numbers

Catalog

Number	Color	Indicator
NDND1-WH	White	NO
NDNFD1-WH	White	NO
NDNLF1-WH	White	90Vdc-600Vdc 115Vac-600Vac
NDNLF1-WH 24	White	24V



Power Distribution & Terminal Blocks

Section Contents	Page
Selection table for SCCR PDBs & Power terminal blocks	324
Power distribution blocks	
Series PDBFS enclosed, with high SCCR	325
Series PDB with high SCCR	326
Power terminal blocks	
Series 163	327-328
Series 11675 2- to 12-Pole quick-connect	329
Series 11725 2- to 4-Pole quick-connect	329
Series 160, 162, 163 & 165	329
Series 162, 163 & 165 power stud terminal blocks . . .	330
Series 160, 162, 163 & 165 power splicer blocks . . .	330
Series 14002 Barrier terminal blocks	331
Series 14004 Dead front terminal block	331



Scan this tag to get the latest product information for the Power Distribution Blocks.

Selection Table for SCCR Power Distribution Blocks and Power Terminal Blocks

Short-Circuit Current Rated Power Distribution Blocks

Bussmann offers three distinctly different styles of short-circuit current rated power distribution blocks (PDBs) and power terminal blocks (PTBs) to match different application needs. The differences are whether the power distribution blocks are enclosed or not, and whether they are UL 1953 Listed PDBs or UL 1059 Recognized PTBs, which have different minimum spacing requirements. The table on this page can assist in the selection of the right series for your application requirements.

Why these are important?

Assembly short-circuit current ratings (SCCRs) are now required in the 2011 NEC® and UL 508A Listed Industrial

Control Panels. Marking the SCCR on Industrial Control Panels (NEC® 409.110), Industrial Machinery Electrical Panels (NEC® 607.3(A)), and HVAC equipment (NEC® 440.4(B)) is required by the National Electrical Code. PDBs or PTBs not marked with a SCCR, typically are the weakest link and may limit an assembly to no more than 10kA SCCR. The PDBFS and PDB Series have increased spacing required where used in feeder circuits in equipment listed to UL508A (UL1059 PTBs must be evaluated for proper spacings). Also, for building wiring systems, the PDBFS Series and PDB Series power distribution blocks can be used to meet the new 2013 NEC® requirements in section 376.56(B) for PDBs in wireways.

Selection Table

Description	Catalog Page	UL	Enclosed	High SCCR*	Spacing** 1" Air 2" Surface	Industrial Control Panels UL 508A Branch Circuit	Industrial Control Panels UL 508A Feeder Circuit	HVAC UL 1995	Wireways NEC® 376.56(B) (Requires UL 1953)
Series PDBFS	325	UL 1953 Listed	Yes†	Yes	Yes	Yes	Yes	Yes	Yes
Series PDB	326	UL 1953 Listed	No***	Yes	Yes	Yes	Yes	Yes	Yes w/optional cover

†IP20 Finger-safe under specific conditions, see datasheet 1149.

*When protected by proper fuse class with maximum ampere rating specified or less.

See **PDB Spacing Requirements for Equipment table below.

***Optional covers are available. Not IP20, but provide a safety benefit.

****No, except: Yes, if single pole units installed with proper spacings.

PDB & PTB Minimum Spacing Requirements for Equipment

UL Standard	Spacing between live parts of opposite polarity		Spacing between live parts and grounded parts or enclosure @600V
	Through air @600V	Over surface @600V	
508A Feeder Circuits	1"	2"	1"
508A Branch Circuits	3/8"	1/2"	1/2"
1995 HVAC	3/8"	1/2"	1/2"

Note: Refer to Specific UL standards for complete spacing details.



Series PDBFS



Series PDB

Series PDBFS of Power Distribution Blocks

Feature/Benefits

- Enclosed, safer installation; IP20 finger-safe under specific conditions
- High short-circuit current ratings up to 200kA: PDBs do not have to be the weak link in achieving high SCCR for an industrial control panel
- Small footprint saves panel space
- Listed to UL 1953 which has minimum spacing requirements at 600V of at least 1" through air and 2" over surface required for feeders in UL 508A Industrial Control Panels
- For 2D CAD drawings visit www.cooperbussmann.com



Electrical

- 600Vac/dc (UL 1953), 690Vac/dc (IEC)
- IP20 finger-safe under specific conditions
- Short-circuit current ratings up to 200kA, see table
- Ampacities up to 760 amps
- Cu wire range 14 AWG to 500 kcmil or 2.5 to 240 mm²

Mechanical

- DIN-Rail or panel mount; PDBFS330 & PDBFS504 panel mount only
- Captive termination screws; screws do not get misplaced
- Wire ready: captive termination screws shipped backed out to save time on conductor installations
- Sliding DIN-Rail latch for easy mounting
- Single pole, gang mountable for multiple pole applications with interlocking dovetail accessory (optional)
- Flammability, UL 94V0
- Tin-plated Al connectors suitable for Cu conductors
- Elongated hole for panel mounting; easier mounting with greater flexibility in matching up with drilled panel holes
- Part 2A1279: Interlocking dovetail pin accessory
One pin interlocks two units, two pins to interlock three units
- DIN-Rail end anchors required to prevent damage to block when torquing

Agency/Standards

- UL Listed 1953, Guide QPQS, File E256146
- CSA Certified, Class 6228-01, File 47235
- IEC 60947-7-1
- IEC 60529, IP20 (finger-safe) under specific wiring conditions

Series PDBFS

Electrical		Terminal Copper Conductor Capability			Short-Circuit Current Rating Data							
		Line	Load	Configuration	Conductors		Max Fuse Class & Amp**				SCCR	
Catalog Number <small>(All Single Pole)</small>	Amps	Wire Range	Wire Range	Openings per Pole		Line AWG or kcmil	Load AWG or kcmil	J LPJ	T JJS JJN	RK1 LPS-RK LPN-RK		RK5 FRS-R FRN-R
				Line	Load							
PDBFS204	175A	2/0 to 8 AWG 70 to 10 mm ²	2/0 to 8 AWG 70 to 10 mm ²			2/0 to 8	2/0 to 8	200	200	100	60	200kA
PDBFS220	175A	2/0 to 8 AWG 70 to 10 mm ²	4 to 14 AWG 25 to 2.5 mm ²			2/0 to 8	4 to 12	200	200	100	60	200kA
							4 to 14	175	175	100	30	100kA
								200	200	100	60	50kA
PDBFS303	310A	350kcmil to 6 AWG 185 to 16 mm ²	350kcmil to 6 AWG 185 to 16 mm ²			350 to 6	350 to 6	400	400	200	100	200kA
PDBFS330	380A	500kcmil to 6 AWG 240 to 16 mm ²	2 to 14 AWG 35 to 2.5 mm ²			500 to 6	2 to 6	400	400	200	100	200kA
							2 to 14	200	200	100	60	50kA
								175	175	100	30	100kA
PDBFS377	570A	300kcmil to 4 AWG 150 to 12 mm ²	4 to 14 AWG 25 to 2.5 mm ²			300	4 to 8	600	600	400	200	200kA
							4	400	400	200	100	100kA
							4 to 14	200	200	100	60	50kA
PDBFS500	620A	350kcmil to 4 AWG 185 to 12 mm ²	350kcmil to 4 AWG 185 to 12 mm ²			350 to 4	350 to 4	600	600	400	200	200kA
PDBFS504	760A	500kcmil to 6 AWG 240 to 16 mm ²	500kcmil to 6 AWG 240 to 16 mm ²			500	500	600	800*	600	200	200kA
						500 to 6	500 to 6	600	600	400	200	100kA

Ampacities 75C per NEC® Table 310.16 and UL508A Table 28.1

*Class L 800A (KRP-C 800_SP) or less fuses suitable for this particular SCCR case.

** Class G 60A (SC-60) or less or Class CC 30A (LP-CC-30, FNQ-R-30, KTK-R-30) or less are suitable for all SCCRs in this table.

Data Sheet: 1049

Series PDB of Power Distribution Blocks



Electrical

- 600Vac/dc (UL 1953)
- Short-circuit current ratings up to 200kA, see table
- Wire range 14 AWG to 350 kcmil Cu
- Spacing between uninsulated opposite polarities or ground meets UL 1953 which requires at least 1" through air and 2" over surface
- Ratings available with circuit breakers

Mechanical

- Panel mount
- Flammability, UL 94V0
- Tin-plated Al connectors suitable for Cu conductors

Feature/Benefits

- High short-circuit current ratings up to 200kA. These PDBs do not have to be the weak link in achieving high SCCR for an industrial control panel
- Listed to UL 1953 which has minimum spacing requirements at 600V of at least 1" through air and 2" over surface required for feeder in UL 508A Industrial Control Panels
- For 2D CAD drawings visit www.cooperbussmann.com

Optional covers

Covers are ordered for each individual pole, i.e., three 1-pole covers for 3-pole block, see table A.

Except PDB321 blocks have one cover for 1-, 2- or 3-pole versions, see table B.

Table A

Block	Cover
PDB2XX-(pole):	CPB162-1
PDB3XX-(pole):	CPDB-1

Table B

Block	Cover
PDB321-1	CPDB-1
PDB321-2	CPDB-2
PDB321-3	CPDB-3

Agency/Standards

- UL Listed 1953, Guide QPQS, File E256146

Series PDB

Catalog Number - Pole		Terminal Copper Conductor Capability			Short-Circuit Current Rating Data							
		Line	Load	Configuration	Conductors		Max Fuse Class & Amp*				SCCR	
		Wire Range	Wire Range	Openings per Pole Line Load	Line AWG or kcmil	Load AWG or kcmil	J LPJ	T JJS JJN	RK1 LPS-RK LPN-RK	RK5 FRS-R FRN-R		
PDB204-1 PDB204-3	175A	2/0 - 8 AWG	2/0 - 8 AWG		2/0 - 8	2/0 - 8	200	200	200	60		200kA
PDB220-1 PDB220-3	175A	2/0 - 8 AWG	4 - 14 AWG		2/0 - 8	4 - 12 14	200 175 [†] 200 [†]	200 175 [†] 200 [†]	200 [†] 100 [†] 100 [†]	60 [†] 60 [†] 60 [†]	200kA 100kA 50kA	
PDB280-1 PDB280-3	175A	2/0 - 8 AWG	1/4-20 X 3/4 STUD		2/0 - 8	Stud	200	200	100	60	200kA	
PDB321-1 PDB321-2 PDB321-3	175A	2/0 - 8 AWG	4 - 14 AWG		2/0 - 8	4 - 12 14	400 400 [†] 175 [†]	400 400 [†] 175 [†]	200 [†] 400 [†] 100 [†]	100 [†] 100 [†] 60 [†]	200kA 100kA 100kA	
PDB323-1 PDB323-3	310A	300kcmil - 4 AWG	4 - 12 AWG		300 - 4	4 - 8 10 - 12	400 400 [†] 175 [†]	400 400 [†] 175 [†]	200 [†] 400 [†] 100 [†]	100 [†] 100 [†] 60 [†]	200kA 100kA 100kA	
PDB370-1 PDB370-3	310A	350kcmil - 4 AWG	4 - 14 AWG		350 - 4	4 - 8 10 - 14	400 400 [†] 175 [†]	400 400 [†] 175 [†]	200 [†] 400 [†] 100 [†]	100 [†] 100 [†] 60 [†]	200kA 100kA 100kA	
PDB371-1 PDB371-3	310A	350kcmil - 4 AWG	(6) 2 - 12 AWG (3) 1/0-12		350 - 4	1/0 - 6 8 - 12	400 400 [†] 175 [†]	400 400 [†] 175 [†]	200 [†] 400 [†] 100 [†]	100 [†] 100 [†] 60 [†]	200kA 100kA 100kA	

Ampacities 75°C per NEC® Table 310.16 and UL508A Table 28.1

* Class G 60A (SC-60) or less or Class CC 30A (LP-CC-30, FNQ-R-30_SP, KTK-R-30) or less are suitable for all these SCCR in this table.

† Higher SCCR may be available, check data sheet 1049.

Data Sheet: 1049

Series 163 Power Terminal Blocks

163 Series

Replaces Bussmann 164 Series

Specifications

Description: Power terminal block.

Dimensions: See Dimensions illustrations.

Construction: Tin-plated aluminum connectors.

Poles: 1- to 3-Poles, See Catalog Numbers table on the following page.

Wire Range: See Catalog Numbers table on the following page.

Ratings:

Volts: — 600Vac/dc

Amps: — See catalog Numbers table on the following page.

SCCR: — 10kA per UL 508A table SB4.1 (except for select products noted in table)

Agency Information: CE, UL Recognized: Guide XCFR2, UL E62622, General Industrial Class per UL1059, CSA Certified: CSA 053787

Flammability Rating: UL 94V0



Dimensions

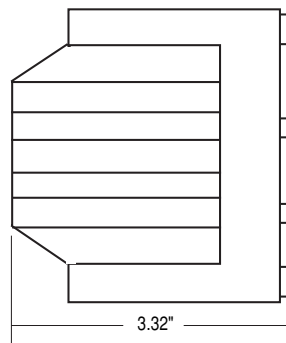
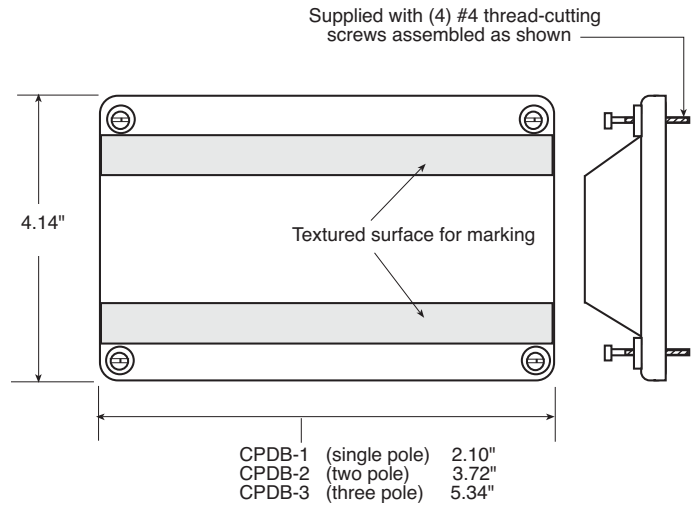
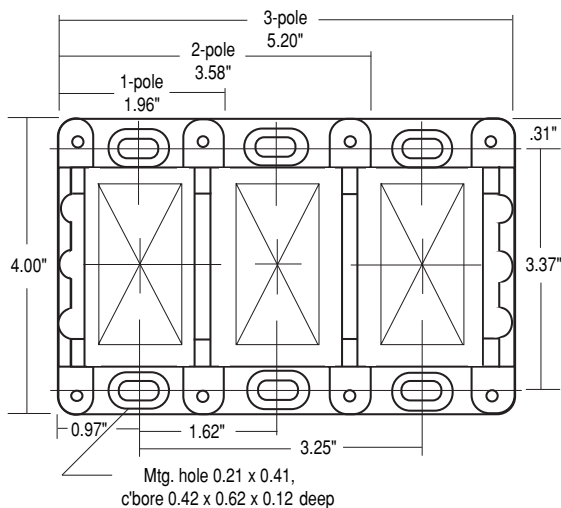

(See Following Page for Ratings)

Data Sheet: 1049

Series 163 Power Terminal Blocks

Catalog Numbers

Catalog Numbers	Wire Size (Poles) Lineside	(Poles) Loadside	Amps/ Pole	Line/Load
16301*	250kcmil-6 AWG Cu Only	250kcmil-6 AWG Cu Only	255	
16303	350kcmil-6 AWG Cu-Al	350kcmil-6 AWG Cu-Al	310	
16306	500kcmil-6 AWG Cu-Al	500kcmil-6 AWG Cu-Al	380	
16321**	2/0-14 AWG CU, 2/0-8AI	(6)4-14 AWG Cu, 4-8 AWG AI	175	
16323**	350kcmil-6 AWG Cu-Al	(6)4-14 AWG Cu, 4-12 AWG AI	310	
16325	(2)2/0-14 AWG Cu, 2/0-8 AWG AI	(6)4-14 AWG Cu, 4-8 AWG AI	350	
16330	500kcmil-6 AWG Cu-Al	(6) 2-14 AWG Cu, 2-12 AWG AI	380	
16332	350kcmil-6 AWG Cu-Al	(3) 2-14 AWG Cu, 2-8 AWG AI (2) 1/0-14 AWG Cu, 1/0-8 AWG AI	310	
16335	500kcmil-6 AWG Cu-Al	(3) 2-14 AWG Cu, 2-8 AWG AI (2) 1/0-14 AWG Cu, 1/0-8 AWG AI	380	
16370**	350kcmil-6 AWG Cu-Al	(12)4-14 AWG Cu, 4-12 AWG AI	310	
16371**	350kcmil-6 AWG Cu-Al	(6) 2-14 AWG Cu, 2-8 AWG AI (3) 1/0-14 AWG Cu, 1/0-8 AWG AI	310	
16372	350kcmil-6 AWG Cu-Al	(21) 10-14 AWG Cu, 10 AWG AI	310	
16373	350kcmil-6 AWG Cu-Al	(14) 10-14 AWG Cu, 10 AWG AI (3) 1/0-14 AWG Cu-Al	310	
16375	600kcmil-2 AWG Cu-Al	(12)4-14 AWG Cu, 4-12 AWG AI	420	
16376	600kcmil-2 AWG Cu-Al	(6) 2-14 AWG Cu, 2-8 AWG AI (3) 1/0-14 AWG Cu, 1/0-8 AWG AI	420	
16377	(2)300kcmil-4 AWG Cu-Al	(12)4-14 AWG Cu, 4-12 AWG AI	570	
16378	500kcmil-6 AWG Cu-Al	Stud Size (2) 1/4-20 x 1	380	
16383	500kcmil-6 AWG Cu-Al	Stud Size (1) 3/8-16 x 1	380	
16390	3/8-16 x 1 1/8 Stud Size	3/8-16 x 1 1/8 Stud Size	250	
16394	1/2-13 x 1 1/8 Stud Size	1/2-13 x 1 1/8 Stud Size	400	
16395	3/8-16 x 1 1/8 Stud Size	(2) 1/4-20 x 3/8 Stud Size	310	

*Copper connectors for use with copper wire only.

**SCCR up to 200kA

Ordering Information

163 Series blocks are available in 1-, 2- or 3-poles. To order: Basic Catalog Number + Number of poles.

Examples: 16301-1 = one-pole block
16301-3 = three-pole block

Data Sheet: 1049

Power Terminal Blocks

Series 11675

Specifications

Description: Screw connection line side, (3) 0.250" quick-connect load side power terminal block.

Poles:

2- to 12-poles.

Wire Range:

8 – 14 AWG Cu.

Ratings:

Volts: — 250Vac/dc

Amps: — Up to 40A

SCCR: — 10kA per UL 508A table SB4.1

Agency Information: CE, Guide XCFR2, UL E62622; CSA 47235.

Torque Rating: 9 lb-in max.

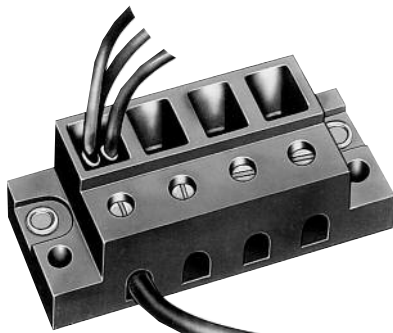

Catalog Numbers

Catalog Numbers	Poles	Catalog Numbers	Poles
11675-2	2	11675-8	8
11675-3	3	11675-9	9
11675-4	4	11675-10	10
11675-5	5	11675-11	11
11675-6	6	11675-12	12
11675-7	7		

Series 11725

Specifications

Description: Screw connection line side, (4) 0.250" quick-connect load side power terminal block.

Poles: 2-, 3- or 4-poles.

Wire Range: 2 – 14 AWG Cu/8 AWG Al.

Ratings:

Volts: — 600Vac/dc

Amps: — Up to 70A

SCCR: — 10kA per UL 508A table SB4.1

Agency Information: CE, UL Guide XCFR2, E62622; CSA 47235.

Torque Rating: 45 lb-in max.



Catalog Numbers

Catalog Numbers	Poles
11725-2	2
11725-3	3
11725-4	4

Series 160, 162, 163 & 165

Specifications

Description: Power terminal blocks.

Construction: Molded black thermoplastic.

Wire Range: See Catalog Numbers table.

Poles:

Series 160: 2-, 3- or 4-poles

Series 162, 163 and 165: 1-, 2- or 3-poles

Ratings:

Volts: — 600Vac/dc

Amps: — Up to 1520A

SCCR: — 10kA per UL 508A table SB4.1 (except for select products noted in table)

Agency Information: CE, Guide XCFR2, UL E62622 General Industrial Class per UL 1059; CSA Class 6228-01, File 53787.

Flammability Rating: UL 94V0.

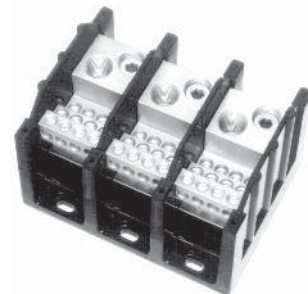

Power Distribution & Terminal Blocks

Catalog Numbers

Catalog Numbers	Line Connection	Load Connection	Connector Material & Ampacity	Agency Information
16021*	2/0-#14Cu, 2/0-#8Al	(6)#4-#14Cu, #4-#8Al	175A	UL/CSA
16023*	350kcmil-#6Cu/Al	(6)#4-#14Cu, #4-#12Al	310A	UL/CSA
16220**	2/0-#14Cu, 2/0-#8Al	(4)#4-#14Cu, #4-#8Al	175A	UL/CSA
16321**	2/0-#14Cu, 2/0-#8Al	(6)#4-#14Cu, #4-#8Al	175A	UL/CSA
16323**	350kcmil-#6Cu/Al	(6)#4-#14Cu, #4-#12Al	310A	UL/CSA
16325	(2)2/0-#14Cu, 2/0-#8Al	(6)#4-#14Cu, #4-#8Al	350A	UL/CSA
16330	500kcmil-#6Cu/Al	(6)#2-#14Cu, #2-#12Al	380A	UL/CSA
16332	350kcmil-#6Cu/Al	(3)#2-#14Cu, #2-#8Al	310A	UL/CSA
16335	500kcmil-#6Cu/Al	(2)1/0-#14Cu, 1/0-#8Al	380A	UL/CSA
16370**	350kcmil-#6Cu/Al	(12)#4-#14Cu, #4-#12Al	310A	UL/CSA
16371**	350kcmil-#6Cu/Al	(6)#2-#14Cu, #2-#8Al	310A	UL/CSA
16372	350kcmil-#6Cu/Al	(3)1/0-#14Cu, 1/0-#8Al	310A	UL/CSA
16373	350kcmil-#6Cu/Al	(21)#10-#14Cu, #10Al	310A	UL/CSA
16375	600kcmil-#2Cu/Al	(14)#10-#14Cu, #10Al	310A	UL/CSA
16376	600kcmil-#2Cu/Al	(12)#4-#14Cu, #4-#12Al	420A	UL/CSA
16377	600kcmil-#2Cu/Al	(6)#2-#14Cu, #2-#8Al	420A	UL/CSA
16378	600kcmil-#2Cu/Al	(3)1/0-#14Cu, 1/0-#8Al	420A	UL/CSA
16379	600kcmil-#2Cu/Al	(3)1/0-#14Cu, 1/0-#8Al	420A	UL/CSA
16377	(2)300kcmil-#4Cu/Al	(12)#4-#14Cu, #4-#12Al	570A	UL/CSA
16400	(4)500kcmil-#6Cu/Al	(22)#2-#14Cu/Al	1520A	UL/CSA
16528	(2)600kcmil-#2Cu/Al	(4)3/0-#6Cu/Al	840A	UL/CSA
16529	(2)600kcmil-#2Cu/Al	(4)#4-#14Cu/Al	840A	UL/CSA
16530	(2)500kcmil-#6Cu/Al	(12)#4-#14Cu/Al	760A	UL/CSA
16541	(1)500kcmil-#6Cu/Al	(21)#6-#14Cu/Al	380A	UL/CSA

*160 Series Bases have mounting holes outside the barriers. Other bases (162 through 165) have mounting holes within barriers. See Data Sheet for dimensional drawings.
**SCCR up to 200kA

How To Order

Catalog Number + # of Poles

Example: 16021 – 3 (complete part number)

Optional Covers:

160 Series: CPB160 - (pole)

162 Series: CPB162 - (pole)

163 Series: CPDB- (pole)

165 Series: CPDB165 (1 for each pole)

Data Sheets: 1117 (Series 160, 162, 165); 1148 (Series 163)

Power Terminal Blocks: Stud & Splicer

Series 162, 163 & 165

Specifications

Description: Power stud terminal blocks.

Construction: Molded black thermoplastic.

Poles: 1-, 2- or 3-poles.

Wire Range: See Catalog Numbers table.

Ratings:

Volts: — 600Vac/dc
Amps: — Up to 760A
SCCR: — 10kA per UL 508A table SB4.1 (except where noted)

Agency Information: CE, Guide XCFR2, UL E62622 General Industrial Class per UL 1059; CSA Class 6228-01, File 53787.

Flammability Rating: UL 94V0.

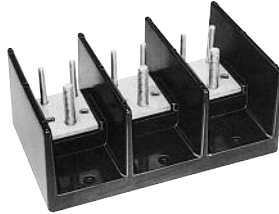

Series 160, 162, 163 & 165

Specifications

Description: Power splicer terminal blocks.

Construction: Molded black thermoplastic.

Wire Range: See Catalog Numbers table.

Poles: Series 160: 2-, 3- or 4-poles

Series 162, 163 and 165: 1-, 2- or 3-poles

Ratings:

Volts: — 600Vac/dc
Amps: — Up to 760A
SCCR: — 10kA per UL 508A table SB4.1 (except for select products noted in table)

Agency Information: CE, Guide XCFR2, UL E62622 General Industrial Class per UL 1059; CSA Class 6228-01, File 53787.

Flammability Rating: UL 94V0.

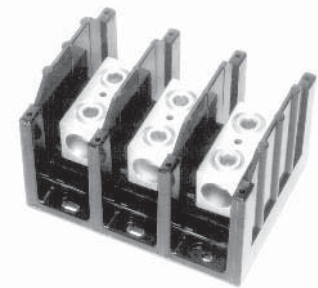

Stud Block Catalog Numbers

Catalog Numbers	Line Connection (Poles)	Load Connection (Poles)	Material & Ampacity	Connector Agency Information
Connector to Stud				
16280*	2/0-#14Cu-Al	1/2-20 X 3/8 Stud	Al-175A	UL —
16281	2/0-#14Cu-Al	1/2-20 Tapped hole	Al-175A	UL —
16378	500kcmil-#6Cu-Al	(2)1/2-20 x 1 Stud	Al-380A	UL CSA
16383	500kcmil-#6Cu-Al	(1)1/2-16 x 1 Stud	Al-380A	UL CSA
16582	(2)500kcmil-#6Cu-Al	(2)1/2-16 x 1 1/8 Stud	Al-760A	UL CSA
Stud to Stud				
16290	1/2-20 x 3/8 Stud	1/2-20 x 3/8 Stud	Cu-175A	UL —
16390	3/8-16 x 1 1/8 Stud	3/8-16 x 1 1/8 Stud	Cu-250A	UL CSA
16394	1/2-13 x 1 1/8 Stud	1/2-13 x 1 1/8 Stud	Cu-400A	UL CSA
16395	3/8-16 x 1 1/8 Stud	(2)1/2-20 x 3/8 Stud	Cu-310A	UL CSA
16591	3/8-16 x 1 1/8 Stud	(2)1/2-16 x 1 1/8 Stud	Cu-400A	UL CSA
16593**	1/2-13 X 1 Stud	1/2-13 X 1 Stud	Cu-600A	UL CSA

Nuts are not supplied with blocks

*SCCR up to 200kA

** 1-Pole not available

How To Order

Catalog Number + # of Poles

Example: 16000 – 3 (complete part number)

Optional Covers:

160 Series: CPB160 - (pole)
162 Series: CPB162 - (pole)
163 Series: CPDB - (pole)
165 Series: CPDB165 (1 for each pole) - new style
CPB165 - (pole) - old style

For Short-circuit current rated stud power distribution blocks, go to the Series PDB and Series 162 & 163 with high SCCR.

Catalog Numbers

Catalog Numbers	Line Connection	Load Connection	Material & Ampacity	Agency Information
16000*	2/0-#8Cu/Al	2/0-#8Cu/Al	Al-175A	UL
16003*	250kcmil-#6Cu Only	250kcmil-#6Cu Only	Cu-255A	UL
16005*	350kcmil-#6Cu/Al	350kcmil-#6Cu/Al	Al-310A	UL
16200	#2-#14Cu, #2-#8Al	#2-#14Cu, #2-#8Al	Al-115A	UL
16201	1/0-#14Cu Only	1/0-#14Cu Only	Cu-150A	UL
16204**	2/0-#8Cu/Al	2/0-#8Cu/Al	Al-175A	UL
16301	250kcmil-#6Cu Only	250kcmil-#6Cu Only	Cu-255A	UL/CSA
16303	350kcmil-#6Cu/Al	350kcmil-#6Cu/Al	Al-310A	UL/CSA
16306	500kcmil-#6Cu/Al	500kcmil-#6Cu/Al	Al-380A	UL/CSA
16500	(2)350kcmil-#4Cu/Al	(2)350kcmil-#4Cu/Al	Al-620A	UL/CSA
16504	(2)500kcmil-#6Cu/Al	(2)500kcmil-#6Cu/Al	Al-760A	UL/CSA

*160 Series Bases have mounting holes outside the barriers. Other bases (162 through 165) have mounting holes within barriers. See Data Sheet for dimensional drawings.

**SCCR up to 200kA

How To Order

Catalog Number + # of Poles

Example: 16000 – 3 (complete part number)

Optional Covers:

160 Series: CPB160 - (pole)
162 Series: CPB162 - (pole)
163 Series: CPDB - (pole)
165 Series: CPDB165 (1 for each pole) - new style
CPB165 - (pole) - old style

For Short-circuit current rated and/or finger-safe splicer blocks, go to the Series PDBFS, Series PDB or Series 162 & 163 with high SCCR.

Power Terminal Blocks: Barrier & Dead Front

Power Distribution
& Terminal Blocks

Series 14002

Specifications

Description: Barrier terminal block.

Poles: 2- to 6-poles.

Wire Range: 2 – 14 AWG Cu/8 AWG Al.

Ratings:

Volts: — 600Vac/dc

Amps: — 115A

SCCR: — 10kA per
UL 508A table SB4.1

Agency Information: CE, Guide XCFR2, UL E62622; CSA 47235.

Torque Ratings*: 2-3, 50 lb-in; 4-6, 45 lb-in; 8, 40 lb-in; 10-14, 35 lb-in.

*Consult factory for torque ratings for CP and Q options.

Marking: Marking strip optional, consult factory.

Options For Load Side Connector

CP: Sems pressure plate, rated 60A, 600V

Q: Quick-Connect, rated 50A, 600V

To order options, enter letter code in front of Catalog Number: i.e., CP14002-2.



Catalog Numbers

Catalog Numbers	Poles	Catalog Numbers	Poles
14002-2	2	14002-5	5
14002-3	3	14002-6	6
14002-4	4		

Series 14004

Specifications

Description: Dead front terminal block.

Poles: 2- to 12-poles.

Wire Range:
4 – 14 AWG Cu/
8 AWG Al.

Ratings:

Volts: — 600Vac/dc

Amps: — 90A

SCCR: — 10kA per UL 508A table SB4.1

Agency Information: CE, Guide XCFR2, UL E62622; CSA 47235.

Marking: Marking strip optional, consult factory.



Catalog Numbers

Catalog Numbers	Poles	Catalog Numbers	Poles
14004-2	2	14004-8	8
14004-3	3	14004-9	9
14004-4	4	14004-10	10
14004-5	5	14004-11	11
14004-6	6	14004-12	12
14004-7	7		

DIN-Rail terminal blocks

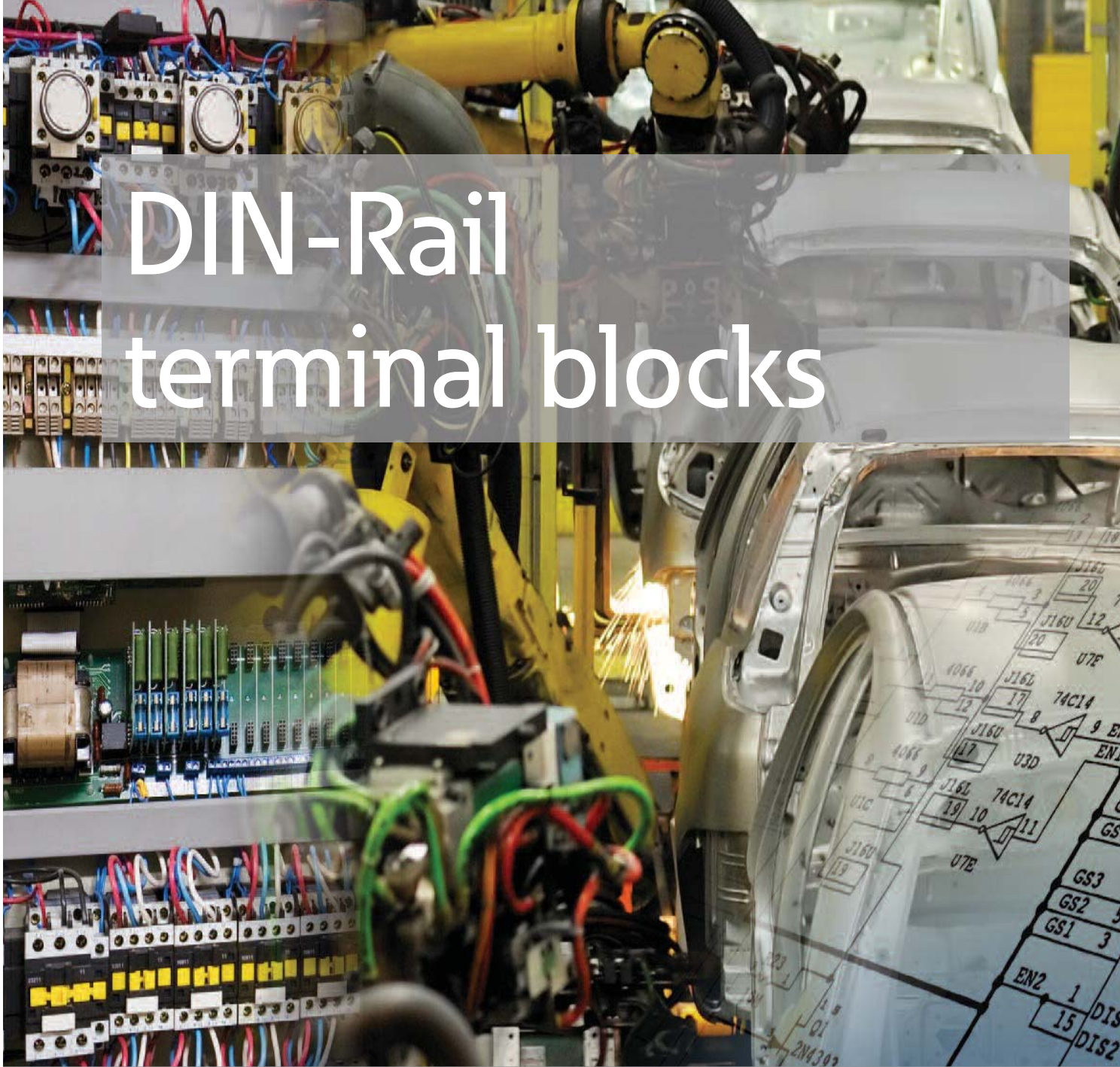

Ratings up to 200kA SCCR
feature multiple bridging options
for point of use configuration

Bussmann
by **EATON**



Scan this tag to get the latest product information for the New Family of Terminal blocks and Accessories.

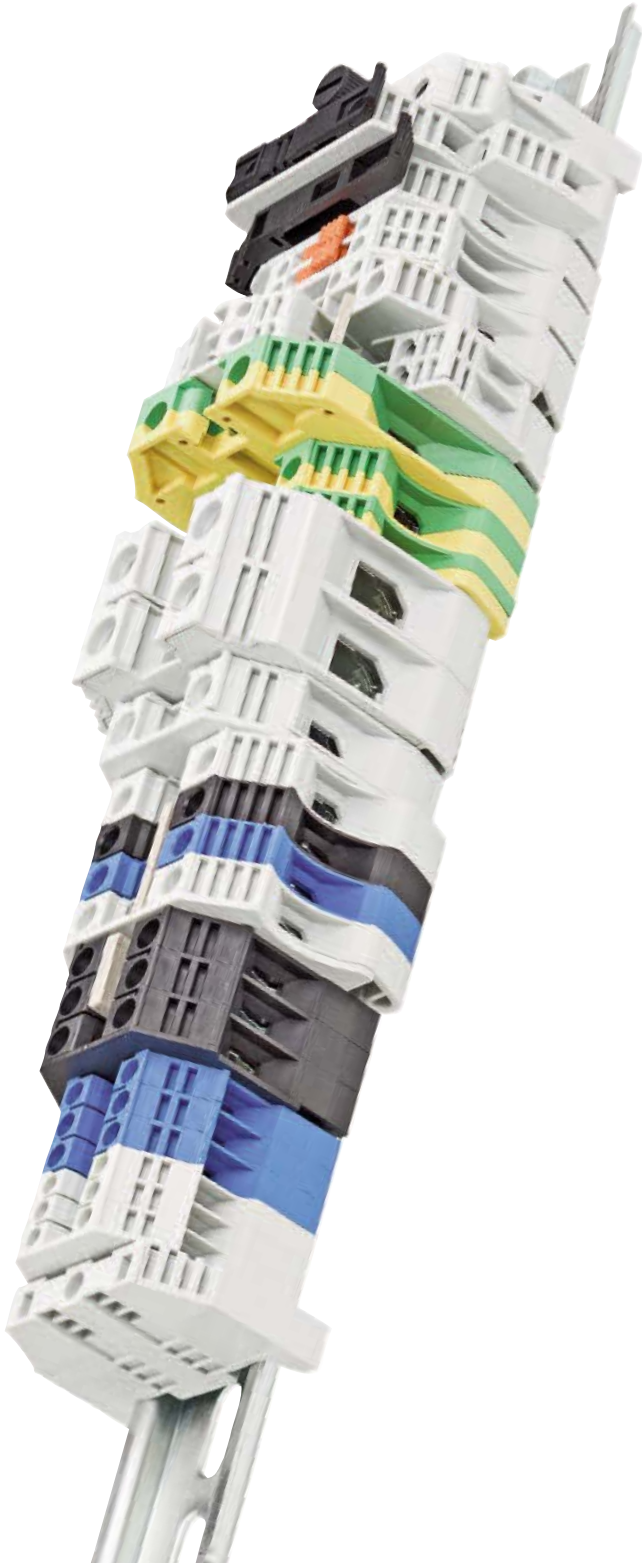

Connectors

Section Contents

Page

DIN-Rail Terminal Blocks

Feed through blocks (DS series)	334
Feed through blocks (DP series)	335-336
Mini feed through blocks (DM series)	337
Double level blocks (DDP series)	338
Disconnect blocks (DG series)	339-340
Fuse holder blocks (F520 series)	341-342
Internally jumpered blocks (DDNS series)	343
Test blocks (DTST2 series)	343
Panel mount blocks	344-345
Short-Circuit Current Ratings (SCCRs)	346-347

Accessories

Top screw-on bridges	348
End brackets	349
Partition plates	349
Jumper slides	350
Top insertion bridges	350
Side insertion bridges	351-352
Mounting rails and brackets	353

BussScribe Marking System

Marking system	354
Marking labels	355-357

Compact Blocks

Feed through blocks (NDN series)	358-359
Feed through blocks (C-Rail series)	360-361
Depluggable blocks	362-363
Multi-pole panel mount blocks	364
Quick connect blocks	365

Double row terminal blocks

Series TB100 2- to 36-Pole blocks	366-367
Series TB200 & TB200HB 2- to 30-Pole blocks	368-369
Series TB300 & TB345 2- to 24-Pole blocks	370-371
<i>Marking options and covers for double row series</i>	372
<i>Top & bottom marking strips for terminal blocks</i>	373
Series TB400 2- to 12-Pole blocks	374
Series KU 2- to 12-Pole Panel mount blocks	375

Power feed through terminal blocks

Series C7021 1- to 6-Pole block	376
Series C7024 1- to 12-Pole block	377

RED indicates **NEW** information



Scan this tag to get access to the Terminal Blocks Cross Reference Search.

Feed Through Blocks

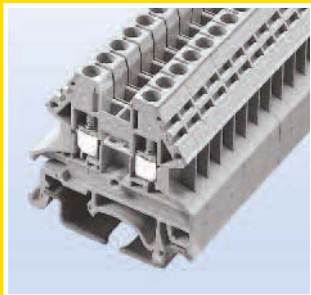

DS Series

The DS Series features a compact design that saves wiring space on the control panel. Accessories include marking labels, partition plates as well as side and top insertion bridges. Designed for 35mm DIN and 32mm G-Type rails.

IEC60947-7-1 & UL 1059 compliant.

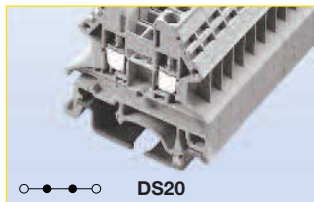

Approval		
Technical Data	UL	IEC
Rated voltage	600V	1000V
Rated current	20A	24A
Conductor cross section, flexible(AWG/mm ²)	22~12 / 0.5~2.5	
Conductor cross section, flexible(AWG/mm ²)	22~12 / 0.5~2.5	
Rated impulse withstand voltage	6kV	
Torque(N•m)	0.4	
Torque(lb-in)	3.5	
Screw	M2.5	
Wire strip length(mm)	9~11	
WxHxD(mm)	5.1 x 39.6 x 40.5	

Colors	Cat. No.
● Grey	DS20-GY
● Blue	DS20-BU
● Black	DS20-LK
● Red	DS20-RD
● Orange	DS20-OR
● Yellow	DS20-YW
● Green	DS20-GN

Accessories	Cat. No.
● Grey	DS20-GY-ND
● Blue	DS20-BU-ND
● Black	DS20-LK-ND
● Red	DS20-RD-ND
● Orange	DS20-OR-ND
● Yellow	DS20-YW-ND
● Green	DS20-GN-ND

Accessories	Cat. No.
	DKNSPS-001
2-pole	DSS2-5N-02P
3-pole	DSS2-5N-03P
4-pole	DSS2-5N-04P
10-pole	DSS2-5N-10P
2-pole	CSC-2-502PN
3-pole	CSC-2-503PN
4-pole	CSC-2-504PN
10-pole	CSC-2-510PN

2-pole	N/A
3-pole	N/A
4-pole	N/A
10-pole	N/A

	TM26CB
	DRL32MMG
	DRL35MMHI
	DRL35MMLO

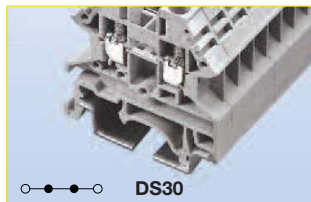

Approval		
Technical Data	UL	IEC
Rated voltage	600V	1000V
Rated current	30A	32A
Conductor cross section, flexible(AWG/mm ²)	22~10 / 0.5~4	
Conductor cross section, flexible(AWG/mm ²)	22~10 / 0.5~4	
Rated impulse withstand voltage	6kV	
Torque(N•m)	0.6	
Torque(lb-in)	5.3	
Screw	M3	
Wire strip length(mm)	9~11	
WxHxD(mm)	6.1 x 39.6 x 40.3	

Colors	Cat. No.
● Grey	DS30-GY
● Blue	DS30-BU
● Black	DS30-LK
● Red	DS30-RD
● Orange	DS30-OR
● Yellow	DS30-YW
● Green	DS30-GN

Accessories	Cat. No.
● Grey	DS20-GY-ND
● Blue	DS20-BU-ND
● Black	DS20-LK-ND
● Red	DS20-RD-ND
● Orange	DS20-OR-ND
● Yellow	DS20-YW-ND
● Green	DS20-GN-ND

Accessories	Cat. No.
	DKNSPS-001
2-pole	DSS4N-02P
3-pole	DSS4N-03P
4-pole	DSS4N-04P
10-pole	DSS4N-10P
2-pole	CSC-402PN
3-pole	CSC-403PN
4-pole	CSC-404PN
10-pole	CSC-410PN

2-pole	N/A
3-pole	N/A
4-pole	N/A
10-pole	N/A

	TM27CB
	DRL32MMG
	DRL35MMHI
	DRL35MMLO

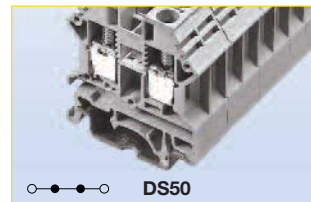

Approval		
Technical Data	UL	IEC
Rated voltage	600V	1000V
Rated current	50A	41A
Conductor cross section, flexible(AWG/mm ²)	22~10 / 0.5~4	
Conductor cross section, flexible(AWG/mm ²)	20~8 / 0.5~6	
Rated impulse withstand voltage	8kV	
Torque(N•m)	1.2	
Torque(lb-in)	10.6	
Screw	M4	
Wire strip length(mm)	12~14	
WxHxD(mm)	8 x 45 x 41.7	

Colors	Cat. No.
● Grey	DS50-GY
● Blue	DS50-BU
● Black	DS50-LK
● Red	DS50-RD
● Orange	DS50-OR
● Yellow	DS50-YW
● Green	DS50-GN

Accessories	Cat. No.
● Grey	DS50-GY-ND
● Blue	DS50-BU-ND
● Black	DS50-LK-ND
● Red	DS50-RD-ND
● Orange	DS50-OR-ND
● Yellow	DS50-YW-ND
● Green	DS50-GN-ND

Accessories	Cat. No.
	DKNSPS-002
2-pole	DSS6N-02P
3-pole	DSS6N-03P
4-pole	DSS6N-04P
10-pole	DSS6N-10P
2-pole	CSC-602PN
3-pole	CSC-603PN
4-pole	CSC-604PN
10-pole	CSC-610PN

2-pole	N/A
3-pole	N/A
4-pole	N/A
10-pole	N/A

	TM28CB
	DRL32MMG
	DRL35MMHI
	DRL35MMLO



Block



End cover



Small partition



Top Insertion bridge



Side Insertion bridge



Top Screw-on bridge



Marking label



Mounting Rail



Tool



Feed Through Blocks

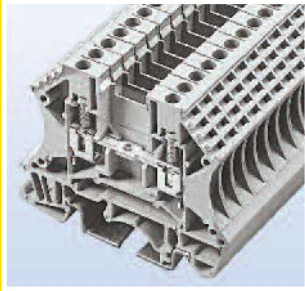

DP Series

The DP Series features a generous design allowing for more wiring space and access. Additionally, this series features a larger wire contact area and larger conducting elements. Accessories include marking labels, partition plates, side insertion bridge and top screw-on bridge for improved reliability. Comes with matching shaped grounding blocks. Designed for 35mm DIN and 32mm G-Type rails.

IEC60947-7 and UL1059 compliant.

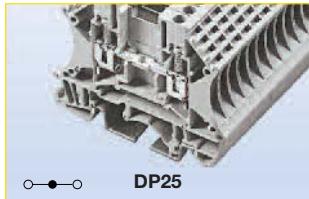

Approval		
Technical Data	UL	IEC
Rated voltage	600V	630V
Rated current	25A	24A
Conductor cross section, flexible(AWG/mm ²)	22-12 / 0.5-2.5	
Conductor cross section, flexible(AWG/mm ²)	22-12 / 0.5-2.5	
Rated impulse withstand voltage	8kV	
Torque(N•m)	0.8	
Torque(lb-in)	7.1	
Screw	M3	
Wire strip length(mm)	10-12	
WxHxD(mm)	5.1 x 47.6 x 58.9	

Colors	Cat. No.
● Grey	DP25-GY
● Blue	DP25-BU
● Black	DP25-LK
● Red	DP25-RD
● Orange	DP25-OR
● Yellow	DP25-YW
● Green	DP25-GN

Accessories	Cat. No.
● Grey	DP25-GY-ND
● Blue	DP25-BU-ND
● Black	DP25-LK-ND
● Red	DP25-RD-ND
● Orange	DP25-OR-ND
● Yellow	DP25-YW-ND
● Green	DP25-GN-ND

	Cat. No.
	DKSPS-001
	DKSPS-002

	Cat. No.
2-pole	N/A
3-pole	N/A
4-pole	N/A
10-pole	N/A

	Cat. No.
2-pole	CSC-2-502P
3-pole	CSC-2-503P
4-pole	CSC-2-504P
10-pole	CSC-2-510P

	Cat. No.
2-pole	DS2-5-02P
3-pole	DS2-5-03P
4-pole	DS2-5-04P
10-pole	DS2-5-10P

	Cat. No.
	TM26CB
	DRL32MMG
	DRL35MMHI
	DRL35MMLLO

Tool	
	0.4 x 2.5mm

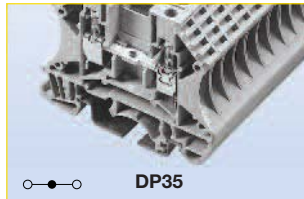

Approval		
Technical Data	UL	IEC
Rated voltage	600V	630V
Rated current	35A	32A
Conductor cross section, flexible(AWG/mm ²)	22-10 / 0.5-4	
Conductor cross section, flexible(AWG/mm ²)	22-10 / 0.5-4	
Rated impulse withstand voltage	8kV	
Torque(N•m)	0.8	
Torque(lb-in)	7.1	
Screw	M3	
Wire strip length(mm)	10-12	
WxHxD(mm)	6.1 x 47.6 x 58.9	

Colors	Cat. No.
● Grey	DP35-GY
● Blue	DP35-BU
● Black	DP35-LK
● Red	DP35-RD
● Orange	DP35-OR
● Yellow	DP35-YW
● Green	DP35-GN

Accessories	Cat. No.
● Grey	DP25-GY-ND
● Blue	DP25-BU-ND
● Black	DP25-LK-ND
● Red	DP25-RD-ND
● Orange	DP25-OR-ND
● Yellow	DP25-YW-ND
● Green	DP25-GN-ND

	Cat. No.
	DKSPS-001
	DKSPS-002

	Cat. No.
2-pole	N/A
3-pole	N/A
4-pole	N/A
10-pole	N/A

	Cat. No.
2-pole	CSC-402P
3-pole	CSC-303P
4-pole	CSC-404P
10-pole	CSC-410P

	Cat. No.
2-pole	DS4-02P
3-pole	DS4-03P
4-pole	DS4-04P
10-pole	DS4-10P

	Cat. No.
	TM27CB
	DRL32MMG
	DRL35MMHI
	DRL35MMLLO

Tool	
	0.5 x 3mm

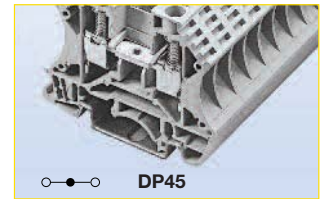

Approval		
Technical Data	UL	IEC
Rated voltage	600V	500V
Rated current	45A	41A
Conductor cross section, flexible(AWG/mm ²)	20-8 / 0.5-6	
Conductor cross section, flexible(AWG/mm ²)	20-8 / 0.5-6	
Rated impulse withstand voltage	8kV	
Torque(N•m)	1.8	
Torque(lb-in)	15.9	
Screw	M4	
Wire strip length(mm)	12-14	
WxHxD(mm)	8 x 47.6 x 58.9	

Colors	Cat. No.
● Grey	DP45-GY
● Blue	DP45-BU
● Black	DP45-LK
● Red	DP45-RD
● Orange	DP45-OR
● Yellow	DP45-YW
● Green	DP45-GN

Accessories	Cat. No.
● Grey	DP25-GY-ND
● Blue	DP25-BU-ND
● Black	DP25-LK-ND
● Red	DP25-RD-ND
● Orange	DP25-OR-ND
● Yellow	DP25-YW-ND
● Green	DP25-GN-ND

	Cat. No.
	DKSPS-001
	DKSPS-002

	Cat. No.
2-pole	N/A
3-pole	N/A
4-pole	N/A
10-pole	N/A

	Cat. No.
2-pole	CSC-602P
3-pole	CSC-603P
4-pole	CSC-604P
10-pole	CSC-610P

	Cat. No.
2-pole	DS6-02P
3-pole	DS6-03P
4-pole	DS6-04P
10-pole	DS6-10P

	Cat. No.
	TM28CB
	DRL32MMG
	DRL35MMHI
	DRL35MMLLO

Tool	
	0.8 x 4mm

Block



End cover



Partition



Small partition



Top Insertion bridge



Side Insertion bridge



Top Screw-on bridge



Marking label



Mounting Rail



Tool



Feed Through Blocks

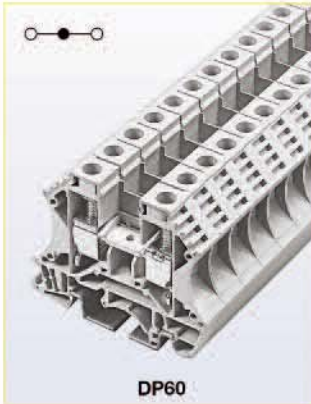

DP60

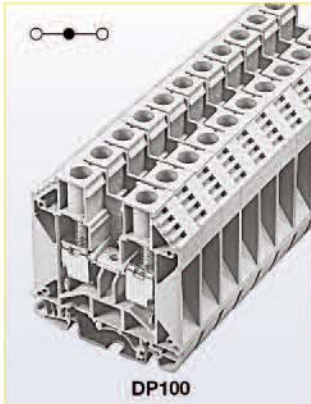

DP100



DP150



DP230

Approval	cULus	
----------	-------	--

Technical Data	UL	IEC
Rated voltage	600V	500V
Rated current	60A	57A
Conductor cross-section, solid (AWG/mm ²)	20-6 / 1.5-10	
Conductor cross-section, flexible (AWG/mm ²)	20-6 / 1.5-10	
Rated impulse withstand voltage	8kV	
Torque(N•m)	1.8	
Torque(lb-in)	15.9	
Screw	M4	
Wire strip length(mm)	12-14	
WxHxD(mm)	10 x 47.6 x 58.9	

Colors	Cat. No.
● Grey	DP60-GY

Accessories	Cat. No.
● Grey	DP25-GY-ND

DKSPS-001	
DKSPS-002	

2-pole	N/A
3-pole	N/A
4-pole	N/A
10-pole	N/A
2-pole	CSC-1002P
3-pole	CSC-1003P
4-pole	CSC-1004P
10-pole	CSC-1010P
2-pole	DS10-02P
3-pole	DS10-03P
4-pole	DS10-04P
10-pole	DS10-10P

TM28CB	
DRL32MMG	
DRL35MMHI	
DRL35MML0	
0.8 x 4mm	

Approval	cULus	
----------	-------	--

Technical Data	UL	IEC
Rated voltage	600V	1000V
Rated current	100A	101A
Conductor cross-section, solid (AWG/mm ²)	14-3 / 1.5-25	
Conductor cross-section, flexible (AWG/mm ²)	14-3 / 1.5-25	
Rated impulse withstand voltage	8kV	
Torque(N•m)	3.4	
Torque(lb-in)	30.1	
Screw	M5	
Wire strip length(mm)	13-15	
WxHxD(mm)	12 x 52.2 x 46.7	

Colors	Cat. No.
● Grey	DP100-GY

Accessories	Cat. No.
● Grey	DP100-GY-ND

DKNSPS-003	
------------	--

2-pole	N/A
3-pole	N/A
4-pole	N/A
10-pole	N/A
2-pole	CSC-1602P
3-pole	CSC-1603P
4-pole	CSC-1604P
10-pole	CSC-1610P
2-pole	DS16-02P
3-pole	DS16-03P
4-pole	DS16-04P
10-pole	DS16-10P

TM28CB	
DRL32MMG	
DRL35MMHI	
DRL35MML0	
1.0 x 5.5mm	

Approval	cULus	
----------	-------	--

Technical Data	UL	IEC
Rated voltage	600V	1000V
Rated current	150A	150A
Conductor cross-section, solid (AWG/mm ²)	12-1/0 / 2.5-50	
Conductor cross-section, flexible (AWG/mm ²)	12-1/0 / 2.5-50	
Rated impulse withstand voltage	8kV	
Torque(N•m)	6.9	
Torque(lb-in)	61.1	
Screw	M6	
Wire strip length(mm)	16-18	
WxHxD(mm)	16 x 61.2 x 52	

Colors	Cat. No.
● Grey	DP150-GY
● Blue	DP150-BU

Accessories	Cat. No.
-------------	----------

DKNSPS-004	
------------	--

2-pole	N/A
3-pole	N/A
4-pole	N/A
10-pole	N/A
2-pole	CSC-3502P
3-pole	CSC-3503P
4-pole	CSC-3504P
10-pole	CSC-3510P
2-pole	DS35-02P
3-pole	DS35-03P
4-pole	DS35-04P
10-pole	DS35-10P

TM28CB	
DRL32MMG	
DRL35MMHI	
DRL35MML0	

Approval	cULus	
----------	-------	--

Technical Data	UL	IEC
Rated voltage	600V	1000V
Rated current	230A	232A
Conductor cross-section, solid (AWG/mm ²)	2 / 35	
Conductor cross-section, flexible (AWG/mm ²)	2-4/0 / 35-95	
Rated impulse withstand voltage	8kV	
Torque(N•m)	10.2	
Torque(lb-in)	90.3	
Screw	M8	
Wire strip length(mm)	30-35	
WxHxD(mm)	25 x 88.5 x 80	

Colors	Cat. No.
● Grey	DP230-GY
● Blue	DP230-BU

Accessories	Cat. No.
-------------	----------

DKNSPS-004	
------------	--

2-pole	N/A
3-pole	N/A
4-pole	N/A
10-pole	N/A
2-pole	CSC-9502P
3-pole	CSC-9503P
4-pole	N/A
10-pole	N/A
2-pole	N/A
3-pole	N/A
4-pole	N/A
10-pole	N/A

TM28CB	
DRL32MMG	
DRL35MMHI	
DRL35MML0	

Mini Feed Through Blocks



DM Series

The DM Series is our low cost, miniature feed through terminal block design for 15mm DIN-Rail. Accessories include side insertion bridge and marking labels.

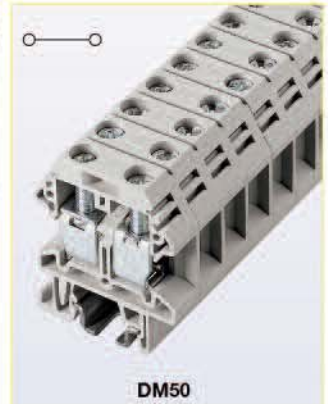
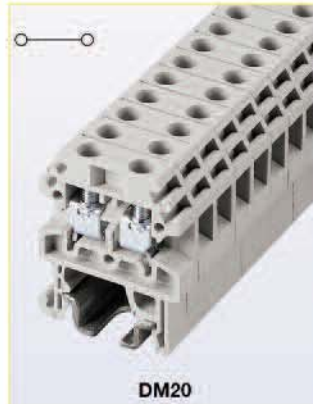

Approval		
Technical Data		
Rated voltage	300V	500V
Rated current	20A	24A
Conductor cross-section, solid (AWG/mm ²)	22-12 / 0.5-2.5	
Conductor cross-section, flexible (AWG/mm ²)	22-12 / 0.5-2.5	
Rated impulse withstand voltage	5kV	
Torque(N•m)	0.4	
Torque(lb-in)	3.5	
Screw	M2.5	
Wire strip length(mm)	7-9	
WxHxD(mm)	5.1 x 28 x 22	

Approval		
Technical Data		
Rated voltage	300V	500V
Rated current	30A	32A
Conductor cross-section, solid (AWG/mm ²)	22-10 / 0.5-4	
Conductor cross-section, flexible (AWG/mm ²)	22-10 / 0.5-4	
Rated impulse withstand voltage	5kV	
Torque(N•m)	0.6	
Torque(lb-in)	5.3	
Screw	M3	
Wire strip length(mm)	7-9	
WxHxD(mm)	6.1 x 31.5 x 22	

Approval		
Technical Data		
Rated voltage	300V	500V
Rated current	50A	41A
Conductor cross-section, solid (AWG/mm ²)	20-8 / 0.5-6	
Conductor cross-section, flexible (AWG/mm ²)	20-8 / 0.5-6	
Rated impulse withstand voltage	6kV	
Torque(N•m)	1.2	
Torque(lb-in)	10.6	
Screw	M4	
Wire strip length(mm)	9-11	
WxHxD(mm)	8 x 37.4 x 30	

Colors	Cat. No.
● Grey	DM20-GY
● Blue	DM20-BU
● Black	DM20-LK

Colors	Cat. No.
● Grey	DM30-GY
● Blue	DM30-BU
● Black	DM30-LK

Colors	Cat. No.
● Grey	DM50-GY
● Blue	DM50-BU
● Black	DM50-LK

Accessories	Cat. No.
● Grey	DM20-GY-ND
● Blue	DM20-BU-ND
● Black	DM20-LK-ND

Accessories	Cat. No.
● Grey	DM30-GY-ND
● Blue	DM30-BU-ND
● Black	DM30-LK-ND

Accessories	Cat. No.
● Grey	DM50-GY-ND
● Blue	DM50-BU-ND
● Black	DM50-LK-ND

- Block
- End cover
- Partition
- Small partition
- Top Insertion bridge
- Side Insertion bridge
- Top Screw-on bridge
- Marking label
- Mounting Rail
- Tool

2-pole	N/A
3-pole	N/A
4-pole	N/A
10-pole	N/A
2-pole	CSC-2-502PS
3-pole	CSC-2-503PS
4-pole	CSC-2-504PS
10-pole	CSC-2-510PS
2-pole	N/A
3-pole	N/A
4-pole	N/A
10-pole	N/A
Marking label	TM20CB
Mounting Rail	DRL15MM

2-pole	N/A
3-pole	N/A
4-pole	N/A
10-pole	N/A
2-pole	CSC-402PS
3-pole	CSC-303PS
4-pole	CSC-404PS
10-pole	CSC-410PS
2-pole	N/A
3-pole	N/A
4-pole	N/A
10-pole	N/A
Marking label	TM21CB
Mounting Rail	DRL15MM

2-pole	N/A
3-pole	N/A
4-pole	N/A
10-pole	N/A
2-pole	CSC-602PS
3-pole	CSC-603PS
4-pole	CSC-604PS
10-pole	CSC-610PS
2-pole	N/A
3-pole	N/A
4-pole	N/A
10-pole	N/A
Marking label	TM22CB
Mounting Rail	DRL15MM

Double Level Blocks

Disconnect Blocks

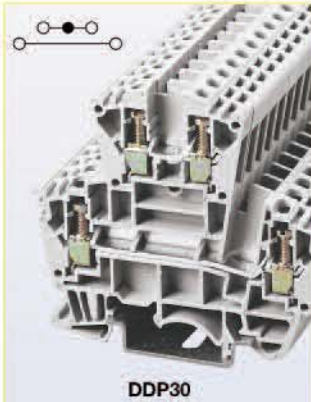

DDP Series

The DDP30 is a two-tier feed through terminal block for space constrained applications. It has two independent circuits, IEC60947-7 and UL1059 compliant. Marking system, side insertion bridge and top screw-on bridge are standard.

Approval			
Technical Data		UL	IEC
Rated voltage		300V	400V
Rated current		30A	32A
Conductor cross-section, solid (AWG/mm ²)		22-10 / 0.5-4	
Conductor cross-section, flexible (AWG/mm ²)		22-10 / 0.5-4	
Rated impulse withstand voltage		6kV	
Torque(N•m)		0.5	
Torque(lb-in)		4.4	
Screw		M2.5	
Wire strip length(mm)		6	
WxHxD(mm)		6.1 x 62.8 x 69.4	

Colors	Cat. No.
● Grey	DDP30-GY

Accessories		Cat. No.
● Grey		DDP30-GY-ND

2-pole		N/A
3-pole		N/A
4-pole		N/A
10-pole		N/A
2-pole		CSC-402P
3-pole		CSC-403P
4-pole		CSC-404P
10-pole		CSC-410P
2-pole		DS4-02P
3-pole		DS4-03P
4-pole		DS4-04P
10-pole		DS4-10P

		TM21CB
		DRL32MMG
		DRL35MMHI
		DRL35MMLO
		0.4 x 2.5mm

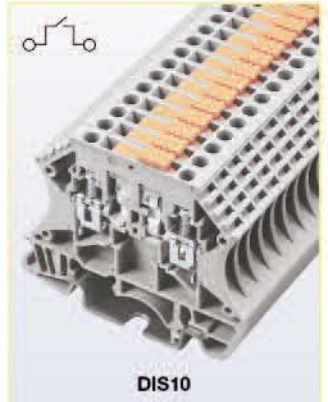
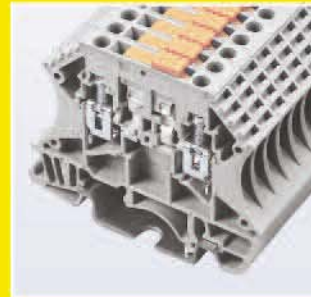

DIS Series

The DIS10 is a disconnect* terminal block. Disconnect terminal blocks offer an easy means of circuit disconnect with just a flick of a screwdriver. IEC60947-7 and UL1059 compliant.

* Not for use as a load break disconnect.

Approval			
Technical Data		UL	IEC
Rated voltage		300V	800V
Rated current		10A	16A
Conductor cross-section, solid (AWG/mm ²)		26-14 / 0.5-2.5	
Conductor cross-section, flexible (AWG/mm ²)		26-14 / 0.5-2.5	
Rated impulse withstand voltage		6kV	
Torque(N•m)		0.8	
Torque(lb-in)		7.1	
Screw		M3	
Wire strip length(mm)		9-10	
WxHxD(mm)		5.1 x 46.7 x 59	

Colors	Cat. No.
● Grey	DIS10-GY

Accessories		Cat. No.
● Grey		DP25-GY-ND

		DKSPS-002
--	--	-----------

2-pole		N/A
3-pole		N/A
4-pole		N/A
10-pole		N/A
2-pole		CSC-2-502P
3-pole		CSC-2-503P
4-pole		CSC-2-504P
10-pole		CSC-2-510P
2-pole		N/A
3-pole		N/A
4-pole		N/A
10-pole		N/A

		TM26CB
		DRL32MMG
		DRL35MMHI
		DRL35MMLO
		0.5 x 3mm

Block

End cover

Partition

Small partition

Top Insertion bridge

Side Insertion bridge

Top Screw-on bridge

Marking label

Mounting Rail

Tool

Block

End cover

Partition

Small partition

Top Insertion bridge

Side Insertion bridge

Top Screw-on bridge

Marking label

Mounting Rail

Tool

Grounding Blocks



DG Series

The DG Series grounding DIN-Rail Terminal blocks fit both standard 35mm DIN-Rail and 32mm G-Type rails. Compliant with IEC60947-7 and UL1059 standards for worldwide acceptance. These have the same general shape as the DP Series.

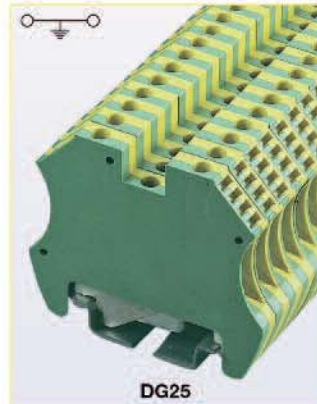

DG25

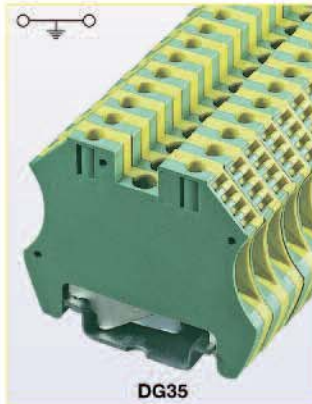

DG35

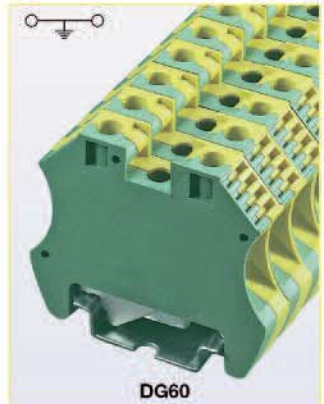

DG60

Approval	cULus	
Technical Data	UL	IEC
Rated voltage	600V	630V
Rated current	24A	
Conductor cross-section, solid (AWG/mm ²)	26-12 / 0.5-2.5	
Conductor cross-section, flexible (AWG/mm ²)	26-12 / 0.5-2.5	
Rated impulse withstand voltage	8kV	
Torque(N•m)	0.8	
Torque(lb-in)	7.1	
Screw	M3	
Wire strip length(mm)	10-14	
WxHxD(mm)	5.7 x 46.4 x 56	

Colors	Cat. No.
● Yellow-Green	DG25-YG

Approval	cULus	
Technical Data	UL	IEC
Rated voltage	600V	630V
Rated current	32A	
Conductor cross-section, solid (AWG/mm ²)	26-10 / 0.5-4	
Conductor cross-section, flexible (AWG/mm ²)	26-10 / 0.5-4	
Rated impulse withstand voltage	8kV	
Torque(N•m)	0.8	
Torque(lb-in)	7.1	
Screw	M3	
Wire strip length(mm)	12-16	
WxHxD(mm)	6.6 x 46.4 x 56	

Colors	Cat. No.
● Yellow-Green	DG35-YG

Approval	cULus	
Technical Data	UL	IEC
Rated voltage	600V	500V
Rated current	57A	
Conductor cross-section, solid (AWG/mm ²)	16-8 / 1.5-10	
Conductor cross-section, flexible (AWG/mm ²)	16-8 / 1.5-10	
Rated impulse withstand voltage	8kV	
Torque(N•m)	1.8	
Torque(lb-in)	15.9	
Screw	M4	
Wire strip length(mm)	12-16	
WxHxD(mm)	10.4 x 46.4 x 56	

Colors	Cat. No.
● Yellow-Green	DG60-YG

Accessories	Cat. No.

Accessories	Cat. No.

Accessories	Cat. No.

2-pole	N/A
3-pole	N/A
4-pole	N/A
10-pole	N/A
2-pole	N/A
3-pole	N/A
4-pole	N/A
10-pole	N/A
2-pole	N/A
3-pole	N/A
4-pole	N/A
10-pole	N/A

2-pole	N/A
3-pole	N/A
4-pole	N/A
10-pole	N/A
2-pole	N/A
3-pole	N/A
4-pole	N/A
10-pole	N/A
2-pole	N/A
3-pole	N/A
4-pole	N/A
10-pole	N/A

2-pole	N/A
3-pole	N/A
4-pole	N/A
10-pole	N/A
2-pole	N/A
3-pole	N/A
4-pole	N/A
10-pole	N/A
2-pole	N/A
3-pole	N/A
4-pole	N/A
10-pole	N/A

- Block
- End cover
- Partition
- Small partition
- Top Insertion bridge
- Side Insertion bridge
- Top Screw-on bridge
- Marking label
- Mounting Rail
- Tool

Marking label	Cat. No.
	TM26CB
	DRL32MMG
	DRL35MMHI
	DRL35MMLLO
	0.5 x 3mm

Marking label	Cat. No.
	TM27CB
	DRL32MMG
	DRL35MMHI
	DRL35MMLLO
	0.5 x 3mm

Marking label	Cat. No.
	TM28CB
	DRL32MMG
	DRL35MMHI
	DRL35MMLLO
	0.8 x 4mm

Grounding Blocks

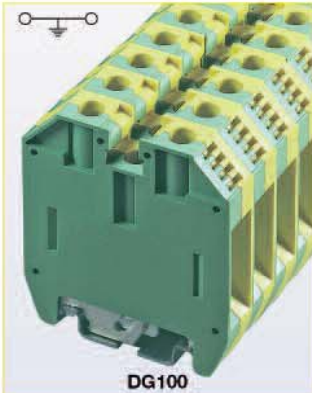

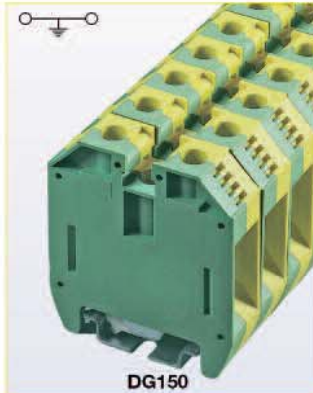

DG100



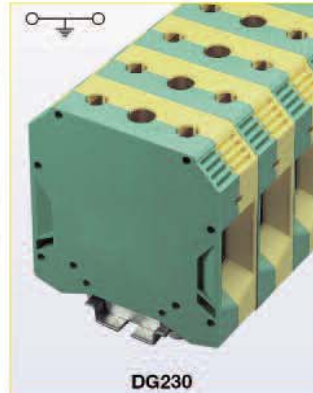



DG150



DG230

Approval  		
Technical Data	UL	IEC
Rated voltage	600V	1000V
Rated current	76A	
Conductor cross-section, solid (AWG/mm ²)	14-6 / 2.5-16	
Conductor cross-section, flexible (AWG/mm ²)	14-6 / 2.5-16	
Rated impulse withstand voltage	8kV	
Torque(N•m)	3.4	
Torque(lb-in)	30.1	
Screw	M5	
Wire strip length(mm)	14-18	
WxHxD(mm)	12 x 62.4 x 56	
Colors	Cat. No.	
 Yellow-Green	DG100-YG	

Approval  		
Technical Data	UL	IEC
Rated voltage	600V	1000V
Rated current	125A	
Conductor cross-section, solid (AWG/mm ²)	12-2 / 4-35	
Conductor cross-section, flexible (AWG/mm ²)	12-2 / 4-35	
Rated impulse withstand voltage	8kV	
Torque(N•m)	5.6	
Torque(lb-in)	49.6	
Screw	M6	
Wire strip length(mm)	14-18	
WxHxD(mm)	16 x 62.4 x 56	
Colors	Cat. No.	
 Yellow-Green	DG150-YG	

Approval  		
Technical Data	UL	IEC
Rated voltage	600V	1000V
Rated current	232A	
Conductor cross-section, solid (AWG/mm ²)	2 / 35	
Conductor cross-section, flexible (AWG/mm ²)	2-4/0 / 35-95	
Rated impulse withstand voltage	8kV	
Torque(N•m)	18	
Torque(lb-in)	159.3	
Screw	M8	
Wire strip length(mm)	20-25	
WxHxD(mm)	25 x 82.93 x 80	
Colors	Cat. No.	
 Yellow-Green	DG230-YG	

Accessories	Cat. No.
2-pole	N/A
3-pole	N/A
4-pole	N/A
10-pole	N/A
2-pole	N/A
3-pole	N/A
4-pole	N/A
10-pole	N/A
2-pole	N/A
3-pole	N/A
4-pole	N/A
10-pole	N/A
	TM28CB
	DRL32MMG DRL35MMHI DRL35MML0
	1.0 x 5.5mm

Accessories	Cat. No.
2-pole	N/A
3-pole	N/A
4-pole	N/A
10-pole	N/A
2-pole	N/A
3-pole	N/A
4-pole	N/A
10-pole	N/A
2-pole	N/A
3-pole	N/A
4-pole	N/A
10-pole	N/A
	TM28CB
	DRL32MMG DRL35MMHI DRL35MML0
	1.0 x 5.5mm

Accessories	Cat. No.
2-pole	N/A
3-pole	N/A
4-pole	N/A
10-pole	N/A
2-pole	N/A
3-pole	N/A
4-pole	N/A
10-pole	N/A
2-pole	N/A
3-pole	N/A
4-pole	N/A
10-pole	N/A
	TM28CB
	DRL32MMG DRL35MMHI DRL35MML0
	1.0 x 5.5mm

Fuse Holder Blocks



F520 Series

Fuse terminal blocks protect your sensors and relays. Available in lever and screw-cap style, with and without LED indication. Uses standard Bussmann 5 x 20 mm fuses.

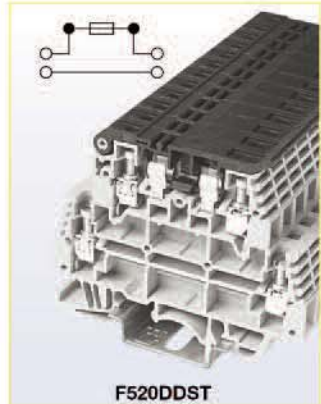
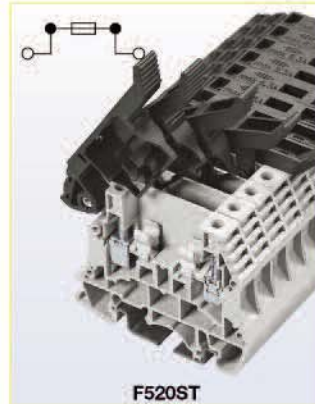

Approval		
Technical Data		UL IEC
Rated voltage	300V	300V
Rated current	6.3A	6.3A
Conductor cross-section, solid (AWG/mm ²)	24-12 / 0.5-4	
Conductor cross-section, flexible (AWG/mm ²)	24-12 / 0.5-4	
Rated impulse withstand voltage	6kV	
Torque(N•m)	0.8	
Torque(lb-in)	7.1	
Screw	M3	
Wire strip length(mm)	10-12	
WxHxD(mm)	8 x 55.7 x 56	

Approval		
Technical Data		UL IEC
Rated voltage	300V	300V
Rated current	6.3A	6.3A
Conductor cross-section, solid (AWG/mm ²)	24-12 / 0.5-4	
Conductor cross-section, flexible (AWG/mm ²)	24-12 / 0.5-4	
Rated impulse withstand voltage	6kV	
Torque(N•m)	0.8	
Torque(lb-in)	7.1	
Screw	M3	
Wire strip length(mm)	10-12	
WxHxD(mm)	8 x 55.7 x 56	

Approval		
Technical Data		UL IEC
Rated voltage	300V ¹⁾	300V
Rated current	16A ²⁾	16A ³⁾
Rated current	30A ²⁾	30A ³⁾
Conductor cross-section, solid (AWG/mm ²)	22-10 / 0.5-4	
Conductor cross-section, flexible (AWG/mm ²)	22-10 / 0.5-4	
Rated impulse withstand voltage	6kV	
Torque(N•m)	0.67	
Torque(lb-in)	5.9	
Screw	M3.5	
Wire strip length(mm)	10-12	
WxHxD(mm)	8 x 60.5 x 72.5	

Colors	Cat. No.
● Grey	F520ST-GY

Colors	Voltage	Cat. No.
● Grey	5V	F520STLED5-GY
● Grey	12V	F520STLED12-GY
● Grey	24V	F520STLED24-GY
● Grey	48V	F520STLED48-GY
● Grey	110V	F520STLED110-GY
● Grey	220V	F520STLED220-GY
● Grey	300V	F520STLED300-GY

Colors	Cat. No.
● Grey	F520DDST-GY

1) UL 600V / 5A
2) upper level 3) lower level

Accessories		Cat. No.
● Grey		F520-GY-ND
2-pole	N/A	
3-pole	N/A	
4-pole	N/A	
10-pole	N/A	
2-pole	CSC-602PN	
3-pole	CSC-603PN	
4-pole	CSC-604PN	
10-pole	CSC-610PN	
2-pole	N/A	
3-pole	N/A	
4-pole	N/A	
10-pole	N/A	
	TM28CB	
	DRL32MMG	
	DRL35MMHI	
	DRL35MMLO	
	0.5 x 3mm	

Accessories		Cat. No.
● Grey End Cover		F520-GY-ND
2-pole	CSC-602PN	
3-pole	CSC-603PN	
4-pole	CSC-604PN	
10-pole	CSC-610PN	
2-pole	N/A	
3-pole	N/A	
4-pole	N/A	
10-pole	N/A	
	TM28CB	
	DRL32MMG	
	DRL35MMHI	
	DRL35MMLO	
	0.5 x 3mm	



Accessories		Cat. No.
● Grey		F520DD-GY-ND
2-pole	N/A	
3-pole	N/A	
4-pole	N/A	
10-pole	N/A	
2-pole	N/A	
3-pole	N/A	
4-pole	N/A	
10-pole	N/A	
	TM28CB	
	DRL32MMG	
	DRL35MMHI	
	DRL35MMLO	
	0.5 x 3mm	

- Block
- End cover
- Partition
- Small partition
- Top Insertion bridge
- Side Insertion bridge
- Top Screw-on bridge
- Marking label
- Mounting Rail
- Tool

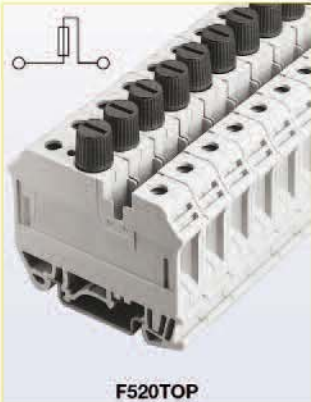
Fuse Holder Blocks



F520TOP

Approval 		
Technical Data	UL	IEC
Rated voltage	600V	660V
Rated current	6.3A	6.3A
Conductor cross-section, solid (AWG/mm ²)	22-6 / 1.5-10	
Conductor cross-section, flexible (AWG/mm ²)	22-6 / 1.5-10	
Rated impulse withstand voltage	6kV	
Torque(N•m)	1.8	
Torque(lb-in)	15.9	
Screw	M4	
Wire strip length(mm)	12-16	
WxHxD(mm)	12 x 47.2 x 61.6	
Colors		Cat. No.
 Grey	F520TOP-GY	

Accessories	Cat. No.

2-pole	N/A
3-pole	N/A
4-pole	N/A
10-pole	N/A
2-pole	N/A
3-pole	N/A
4-pole	N/A
10-pole	N/A
2-pole	N/A
3-pole	N/A
4-pole	N/A
10-pole	N/A
TM20CB	
DRL32MMG	
DRL35MMHI	
DRL35MML0	
0.6 x 3.5mm	



Internally Jumpered Blocks

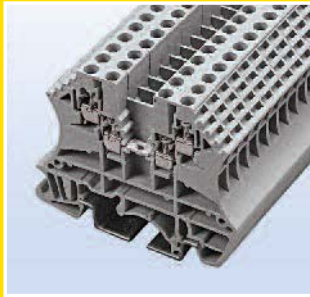

DDNS Series

The DDNS10 is an internally jumpered terminal block. Internally jumpered double-level terminal blocks provide high-density power distribution in 3-in/1-out or 2-in/2-out or 1-in/3-out options with a single block. Add top and side insertion bridges to achieve any connection topology. IEC60947-7 and UL1059 compliant.

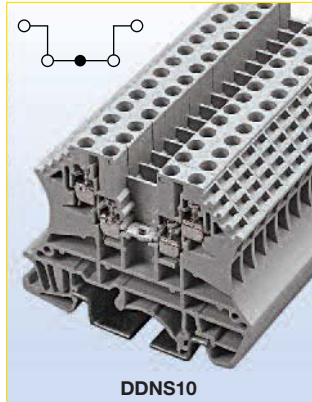

DDNS10

Approval		
Technical Data		
Rated voltage	300V	630V
Rated current	10A	17.5A
Conductor cross-section, solid (AWG/mm ²)	22-14 / 0.5-1.5	
Conductor cross-section, flexible (AWG/mm ²)	22-14 / 0.5-1.5	
Rated impulse withstand voltage	8kV	
Torque(N•m)	0.4	
Torque(lb-in)	3.5	
Screw	M2.5	
Wire strip length(mm)	6~7	
WxHxD(mm)	5.1 x 46.8 x 58.9	
Colors	Cat. No.	
● Grey	DDNS10-GY	

Accessories		
Cat. No.		
● Grey	DDNS10-GY-ND	
2-pole	N/A	
3-pole	N/A	
4-pole	N/A	
10-pole	N/A	
2-pole	CSC-2-502P	
3-pole	CSC-2-503P	
4-pole	CSC-2-504P	
10-pole	CSC-2-510P	
2-pole	DS2-5-02P	
3-pole	DS2-5-03P	
4-pole	DS2-5-04P	
10-pole	DS2-5-10P	
Marking label	TM26CB	
Mounting Rail	DRL32MMG DRL35MMHI DRL35MMLD	
Tool	0.4 x 2.5mm	

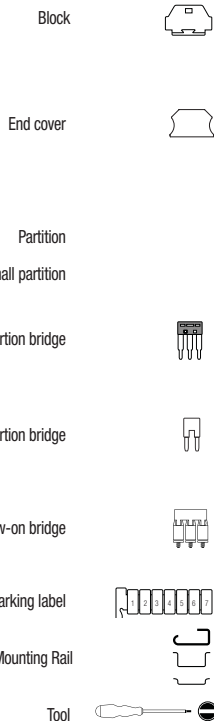

Test Blocks



DTST2 Series

Test Terminal Blocks

Test terminal blocks with convenient test sockets, plugs, jumpers and accessories to make your circuit troubleshooting easy.



DTST2

Approval		
Technical Data		
Rated voltage	300V/600V	660V
Rated current	48A/5A	41A
Conductor cross-section, solid (AWG/mm ²)	20-8 / 0.5-6	
Conductor cross-section, flexible (AWG/mm ²)	20-8 / 0.5-6	
Rated impulse withstand voltage	6kV	
Torque(N•m)	2	
Torque(lb-in)	17.7	
Screw	M4	
Wire strip length(mm)	8	
WxHxD(mm)	8 x 65.6 x 47.5	
Colors	Cat. No.	
● Grey	DTST2-GY	

Accessories		
Cat. No.		
● Grey	DTST-GY-ND	
2-pole	DS6A02	
3-pole	DS6A03	
	C002-0101-BK C002-0101-RD	
	DS6S1-BK DS6S1-OR DS6S1-YW DS6S1-RD	
	C002-0201	
	C002-0301	
2-pole	CSC-602P	
3-pole	CSC-603P	
4-pole	CSC-604P	
10-pole	CSC-610P	
2-pole	DS6-02P	
3-pole	DS6-03P	
4-pole	DS6-04P	
10-pole	DS6-10P	
Marking label	TM26CB	
Mounting Rail	DRL32MMG DRL35MMHI DRL35MMLD	
Tool	0.6 x 3.5mm	

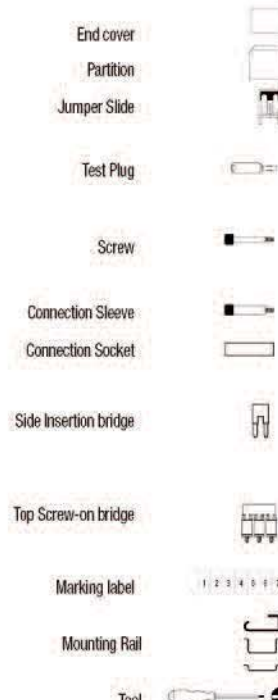

Panel Mount Blocks



Panel Mount Series

Flexible alternative to barrier strips with screw and spring-clamp wiring connections for feed through and one-to-two power distribution. Use side insertion bridge to achieve any connection topology.



Approval		
Technical Data	UL	IEC
Rated voltage	300V	500V
Rated current	20A	24A
Conductor cross-section, solid (AWG/mm²)	22-12 / 0.5-2.5	
Conductor cross-section, flexible (AWG/mm²)	22-12 / 0.5-2.5	
Rated impulse withstand voltage	7kV	
Torque(N•m)	0.39	
Torque(lb-in)	3.5	
Screw	M2.5	
Wire strip length(mm)	6-8	
WxHxD(mm)	5.1 x 20 x 22	

Colors	Cat. No.
● Grey	P20S-GY-01

Accessories	Cat. No.
● Grey	P20S-GY-ND

2-pole	CSC-2-502PS
3-pole	CSC-2-503PS
4-pole	CSC-2-504PS
10-pole	CSC-2-510PS

Marking label	Cat. No.
	TM20CB

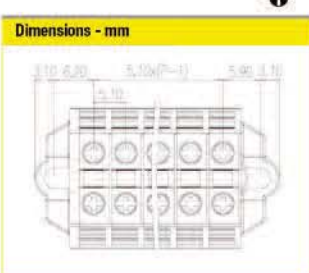

Approval		
Technical Data	UL	IEC
Rated voltage	300V	500V
Rated current	30A	32A
Conductor cross-section, solid (AWG/mm²)	22-10 / 0.5-4	
Conductor cross-section, flexible (AWG/mm²)	22-10 / 0.5-4	
Rated impulse withstand voltage	7kV	
Torque(N•m)	0.49	
Torque(lb-in)	4.3	
Screw	M3	
Wire strip length(mm)	6-8	
WxHxD(mm)	6.1 x 22 x 23	

Colors	Cat. No.
● Grey	P30S-GY-01

Accessories	Cat. No.
● Grey	P30S-GY-ND

2-pole	CSC-402PS
3-pole	CSC-403PS
4-pole	CSC-404PS
10-pole	CSC-410PS

Marking label	Cat. No.
	TM21CB

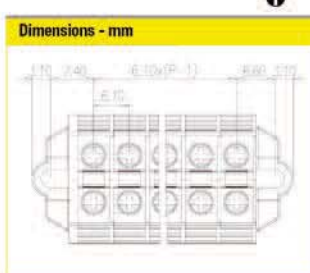

Approval		
Technical Data	UL	IEC
Rated voltage	300V	500V
Rated current	65A	41A
Conductor cross-section, solid (AWG/mm²)	20-6 / 1.5-10	
Conductor cross-section, flexible (AWG/mm²)	20-6 / 1.5-10	
Rated impulse withstand voltage	8kV	
Torque(N•m)	1.18	
Torque(lb-in)	10.4	
Screw	M4	
Wire strip length(mm)	9-11	
WxHxD(mm)	8 x 29.8 x 30	

Colors	Cat. No.
● Grey	P65S-GY-01

Accessories	Cat. No.
● Grey	P65S-GY-ND

2-pole	CSC-602PS
3-pole	CSC-603PS
4-pole	CSC-604PS
10-pole	CSC-610PS

Marking label	Cat. No.
	TM22CB

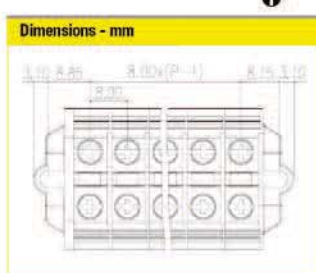

- Block
- End cover
- Side insertion bridge
- Marking label
- Tool

Panel Mount Blocks

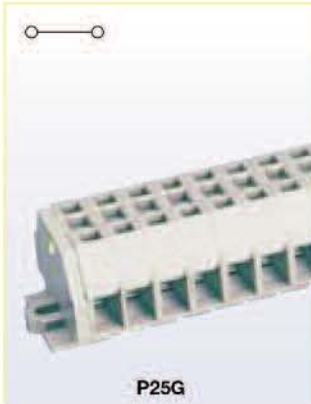

Approval		
Technical Data	UL	IEC
Rated voltage	600V	660V
Rated current	25A	24A
Conductor cross-section, solid (AWG/mm ²)	28-12 / 0.5-2.5	
Conductor cross-section, flexible (AWG/mm ²)	14-12 / 0.5-2.5	
Rated impulse withstand voltage	8kV	
Torque(N•m)	Spring Clamp	
Torque(lb-in)	Spring Clamp	
Screw	N/A	
Wire strip length(mm)	7-8	
WxHxD(mm)	6 x 28 x 18	
Colors	Cat. No.	
● Grey	P25G-GY-01	

Approval		
Technical Data	UL	IEC
Rated voltage	600V	660V
Rated current	25A	24A
Conductor cross-section, solid (AWG/mm ²)	28-12 / 0.5-2.5	
Conductor cross-section, flexible (AWG/mm ²)	14-12 / 0.5-2.5	
Rated impulse withstand voltage	8kV	
Torque(N•m)	Spring Clamp	
Torque(lb-in)	Spring Clamp	
Screw	N/A	
Wire strip length(mm)	7-8	
WxHxD(mm)	10 x 28 x 18	
Colors	Cat. No.	
● Grey	2P25G-GY-01	

Accessories	Cat. No.
● Grey	P25G-GY-ND
2-pole	DS-204
3-pole	N/A
4-pole	N/A
10-pole	N/A
	TM20CB
	0.4 x 2.5mm

Accessories	Cat. No.
● Grey	P25G-GY-ND
2-pole	DS-204
3-pole	N/A
4-pole	N/A
10-pole	N/A
	TM20CB
	0.4 x 2.5mm

Connectors

Short-Circuit Current Ratings (SCCRs)

No.	Description	Part Number*	Volts	Amps	Wire range for SCCR	SCCR Level	Fuse Class					
							RK5	RK1	J/CF	T	G	CC
1	Terminal Block	DS20-XX	600	20	12-14	100kA		30	60	60	60	30
1	End Cover	DS20-XX-ND										
2	Terminal Block	DS30-XX	600	30	10-18	100kA		30	60	60	60	30
2	End Cover	DS20-XX-ND										
3	Terminal Block	DS50-XX	600	50	8 - 18	100kA		30	60	60	60	30
3	End Cover	DS50-XX-ND										
4	Terminal Block	DM20-XX	300	20	12 - 16	100kA		30	60	60	60	30
4	End Cover	DM20-XX-ND										
5	Terminal Block	DM30-XX	300	30	10 - 16	100kA		30	60	60	60	30
5	End Cover	DM30-XX-ND										
6	Terminal Block	DM50-XX	300	50	8 - 16	100kA		30	60	60	60	30
6	End Cover	DM50-XX-ND										
7	Terminal Block	DP25-XX	600	25	12 - 18	100kA		30	60	60	60	30
7	End Cover	DP25-XX-ND										
8	Terminal Block	DP35-XX	600	35	10 - 18	100kA		30	60	60	60	30
8	End Cover	DP25-XX-ND										
9	Terminal Block	DP45-XX	600	45	8 - 18	100kA		30	60	60	60	30
9	End Cover	DP25-XX-ND										
10	Terminal Block	DP60-XX	600	60	6 - 18	100kA		30	60	60	60	30
10	End Cover	DP25-XX-ND										
11	Terminal Block	DP100-XX	600	100	14-3	200kA	30	60	100	100	60	30
11	End Cover	DP100-XX-ND										
12	Terminal Block	DP150-XX	600	150	1/0 - 12	100kA	30	100	200	200	60	30
13	Terminal Block	DP230-XX	600	230	2-4/0	200kA	60	100	200	200	60	30
14	Terminal Block	DP370-XX	600	370	300 - 500kcmil	200kA	100	200	400	400	60	30
15	Grounding Block	DG25-XX	600		12 - 18	100kA		30	60	60	60	30
16	Grounding Block	DG35-XX	600		10 - 16	100kA	30	30	60	60	60	30
17	Grounding Block	DG60-XX	600		16-8	200kA	30	60	100	100	60	30
18	Grounding Block	DG100-XX	600		14-6	200kA		60	100	100	60	30
19	Grounding Block	DG150-XX	600		12-2	200kA	30	60	100	100	60	30

* The "XX" in part number indicates color.

Short-Circuit Current Ratings (SCCRs)

No.	Description	Part Number*	Volts	Amps	Wire range for SCCR	SCCR Level	Fuse Class					
							RK5	RK1	J/CF	T	G	CC
20	Grounding Block	DG230-XX	600		2-4/0	200kA	30	60	100	100	60	30
21A	Terminal Block	DDP30-XX (upper)	300	30	10 - 18	100kA		30	60	60	60	30
21A	End Cover	DDP30-XX-ND										
21B	Terminal Block	DDP30-XX (lower)	300	30	10 - 18	100kA		30	60	60	60	30
21B	End Cover	DDP30-XX-ND										
22	Terminal Block	DDNS10-XX	300	10	16 - 18	100kA		30	60	60	60	30
22	End Cover	DDNS10-XX-ND										
23	Terminal Block	DIS10-XX	300	10	16 - 16	100kA		30	60	60	60	30
23	End Cover	DIS10-XX-ND										
24	Fuse terminal block	F520ST-XX	300	6.3	18 - 18	100kA		30	60	60	60	30
24	End Cover	F520-XX-ND										
25	Fuse terminal block	F520STLED-XX	300	6.3	18 - 18	100kA		30	60	60	60	30
25	End Cover	F520-XX-ND										
26	Fuse terminal block	F520DDST-XX (upper)	300	16	10 - 18	100kA		30	60	60	60	30
26	End Cover	F520DD-XX-ND										
27	Fuse terminal block	F520DDST-XX (lower)	300	30	10 - 18	100kA		30	60	60	60	30
27	End Cover	F520DD-XX-ND										
28	Fuse terminal block	F520TOP-XX	600	6.3	6 - 18	100kA		30	60	60	60	30
29	Terminal Block	DTST2-XX	300/600	48/5	8 - 20	100kA		30	60	60	60	30
29	End Cover	DTST-XX-ND										
30	Terminal Block	P20S-XX	300	20	12 - 16	100kA		30	60	60	60	30
30	End Cover	P20S-XX-ND										
31	Terminal Block	P30S-XX	300	30	10 - 16	100kA		30	60	60	60	30
31	End Cover	P30S-XX-ND										
32	Terminal Block	P65S-XX	300	65	6 - 16	100kA		30	60	60	60	30
32	End Cover	P65S-XX-ND										
33	Terminal Block	P25G-XX	600	25	12 - 14	100kA		30	60	60	60	30
33	End Cover	P25G-XX-ND										
34	Terminal Block	2P25G-XX	600	25	12 - 14	100kA		30	60	60	60	30
34	End Cover	P25G-XX-ND										

* The "XX" in part number indicates color.

Accessories

Top Screw-On Bridges

DS2-5-XXP



Use with DP25 DG25

DDNS10

Poles (XX) 02, 03, 04, 10

DS4-XXP



Use with DP35 DDP30

Poles (XX) 02, 03, 04, 10

DS6-XXP



Use with DP45

DTST2

Poles (XX) 02, 03, 04, 10

DS10-XXP



Use with DP60

Poles (XX) 02, 03, 04, 10

Dimensions - mm

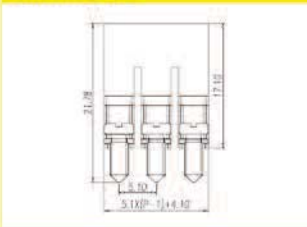

Dimensions - mm

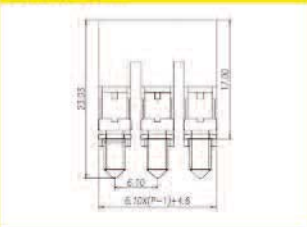

Dimensions - mm

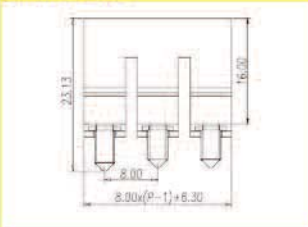

Dimensions - mm

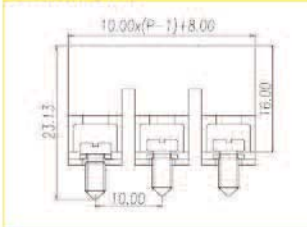

DS16 - XXP



Use with DP100

Poles (XX) 02, 03, 04, 10

DS35 - XXP



Use with DP150

Poles (XX) 02, 03, 04, 10

Dimensions - mm

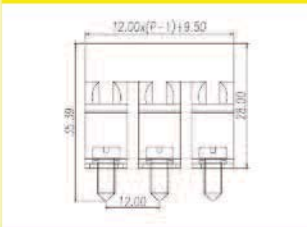

Dimensions - mm

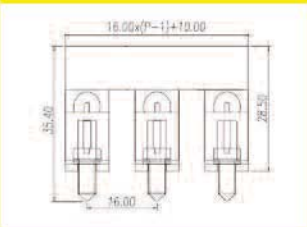

Accessories

End Brackets

BRKT-ND



Use with	DRL35MMHI
	DRL35MMLO
Torque(N•m)	N/A
Torque(lb-in)	N/A
Screw	N/A

Dimensions - mm

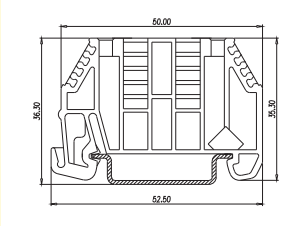

BRKT-NDSCRW

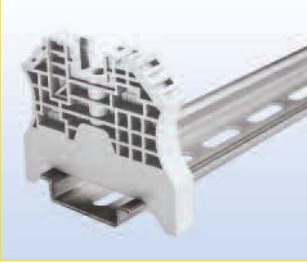

Use with	DRL35MMHI
	DRL35MMLO
Torque(N•m)	0.5
Torque(lb-in)	4.4
Screw	M3

Dimensions - mm

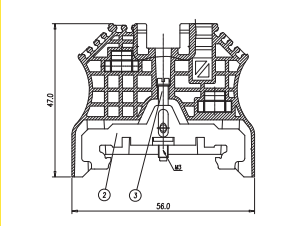

BRKT-NDSCRW2



Use with	DRL35MMHI
	DRL35MMLO
Torque(N•m)	0.78
Torque(lb-in)	6.9
Screw	M3

Dimensions - mm

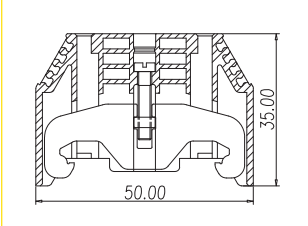

BRKT-NDSCRW3

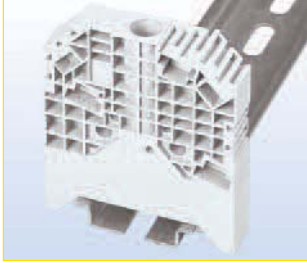

Use with	DRL35MMHI
	DRL35MMLO
Torque(N•m)	1.8
Torque(lb-in)	15.9
Screw	M4

Dimensions - mm

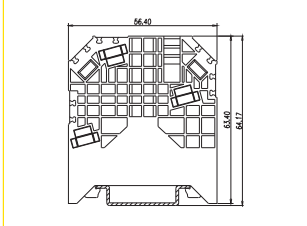

Partition Plates

DKSPS-001



Use with	DP25	DP35
	DP45	DP60

DKSPS-002



Use with	DP25	DP35
	DP45	DP60
	DIS10	

DKSPS-006



Use with	DTST2
----------	-------

DKNPS-001



Use with	DS20	DS30
----------	------	------

DKNPS-002



Use with	DS50
----------	------

DKNPS-003



Use with	DP100
----------	-------



DKNPS-004





Use with	DP150
----------	-------

Accessories

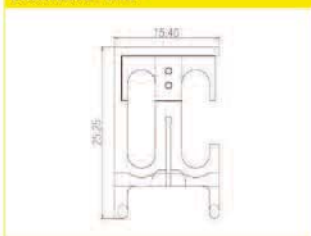
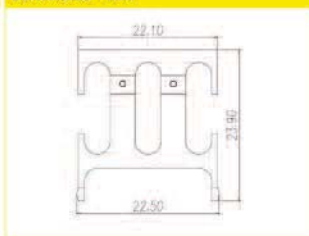
Jumper Slides





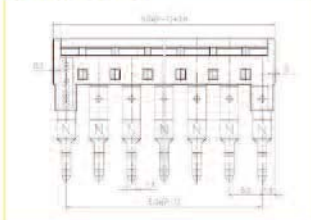
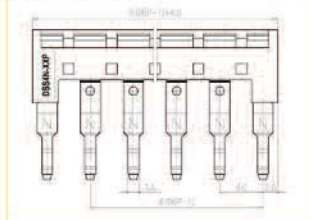
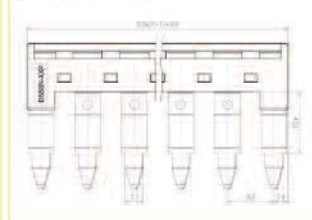

DS6A02		DS6A03	
			
Use with	DTST2	Use with	DTST2
Poles	02	Poles	03
Dimensions - mm		Dimensions - mm	
			

Top Insertion Bridges

DSS2-5N-XXP		DSS4N-XXP		DSS6N-XXP	
					
Use with	DS20	Use with	DS30	Use with	DS50
Poles (XX)	02, 03, 04, 10	Poles (XX)	02, 03, 04, 10	Poles (XX)	02, 03, 04, 10
Dimensions - mm		Dimensions - mm		Dimensions - mm	
					

Accessories

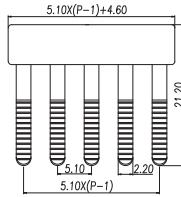
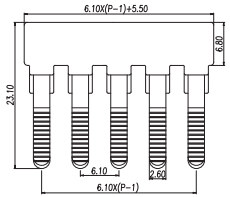
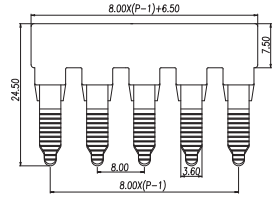
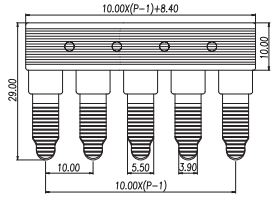
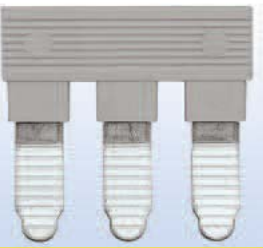
Side Insertion Bridges

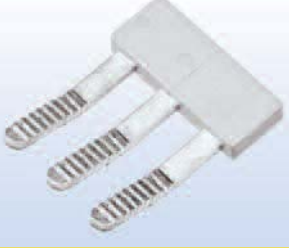
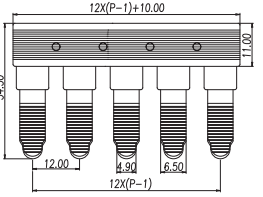
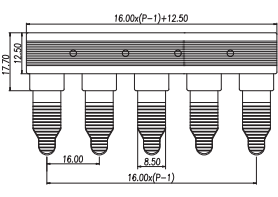
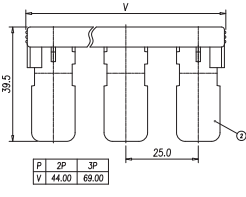
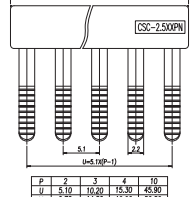
CSC-2-5XXP	CSC-4XXP	CSC-6XXP	CSC-10XXP
			
Use with DP25 DIS10 P20S DDNS10	Use with DP35 DDP30	Use with DTST2 DP45	Use with DP60
Poles (XX) 02, 03, 04, 10	Poles (XX) 02, 03, 04, 10	Poles (XX) 02, 03, 04, 10	Poles (XX) 02, 03, 04, 10
Dimensions - mm	Dimensions - mm	Dimensions - mm	Dimensions - mm
			
CSC-16XXP	CSC-35XXP	CSC-95XXP	CSC-2-5XXPN
			
Use with DP100	Use with DP150	Use with DP230	Use with DS20
Poles (XX) 02, 03, 04, 10	Poles (XX) 02, 03, 04, 10	Poles (XX) 02, 03, 04, 10	Poles (XX) 02, 03, 04, 10
Dimensions - mm	Dimensions - mm	Dimensions - mm	Dimensions - mm
			

Connectors

Accessories

Side Insertion Bridges

CSC-4XXPN

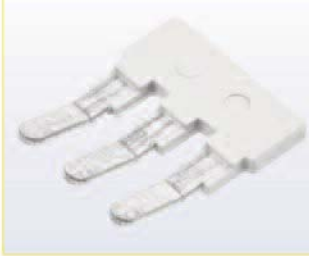

Use with DS30

CSC-6XXPN



Use with DS50

DS-204



Use with P25G
2P25G

CSC-2-5XXPS



Use with DM20
P20S

Poles (XX) 02, 03, 04, 10

Poles (XX) 02, 03, 04, 10

Poles 02

Poles (XX) 02, 03, 04, 10

Dimensions - mm

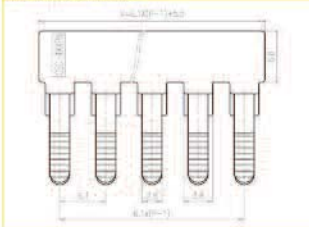

Dimensions - mm

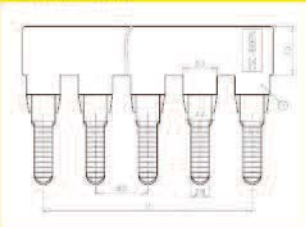

Dimensions - mm

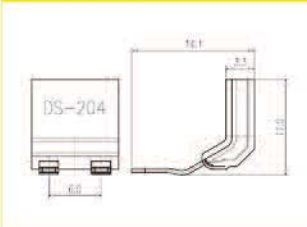

Dimensions - mm

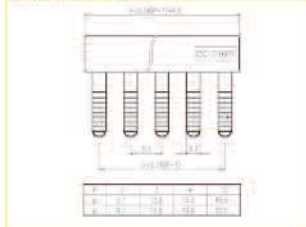

CSC-4XXPS



Use with DM30
P30S

CSC-6XXPS



Use with DM50
P65S

Poles (XX) 02, 03, 04, 10

Poles (XX) 02, 03, 04, 10

Dimensions - mm

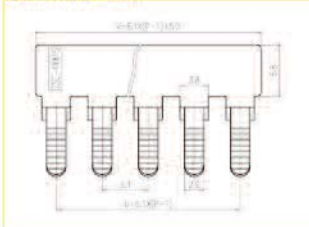

Dimensions - mm

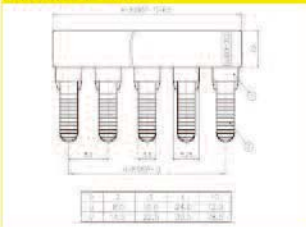

Accessories

Mounting Rails and Brackets

<p>DRL15MM* (15mm DIN-Rail)</p> 	<p>DRL32MMG* (32mm G-Type)</p> 	<p>DRL35MMLO* (35mm DIN-Rail - Low Profile)</p> 	<p>DRL35MMHI* (35mm DIN-Rail - High Profile)</p> 
<p>NFTA Series** (C-Rail)</p> 	<p>NRA Series** (C-Rail)</p> 	<p>BRKT-ANGL (Angle Bracket)</p> 	<p>BRKT-FLT (Flat Bracket)</p> 

*Available in 1 meter lengths only.

**Cut to length. Consult Bussmann for details.

BussScribe Marking System



Description

- Pen is installed manually
- USB interface to PC
- 110-240Vac power supply
- WINDOWS® Operation System

System Kit Includes:

- Plotter Pens
- Support Plate
- Software
- Plotter
- Power Supplies
- USB Cable

Description

Support plate adjustable to accommodate various sizes of marking labels. The support plate is universal and suitable for TM2xCB marking label series.

Each plotter set includes one support plate, additional plates are available separately.

Description

Disposable black ink cartridge pen.
Single pen per pack.

Marking Label Selection Chart

Part Number	Length (mm)	Width (mm)	Line x Row	Number of Tags	Applicable Block Part Numbers
TM20CB	5.8	5.1	20 x 10	200	F20TOP, DM20, P20S, P25G, 2P25G
TM21CB	5.8	6.1	20 x 10	200	DDP30, DM30, P30S
TM22CB	5.8	8.0	20 x 8	160	DM50, P65S
TM26CB	12	5.1	12 x 12	144	DS20, DP25, DG25, DDNS10, DIS10
TM27CB	12	6.1	12 x 10	120	DS30, DP35, DG35
TM28CB	12	8.0	12 x 7	84	DS50, DP45, DP60, DP100, DP150, DP230, DG60, DG100, DG150, DG230, F520ST, F520STLED, F520DDST, DTST2

Marking Label Ordering Method (typical)

Example: TM20CB–DH01, Horizontal Marking – L1, L2, L3, N, PE

TM20CB Series - mm

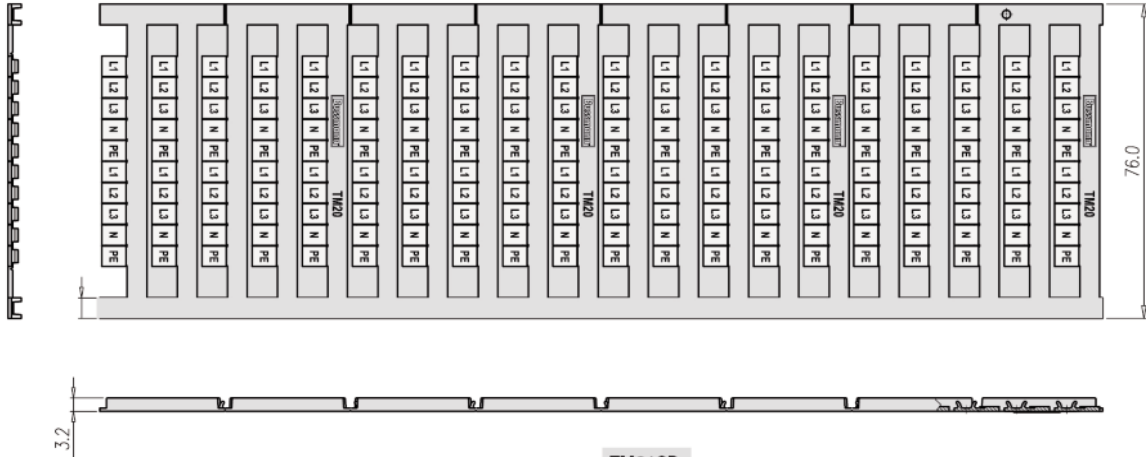

TM20CB

Part Numbers	Descriptions
TM20CB	Marking label, blank
TM20CB-DH01	Marking label, horizontal, (L1,L2,L3,N,PE) repeated 40 times
TM20CB-DH02	Marking label, horizontal, (L1,L2,L3,N) repeated 40 times
TM20CB-FH01	Marking label, horizontal, 1 to 10, repeated in 20 lines
TM20CB-FH02	Marking label, horizontal, 11 to 20, repeated in 20 lines
TM20CB-FH03	Marking label, horizontal, 21 to 30, repeated in 20 lines
TM20CB-FH04	Marking label, horizontal, 31 to 40, repeated in 20 lines
TM20CB-FH05	Marking label, horizontal, 41 to 50, repeated in 20 lines
TM20CB-EH01	Marking label, horizontal, 1 to 50, repeated in 4 sets
TM20CB-EH02	Marking label, horizontal, 51 to 100, repeated in 4 sets
TM20CB-DV01	Marking label, vertical, (L1,L2,L3,N,PE) repeated 40 times
TM20CB-DV02	Marking label, vertical, (L1,L2,L3,N) repeated 40 times
TM20CB-FV01	Marking label, vertical, 1 to 10, repeated in 20 lines
TM20CB-FV02	Marking label, vertical, 11 to 20, repeated in 20 lines
TM20CB-EV01	Marking label, vertical, 1 to 50, repeated in 4 sets

TM21CB

Part Numbers	Descriptions
TM21CB	Marking label, blank
TM21CB-DH01	Marking label, horizontal, (L1,L2,L3,N,PE) repeated 40 times
TM21CB-DH02	Marking label, horizontal, (L1,L2,L3,N) repeated 40 times
TM21CB-FH01	Marking label, horizontal, 1 to 10, repeated in 20 lines
TM21CB-FH02	Marking label, horizontal, 11 to 20, repeated in 20 lines
TM21CB-FH03	Marking label, horizontal, 21 to 30, repeated in 20 lines
TM21CB-FH04	Marking label, horizontal, 31 to 40, repeated in 20 lines
TM21CB-FH05	Marking label, horizontal, 41 to 50, repeated in 20 lines
TM21CB-EH01	Marking label, horizontal, 1 to 50, repeated in 4 sets
TM21CB-EH02	Marking label, horizontal, 51 to 100, repeated in 4 sets
TM21CB-DV01	Marking label, vertical, (L1,L2,L3,N,PE) repeated 40 times
TM21CB-DV02	Marking label, vertical, (L1,L2,L3,N) repeated 40 times
TM21CB-FV01	Marking label, vertical, 1 to 10, repeated in 20 lines
TM21CB-FV02	Marking label, vertical, 11 to 20, repeated in 20 lines
TM21CB-EV01	Marking label, vertical, 1 to 50, repeated in 4 sets

TM21CB Series - mm

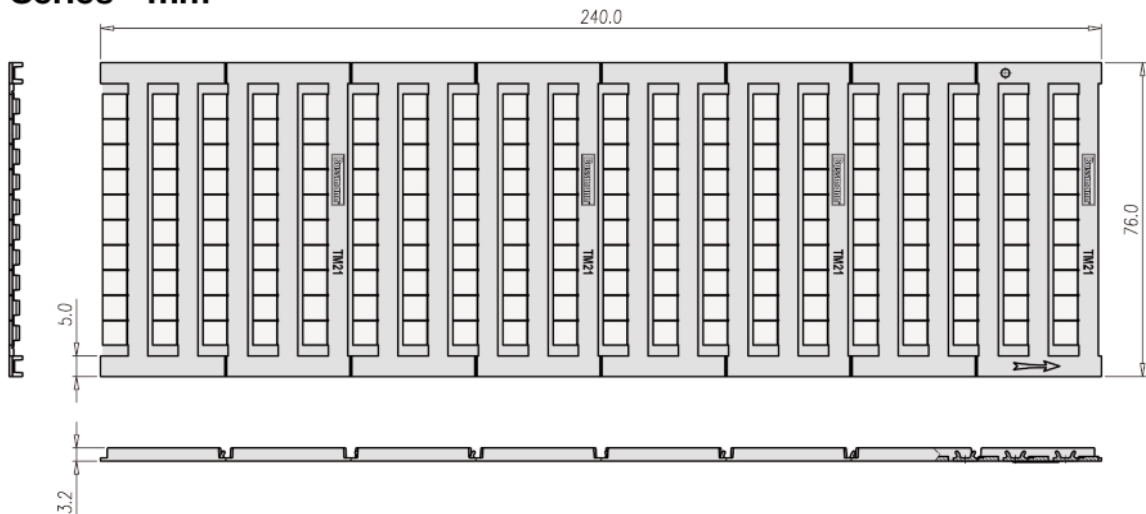

Marking Label Ordering Method (typical)

TM22CB Series - mm

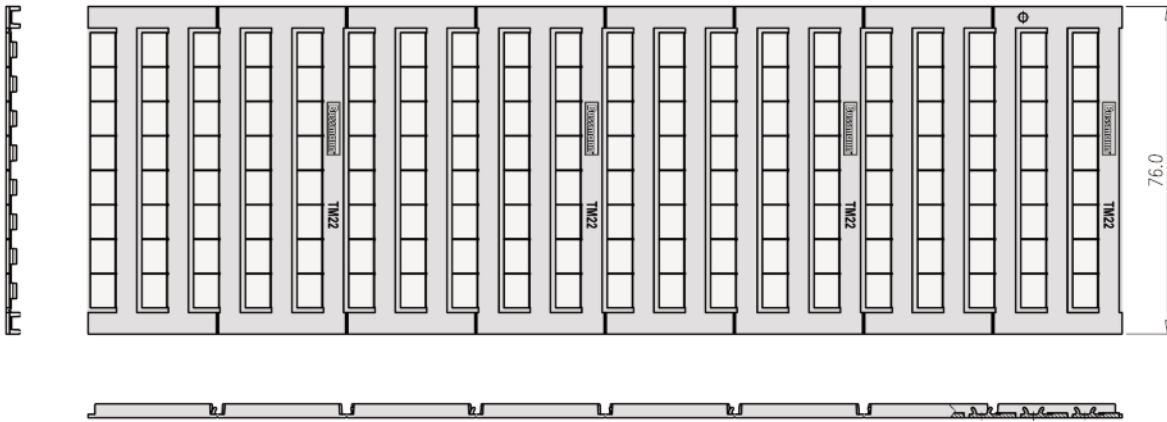

TM22CB

Part Numbers	Descriptions
TM22CB	Marking label, blank
TM22CB-DH01	Marking label, horizontal, (L1,L2,L3,N,PE) repeated 30 times
TM22CB-DH02	Marking label, horizontal, (L1,L2,L3,N) repeated 40 times
TM22CB-FH01	Marking label, horizontal, 1 to 10, repeated in 16 lines
TM22CB-FH02	Marking label, horizontal, 11 to 20, repeated in 16 lines
TM22CB-FH03	Marking label, horizontal, 21 to 30, repeated in 16 lines
TM22CB-FH04	Marking label, horizontal, 31 to 40, repeated in 16 lines
TM22CB-FH05	Marking label, horizontal, 41 to 50, repeated in 16 lines
TM22CB-EH01	Marking label, horizontal, 1 to 50, repeated in 3 sets
TM22CB-EH02	Marking label, horizontal, 51 to 100, repeated in 3 sets
TM22CB-DV01	Marking label, vertical, (L1,L2,L3,N,PE) repeated 30 times
TM22CB-DV02	Marking label, vertical, (L1,L2,L3,N) repeated 40 times
TM22CB-FV01	Marking label, vertical, 1 to 10, repeated in 16 lines
TM22CB-FV02	Marking label, vertical, 11 to 20, repeated in 16 lines
TM22CB-EV01	Marking label, vertical, 1 to 50, repeated in 3 sets

TM26CB

Part Numbers	Descriptions
TM26CB	Marking label, blank
TM26CB-DH01	Marking label, horizontal, (L1,L2,L3,N,PE) repeated 24 times
TM26CB-DH02	Marking label, horizontal, (L1,L2,L3,N) repeated 36 times
TM26CB-FH01	Marking label, horizontal, 1 to 10, repeated in 12 lines
TM26CB-FH02	Marking label, horizontal, 11 to 20, repeated in 12 lines
TM26CB-FH03	Marking label, horizontal, 21 to 30, repeated in 12 lines
TM26CB-FH04	Marking label, horizontal, 31 to 40, repeated in 12 lines
TM26CB-FH05	Marking label, horizontal, 41 to 50, repeated in 12 lines
TM26CB-EH01	Marking label, horizontal, 1 to 50, repeated in 2 sets
TM26CB-EH02	Marking label, horizontal, 51 to 100, repeated in 2 sets
TM26CB-DV01	Marking label, vertical, (L1,L2,L3,N,PE) repeated 24 times
TM26CB-DV02	Marking label, vertical, (L1,L2,L3,N) repeated 36 times
TM26CB-FV01	Marking label, vertical, 1 to 10, repeated in 12 lines
TM26CB-FV02	Marking label, vertical, 11 to 20, repeated in 12 lines
TM26CB-EV01	Marking label, vertical, 1 to 50, repeated in 2 sets

TM26CB Series - mm

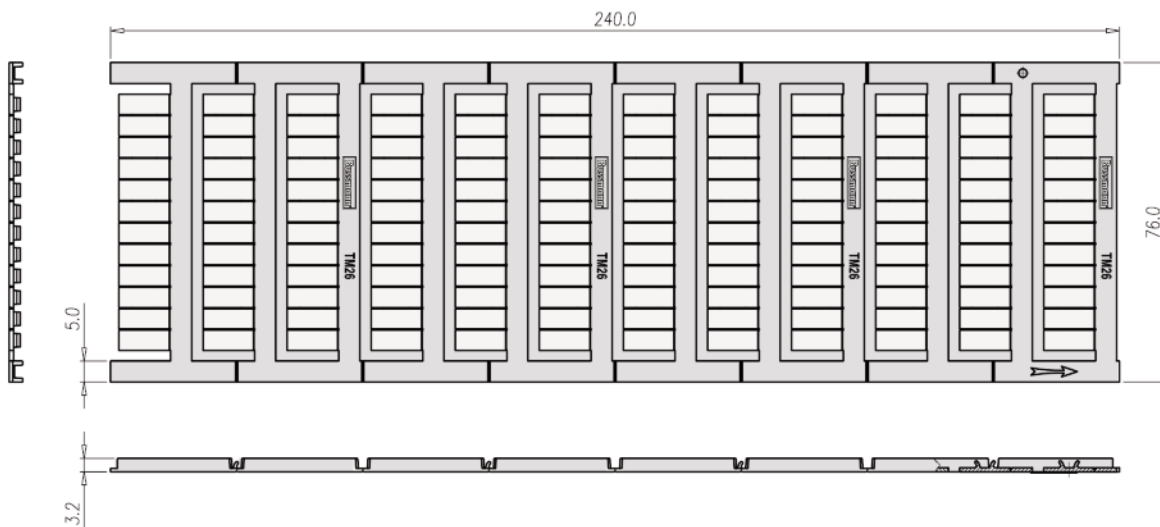

Marking Label Ordering Method (typical)

TM27CB Series - mm

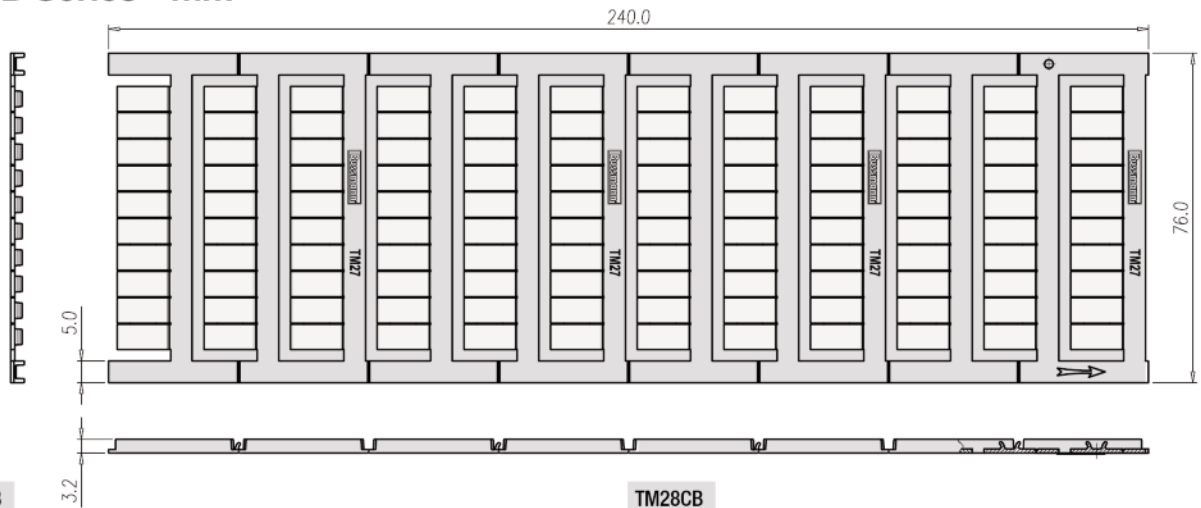

TM27CB

Part Numbers	Descriptions
TM27CB	Marking label, blank
TM27CB-DH01	Marking label, horizontal, (L1,L2,L3,N,PE) repeated 40 times
TM27CB-DH02	Marking label, horizontal, (L1,L2,L3,N) repeated 24 times
TM27CB-FH01	Marking label, horizontal, 1 to 10, repeated in 12 lines
TM27CB-FH02	Marking label, horizontal, 11 to 20, repeated in 12 lines
TM27CB-FH03	Marking label, horizontal, 21 to 30, repeated in 12 lines
TM27CB-FH04	Marking label, horizontal, 31 to 40, repeated in 12 lines
TM27CB-FH05	Marking label, horizontal, 41 to 50, repeated in 12 lines
TM27CB-EH01	Marking label, horizontal, 1 to 50, repeated in 2 sets
TM27CB-EH02	Marking label, horizontal, 1 to 50, repeated in 2 sets
TM27CB-DV01	Marking label, vertical, (L1,L2,L3,N,PE) repeated 24 times
TM27CB-DV02	Marking label, vertical, (L1,L2,L3,N) repeated 24 times
TM27CB-FV01	Marking label, vertical, 1 to 10, repeated in 12 lines
TM27CB-FV02	Marking label, vertical, 11 to 20, repeated in 12 lines
TM27CB-EV01	Marking label, vertical, 1 to 50, repeated in 2 sets

TM28CB

Part Numbers	Descriptions
TM28CB	Marking label, blank
TM28CB-DH01	Marking label, horizontal, (L1,L2,L3,N,PE) repeated 12 times
TM28CB-DH02	Marking label, horizontal, (L1,L2,L3,N) repeated 20 times
TM28CB-FH01	Marking label, horizontal, 1 to 10, repeated in 8 lines
TM28CB-FH02	Marking label, horizontal, 11 to 20, repeated in 8 lines
TM28CB-FH03	Marking label, horizontal, 21 to 30, repeated in 8 lines
TM28CB-FH04	Marking label, horizontal, 31 to 40, repeated in 8 lines
TM28CB-FH05	Marking label, horizontal, 41 to 50, repeated in 8 lines
TM28CB-EH01	Marking label, horizontal, 1 to 50, repeated in 1 sets
TM28CB-EH02	Marking label, horizontal, 51 to 100, repeated in 1 sets
TM28CB-DV01	Marking label, vertical, (L1,L2,L3,N,PE) repeated 12 times
TM28CB-DV02	Marking label, vertical, (L1,L2,L3,N) repeated 20 times
TM28CB-FV01	Marking label, vertical, 1 to 10, repeated in 8 lines
TM28CB-FV02	Marking label, vertical, 11 to 20, repeated in 8 lines
TM28CB-EV01	Marking label, vertical, 1 to 50, repeated in 1 sets

TM28CB Series - mm

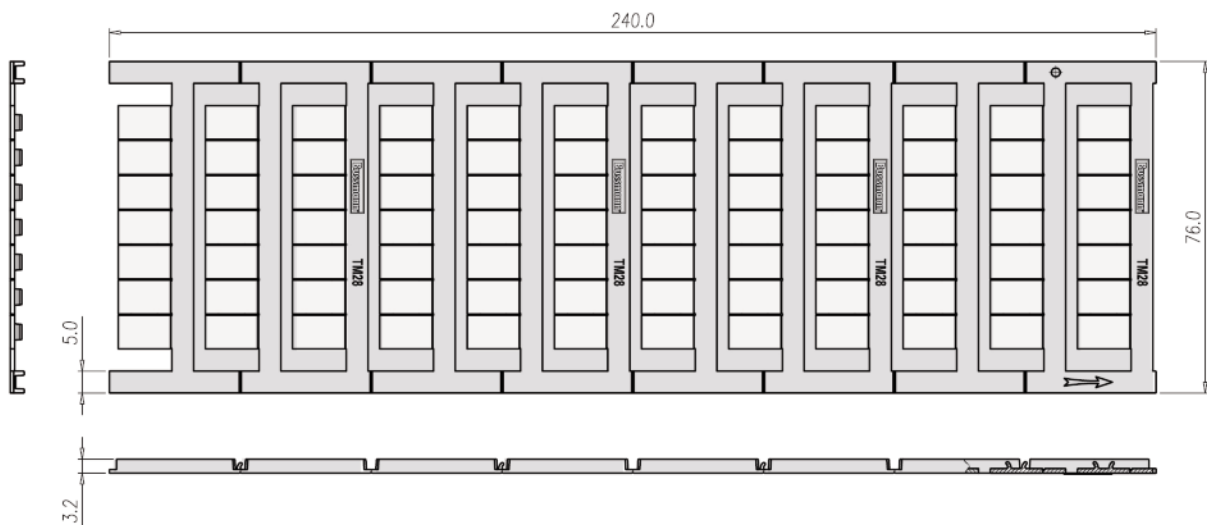

NDN Series Feed Through Blocks



NDN Series

The NDN Series features a compact line of rail-mounted terminal blocks suitable for both 35mm DIN-Rail or C-Rail applications. Products easily snap onto the mounting rail for a quick, simple, low-cost solution. Available accessories include jumpers and marking tape.

UL E62622
CSA File 15364
CSA File 47235 (NDN1, NDN111)

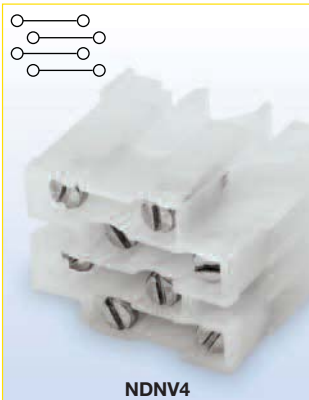

NDNV4

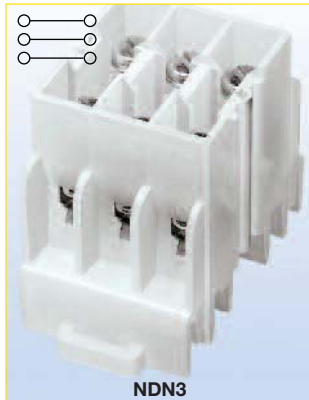

NDN3

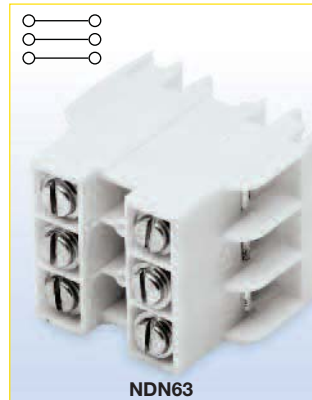

NDN63

Approval	
Technical Data	
Rated voltage	600V
Rated Current	30A
Center spacing, in (mm)	0.25 / 6.35
Conductor cross-section, flexible (AWG/mm ²)	22~10 / 0.5~6
Number of Poles	4
Circuits per foot	48
Torque(N•m)	2
Torque(lb-in)	18
Screw	#6-32
WxHxD(mm)	25.4 x 34 x 42.4

Colors	Cat. No.
○ White (Standard)	NDNV4-WH
● Black	NDNV4-BK
● Yellow	NDNV4-YE

Approval	
Technical Data	
Rated voltage	600V
Rated Current	30A
Center spacing, in (mm)	0.3 / 7.62
Conductor cross-section, flexible (AWG/mm ²)	22~10 / 0.5~6
Number of Poles	3
Circuits per foot	38
Torque(N•m)	2
Torque(lb-in)	18
Screw	#6-32
WxHxD(mm)	23.9 x 33.3 x 42.4

Colors	Cat. No.
○ White (Standard)	NDN3-WH
● Black	NDN3-BK
● Blue	NDN3-BL
● Yellow	NDN3-YE
● Red	NDN3-RE

Approval	
Technical Data	
Rated voltage	600V
Rated Current	65A
Center spacing, in (mm)	0.375 / 9.52
Conductor cross-section, flexible (AWG/mm ²)	18~6 / 1~16
Number of Poles	3
Circuits per foot	30
Torque(N•m)	4
Torque(lb-in)	35
Screw	#10-32
WxHxD(mm)	29.7 x 36.8 x 42.4

Colors	Cat. No.
○ White (Standard)	NDN63-WH
● Black	NDN63-BK
● Yellow	NDN63-YE

Accessories	Cat. No.
4 circuits	JN4
	MTC6
35mm DIN-Rail	DRL35MML0 DRL35MMHI
C-Rail	NFTA Series
C-Rail (low profile)	NRA Series
Modular Option	N/A

Accessories	Cat. No.
2 circuits	JNDN3
	MT12-1-2
35mm DIN-Rail	DRL35MML0 DRL35MMHI
C-Rail	NFTA Series
C-Rail (low profile)	NRA Series
Modular Option	N/A

Accessories	Cat. No.
2 circuits	JN3
	MT12-1-2
35mm DIN-Rail	DRL35MML0 DRL35MMHI
C-Rail	NFTA Series
C-Rail (low profile)	NRA Series
Modular Option	N/A

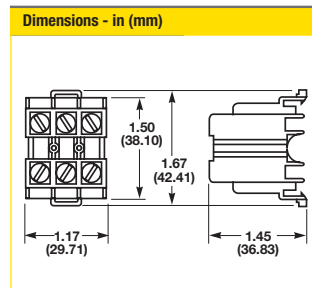
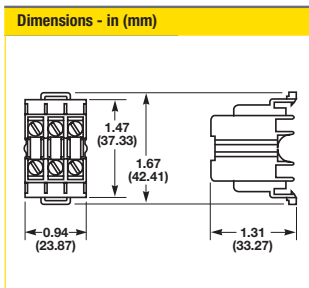
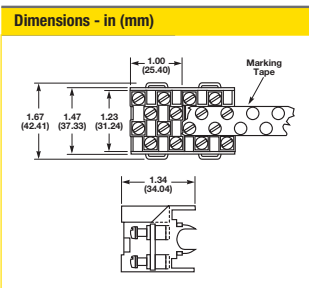

- Block
- Jumper
- Marking Tape
- Mounting
- Modular Option

NDN Series Feed Through Blocks

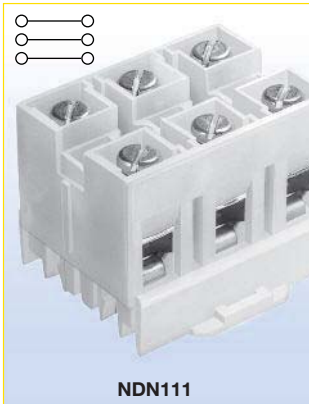

Approval	
----------	--

Approval	
----------	--

Technical Data	
Rated voltage	600V
Rated Current	90A
Center spacing in (mm)	0.635 / 16.31
Conductor cross-section, flexible (AWG/mm ²)	18~2 / 1~35
Number of Poles	1
Circuits per foot	18
Torque(N•m)	3.6
Torque(lb-in)	32
Screw	1/4-28
WxHxD(mm)	15 x 30.3 x 43.5

Technical Data	
Rated voltage	600V
Rated Current	90A
Center spacing in (mm)	0.635 / 16.31
Conductor cross-section, flexible (AWG/mm ²)	18~2 / 1~35
Number of Poles	3
Circuits per foot	18
Torque(N•m)	3.6
Torque(lb-in)	32
Screw	1/4-28
WxHxD(mm)	47.5 x 36.6 x 43.5

Colors	Cat. No.
○ White (Standard)	NDN1-WH

Colors	Cat. No.
○ White (Standard)	NDN111-WH
● Black	NDN111-BK
● Blue	NDN111-BL
● Yellow	NDN111-YE
● Red	NDN111-RE

Accessories	Cat. No.
	MT12-1-2
35mm DIN-Rail	DRL35MML0 DRL35MMHI
C-Rail	NFTA Series
C-Rail (low profile)	NRA Series
	NDN1A-WH

Accessories	Cat. No.
2 circuits	JN1
	MT12-1-2
35mm DIN-Rail	DRL35MML0 DRL35MMHI
C-Rail	NFTA Series
C-Rail (low profile)	NRA Series
	NDN111A-WH, NDN111A-BK, NDN111A-YE

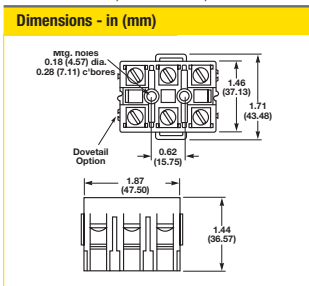
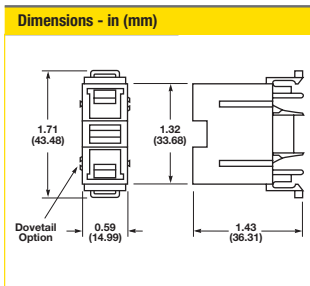

Connectors

C-Rail Feed Through Blocks



C-Rail Series

C-Rail terminal blocks provide a low-profile, compact foot-print solution for various wire connection applications. Products feature an easy, snap-on installation method and an array of accessories including jumpers and marking strips.

UL E62622 (excluding N512)
CSA File 15364
CSA File 47235 (NFT3)

- Block 
- Jumper
- Marking Tape
- Mounting

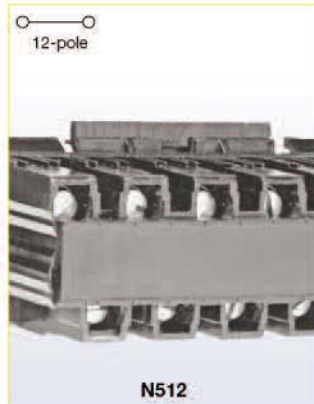

N512

Approval 	
Technical Data	
Rated voltage	300V 600V
Rated current	20A 5A
Center spacing in (mm)	0.197 / 5.0
Conductor cross-section, flexible (AWG/mm ²)	22-12 / 0.5-4
Number of Poles	12
Circuits per foot	60
Torque(N•m)	1.4
Torque(lb-in)	12
Screw	#4-48
WxHxD(mm)	61.0 x 27.7 x 22.4

Colors	Cat. No.
● Black (Standard)	N512-BK

Accessories	Cat. No.
12 circuits	JN512
	AT512
15mm DIN-Rail C-Rail	DRL15MM NFTA Series
C-Rail (low profile)	NRA Series

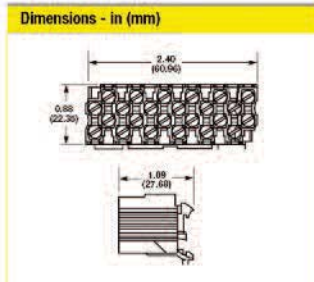

NFT2

Approval 	
Technical Data	
Rated voltage	600V
Rated Current	40A
Center spacing in (mm)	0.28 / 7.13
Conductor cross-section, flexible (AWG/mm ²)	22-8 / 0.5-10
Number of Poles	2
Circuits per foot	38
Torque(N•m)	2
Torque(lb-in)	18
Screw	#8-32
WxHxD(mm)	16.5 x 34.7 x 42.8

Colors	Cat. No.
○ White (Standard)	NFT2-WH
● Black	NFT2-BK
● Blue	NFT2-BL
● Red	NFT2-RE

Accessories	Cat. No.
2 circuits	JN2
	MT12-1-2
C-Rail	NFTA Series
C-Rail (low profile)	NRA Series

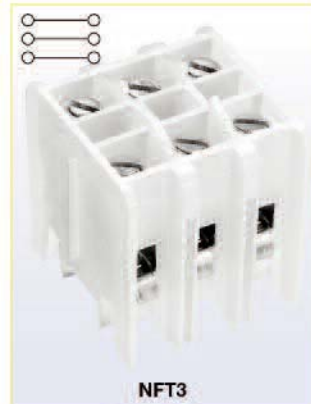
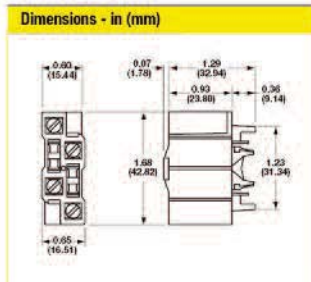

NFT3

Approval 	
Technical Data	
Rated voltage	600V
Rated Current	40A
Center spacing in (mm)	0.39 / 9.91
Conductor cross-section, flexible (AWG/mm ²)	22-8 / 0.5-10
Number of Poles	3
Circuits per foot	28
Torque(N•m)	2
Torque(lb-in)	18
Screw	#8-32
WxHxD(mm)	30.0 x 32.9 x 31.4

Colors	Cat. No.
○ White (Standard)	NFT3-WH
● Black	NFT3-BK
● Blue	NFT3-BL
● Yellow	NFT3-YE
● Red	NFT3-RE

Accessories	Cat. No.
2 circuits	JN3
	MT12-1-2
C-Rail	NFTA Series
C-Rail (low profile)	NRA Series

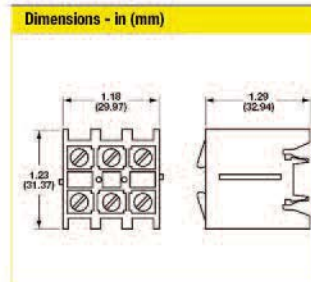

C-Rail Feed Through Blocks





NC3





NSE3



NSS3

Approval  	
Technical Data	
Rated voltage	600V
Rated Current	175A
Center spacing in (mm)	1.06 / 26.92
Conductor cross-section, flexible (AWG/mm ²)	14-2/0 / 2.5-70 Cu/AL
Number of Poles	3
Circuits per foot	11
Torque(N•m)	5.1
Torque(lb-in)	45
Screw	5/16 - 24
WxHxD(mm)	79.4 x 44.5 x 44.5
Colors	Cat. No.
○ White (Standard)	NC3-WH
● Black	NC3-BK

Approval  	
Technical Data	
Rated voltage	600V
Rated Current	115A
Center spacing in (mm)	1.06 / 26.92
Conductor cross-section, flexible (AWG/mm ²)	Ring Terminals Only
Number of Poles	3
Circuits per foot	11
Torque(N•m)	3.6
Torque(lb-in)	32
Screw	1/4 - 28
WxHxD(mm)	79.2 x 38.9 x 44.5
Colors	Cat. No.
○ White (Standard)	NSE3-WH

Approval  	
Technical Data	
Rated voltage	600V
Rated Current	30A
Center spacing in (mm)	0.385 / 9.77
Conductor cross-section, flexible (AWG/mm ²)	Ring Terminals Only
Number of Poles	3
Circuits per foot	28
Torque(N•m)	1.4
Torque(lb-in)	12
Screw	#6-32
WxHxD(mm)	31.5 x 33.7 x 31.8
Colors	Cat. No.
○ White (Standard)	NSS3-WH
● Black	NSS3-BK

Accessories	Cat. No.
Panel Mount C-Rail	NFTA Series
C-Rail (low profile)	NRA Series
MT12-1-2	

Accessories	Cat. No.
Panel Mount C-Rail	NFTA Series
C-Rail (low profile)	NRA Series
2 circuits	JNSE3
MT12-1-2	

Accessories	Cat. No.
Panel Mount C-Rail	NFTA Series
C-Rail (low profile)	NRA Series
2 circuits	JNSS3
MT12-1-2	

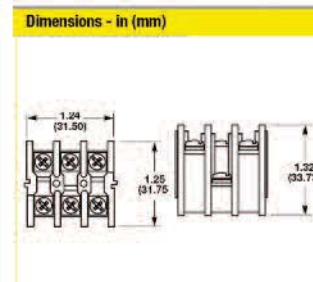
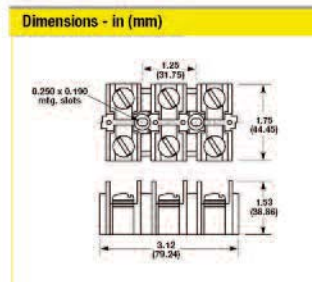
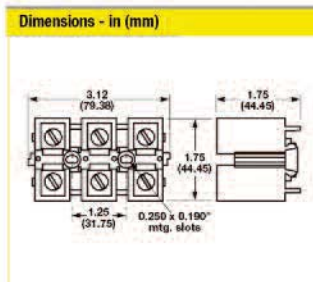

Depluggable Blocks



Depluggable Blocks

Depluggable terminal blocks are available for both 35mm DIN-Rail and C-Rail applications. These blocks provide a simple depluggable* option for panel wiring applications with the convenience of quick, easy, snap-on installation. Product accessories, such as jumpers and marking tape, are available for most products.

UL E62622
CSA File 15364
CSA File 47235 (15188 Series)

*Not for use as a load break disconnect.

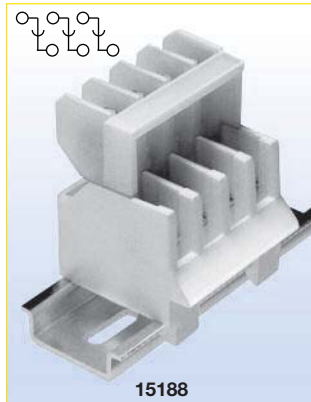



15188



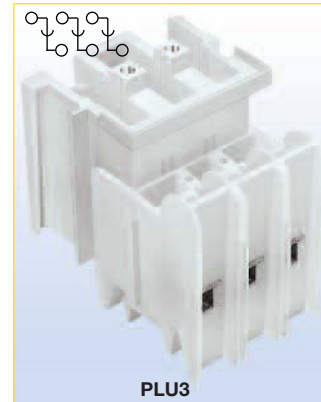

15288





PLU3

Approval  	
Technical Data	
Rated voltage	600V
Rated Current	30A
Center spacing in (mm)	0.375 / 9.52
Conductor cross-section, flexible (AWG/mm ²)	16-12 / 1.5-4
Number of Poles	3 or 4
Circuits per foot	32
Torque(N•m)	1.4
Torque(lb-in)	12
Screw	#6-32
WxHxD(mm)	
3-Pole	30.2 x 49.3 x 47.8
4-Pole	39.2 x 49.3 x 47.8

Colors	Cat. No.
○ White (Standard)	15188-3
○ White (Standard)	15188-4

Approval  	
Technical Data	
Rated voltage	600V
Rated Current	65A
Center spacing in (mm)	0.54 / 13.7
Conductor cross-section, flexible (AWG/mm ²)	16-6 / 1.5-16
Number of Poles	3
Circuits per foot	22
Torque(N•m)	2.3
Torque(lb-in)	20
Screw	#8-32
WxHxD(mm)	
	43.2 x 49.3 x 47.9
	N/A

Colors	Cat. No.
○ White (Standard)	15288

Approval  	
Technical Data	
Rated voltage	600V
Rated Current	40A
Center spacing in (mm)	0.39 / 9.91
Conductor cross-section, flexible (AWG/mm ²)	22-8 / 0.5-10
Number of Poles	3
Circuits per foot	28
Torque(N•m)	2
Torque(lb-in)	18
Screw	#8-32
WxHxD(mm)	
	31.8 x 47.0 x 45.6
	N/A

Colors	Cat. No.
○ White (Standard)	PLU3-WH
● Black	PLU3-BK
● Yellow	PLU3-YE

Block 

Accessories	Cat. No.
2 circuits	15188J-2-J
35mm DIN-Rail	DRL35MML0 DRL35MMHI

Accessories	Cat. No.
35mm DIN-Rail	DRL35MML0 DRL35MMHI

Accessories	Cat. No.
2 circuits	JN3
	MT12-1-2
C-Rail (AL)	NFTA Series
C-Rail (low profile)	NRA Series

Configurable Option	Option	Cat. No.
Reverse Wiring	15188-_R	
Locking	15188-_S	
Reverse; Locking	15188-_RS	

Options offered for both pole lengths

Configurable Option	Option	Cat. No.
Reverse Wiring	15288-R	
Screw Together	15288-ST	
Locking	15288-S	

Options may be combined

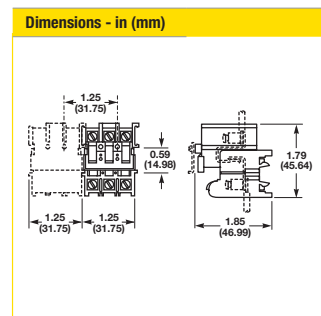
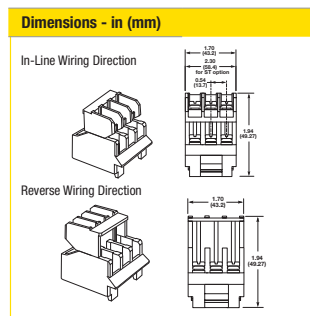
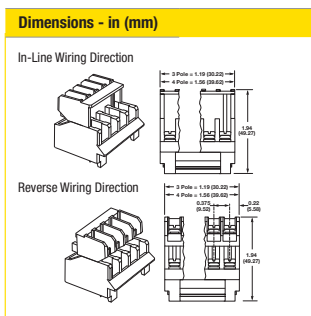

Depluggable Blocks

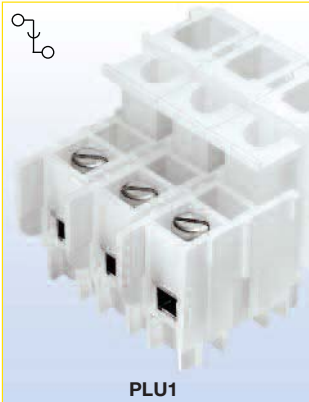

PLU1

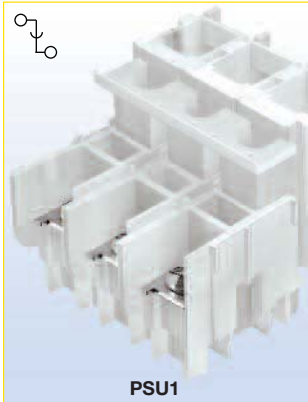

PSU1

Approval 	
Technical Data	
Rated voltage	600V
Rated Current	70A
Center spacing in (mm)	0.625 / 15.88
Conductor cross-section, flexible (AWG/mm ²)	18~4 / 1.0~25
Number of Poles	1 - 3
Circuits per foot	19
Torque(N•m)	3.6
Torque(lb-in)	32
Screw	1/4 - 28
WxHxD(mm)	
1-Pole	18.5 x 47.0 x 45.6
2-Pole	34.0 x 47.0 x 45.6
3-Pole	49.5 x 47.0 x 45.6

Colors	Cat. No.
○ White (1-Pole)	PLU1-WH
○ White (2-Pole)	PLU11-WH
○ White (3-Pole)	PLU111-WH

Accessories	Cat. No.
2 circuits	JN1
	MT12-1-2
C-Rail (AL)	NFTA Series
C-Rail (low profile)	NRA Series

Approval 	
Technical Data	
Rated voltage	600V
Rated Current	45A
Center spacing in (mm)	0.625 / 15.88
Conductor cross-section, flexible (AWG/mm ²)	Ring Terminals Only
Number of Poles	1 - 3
Circuits per foot	19
Torque(N•m)	2.7
Torque(lb-in)	24
Screw	#10-32
WxHxD(mm)	
1-Pole	18.5 x 49.1 x 62.1
2-Pole	34.4 x 49.1 x 62.1
3-Pole	50.3 x 49.1 x 62.1

Colors	Cat. No.
○ White (1-Pole)	PSU1-WH
○ White (2-Pole)	PSU11-WH
○ White (3-Pole)	PSU111-WH

Accessories	Cat. No.
	MT12-1-2
C-Rail (AL)	NFTA Series
C-Rail (low profile)	NRA Series

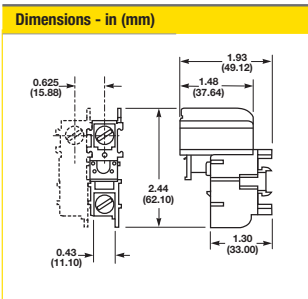
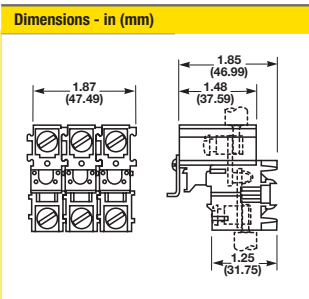

Multi-Pole Panel Mount Blocks



Panel Mount Blocks

Multi-pole panel mount terminal blocks provide a compact, high density circuit connection solution without the necessity of a mounting rail. These products are designed to be nested together to form one string of circuit connections.

UL E62622
CSA 15364 (excluding PLK3)

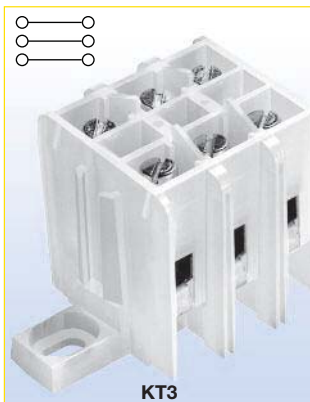

KT3

Approval	
Technical Data	
Rated voltage	600V
Rated Current	40A
Center spacing in (mm)	0.39 / 9.91
Conductor cross-section, flexible (AWG/mm ²)	22-8 / 0.5-10
Number of Poles	3
Circuits per foot	28
Torque(N•m)	2
Torque(lb-in)	18
Screw	#8-32
WxHxD(mm)	59.5 x 31.8 x 31.0

Colors	Cat. No.
○ White (Standard)	KT3-WH
● Black	KT3-BK
● Red	KT3-RE

Accessories	Cat. No.
2 circuits	JN3
	MT12-1-2
Mounting Foot	KAD

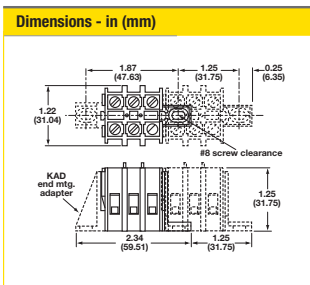

KT4

Approval	
Technical Data	
Rated voltage	600V
Rated Current	30A
Center spacing in (mm)	0.25 / 6.35
Conductor cross-section, flexible (AWG/mm ²)	22-10 / 0.5-6
Number of Poles	4
Circuits per foot	48
Torque(N•m)	2
Torque(lb-in)	18
Screw	#6-32
WxHxD(mm)	43.8 x 34.0 x 32.2

Colors	Cat. No.
○ White*	KT4-WH-A
○ White*	KT4-WH-B
● Black	KT4-BK

Accessories	Cat. No.
4 circuits	JN4
	MTC6

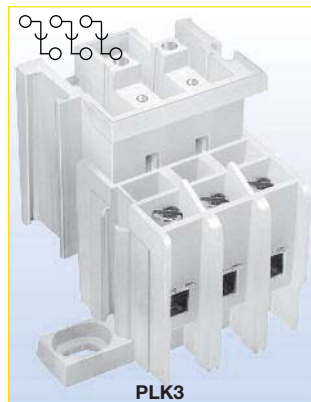
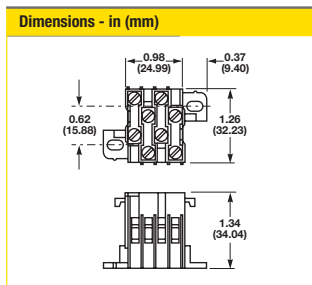

PLK3

Approval	
Technical Data	
Rated voltage	600V
Rated Current	40A
Center spacing in (mm)	0.39 / 9.91
Conductor cross-section, flexible (AWG/mm ²)	22-8 / 0.5-10
Number of Poles	3
Circuits per foot	28
Torque(N•m)	2
Torque(lb-in)	18
Screw	#8-32
WxHxD(mm)	65.7 x 46.9 x 45.5

Colors	Cat. No.
○ White (Standard)	PLK3-WH

Accessories	Cat. No.
2 circuits	JN3
	MT12-1-2
Mounting Foot	KAD

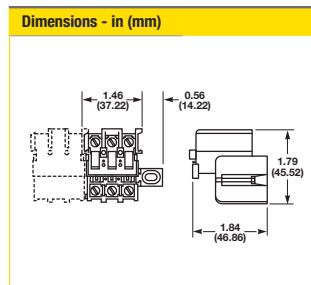

*The KT4 products are designed to be nested together to form one string of circuit connections. When used in series, order

Quick Connect Blocks



Quick Connect Blocks

For a time saving alternative for electrical connections, the Bussmann quick connect terminal blocks offer a convenient solution. With male spade terminals, wire connections are made quickly and simply with these terminal blocks. Products are offered for C-Rail and panel mount applications.

UL E62622
CSA 15364 (excluding NTQ23)



Approval	
Technical Data	
Rated voltage	600V
Rated Current	40A
Center spacing in (mm)	0.39 / 9.91
Conductor cross-section, flexible (AWG/mm ²)	22-8 / 0.5-10
Number of Poles	3
Circuits per foot	28
Torque(N•m)	2
Torque(lb-in)	18
Screw	#8-32
WxHxD(mm)	31.8 x 31.8 x 33.2

Colors	Cat. No.
○ White (Standard)	NTQ23-WH

Accessories	Cat. No.
Marking Tape	MT12-1-2
C-Rail	NFTA Series
C-Rail (low profile)	NRA Series

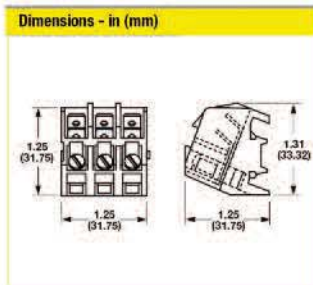

Approval	
Technical Data	
Rated voltage	600V
Rated Current	40A
Center spacing in (mm)	0.437 / 11.1
Conductor cross-section, flexible (AWG/mm ²)	22-8 / 0.5-10
Number of Poles	1
Circuits per foot	24
Torque(N•m)	2
Torque(lb-in)	18
Screw	#8-32
WxHxD(mm)	33.3 x 35.8 x 37.3

Colors	Cat. No.
○ White (Standard)	BNQ21-WH

Accessories	Cat. No.
Mounting Foot	BQE

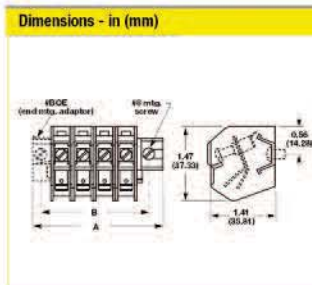

Approval	
Technical Data	
Rated voltage	600V
Rated Current	30A
Center spacing in (mm)	0.437 / 11.1
Conductor cross-section, flexible (AWG/mm ²)	25" Quick Connect Terminals Only
Number of Poles	1
Circuits per foot	24
Torque(N•m)	NA
Torque(lb-in)	NA
Screw	NA
WxHxD(mm)	33.3 x 35.8 x 37.3

Colors	Cat. No.
○ White (Standard)	BQQ41-WH

Accessories	Cat. No.
Mounting Foot	BQE

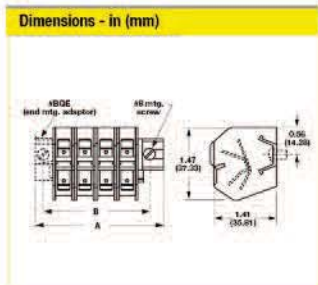

Block



Marking Tape

Mounting

Double Row Terminal Blocks

Series TB100

Specifications

Rating: 30A, 300V*

Center Spacing: 0.375" or 3/8" (9.52mm)

Wire Range: #14 - 22 AWG Cu

Screw Size: #6-32 phillslot screws

Torque Rating: 9 lb-in

Distance Between Barriers: 0.30" (7.62mm)

Mounting: #6 screws

Operating Temperature: 130°C (266°F) max.,
-40°C (-40°F) min.

Materials: Molded base: Black, UL rated 94V0 thermoplastic

Terminal plating: Tin over brass; Screws: Zinc-plated steel

Breakdown Voltage: 3600V

Agency Information: UL File E62622/CSA File 47235; IEC Compliance; CE Certified

* Max rating shown; some options may be rated lower.



TB100-08



TB100-04SP

Dimensions - in

Poles	A	B	Poles	A	B	Poles	A	B
02	1.40	1.12	14	5.90	5.62	26	10.40	10.12
03	1.78	1.50	15	6.28	6.00	27	10.78	10.50
04	2.16	1.88	16	6.66	6.38	28	11.16	10.88
05	2.53	2.25	17	7.03	6.75	29	11.53	11.25
06	2.90	2.62	18	7.40	7.12	30	11.90	11.62
07	3.28	3.00	19	7.78	7.50	31	12.28	12.00
08	3.66	3.38	20	8.16	7.88	32	12.66	12.38
09	4.03	3.75	21	8.53	8.25	33	13.03	12.75
10	4.40	4.12	22	8.90	8.62	34	13.40	13.12
11	4.78	4.50	23	9.28	9.00	35	13.78	13.50
12	5.16	4.88	24	9.66	9.38	36	14.16	13.88
13	5.53	5.25	25	10.03	9.75			

1" = 25.4mm.

TB100- in (mm)

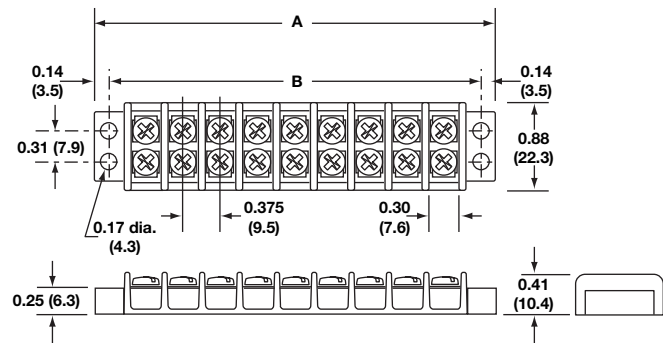

Catalog Number Build-A-Code

Series	Poles	Screw Options	Marking/Cover	Hardware Options
TB100	□ □	□ □ □	□ □	□ □ □ □
	02 to 36	Blank - steel phillslot, zinc-plated 00 - screws shipped bulk B - brass phillslot, nickel-plated SP - steel Sems phillslot, zinc-plated	L1 to L6 Marking Options (See page 318) Marker Strips (See page 319) Special Markings (See page 319) Covers (See page 318)	QC1 to QC20 - quick connects Custom Options** J101 - flat slip-on jumper (2 position only) OJ2 - over barrier jumpers OJ4 - over barrier jumpers

**Contact factory for pole configuration.

Double Row Terminal Blocks

Screw Options



B
Brass Philslot
Nickel-Plated

SP
Steel SEMS
Philslot Zinc-Plated

Hardware Options

Quick Connects – Assembled: Terminals 0.187" x 0.020". Maximum current rating 13 amps. For other orientations, contact Bussmann.

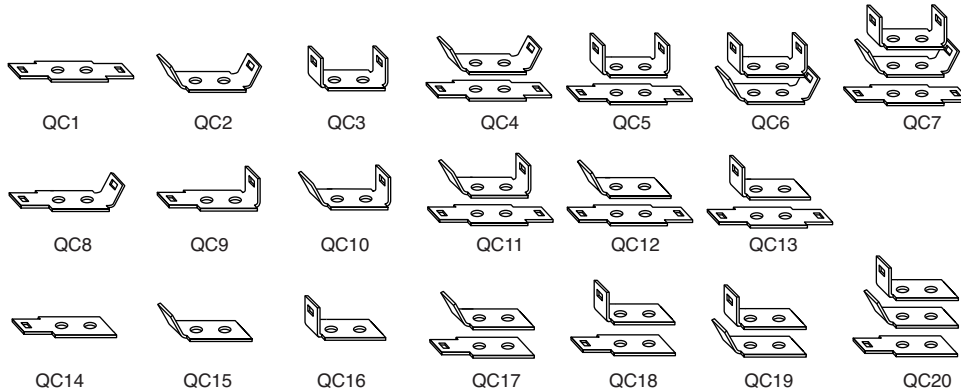

Quick Connects – Bulk: minimum order per part number – 100 pieces.

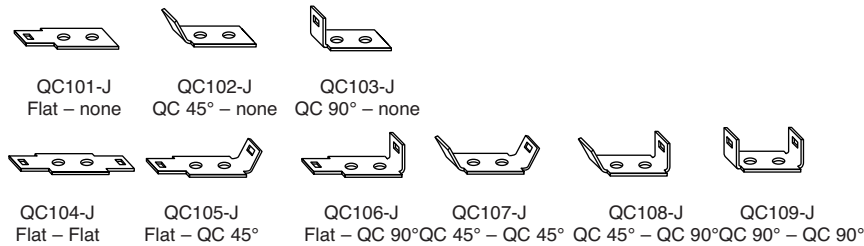

Jumpers – Bulk: minimum order per part number – 100 pieces. Contact Bussmann for jumper assembly.

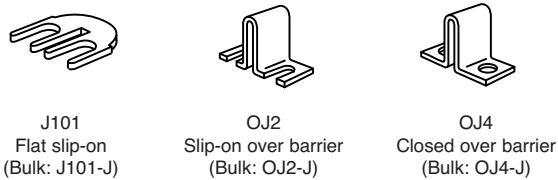

J101
Flat slip-on
(Bulk: J101-J)

OJ2
Slip-on over barrier
(Bulk: OJ2-J)

OJ4
Closed over barrier
(Bulk: OJ4-J)

Double Row Terminal Blocks

Series TB200 & TB200HB

Specifications

Ratings:

- Volts: — 300V* (TB200)
- 600V* (TB200HB)

Amps: — 30A*

Center Spacing: 0.437" or 7/16" (11.10mm)

Wire Range: #12 - 22 AWG Cu

Screw Size: #6-32 philslot screws

Torque Rating: 9 lb-in

Distance Between Barriers: 0.353" (8.97mm)

Mounting: #6 screws

Operating Temperature: 130°C (266°F) max., -40°C (-40°F) min.

Materials: Molded base: Black, UL rated 94V0 thermoplastic

Terminal plating: Tin over brass; Screws: Zinc-plated steel

Breakdown Voltage: 4800V

Agency Information: UL File E62622, CSA File 47235 & 15364; IEC Compliance; CE Certified

* Max rating shown; some options may be rated lower.

Dimensions - in

Poles	A	B	Poles	A	B	Poles	A	B
02	1.63	1.31	12	6.00	5.68	22	10.37	10.06
03	2.07	1.75	13	6.44	6.12	23	10.81	10.50
04	2.51	2.18	14	6.87	6.56	24	11.25	10.93
05	2.94	2.62	15	7.31	7.00	25	11.68	11.37
06	3.38	3.06	16	7.75	7.43	26	12.12	11.81
07	3.82	3.50	17	8.19	7.87	27	12.56	12.25
08	4.25	3.93	18	8.62	8.31	28	13.00	12.68
09	4.69	4.37	19	9.06	8.75	29	13.44	13.12
10	5.13	4.81	20	9.50	9.18	30	13.87	13.56
11	5.57	5.25	21	9.94	9.62			

1" = 25.4mm.



TB200-10SP



TB200HB-06

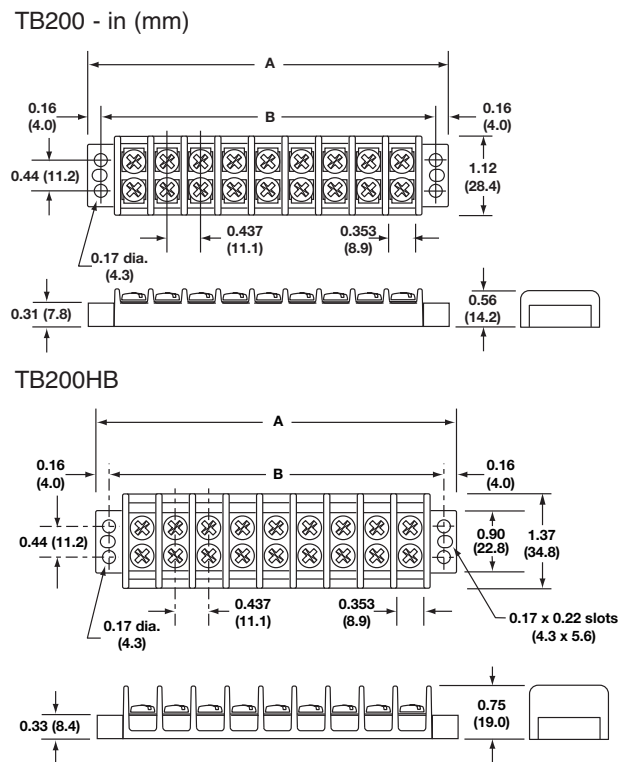







Catalog Number Build-A-Code

Series	Poles	Screw Options	Marking/Cover	Hardware Options
TB <input type="checkbox"/> <input type="checkbox"/> <input type="checkbox"/> <input type="checkbox"/> <input type="checkbox"/> <input type="checkbox"/> - <input type="checkbox"/> <input type="checkbox"/>	<input type="checkbox"/> <input type="checkbox"/> <input type="checkbox"/> <input type="checkbox"/> <input type="checkbox"/> <input type="checkbox"/> <input type="checkbox"/> <input type="checkbox"/> <input type="checkbox"/> <input type="checkbox"/> <input type="checkbox"/> <input type="checkbox"/> <input type="checkbox"/> <input type="checkbox"/> <input type="checkbox"/> <input type="checkbox"/> <input type="checkbox"/> <input type="checkbox"/> <input type="checkbox"/>	<input type="checkbox"/> <input type="checkbox"/> <input type="checkbox"/>	<input type="checkbox"/> <input type="checkbox"/>	<input type="checkbox"/> <input type="checkbox"/> <input type="checkbox"/> <input type="checkbox"/>
200 - Standard	02 to 30	Blank - Steel philslot, zinc-plated	L1 to L6 - Marking Options (See page 318)	QC1 to QC20 - Quick connects
200HB - High barrier		00 - Screws shipped bulk	Special Markings (See page 318)	
		B - Brass philslot, nickel-plated	Covers (See page 318)	
		BS - Brass Sems philslot, nickel-plated	Marking Strips (See page 319)	
		SP - Steel Sems philslot, zinc-plated		Custom Options**
		P - Steel Sems (P-style)		J201 - Flat slip-on jumper (2 position only)
		ST - Stainless steel, philslot		OJ3 - Over barrier jumpers
		SS - Stainless steel Sems, philslot		OJ5 - Over barrier jumpers
				OJ7 - Over barrier jumpers

**Contact factory for pole configuration

Double Row Terminal Blocks

Screw Options

					
B Brass Philslot Nickel-Plated Bulk: B001-7016-J	BS Brass SEMS Philslot Nickel-Plated B001-7019-J	SP Steel SEMS Philslot Zinc-Plated B001-7007-J	P Steel SEMS (P-Style) B001-7000-J	ST Stainless Steel Philslot F507-J	SS Stainless Steel SEMS Philslot B001-7085-J

Hardware Options

Quick Connects – Assembled: Terminals 0.25" x 0.031". Maximum current rating 20 amps. For other orientations, contact Bussmann.

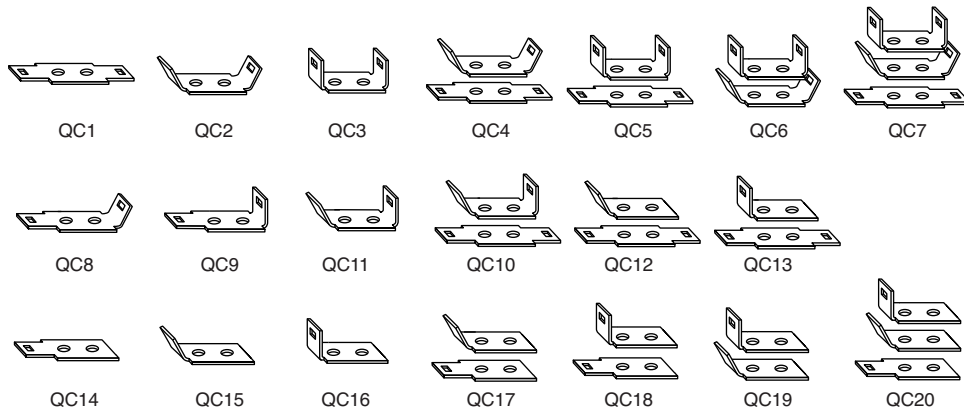

Quick Connects – Bulk: minimum order per part no. – 100 pieces.

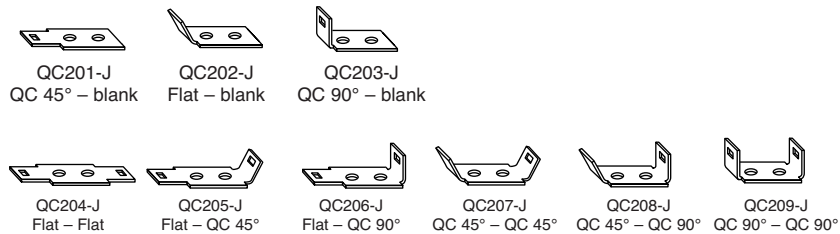

Jumpers – Bulk: minimum. order per part no. – 100 pieces. Contact Bussmann for jumper assembly.

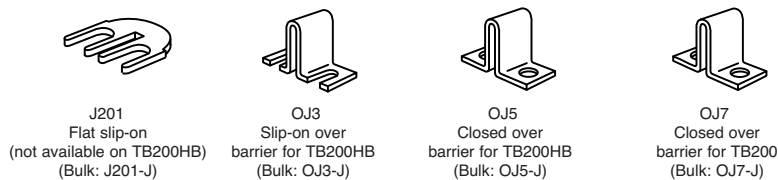

Double Row Terminal Blocks

Series TB300 & TB345

Specifications

Ratings:

- Volts: — 600V*
- Amps: — 30A* (TB300)
- 45A (TB345)

Center Spacing: 0.562" or 9/16" (14.28mm)

Wire Range: #8 - 22 AWG Cu

Screw Size: TB300 – #8-32 philslot screws
TB345 – #10-32 philslot screws

Torque Rating: #8 screws - 16 lb-in;
#10 screws - 20 lb-in

Distance Between Barriers: 0.41" (10.5mm)

Mounting: TB300 – #8 screws; TB345 – #10 screws

Operating Temperature: 130°C (266°F) max., -40°C (-40°F) min.

Material: Molded base: Black, UL rated 94V0 thermoplastic
Terminal plating: Tin over brass; Screws: Zinc-plated steel

Breakdown Voltage: 7500V

Agency Information: UL File E62622, CSA File 47235; IEC Compliance; CE Certified

* Max rating shown; some options may be rated lower.

Dimensions - in

Poles	A	B	Poles	A	B	Poles	A	B
02	2.13	1.69	10	6.62	6.19	18	11.12	10.68
03	2.69	2.25	11	7.18	6.75	19	11.68	11.25
04	3.25	2.81	12	7.75	7.31	20	12.24	11.81
05	3.81	3.37	13	8.31	7.87	21	12.80	12.37
06	4.37	3.94	14	8.87	8.44	22	13.37	12.93
07	4.94	4.50	15	9.43	9.00	23	13.93	13.50
08	5.50	5.06	16	9.99	9.56	24	14.49	14.06
09	6.06	5.62	17	10.56	10.12			

1" = 25.4mm.



TB300 & TB345 - in (mm)

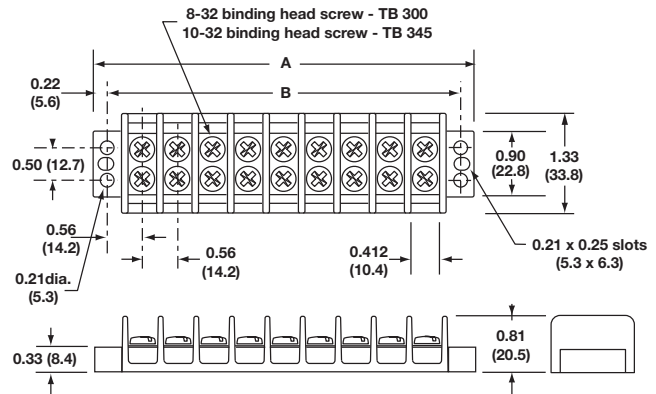

Catalog Number Build-A-Code

Series	Poles	Screw Options	Marking/Cover	Hardware Options
TB <input type="checkbox"/> <input type="checkbox"/> <input type="checkbox"/> - <input type="checkbox"/> <input type="checkbox"/>	<input type="checkbox"/> <input type="checkbox"/> <input type="checkbox"/>	<input type="checkbox"/> <input type="checkbox"/> <input type="checkbox"/>	<input type="checkbox"/> <input type="checkbox"/>	<input type="checkbox"/> <input type="checkbox"/> <input type="checkbox"/> <input type="checkbox"/>
300 = 8-32 screw 345 = 10-32 screw	02 to 24	Blank = Steel philslot, zinc-plated 00 = Screws shipped bulk B = Brass philslot, nickel-plated BS = Brass Sems philslot, nickel-plated (TB300 only) SP = Steel Sems philslot, zinc-plated (TB300 only) ST = Stainless steel, philslot	L1 to L6 Marking Options (pg 318) Special Markings (pg 318) Covers (pg 318) Marking Strips (pg 319)	QC1 to QC20 = Quick connects (TB300 only)
				Custom Options J301 = Flat slip-on jumper OJ6 = Over barrier jumper OJ11 = Over barrier jumper

Double Row Terminal Blocks

Screw Options



B
Brass Philslot
Nickel-Plated
B001-7018-J
B500-023-028-J



BS
Brass SEMS
Philslot Nickel-Plated
B001-7015-J



SP
Steel SEMS
Philslot Zinc-Plated
B001-7017-J



ST
Stainless Steel
Philslot
B001-7063-J
B001-7064-J

TB300 Blk:
TB345 Blk:

Hardware Options

Quick Connects – Assembled: TB300 only. Terminals 0.25" x 0.031". Maximum current rating 20 amps. For other orientations, contact Bussmann.

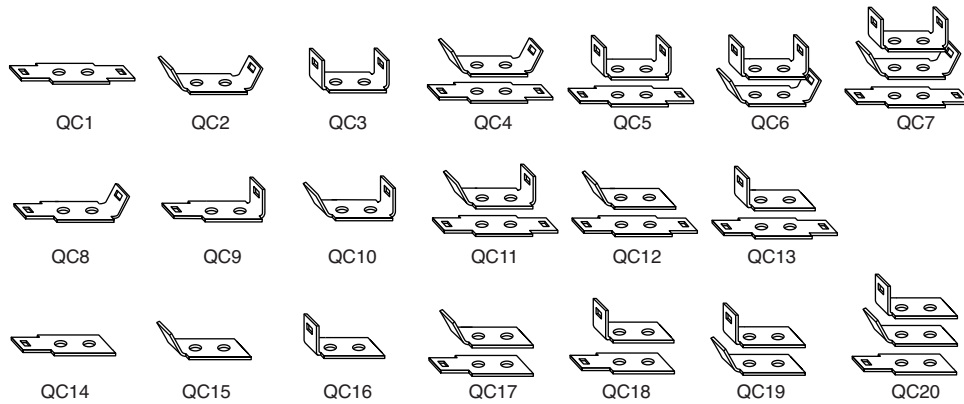

Quick Connects – Bulk: (*TB300 only) minimum order per part number. – 100 pieces.

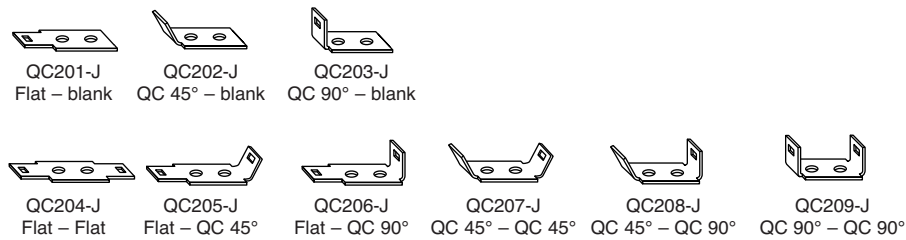

Jumpers – Bulk: minimum order per part number – 100 pieces. Contact Bussmann for jumper assembly.



J301
Flat slip-on(TB300 only)
(Bulk: J301-J)

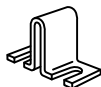

OJ6
Closed over barrier
(Bulk: OJ6-J)

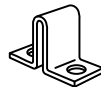

OJ11
Slip-on over barrier
(Bulk: OJ11-J)

Marking Options and Covers for Double Row Terminal Blocks

Standard Marking

Standard markings are applied directly to the side(s) of a block. The standard marking color is white. The standard numeral height is 0.125 inches (3.17mm).

Note: Blocks marked on both sides require a different code for each side. Example: Style L1 on one side of the block requires Style L2 on the other side to ensure common terminal marking. To order, add appropriate suffix (L1, L2, L3, L4, L5 and/or L6) to block catalog number in the proper sequence.

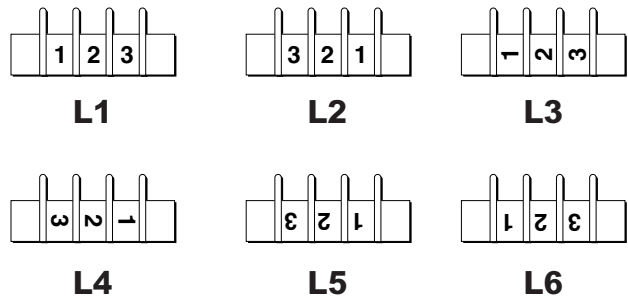

Special Marking

Special markings are available at an additional charge. Drawing(s) must be submitted to ensure accuracy of part required. Consult Bussmann for price and delivery.

Note: Marking is not available on TB400 Series

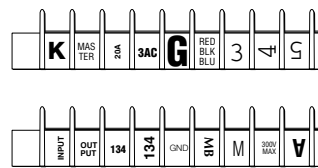

Covers

Covers prevent personnel, screws and foreign items from contacting live terminals, and are available in white or clear plastic. Two cover clips are supplied with each cover. The cover width is 1.31 inches (33.3mm).

All covers must be ordered separately.

Example: 10 position cover, white, TB100 Series = Catalog Number **X12010**.

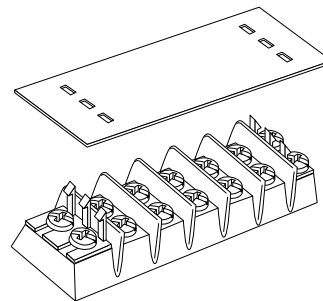

Catalog Number Build-A-Code

Series	Cover Strip	Poles	High Barrier Option Only
x	<input type="checkbox"/> <input type="checkbox"/> <input type="checkbox"/>	<input type="checkbox"/> <input type="checkbox"/>	<input type="checkbox"/> <input type="checkbox"/>
	120 - TB100/white 119 - TB100/clear 220 - TB200/TB200HB - white 219 - TB200/TB200HB - clear 320 - TB300 & TB345 - white 319 - TB300 & TB345 - clear	02 to 36 (TB100) 02 to 30 (TB200/TB200HB) 02 to 24 (TB300/TB345)	HB = High Barrier

Note: Covers are not available on TB400 Series.

Cover Clips – Bulk

Part Number

- DD1-J – TB100 Series
- DD2-J – TB200 Series
- DD2HB-J – TB200HB Series
- DD3-J – TB300 Series

Top & Bottom Marking Strips for Double Row Terminal Blocks

Top Marker Strips

Top mounting marker strips are available in white (opaque) plastic. Two cover clips are supplied with each marker strip.

All top marker strips must be ordered separately.

Example: 12 position cover, TB200, 0.032" x 0.312" = Catalog Number **X20312**.

Example: 12 position cover, TB200HB, 0.06" x 0.50" = Catalog Number **X23312HB**.

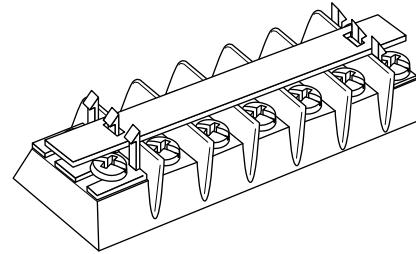

Catalog Number Build-A-Code

Series	Top Marker Strip	Poles	High Barrier Option Only
X	<input type="checkbox"/> <input type="checkbox"/> <input type="checkbox"/>	<input type="checkbox"/> <input type="checkbox"/>	<input type="checkbox"/> <input type="checkbox"/>
	133 - TB100 (0.060 thk x 0.500 w)	02 to 36 (TB100)	HB = High Barrier
	103 - TB100 (0.032 thk x 0.312 w)	02 to 30 (TB200/TB200HB)	
	233 - TB200/TB200HB (0.060 thk x 0.500 w)	02 to 24 (TB300/TB345)	
	203 - TB200/TB200HB (0.032 thk x 0.312 w)		
	333 - TB300 & TB345 (0.060 thk x 0.500 w)		
	303 - TB300 & TB345 (0.032 thk x 0.380 w)		

Note: Marking Strips are not available on TB400 Series

Bottom Marker Strips

Bottom mounting marker strips are made of black PVC, 0.030" thick. Space is available to handle most marking situations. All marker strips must be ordered separately.

To order, specify part number and required marking orientation: (BF) bottom forward, (BR) bottom reverse, (TF) top forward, or (TR) top reverse. Consult factory for specials.

Example: 13 position strip, TB100 with no markings, space for marking one side = Catalog Number **X10513**.

Standard numeral height is 0.125". Standard markings are 0-99. Special markings are available on special order. Drawing(s) must be submitted to ensure accuracy of part required.

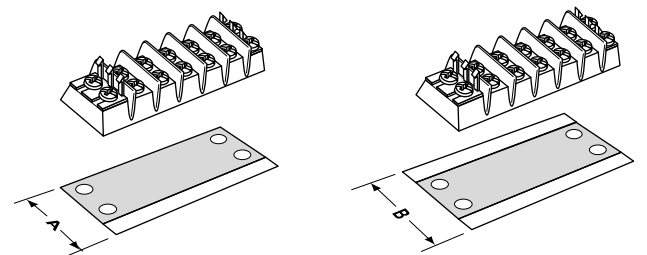

Space for marking one side

Space for marking two sides

Dimensions (in)

Dim.	TB100	TB200	TB200HB	TB300	TB345	TB400
A	1.13	1.37	1.62	1.58	1.58	N/A
B	1.38	1.62	1.81	1.81	1.81	N/A

Catalog Number Build-A-Code

Series	Bottom Marker Strip	Poles	Orientation
X	<input type="checkbox"/> <input type="checkbox"/> <input type="checkbox"/>	<input type="checkbox"/> <input type="checkbox"/>	<input type="checkbox"/> <input type="checkbox"/>
	105 = TB100/markings one side	02 to 36 (TB100)	BF = Bottom forward
	101 = TB100/markings both sides	02 to 30 (TB200/TB200HB)	BR = Bottom reverse
	205 = TB200/markings one side	02 to 24 (TB300/TB345)	TF = Top forward
	201 = TB200/markings both sides		TR = Top reverse
	295 = TB200HB/markings one side		
	291 = TB200HB/markings both sides		
	305 = TB300 & TB345/markings one side		
	301 = TB300 & TB345/markings both sides		

Note: Marking Strips are not available on TB400 Series.

Double Row Terminal Blocks

Series TB400

Specifications

Ratings:

- Volts: — 600V
- Amps: — 75A
- Center Spacing:** 0.687" or 11/16" (17.45mm)
- Wire Range:** #6-14 AWG Cu
- Screw Size:** #10-32 philslot screws
- Torque Rating:** 20 lb-in
- Distance Between Barriers:** 0.56" (14.3mm)
- Mounting:** #10 screws
- Operating Temperature:** 130°C (266°F) max., -40°C (-40°F) min.

Material: Molded base: Black, UL rated 94V0 thermoplastic
Terminal plating: Tin over brass; Screws: Zinc-plated steel

Breakdown Voltage: 7500V

Agency Information: UL File E62622, CSA File 47235; IEC Compliance; CE Certified

Dimensions - in

Poles	A	B	Poles	A	B	Poles	A	B
02	2.51	2.06	06	5.26	4.81	10	8.01	7.56
03	3.20	2.75	07	5.95	5.50	11	8.70	8.25
04	3.89	3.44	08	6.64	6.19	12	9.39	8.94
05	4.58	4.13	09	7.33	6.88			

1" = 25.4mm.

Screw Options



B

Brass Philslot
Nickel-Plated

Bulk: B500-023-028-J

ST

Stainless Steel
Philslot

Bulk: B001-7064-J

Hardware Options



OJ14: Closed over barrier
(Bulk: OJ14-J)

Catalog Number Build-A-Code

Series	Poles	Screw Options	Marking	Custom Options
TB400	- <input type="checkbox"/> <input type="checkbox"/>	<input type="checkbox"/> <input type="checkbox"/> <input type="checkbox"/>		
	02 to 12	Blank = Steel philslot, zinc-plated 00 = Screws shipped bulk B = Brass philslot, nickel-plated ST = Stainless steel, philslot	Not available	OJ14* - Jumper over barrier

*Contact factory for pole configuration.

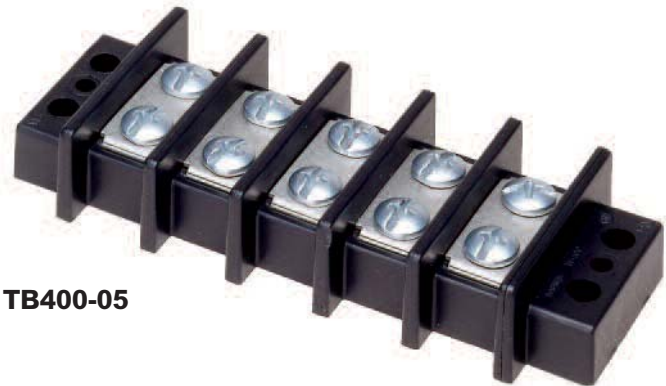

TB400-05

TB400 - in (mm)

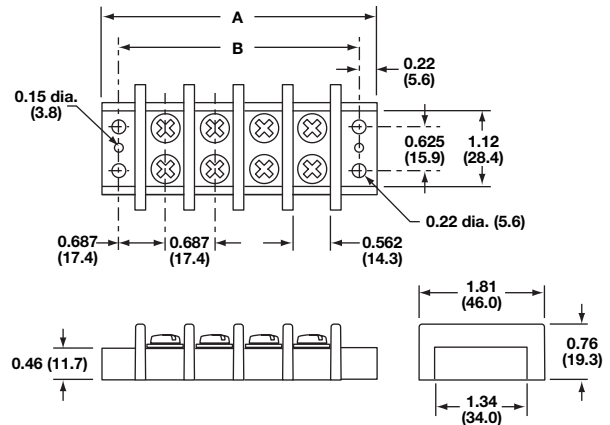

Double Row Terminal Blocks

Series KU

Specifications

Ratings:

Volts: — 600V

Amps: — 60A*

Center Spacing: 0.625" (15.88mm)

Number of Poles: 2- to 12-poles**

Wire Range: #6-22 AWG Cu

Screw Size: #10-32

Torque Rating: 20 lb-in

Distance Between Barriers: 0.437" (11.09mm)

Mounting: Panel Mount

Material: Molded base: Black, UL rated 94V1 Noryl

Terminal plating: Nickel over brass

Operating Temperature: 105°C max.

Agency Information: UL File E62622, CSA File 47235

* 60A rating achieved with #6 copper wire crimped to ring terminal.

** Only even number pole configurations (3-pole = exception).

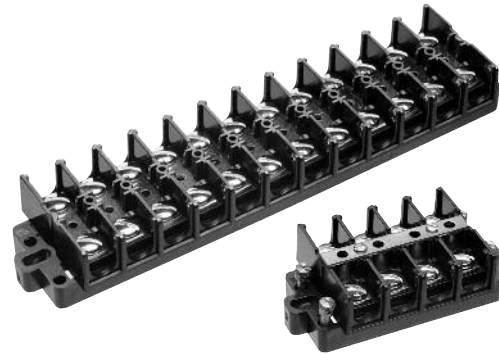

Series KU - in (mm)

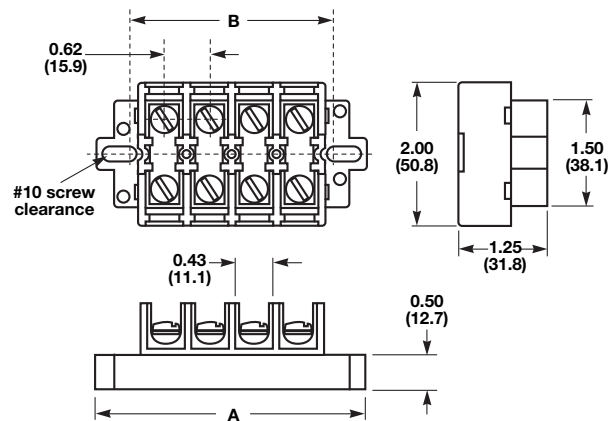

Dimensions - in

Poles	KU		KUX Only
	A	B	A
02	2.50	1.62	2.00
03	3.12	2.25	2.62
04	3.75	2.87	3.25
06	5.00	4.12	4.50
08	6.25	5.37	5.75
10	7.50	6.62	7.00
12	8.75	7.87	8.25

1" = 25.4mm.

Accessories***

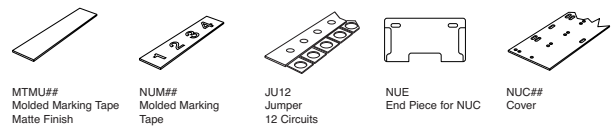

***Accessories must be ordered separately.

Catalog Number Build-A-Code - KU Series

Series	Poles	Screw Options	Covers	Marking Strip
□ □ □ □ □	□ □ - □ □		□ □	□ □ □
KU = Standard block	02 to 12	00 = Screws shipped bulk	WC = Top cover & 2 end plates	MT = Matte finish
KUX = Short block		W = Brass washer head, nickel-plated		NU = Numbered 1 to 12, horizontal
KURL = Standard w/removable link		P = Steel screw w/pressure plate zinc-plated		NUV = Numbered 1 to 12, vertical
KUXRL = Short block w/removable link		BP = Brass phillslot, nickel-plated		PT† = Marker strip for cover

Catalog Number Build-A-Code - KU_SC Series

Series	Poles	Screw Options	Covers	Marking Strip
□ □ □ □ □	□ □ - □ □		□ □	□ □ □
KUSC = Standard w/shorting strap & 4 shorting screws	02 to 12	00 = Screws shipped bulk	WC = Top cover & 2 end plates	PT† = Marker strip for cover
KUXSC = Short block w/shorting strap & 4 Shorting screws		W = Brass washer head, nickel-plated		
		P = Steel screw w/pressure plate zinc-plated		
		BP = Brass phillslot, nickel-plated		

†Requires WC cover option

Power Feed Through Terminal Blocks

Series C7021

Specifications

Description: Power feed through terminal block with two rows 1/4-20 studs capable of accommodating the industry standard two-hole compression lugs on both studs in parallel.



Ratings:

Volts: — 300V
 Amps: — 115/175A* per pole
Center Spacing: 0.690" (17.5mm).
Wire Range: AWG #3/0-8.

Poles: 1- to 6-poles.

Bolt Hole Spacing: 0.625" or 5/8" (15.88mm).

Stud: Standard 1/4-20 stud (tin-plated brass) or optional M6 stud.

Mounting: #6 thread cutting screws (not included) or optional mounting ears.

Torque Rating: 36 lb-in.

Operating Temperature: 130°C.

Agency Information: UL/CSA; CE Certified.

*175 achieved using both studs in parallel, 115A using a single stud per line.

Typical Applications

- Applications requiring up to 175A utilizing a 2-hole compression lug on 5/8" centers
- Input/output block for telecommunications power panels
- Use to eliminate busbars

Dimensions - mm (in)

Catalog Numbers	A	B	C	D	E
C7021-01-X					
C7021-02-X	17.5 (0.69)	-	54.4 (2.14)	67.3 (2.65)	31.8 (1.25)
C7021-03-X	34.9 (1.37)	-	70.9 (2.83)	84.8 (3.34)	49.2 (1.94)
C7021-04-X	52.3 (2.06)	-	89.3 (3.52)	102.2 (4.02)	66.7 (2.63)
C7021-05-X	69.8 (2.75)	-	106.8 (4.20)	119.7 (4.71)	84.2 (3.31)
C7021-06-X	87.2 (3.44)	-	124.2 (4.89)	134.1 (5.40)	101.7 (4.00)
C7021-01N-X					
C7021-02N-X	17.5 (0.69)	36.1 (1.42)	-	-	31.8 (1.25)
C7021-03N-X	34.9 (0.69)	53.5 (2.11)	-	-	49.2 (1.94)
C7021-04N-X	52.3 (2.06)	71.0 (2.80)	-	-	66.7 (2.63)
C7021-05N-X	69.8 (2.75)	88.4 (3.48)	-	-	84.2 (3.31)
C7021-06N-X	87.2 (3.44)	105.9 (4.17)	-	-	101.7 (4.00)

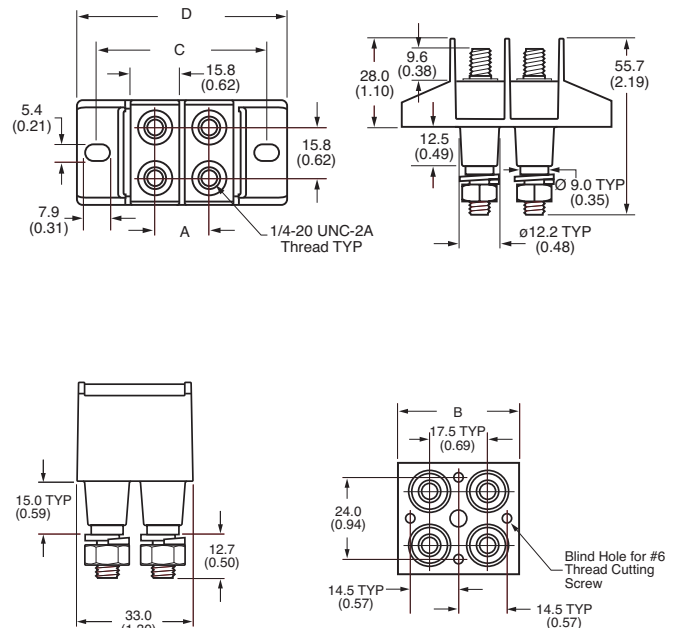

Panel Cutouts

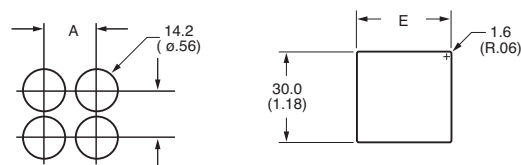

Catalog Number Build-A-Code

Series	Poles	Mount Ends	Studs	Hardware
C7021	- □ □	□	□ □	- □
	01 = 1-Pole (2 studs) 02 = 2-Pole (4 studs) 03 = 3-Pole (6 studs) 04 = 4-Pole (8 studs) 05 = 5-Pole (10 studs) 06 = 6-Pole (12 studs)	Blank = Mount ends N = No mount ends	Blank = Standard M6 = M6 Studs	Blank = No hardware 0 = Bulk pack, one set 1 = Bulk pack, two sets 2 = Assembled, bottom 3 = Assembled, top 4 = Assembled, both sets

Power Feed Through Terminal Blocks

Series C7024

Specifications

Description: A power feed through terminal block with two rows of ¼-28 studs capable of accommodating the industry standard two-hole compression lugs on ¾" centers.

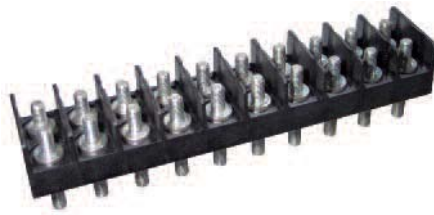

Ratings:

- Volts: — 600V
- Amps: — 115A per pole
- Center Spacing:** 0.75" (19.1mm).
- Wire Range:** #2-8 AWG.
- Poles:** 1 to 12.
- Bolt Hole Spacing:** 0.75" (19.1mm).
- Stud:** Standard ¼-28 stud (tin-plated bronze).
- Torque Rating:** 36 lb-in.
- Operating Temperature:** 130°C.
- Agency Information:** UL/C-UL, CSA; CE Certified.
- Flammability Rating:** UL 94V0.

Catalog Numbers

Catalog Number	Poles	"A" Dimension- mm (in) ±0.4 (±0.02)	"B" Dimension- mm (in)
C7024-01	01	21.6 (0.85)	-
C7024-02	02	40.6 (1.60)	19.05 ±0.08 (0.750 ±0.003)
C7024-03	03	59.7 (2.35)	38.10 (1.500)
C7024-04	04	78.7 (3.10)	57.15 ±0.26 (2.250 ±0.010)
C7024-05	05	97.8 (3.85)	76.2 (3.00)
C7024-06	06	116.8 (4.60)	95.25 ±0.26 (3.750 ±0.010)
C7024-07	07	135.9 (5.35)	114.30 ±0.38 (5.250 ±0/015)
C7024-08	08	154.9 (6.10)	133.35 ±0.38 (5.25 ±0.015)
C7024-09	09	174.0 (6.85)	152.40 ±0.38 (6.00 ±0.015)
C7024-10	10	193.0 (7.60)	171.45 ±0.38 (6.750 ±0.015)
C7024-11	11	212.1 (8.35)	190.50 ±0.38 (7.500 ±0.015)
C7024-12	12	231.1 (9.10)	209.55 ±0.38 (8.250 ±0.015)

Catalog Number Build-A-Code

Series Poles _____
 C7024 -
 01-12

Typical Applications

- Applications requiring up to 115A utilizing a 2-hole compression lug on ¾" centers
- Ideal as an input/output block for telecommunications power panels
- Use to eliminate busbars

Dimensions - mm (in)

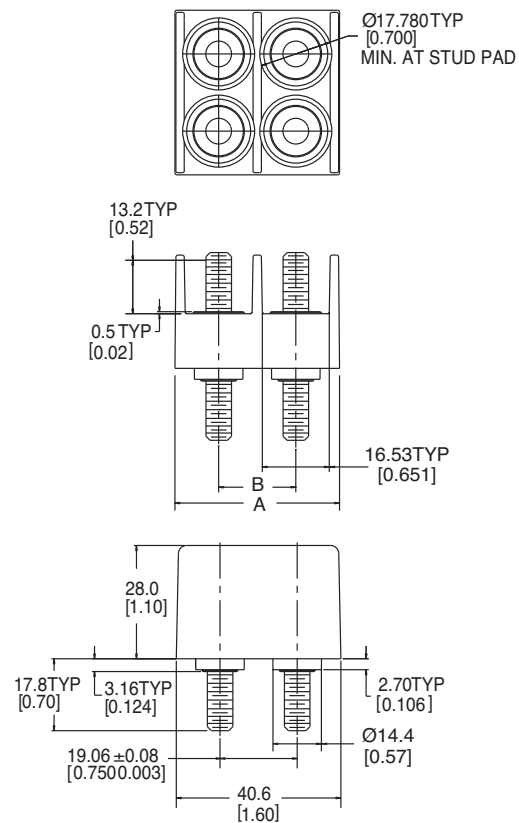

Open and enclosed disconnect switches

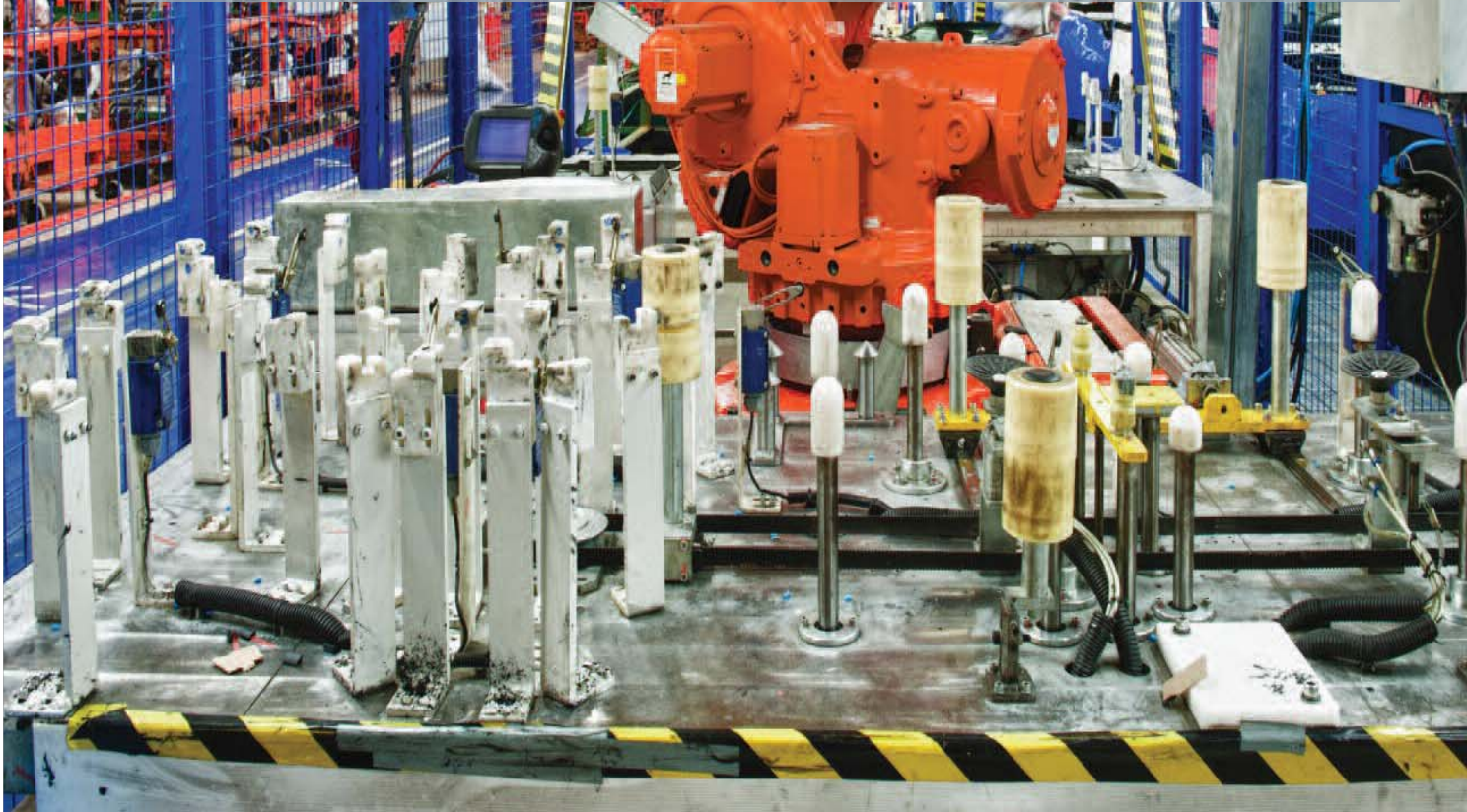

Full range of disconnect switches with versatile options and accessories that ship within 24 hours

Bussmann
by **EAT•N**



Scan this tag to get the latest product information for the New Family of Disconnect Switches and Accessories.



Disconnect Switches

Section Contents

	Page
Compact Circuit Protector (CCP) disconnect switches	
30A Class CC, Midget & 10x38	380-381
30A 60A and 100A Class CF	382-383
CCPB - Compact Circuit Protector Base	384-385
UL 98 fused disconnect switches 30 to 800A	
Introduction & Agency Information.....	386
Product Line Summary.....	387
30A Compact Class CC & Class J	388-389
30A Class J.....	390-391
60A Compact Class J	392-393
60A Class J.....	394-395
100A Class J.....	396-397
200A & 400A Class J	398-400
600A Class J and 800A Class L	402-403
UL 98 non-fused disconnect switches 30 to 1200A	
Introduction & Agency Information.....	404
Product Line Summary.....	405
30A, 60A and 100A Compact	406-407
100A, 200A and 400A Standard	408-409
600A, 800A, 1000A and 1200A Standard.....	410-411
UL 508 non-fused disconnect switches 16 to 80A	
Introduction and Agency Information.....	412
Product Line Summary.....	413
16A, 25A, 40A, 63A and 80A Standard	414-416
Enclosed UL 98 & UL 508 disconnect switches	
Introduction & Agency Information.....	417
Fused UL 98	
30A to 800A Enclosed Disconnects	418-419
Non-Fused UL 98	
30 to 1200A Enclosed Disconnects.....	420-421
Non-Fused UL 508	
16 to 80A Enclosed Disconnects.....	422-423
Fused, dead front disconnect switches	424

Compact Circuit Protector (CCP) Disconnect Switch—30A

1-, 2- & 3-Pole, Class CC, UL Midget & 10x38mm IEC



Switch											
Amp Rating	Fuse Class	Number of Poles	Volts	SCCR	Max Horsepower Rating				Wire Size	Wire Type*	Part Number
					120 Vac	240 Vac	480 Vac	600 Vac			
30	CC	1	600Vac	200kA	0.5	—	—	—	Single/Dual #18-6 Sol/Str	75°C Cu	CCP-1-30CC
30	CC	2	600Vac	200kA	—	2	—	—		75°C Cu	CCP-2-30CC
30	CC	3	600Vac	200kA	—	3	4	7.5		75°C Cu	CCP-3-30CC
30	UL Midget	1	240Vac†	10kA†	—	—	—	—	Single #4 Sol/Str	75°C Cu	CCP-1-30M
32**	10x38 IEC		400Vac†	120kA†							
30	UL Midget	2	240Vac†	10kA†	—	—	—	—		75°C Cu	CCP-2-30M
32**	10x38 IEC		400Vac†	120kA†							
30	UL Midget	3	240Vac†	10kA†	—	—	—	—	Spade Terminal††	75°C Cu	CCP-3-30M
32**	10x38 IEC		400Vac†	120kA†							
30	CC	1	80Vdc†	20kA†	—	—	—	—		75°C Cu	CCP-1-30DCC
30	CC	1	80Vdc†	10kA†	—	—	—	—		75°C Cu	CCP-1-30DCM

* 75°C or higher.
 ** 32A Class aM, 25A Class gG.
 † SCCR May be lower, refer to installed fuse data sheets.
 †† Spade terminal, 30A max, insulated flange, wire size #12-10 for #8 stud.

Specifications

Agency Information

- CE Compliant
- RoHS Compliant
- For **Class CC** fuse version
 - UL 98 Listed, File E302370, Guide WHTY
 - cULus to CSA Standard 22.2 No. 4-04, File 302370, Guide WHTY7
- For **UL Midget and 10X38 IEC** fuse version
 - UL 508 Listed, File E161278, Guide 8R29
 - cULus Certified 22.2 No. 14-05
 - IEC 60947-3 AC23A
 - IEC 60947-3 DC23A

Terminals

- Single/dual conductor box lug or spade terminal suitable for line, load or accessory connection
- Torque: - #18-10 20Lb-In
 - #8-4 35Lb-In

Storage and Operating Temperature

- -20°C to 75°C*
- * For fuse performance under or above 25°C, consult fuse performance derating charts in the Bussmann publication titled *Selecting Protective Devices (SPD)*, reorder #3002.

Flammability Rating UL 94V0

Lockout/Tagout Provisions

- 4mm shank lock or standard pin-out devices

Mounting

- 35mm DIN-Rail

Local Open Fuse Indication Minimum Voltage**

- 90Vac for AC versions
- 12Vdc for DC versions

** Circuit must be closed for indication light to illuminate.

Features

- IP20 Finger-safe construction with #10 or larger wire
- Switch interlock prohibits removing the fuse under load

Accessories

- Auxiliary contacts
- PLC Wired remote fuse indication

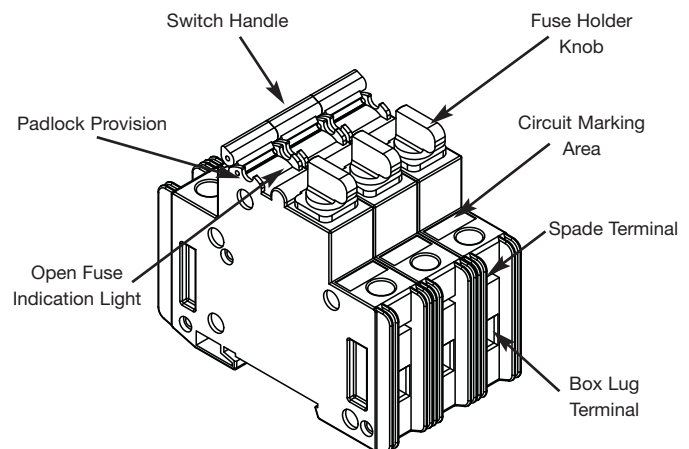

Available Bussmann Fuses

Class	Type	Data Sheet #
CC	LP-CC Time-Delay, Current Limiting	1023
CC	FNQ-R Time-Delay	1014
CC	KTK-R Fast-Acting	1015
M	FNM Time-Delay	2028
M	FNQ Time-Delay	1012
M	KTK Fast-Acting	1011
M	BAF Fast-Acting	2011
M	KLM Fast-Acting 600Vac/dc	2020

Data Sheet: 1157

Compact Circuit Protector (CCP) Disconnect Switch—30A 1-, 2- & 3-Pole, Class CC, UL Midget & 10x38mm IEC

Dimensions – mm (in)

Class CC, UL Midget & 10x38 IEC

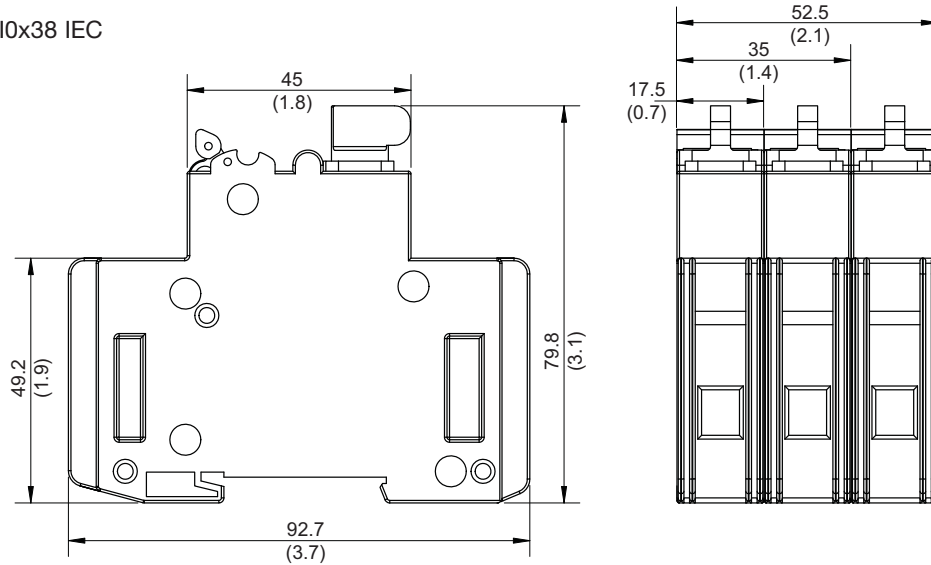

Disconnect
Switches

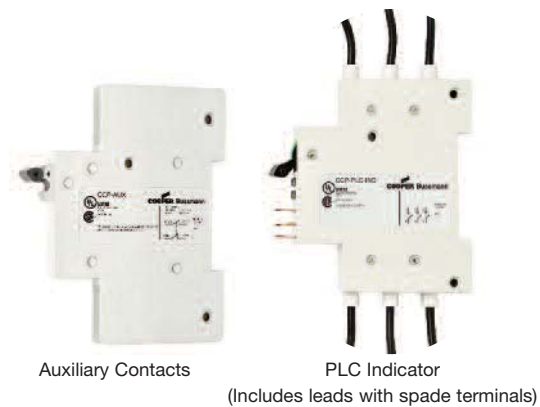

Auxiliary Contacts

PLC Indicator
(Includes leads with spade terminals)

CCP-30 Accessories					
Description	Configuration	Signal Output	Minimum Circuit Voltage	Agency Information	Part Number
Auxiliary Contacts NO+NC for Switch Status	1 per CCP	5A/240Vac	–	UL 98 Recognized, cURus 22.2 No. 4-04, IEC 60947-5-1 AC15	CCP-AUX*
Wired Remote Fuse Indication for PLC Applications	1 per CCP	24Vdc	100Vac	UL 98 Recognized, cURus 22.2 No. 4-04	CCP-PLC-IND*

* Refer to Data Sheet # 1157 for details.

Compact Circuit Protector (CCP) Disconnect Switch—30, 60 & 100A 1-, 2- & 3-Pole, Class CF CUBEFuse™



Switch											
Amp Rating	Fuse Class	Number of Poles	Volts	SCCR	Max Horsepower Rating				Wire Size	Wire Type*	Part Number
					120 Vac	240 Vac	480 Vac	600 Vac			
30	CF	1	600Vac 125Vdc	200kA	1.5	—	—	—	Single/Dual #18-6 Sol/Str	75°C Cu	CCP-1-30CF
30	CF	2	600Vac 125Vdc	200kA	—	3	—	—		75°C Cu	CCP-2-30CF
30	CF	3	600Vac 125Vdc	200kA	—	5	15	10	Single #4 Sol/Str	75°C Cu	CCP-3-30CF
60	CF	1	600Vac 125Vdc	200kA	3	—	—	—		Spade Terminal**	75°C Cu
60	CF	2	600Vac 125Vdc	200kA	—	7.5	—	—	75°C Cu		CCP-2-60CF
60	CF	3	600Vac 125Vdc	200kA	—	7.5	20	10	75°C Cu		CCP-3-60CF
100	CF	1	600Vac	200kA	5	—	—	—	Single #8-10 Sol/Str	75°C Cu	CCP-1-100CF
100	CF	2	600Vac	200kA	—	10	—	—		#8-1 Str Dual #6 Str	75°C Cu
100	CF	3	600Vac	200kA	—	20	50	50	Spade Terminal**		75°C Cu

* 75°C or higher.
** Spade terminal, 30A max, insulated flange, wire size #12-10 for #8 stud.

Specifications

Agency Information

- CE Compliant
- RoHS Compliant
- UL 98 Listed, File E302370, Guide WHTY
- cULus to CSA Standard 22.2 No. 4-04, File 302370, Guide WHTY7

Terminals

- Single/dual conductor box lug or spade terminal suitable for line, load or accessory connection
- Torque: 0-60A: - #18-10 20Lb-In
- #8-4 35Lb-In
70-100A: - #18-10 Single 25Lb-In
- #8-2 Single 35Lb-In
- #1 Single 40Lb-In
- #6 Dual 45Lb-In

Fuses

- Uses finger-safe Class CF CUBEFuse™ with Class J performance
 - Low-Peak™ dual-element, time-delay*
 - Non-indicating 1-100A
 - Indicating 6-100A
 - Fast-Acting** 1-100A

* See Data Sheet # 9000

** See Data sheet # 2147

Storage and Operating Temperature

- -20°C to 75°C***

*** For fuse performance under or above 25°C, consult fuse performance derating charts in the Bussmann publication titled *Selecting Protective Devices (SPD)* reorder #3002.

Flammability Rating UL 94V0

Lockout/Tagout Provisions

- 4mm shank lock or standard pin-out devices

Data Sheet: 1157

Mounting

- 35mm DIN-Rail

Local Open Fuse Indication Minimum Voltage†

- 90Vac/115Vdc

† Circuit must be closed for indication light to illuminate.

Features

- Ampacity rejecting disconnects will not accept CUBEFuse amp ratings greater than switch rating
- IP20 Finger-safe construction with #10 or larger wire
- Switch interlock prohibits removing the fuse under load

Accessories

- Auxiliary contacts
- PLC Wired remote fuse indication (up to 60A)

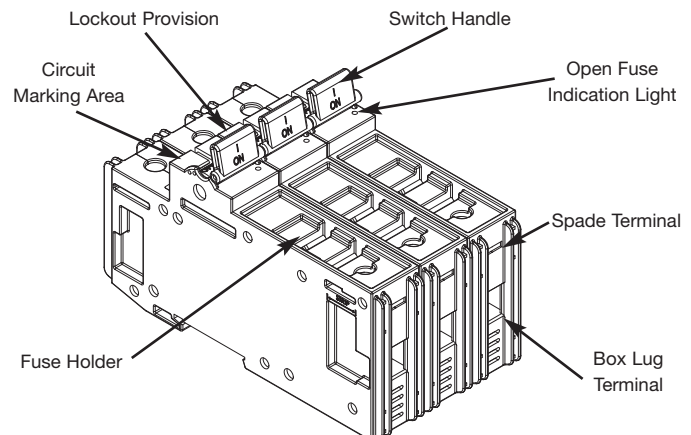

Compact Circuit Protector (CCP) Disconnect Switch—30, 60 & 100A 1-, 2- & 3-Pole, Class CF CUBEFuse™

Dimensions – mm (in)
30 and 60 Amp

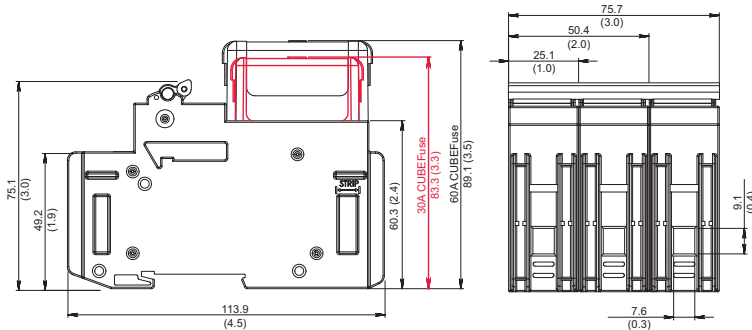

100 Amp

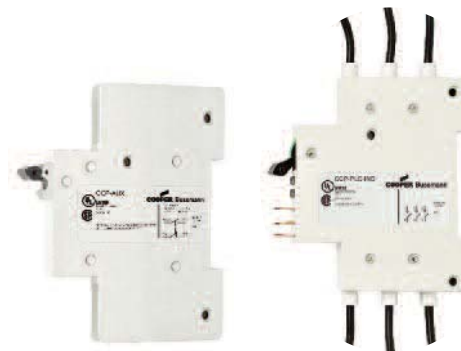
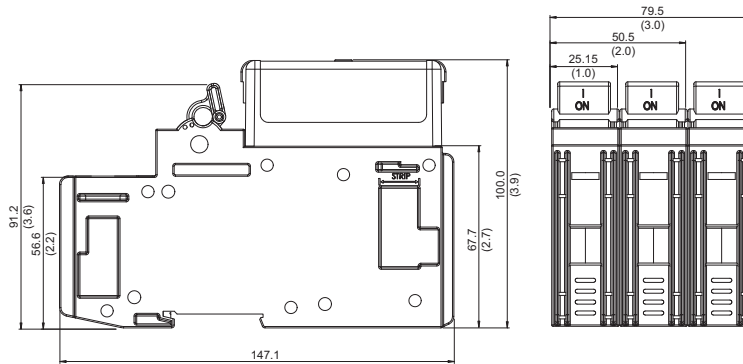

Auxiliary Contacts

PLC Indicator

(Includes leads with spade terminals)

CCP- _ _ CF Accessories					
Description	Configuration	Signal Output	Minimum Circuit Voltage	Agency Information	Part Number
Auxiliary Contacts NO+NC for Switch Status up to 60A	1 per CCP	5A/240Vac	–	UL 98 Recognized, cURus 22.2 No. 4-04, IEC 60947-5-1 AC15	CCP-AUX*
Auxiliary Contacts NO+NC for Switch Status 70 to 100A	1 per CCP	5A/240Vac	–	UL 98 Recognized, CSA C22.2 No. 4	CCP-AUX-100*
Wired Remote Fuse Indication for PLC Applications	1 per CCP	24Vdc	100Vac	UL 98 Recognized, cURus 22.2 No. 4-04	CCP-PLC-IND*
Wired Remote Fuse Indication for PLC Applications up to 60A	1 per CCP	8A/24Vdc	100Vac	UL 98 Recognized, CSA C22.2 No. 4	CCP-PLC-100*

* Refer to Data Sheet # 1157 for details.

Disconnect Switches

Compact Circuit Protector Base (CCPB) CUBEFuse™



The revolutionary Bussmann CCPB with CUBEFuse™ is designed as a fused branch circuit disconnect with fuse holder for the Bussmann Quik-Spec™ Coordination Panelboard. The CCPB with CUBEFuse simplifies selective coordination and allows for isolation of individual branch circuit loads for safe work practices.

Product Features and Benefits

- Uses finger-safe Class CF Low-Peak™ CUBEFuse with current-limiting, time-delay Class J performance*
- High Short-Circuit Current Ratings at 200kA
- Disconnect rated to provide means for load isolation
- Full voltage rated at 600Vac
- UL 98 Listed and suitable for branch circuit disconnect and branch circuit protection
- 1-, 2- and 3-pole versions are horsepower rated
- Patented rejection feature helps prevent overfusing
- Complies with UL and cULus
- Open fuse indication light per pole
- Additional open fuse indication can be provided by using the indicating CUBEFuse version
- Built-in switch/fuse interlock prohibits removing the fuse while energized
- Permanent lockout/tagout provisions
- Lock-ON provision

*See data sheet 9000 for CUBEFuse specifications.

**For fuse performance under or above 25°C, consult fuse performance derating charts.

Specifications:

- CCPB Ampacity rejection breaks: 15A, 20A, 30A, 40A, 50A, 60A, 70A, 90A and 100A.
- 1-, 2- and 3-Pole versions
- For systems 600Vac (or less)
- Box lug loadside terminal:
 - 18-6AWG single & dual rated, solid or stranded – 75°C, Cu only
 - 4AWG single – 75°C, Cu only
- Box lug loadside terminal torque: 18-10AWG 20 Lb-In (2.2 N•m), 8-4AWG 35 Lb-In (3.9 N•m)
- Spade terminal load connection: Max. 30A suitable for use with #8-32UNC screw
- Bolt-on style bus connector, #10-32-UNC Hex flange Phillips screw, torque to 25 Lb-In (2.8N•m)
- Lockout/tagout: 4mm shank lock
- Bolt-mounted design into Quik-Spec Coordination Panelboard bus
- Local indication: illumination requires closed circuit and minimum 90Vac operating voltage
- RoHS compliant

Agency Information:

UL 98 Listed, File E302370, Guide WHTY
cULus to CSA Standard 22.2 No. 4, File E302370, Guide WHTY7
CE Compliant

Shipping Weight: 2.03 lbs per carton

Carton quantity: 6 poles

Environmental Data

Storage and operating temperature: -20°C to 75°C**

Compact Circuit Protector Base (CCPB) CUBEFuse™

Technical Ratings

CCPB Part Numbers	Poles	Voltage Rating	CUBEFuse™ (Class J performance)			Max. Fuse** Ampacity	SCCR	Hp Ratings***
			Time-Delay Non-Indicating	Time-Delay Indicating*	Fast-Acting Non-Indicating			
CCPB-1-15CF	1	600Vac	TCF1RN, TCF3RN, TCF6RN, TCF10RN, TCF15RN	TCF6, TCF10, TCF15	FCF1RN, FCF3RN, FCF6RN, FCF10RN, FCF15RN	15A	200kA	0.5Hp@120V
CCPB-2-15CF	2							1.5Hp@240V
CCPB-3-15CF	3							3Hp@240V 5Hp@480V 7.5Hp@600V
CCPB-1-20CF	1	600Vac	TCF17-1/2RN, TCF20RN	TCF17-1/2, TCF20	FCF20RN	20A	200kA	0.75Hp@120V
CCPB-2-20CF	2							2Hp@240V
CCPB-3-20CF	3							3Hp@240V 7.5Hp@480V 10Hp@600V
CCPB-1-30CF	1	600Vac	TCF25RN, TCF30RN	TCF25, TCF30	FCF25RN, FCF30RN	30A	200kA	1.5Hp@120V
CCPB-2-30CF	2							3Hp@240V
CCPB-3-30CF	3							5Hp@240V 15Hp@480V 10Hp@600V
CCPB-1-40CF	1	600Vac	TCF35RN, TCF40RN	TCF35, TCF40	FCF35RN, FCF40RN	40A	200kA	2.0Hp@120V
CCPB-2-40CF	2							3Hp@240V
CCPB-3-40CF	3							7.5Hp@240V 20Hp@480V 10Hp@600V
CCPB-1-50CF	1	600Vac	TCF45RN, TCF50RN	TCF45, TCF50	FCF45RN, FCF50RN	50A	200kA	3.0Hp@120V
CCPB-2-50CF	2							5Hp@240V
CCPB-3-50CF	3							7.5Hp@240V 20Hp@480V 10Hp@600V
CCPB-1-60CF	1	600Vac	TCF60RN	TCF60	FCF60RN	60A	200kA	3.0Hp@120V
CCPB-2-60CF	2							7.5Hp@240V
CCPB-3-60CF	3							7.5Hp@240V 20Hp@480V 10Hp@600V
CCPB-1-70CF	1	600Vac	TCF70RN	TCF70	FCF70RN	70A	200kA	3.0Hp@120V
CCPB-2-70CF	2							7.5Hp@240V
CCPB-3-70CF	3							15Hp@240V 30Hp@480V
CCPB-1-90CF	1	600Vac	TCF90RN	TCF90	FCF80RN, FCF90RN	90A	200kA	5.0Hp@120V
CCPB-2-90CF	2							10Hp@240V
CCPB-3-90CF	3							20Hp@240V 40Hp@480V
CCPB-1-100CF	1	600Vac	TCF100RN	TCF100	FCF100RN	100A	200kA	5.0Hp@120V
CCPB-2-100CF	2							10Hp@240V
CCPB-3-100CF	3							20Hp@240V 50Hp@480V

*1A and 3A indicating CUBEFuse not available. Correct fit with CCPB disconnect requires indicating CUBEFuse with date code R38 or later.

**Any fuse with an amp rating less than or equal to the max fuse rating may be used. Example: TCF15 may be used with CCPB-1-20CF.

***Do not use UPS/Critical Application fast-acting CF with motors.

Disconnect Switches

UL 98 Fused Rotary Disconnect Switches—30 to 800A

Description

Bussmann UL 98 and UL 489 fused disconnect switches “break” and “make” power circuits ON and OFF load.

The switches employ double break contacts per pole that help ensure complete isolation of the fuse when the switch is in the “OFF” position.

Features

- Make and break power under load
- Double break by pole
- DIN-Rail or panel mount (30-100A)
- Up to 200kA Short-Circuit Current Rating
- Finger-safe covers
- Compact footprints available
- Defeatable handles automatically re-latch when the panel door is closed
- Most disconnect switches are front, right side, flange or direct handle operable
- NFPA 79 Compliant handle kits

Agency Information

- UL 98, Guide WHTY, File E155130
- UL 489, Guide WJAZ, File E359801
- CSA 22.2 No. 4, File 257020
- Conforms with IEC 60947-3
- NFPA 79 (2002 Edition)

Online Resources

Visit www.cooperbussmann.com/Disconnects for:

- CAD Drawings
- Instruction Sheets
- UL Information



QuikShip 
Everyday





QuikShip Everyday Service ships the most common part numbers within 24 hours. Contact your Bussmann representative for details.

Available Bussmann Fuses

Class	Type	Data Sheet #
CC	LP-CC Time-Delay, Current Limiting	1023
CC	FNQ-R Time-Delay	1014
CC	KTK-R Fast-Acting	1015
J	LPJ Time-Delay, Current Limiting	1006 (0-60A)
J		1007 (70-600A)
J	With easyID™ open fuse indication	1062 (6-60A)
J		1063 (70-600A)
J	JKS Fast-Acting Fuses	1026 (0-60A)
J		1027 (70-600A)
J	DFJ High Speed Drive Fuse	1048 (0-600A)
L	KRP-C Time-Delay, Current Limiting	1008
L	KTU Fast-Acting	1010
L	KLU Time-Delay	1013

UL 98 Fused Rotary Disconnect Switches—30 to 800A

Specifications

					
	RDF30CC-3	RDF30J-3 / RDF60J-3-COMP	RDF60J-3	RDF200J-3	RDF600J-3
Part Number					
2-Pole	—	—	RDF30J-2	RDF60J-2-COMP	RDF60J-2
3-Pole	RDF30CC-3	RDF30J-3-COMP	RDF30J-3	RDF60J-3-COMP	RDF60J-3
3-Pole + Neutral	RDF30CC-3N	RDF30J-3N-COMP	—	—	—
4-Pole	—	—	RDF30J-4	RDF60J-4-COMP	RDF60J-4
UL Standard	UL 489	UL 489	UL 98	UL 98	UL 98
Fuse Class	CC	J	J	J	J
Max Fuse/Ampacity	30	30	30	60	60
Switch Type	Compact	Compact	Standard	Standard	Standard
Handle Operation	Front	Front	Front/Side Flange	Front/Side Flange	Front/Side Flange
UL Electrical Ratings					
Max AC Volts	600Vac	600Vac	600Vac	600Vac	600Vac
Max DC Volts*	—	—	250Vdc	250Vdc	250Vdc
Std AC Horsepower Ratings					
1-Phase, 240Vac	—	—	3	10	10
3-Phase, 240Vac	3	3	3	7.5	15
3-Phase, 480Vac	5.0	5.0	5.0	15	25
3-Phase, 600Vac	7.5	7.5	7.5	15	30
Max AC Horsepower Ratings					
3-Phase, 240Vac	7.5	7.5	7.5	15	30
3-Phase, 480Vac	15	15	15	30	60
3-Phase, 600Vac	20	20	20	50	75
DC Horsepower Ratings					
125Vdc	—	—	3	5	7.5
250Vdc	—	—	5	10	20
Electrical Characteristics					
SCCR	100kA	100kA	200kA	100kA	200kA
Terminal Lugs/Kits	Integral	Integral	Integral	Integral	Integral
Mounting Torque - Lb-In (N·m)	—	—	—	—	160 (18)
Wire Type	75°C Cu	75°C Cu	75°C Cu	75°C Cu	75°C Cu/Al
Wire Range & Torque - Lb-In (N·m)					
Solid	#14-10 27 (3.1)	#14-10 27 (3.1)	#14-10 31 (3.5)	#14-10 31 (3.5)	#12-10 35.4 (4)
Stranded	#14-10 27 (3.1)	#14-10 27 (3.1)	#14-6 31 (3.5)	#14-6 31 (3.5)	#12-1 35.4 (4)
Mechanical Characteristics					
Endurances/Cycles	10,000	10,000	10,000	10,000	10,000
Physical Characteristics					
Dimensions					
See drawings on product pages					
Weight - Lbs (KG)					
2-Pole	—	—	3.0 (1.3)	3.1 (1.4)	4.0 (1.8)
3-Pole	1.3 (0.6)	1.4 (0.6)	3.8 (1.7)	4.1 (1.8)	5.3 (2.4)
3-Pole + Neutral	1.4 (0.6)	1.5 (0.7)	—	—	—
4-Pole	—	—	4.7 (2.1)	4.8 (2.2)	X.X (2.9)
Environmental					
Operating Temp. Range	-20°C to 70°C	-20°C to 70°C	-20°C to 70°C	-20°C to 70°C	-20°C to 70°C
Flammability Rating	UL 94-V0	UL 94-V0	UL 94-V0	UL 94-V0	UL 94-V0
Accessories					
Lug Kit	Integral	Integral	Integral	Integral	Integral
Handles					
Direct	•	•	•	•	•
Front Selector	•	•	—	—	—
Front Pistol	•	•	•	•	•
Side Pistol	—	—	•	•	•
Flange					
Cable	—	—	•	•	•
Shaft	—	—	•	•	•
NFPA Through Door Handle	•	•	•	•	•
Shafts c/s - mm	5x5	5x5	10x10	10x10	10x10
Terminal Shrouds	Not Required	Not Required	Not Required	Not Required	Not Required
Auxiliary Contacts					
(1) NO	•	•	•	•	•
(1) NC	•	•	•	•	•
AC Ratings					
Volts	600	600	600	600	600
Amps	10	10	10	10	10

Disconnect
Switches

• Available, see product page for details and part numbers.

— Not available.

* General purpose only, not photovoltaic rated.

UL 98 Fused Rotary Disconnect Switches—30A

Compact Class CC & Class J

For a Complete Assembly, Please Select:

SELECT FOR STANDARD APPLICATIONS	SWITCH		Switch																																																				
		<table border="1"> <thead> <tr> <th rowspan="2">Amp Rating</th> <th rowspan="2">Fuse Class</th> <th rowspan="2">Number of Poles</th> <th rowspan="2">SCCR</th> <th colspan="3">Max Horsepower Rating, 3-Ph</th> <th rowspan="2">Wire Size</th> <th rowspan="2">Wire Type</th> <th rowspan="2">Part Number</th> </tr> <tr> <th>220/240Vac</th> <th>440/480Vac</th> <th>600 Vac</th> </tr> </thead> <tbody> <tr> <td>30</td> <td>CC</td> <td>3</td> <td>100kA</td> <td>7.5</td> <td>15</td> <td>20</td> <td>#14-10 Sol/Str</td> <td>75°C Cu</td> <td>RDF30CC-3</td> </tr> <tr> <td>30</td> <td>CC</td> <td>3 + Ntrl*</td> <td>100kA</td> <td>7.5</td> <td>15</td> <td>20</td> <td>#14-10 Sol/Str</td> <td>75°C Cu</td> <td>RDF30CC-3N</td> </tr> <tr> <td>30</td> <td>J</td> <td>3</td> <td>100kA</td> <td>7.5</td> <td>15</td> <td>20</td> <td>#14-10 Sol/Str</td> <td>75°C Cu</td> <td>RDF30J-3-COMP</td> </tr> <tr> <td>30</td> <td>J</td> <td>3 + Ntrl*</td> <td>100kA</td> <td>7.5</td> <td>15</td> <td>20</td> <td>#14-10 Sol/Str</td> <td>75°C Cu</td> <td>RDF30J-3N-COMP</td> </tr> </tbody> </table>	Amp Rating	Fuse Class	Number of Poles	SCCR	Max Horsepower Rating, 3-Ph			Wire Size	Wire Type	Part Number	220/240Vac	440/480Vac	600 Vac	30	CC	3	100kA	7.5	15	20	#14-10 Sol/Str	75°C Cu	RDF30CC-3	30	CC	3 + Ntrl*	100kA	7.5	15	20	#14-10 Sol/Str	75°C Cu	RDF30CC-3N	30	J	3	100kA	7.5	15	20	#14-10 Sol/Str	75°C Cu	RDF30J-3-COMP	30	J	3 + Ntrl*	100kA	7.5	15	20	#14-10 Sol/Str	75°C Cu	RDF30J-3N-COMP
		Amp Rating					Fuse Class	Number of Poles	SCCR				Max Horsepower Rating, 3-Ph			Wire Size	Wire Type	Part Number																																					
			220/240Vac	440/480Vac	600 Vac																																																		
		30	CC	3	100kA	7.5	15	20	#14-10 Sol/Str	75°C Cu	RDF30CC-3																																												
		30	CC	3 + Ntrl*	100kA	7.5	15	20	#14-10 Sol/Str	75°C Cu	RDF30CC-3N																																												
		30	J	3	100kA	7.5	15	20	#14-10 Sol/Str	75°C Cu	RDF30J-3-COMP																																												
		30	J	3 + Ntrl*	100kA	7.5	15	20	#14-10 Sol/Str	75°C Cu	RDF30J-3N-COMP																																												
		* Neutral is switched.																																																					
		+																																																					
	Direct Mount Handle - mounts directly to switch, no shaft required																																																						
<table border="1"> <thead> <tr> <th>For Switch Part Number</th> <th>Color</th> <th>Test Function</th> <th>Padlockable</th> <th colspan="2"></th> <th>Part Number</th> </tr> </thead> <tbody> <tr> <td>RDF30CC-<u> </u></td> <td>Black</td> <td>Y</td> <td>Y</td> <td colspan="2"></td> <td>DIR-05</td> </tr> <tr> <td>RDF30J-<u> </u>-COMP</td> <td>Black</td> <td>Y</td> <td>Y</td> <td colspan="2"></td> <td>DIR-06</td> </tr> </tbody> </table>	For Switch Part Number	Color	Test Function	Padlockable			Part Number	RDF30CC- <u> </u>	Black	Y	Y			DIR-05	RDF30J- <u> </u> -COMP	Black	Y	Y			DIR-06																																		
For Switch Part Number	Color	Test Function	Padlockable			Part Number																																																	
RDF30CC- <u> </u>	Black	Y	Y			DIR-05																																																	
RDF30J- <u> </u> -COMP	Black	Y	Y			DIR-06																																																	
OR																																																							
	External Front Operated Selector Handle - shaft required																																																						
<table border="1"> <thead> <tr> <th>NEMA Type</th> <th>Color</th> <th>Test Function</th> <th>Padlockable</th> <th>Defeatable</th> <th>Part Number</th> </tr> </thead> <tbody> <tr> <td>1, 3R, 4, 4X, 12</td> <td>Black</td> <td>N</td> <td>Y</td> <td>Y</td> <td>H4X-04B</td> </tr> <tr> <td>1, 3R, 4, 4X, 12</td> <td>Red/Yellow</td> <td>N</td> <td>Y</td> <td>Y</td> <td>H4X-04R</td> </tr> </tbody> </table>	NEMA Type	Color	Test Function	Padlockable	Defeatable	Part Number	1, 3R, 4, 4X, 12	Black	N	Y	Y	H4X-04B	1, 3R, 4, 4X, 12	Red/Yellow	N	Y	Y	H4X-04R																																					
NEMA Type	Color	Test Function	Padlockable	Defeatable	Part Number																																																		
1, 3R, 4, 4X, 12	Black	N	Y	Y	H4X-04B																																																		
1, 3R, 4, 4X, 12	Red/Yellow	N	Y	Y	H4X-04R																																																		
	Shafts for Selector Handles																																																						
<table border="1"> <thead> <tr> <th>Length in (mm)</th> <th>Mounting Depth (X) in (mm)</th> <th colspan="2"></th> <th>Part Number</th> </tr> </thead> <tbody> <tr> <td>7.9 (200)</td> <td>4.02~9.65 (102~245)</td> <td colspan="2"></td> <td>SH1-200</td> </tr> <tr> <td>12.6 (320)</td> <td>4.02~14.37 (102~365)</td> <td colspan="2"></td> <td>SH1-320</td> </tr> <tr> <td>15.7 (400)</td> <td>4.02~17.52 (102~445)</td> <td colspan="2"></td> <td>SH1-400</td> </tr> </tbody> </table>	Length in (mm)	Mounting Depth (X) in (mm)			Part Number	7.9 (200)	4.02~9.65 (102~245)			SH1-200	12.6 (320)	4.02~14.37 (102~365)			SH1-320	15.7 (400)	4.02~17.52 (102~445)			SH1-400																																			
Length in (mm)	Mounting Depth (X) in (mm)			Part Number																																																			
7.9 (200)	4.02~9.65 (102~245)			SH1-200																																																			
12.6 (320)	4.02~14.37 (102~365)			SH1-320																																																			
15.7 (400)	4.02~17.52 (102~445)			SH1-400																																																			
OR																																																							
	External Front Operated Pistol Handles - shaft required																																																						
<table border="1"> <thead> <tr> <th>NEMA Type</th> <th>Color</th> <th>Test Function</th> <th>Padlockable</th> <th>Defeatable</th> <th>Part Number</th> </tr> </thead> <tbody> <tr> <td>1, 3R, 12</td> <td>Black</td> <td>N</td> <td>Y</td> <td>Y</td> <td>H12-05B</td> </tr> <tr> <td>1, 3R, 12</td> <td>Red/Yellow</td> <td>N</td> <td>Y</td> <td>Y</td> <td>H12-05R</td> </tr> <tr> <td>1, 3R, 4, 4X, 12</td> <td>Black</td> <td>N</td> <td>Y</td> <td>Y</td> <td>H4X-05B</td> </tr> <tr> <td>1, 3R, 4, 4X, 12</td> <td>Red/Yellow</td> <td>N</td> <td>Y</td> <td>Y</td> <td>H4X-05R</td> </tr> <tr> <td>1, 3R, 4, 4X, 12</td> <td>Black</td> <td>Y</td> <td>Y</td> <td>Y</td> <td>H4X-05TB</td> </tr> <tr> <td>1, 3R, 4, 4X, 12</td> <td>Red/Yellow</td> <td>Y</td> <td>Y</td> <td>Y</td> <td>H4X-05TR</td> </tr> </tbody> </table>	NEMA Type	Color	Test Function	Padlockable	Defeatable	Part Number	1, 3R, 12	Black	N	Y	Y	H12-05B	1, 3R, 12	Red/Yellow	N	Y	Y	H12-05R	1, 3R, 4, 4X, 12	Black	N	Y	Y	H4X-05B	1, 3R, 4, 4X, 12	Red/Yellow	N	Y	Y	H4X-05R	1, 3R, 4, 4X, 12	Black	Y	Y	Y	H4X-05TB	1, 3R, 4, 4X, 12	Red/Yellow	Y	Y	Y	H4X-05TR													
NEMA Type	Color	Test Function	Padlockable	Defeatable	Part Number																																																		
1, 3R, 12	Black	N	Y	Y	H12-05B																																																		
1, 3R, 12	Red/Yellow	N	Y	Y	H12-05R																																																		
1, 3R, 4, 4X, 12	Black	N	Y	Y	H4X-05B																																																		
1, 3R, 4, 4X, 12	Red/Yellow	N	Y	Y	H4X-05R																																																		
1, 3R, 4, 4X, 12	Black	Y	Y	Y	H4X-05TB																																																		
1, 3R, 4, 4X, 12	Red/Yellow	Y	Y	Y	H4X-05TR																																																		
	Metallic Hasp (Heavy Duty) External Front Operated Pistol Handles - shaft required																																																						
<table border="1"> <thead> <tr> <th>NEMA Type</th> <th>Color</th> <th>Test Function</th> <th>Padlockable</th> <th>Defeatable</th> <th>Part Number</th> </tr> </thead> <tbody> <tr> <td>1, 3R, 4, 4X, 12</td> <td>Black</td> <td>N</td> <td>Y</td> <td>Y</td> <td>H4X-05BHD</td> </tr> <tr> <td>1, 3R, 4, 4X, 12</td> <td>Red/Yellow</td> <td>N</td> <td>Y</td> <td>Y</td> <td>H4X-05RHD</td> </tr> </tbody> </table>	NEMA Type	Color	Test Function	Padlockable	Defeatable	Part Number	1, 3R, 4, 4X, 12	Black	N	Y	Y	H4X-05BHD	1, 3R, 4, 4X, 12	Red/Yellow	N	Y	Y	H4X-05RHD																																					
NEMA Type	Color	Test Function	Padlockable	Defeatable	Part Number																																																		
1, 3R, 4, 4X, 12	Black	N	Y	Y	H4X-05BHD																																																		
1, 3R, 4, 4X, 12	Red/Yellow	N	Y	Y	H4X-05RHD																																																		
	Shafts for Pistol Handles																																																						
<table border="1"> <thead> <tr> <th>Length in (mm)</th> <th>Mounting Depth (X) in (mm)</th> <th colspan="2"></th> <th>Part Number</th> </tr> </thead> <tbody> <tr> <td>7.9 (200)</td> <td>4.02~9.65 (102~245)</td> <td colspan="2"></td> <td>SH2-200</td> </tr> <tr> <td>12.6 (320)</td> <td>4.02~14.37 (102~365)</td> <td colspan="2"></td> <td>SH2-320</td> </tr> <tr> <td>15.7 (400)</td> <td>4.02~17.52 (102~445)</td> <td colspan="2"></td> <td>SH2-400</td> </tr> </tbody> </table>	Length in (mm)	Mounting Depth (X) in (mm)			Part Number	7.9 (200)	4.02~9.65 (102~245)			SH2-200	12.6 (320)	4.02~14.37 (102~365)			SH2-320	15.7 (400)	4.02~17.52 (102~445)			SH2-400																																			
Length in (mm)	Mounting Depth (X) in (mm)			Part Number																																																			
7.9 (200)	4.02~9.65 (102~245)			SH2-200																																																			
12.6 (320)	4.02~14.37 (102~365)			SH2-320																																																			
15.7 (400)	4.02~17.52 (102~445)			SH2-400																																																			
OR																																																							
	NFPA Through the Door Handle Kit - to be used with selector handle or front pistol handle																																																						
<table border="1"> <thead> <tr> <th>Color</th> <th>Test Function</th> <th>Padlockable</th> <th>Defeatable</th> <th>Part Number</th> </tr> </thead> <tbody> <tr> <td>Red</td> <td>N</td> <td>Y</td> <td>N</td> <td>H79-1</td> </tr> </tbody> </table>	Color	Test Function	Padlockable	Defeatable	Part Number	Red	N	Y	N	H79-1																																													
Color	Test Function	Padlockable	Defeatable	Part Number																																																			
Red	N	Y	N	H79-1																																																			
and...																																																							
ACCESSORIES	AUXILIARY CONTACTS		Auxiliary Contacts																																																				
		<table border="1"> <thead> <tr> <th>Contact Type</th> <th>Number of Contacts</th> <th>Continuous Amp Rating</th> <th>Voltage Rating</th> <th colspan="2">Maximum Number of Auxiliary Contacts per Disconnect Switch Part Number</th> <th>Part Number</th> </tr> </thead> <tbody> <tr> <td>NO</td> <td>1</td> <td>10A</td> <td>600Vac</td> <td colspan="2">RDF30CC-<u> </u>: 4 / 8 with BAC-HOLDER2</td> <td>BAC05⁽¹⁾</td> </tr> <tr> <td>NC</td> <td>1</td> <td>10A</td> <td>600Vac</td> <td colspan="2">RDF30J-<u> </u>-COMP: 2 / 6 with BAC-HOLDER2</td> <td>BAC06⁽¹⁾</td> </tr> <tr> <td>Auxiliary Contact Holder</td> <td colspan="3"></td> <td colspan="2">Accepts 4 Auxiliary Contacts: BAC05 or BAC06</td> <td>BAC-HOLDER2⁽²⁾</td> </tr> </tbody> </table>	Contact Type	Number of Contacts	Continuous Amp Rating	Voltage Rating	Maximum Number of Auxiliary Contacts per Disconnect Switch Part Number		Part Number	NO	1	10A	600Vac	RDF30CC- <u> </u> : 4 / 8 with BAC-HOLDER2		BAC05 ⁽¹⁾	NC	1	10A	600Vac	RDF30J- <u> </u> -COMP: 2 / 6 with BAC-HOLDER2		BAC06 ⁽¹⁾	Auxiliary Contact Holder				Accepts 4 Auxiliary Contacts: BAC05 or BAC06		BAC-HOLDER2 ⁽²⁾																									
		Contact Type	Number of Contacts	Continuous Amp Rating	Voltage Rating	Maximum Number of Auxiliary Contacts per Disconnect Switch Part Number		Part Number																																															
		NO	1	10A	600Vac	RDF30CC- <u> </u> : 4 / 8 with BAC-HOLDER2		BAC05 ⁽¹⁾																																															
NC	1	10A	600Vac	RDF30J- <u> </u> -COMP: 2 / 6 with BAC-HOLDER2		BAC06 ⁽¹⁾																																																	
Auxiliary Contact Holder				Accepts 4 Auxiliary Contacts: BAC05 or BAC06		BAC-HOLDER2 ⁽²⁾																																																	

UL 98 Fused Rotary Disconnect Switches—30A

Compact Class CC & Class J

Dimensions – in (mm)

- RDF30CC-₋

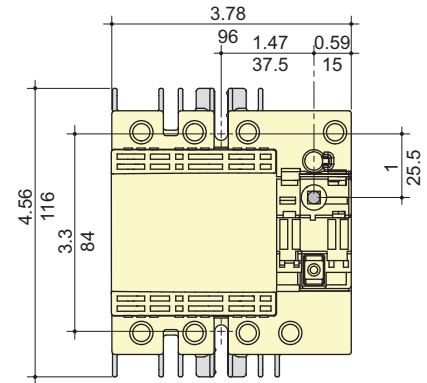
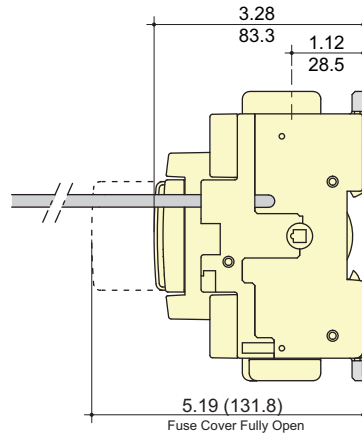

- RDF30J-₋COMP

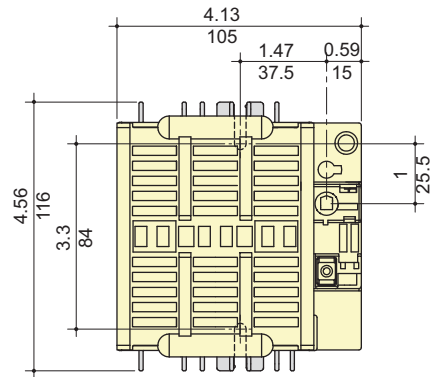
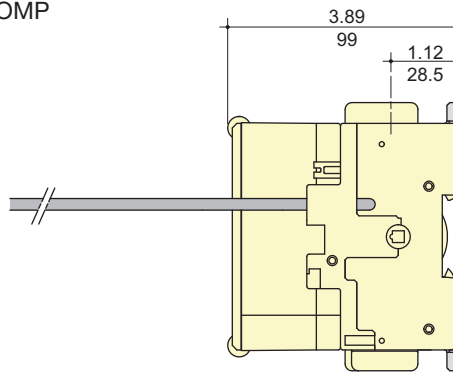

Disconnect
Switches

External Front Selector Handle

Selector Handle Type

Direction of Front Operation

Door Drilling Layout

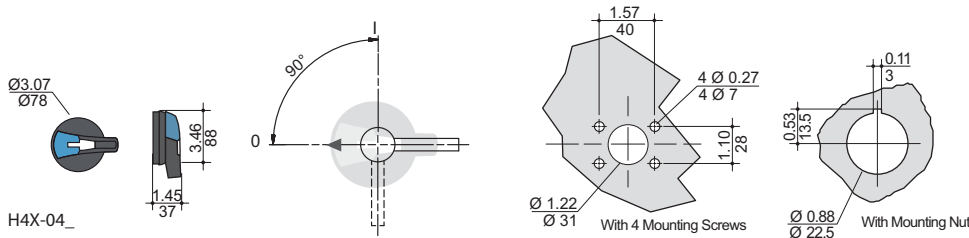

External Front Pistol Handles

Pistol Handle Type

Direction of Front Operation

Door Drilling Layout

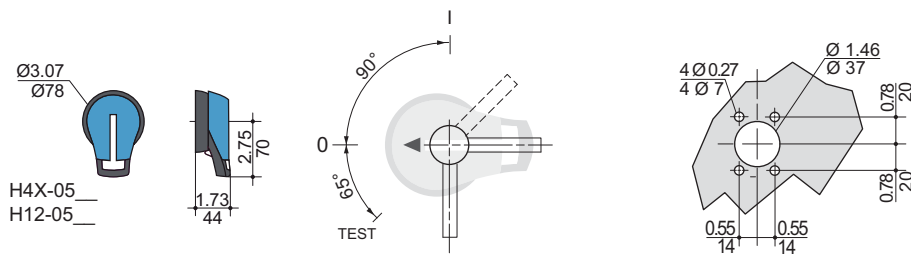

UL 98 Fused Rotary Disconnect Switches—30A

Standard Class J

For a Complete Assembly, Please Select:

SWITCH		Switch												
		Amp Rating	Fuse Class	No. of Poles	SCCR	Max Horsepower Rating					Wire Size	Wire Type	Part Number	
					1-Phase 220/240Vac	3-Phase		600 Vac	DC*					
						220/240Vac	440/480Vac		125 Vdc	250 Vdc				
		30	J	2	200kA	3	-	-	-	3	5	#14-10 Sol #14-6 Str	75°C Cu	RDF30J-2
		30	J	3	200kA	-	7.5	15	20	3	5	#14-10 Sol #14-6 Str	75°C Cu	RDF30J-3
		30	J	4	200kA	-	7.5	15	20	3	5	#14-10 Sol #14-6 Str	75°C Cu	RDF30J-4
		* DC Ratings use two poles in series.												
		+												
	HANDLE		Direct Mount Handle - mounts directly to switch, no shaft required											
		For Switch Part Number	Color	Test Function	Padlockable							Part Number		
		All Switches	Black	Y	Y - On Switch							DIR-07		
		or												
		External Front Operated Pistol Handles - shaft required												
		NEMA Type	Color	Test Function	Padlockable	Defeatable						Part Number		
		1, 3R, 12	Black	N	Y	Y						H12-05B		
		1, 3R, 12	Red/Yellow	N	Y	Y						H12-05R		
		1, 3R, 4, 4X, 12	Black	N	Y	Y						H4X-05B		
		1, 3R, 4, 4X, 12	Red/Yellow	N	Y	Y						H4X-05R		
or		Metallic Hasp (Heavy Duty) External Front Operated Pistol Handles - shaft required												
	NEMA Type	Color	Test Function	Padlockable	Defeatable						Part Number			
	1, 3R, 4, 4X, 12	Black	N	Y	Y						H4X-05BHD			
	1, 3R, 4, 4X, 12	Red/Yellow	N	Y	Y						H4X-05RHD			
	External Right Side Operated Pistol Handles - shaft required													
	NEMA Type	Color	Test Function	Padlockable	Defeatable						Part Number			
	1, 3R, 4, 4X, 12	Black	N	Y	N/A						H4X-05SB			
	1, 3R, 4, 4X, 12	Red/Yellow	N	Y	N/A						H4X-05SR			
	Shafts for Pistol Handles													
	Length in (mm)	Mounting Depth (X) in (mm)								Part Number				
	7.9 (200)	5.30~9.06 (135~230)								SH5-200				
	12.6 (320)	5.30~13.78 (135~350)								SH5-320				
	15.7 (400)	5.30~16.93 (135~430)								SH5-400				
	or													
	Flange Handle⁽¹⁾ - requires shaft operated mechanism or cable operated mechanism + cable													
	NEMA Type	Flange Style	Test Function	Padlockable	Defeatable						Part Number			
	1, 3R, 4, 12	Standard	N	Y	Y						FLH1			
	1, 3R, 4, 4X, 12	Chrome Plated	N	Y	Y						FLH2			
	Shaft Operated Flange Mechanism⁽²⁾ - includes shaft													
	For Enclosure Depth - in (mm)										Part Number			
	6~24 (152~613)										FLRM			
	Cable Operated Flange Mechanism and Cable - must select Mechanism⁽³⁾ and Cable⁽⁴⁾													
	Item / Length										Part Number			
	Cable Mechanism										FLCM			
	36" (900mm) Cable										FLC36			
	60" (1500mm) Cable										FLC60			
	120" (3000mm) Cable										FLC120			
	or													
	NFPA Through the Door Handle Kit - to be used with selector handle or front pistol handle													
	Color	Test Function	Padlockable	Defeatable							Part Number			
	Red	N	Y	N							H79-2			

UL 98 Fused Rotary Disconnect Switches—30A Standard Class J

ACC. AUX CONTACTS		and ...				
		Auxiliary Contacts				
Contact Type	Number of Contacts	Continuous Amp Rating	Voltage Rating	Max Number of Aux Contacts per Switch	Part Number	
NO	1	10A	600Vac	4	BAC05	
NC	1	10A	600Vac	4	BAC06	

Dimensions – in (mm)

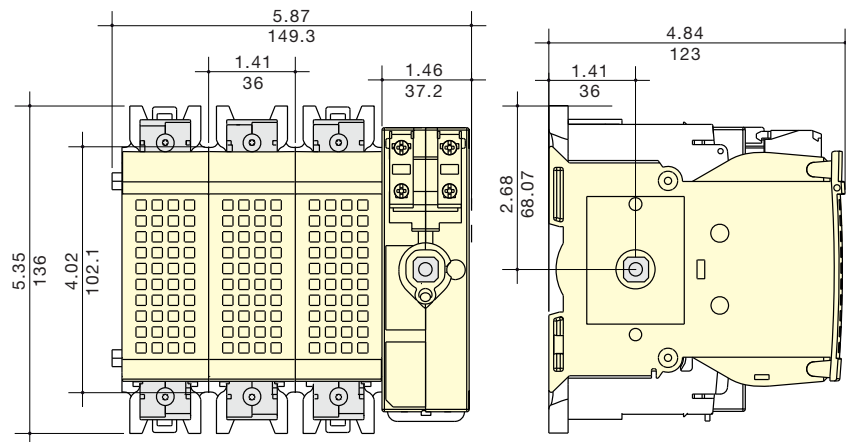

Direct Mount Handle

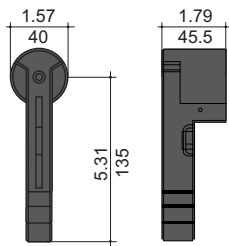

DIR-07

Flange Handle

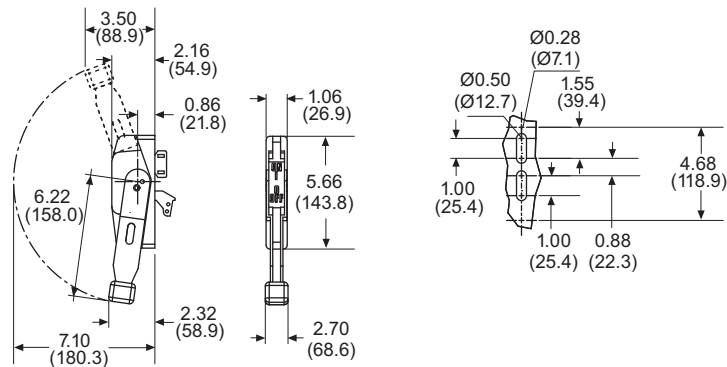

FLH_

External Front & Right Side Pistol Handle

Handle Type

Direction of Front Operation

Direction of Right Side Operation

Door Drilling Layout

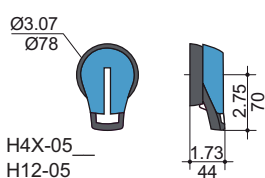

H4X-05
H12-05

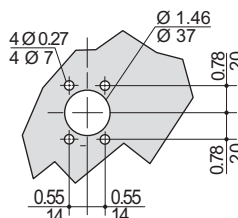
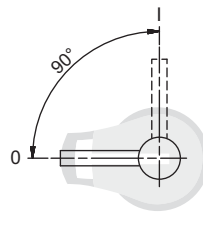
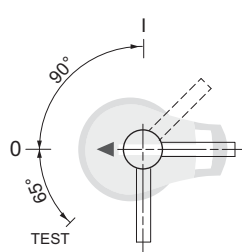

UL 98 Fused Rotary Disconnect Switches—60A

Compact Class J

For a Complete Assembly, Please Select:

SWITCH		Switch												
		Amp Rating	Fuse Class	Number of Poles	SCCR	Max Horsepower Rating						Wire Size	Wire Type	Part Number
						1-Phase 220/240Vac	3-Phase 220/240Vac	440/480Vac	600 Vac	DC*				
		60	J	2	100kA	10	-	-	-	5	10	#14-10 Sol #14-6 Str	75°C Cu	RDF60J-2-COMP
	60	J	3	100kA	-	15	30	50	5	10	#14-10 Sol #14-6 Str	75°C Cu	RDF60J-3-COMP	
	60	J	4	100kA	-	15	30	50	5	10	#14-10 Sol #14-6 Str	75°C Cu	RDF60J-4-COMP	
	* DC Ratings use two poles in series.													
	+													
	HANDLE		Direct Mount Handle - mounts directly to switch, no shaft required											
			For Switch Part Number	Color	Test Function	Padlockable	Part Number							
All Switches		Black	Y	Y - On Switch	DIR-07									
or														
 or  + 		External Front Operated Pistol Handles - shaft required												
		NEMA Type	Color	Test Function	Padlockable	Defeatable	Part Number							
		1, 3R, 12	Black	N	Y	Y	H12-05B							
		1, 3R, 12	Red/Yellow	N	Y	Y	H12-05R							
		1, 3R, 4, 4X, 12	Black	N	Y	Y	H4X-05B							
		1, 3R, 4, 4X, 12	Red/Yellow	N	Y	Y	H4X-05R							
	1, 3R, 4, 4X, 12	Black	Y	Y	Y	H4X-05TB								
	1, 3R, 4, 4X, 12	Red/Yellow	Y	Y	Y	H4X-05TR								
	Metallic Hasp (Heavy Duty) External Front Operated Pistol Handles - shaft required													
	NEMA Type	Color	Test Function	Padlockable	Defeatable	Part Number								
1, 3R, 4, 4X, 12	Black	N	Y	Y	H4X-05BHD									
1, 3R, 4, 4X, 12	Red/Yellow	N	Y	Y	H4X-05RHD									
External Right Side Operated Pistol Handles - shaft required														
NEMA Type	Color	Test Function	Padlockable	Defeatable	Part Number									
1, 3R, 4, 4X, 12	Black	N	Y	N/A	H4X-05SB									
1, 3R, 4, 4X, 12	Red/Yellow	N	Y	N/A	H4X-05SR									
Shafts for Pistol Handles														
Length in (mm)	Mounting Depth (X) in (mm)				Part Number									
7.9 (200)	5.30~9.06 (135~230)					SH5-200								
12.6 (320)	5.30~13.78 (135~350)					SH5-320								
15.7 (400)	5.30~16.93 (135~430)					SH5-400								
or														
	Flange Handle⁽¹⁾ - requires shaft operated mechanism or cable operated mechanism + cable													
	NEMA Type	Flange Style	Test Function	Padlockable	Defeatable	Part Number								
	1, 3R, 4, 12	Standard	N	Y	Y	FLH1								
	1, 3R, 4, 4X, 12	Chrome Plated	N	Y	Y	FLH2								
	Shaft Operated Flange Mechanism⁽²⁾ - includes shaft													
	For Enclosure Depth - in (mm)					Part Number								
	6-24 (152~613)					FLRM								
	Cable Operated Flange Mechanism and Cable - must select Mechanism⁽³⁾ and Cable⁽⁴⁾													
	Item / Length					Part Number								
	Cable Mechanism					FLCM								
36" (900mm) Cable					FLC36									
60" (1500mm) Cable					FLC60									
120" (3000mm) Cable					FLC120									
or														
	NFPA Through the Door Handle Kit - to be used with selector handle or front pistol handle													
	Color	Test Function	Padlockable	Defeatable	Part Number									
Red	N	Y	N	H79-2										

UL 98 Fused Rotary Disconnect Switches—60A

Compact Class J

and ...

Acc. AUX CONTACTS		Auxillary Contacts				Max Number of Aux Contacts per Switch	Part Number
		Contact Type	Number of Contacts	Continuous Amp Rating	Voltage Rating		
		NO	1	10A	600Vac	4	BAC05
		NC	1	10A	600Vac	4	BAC06

Dimensions – in (mm)

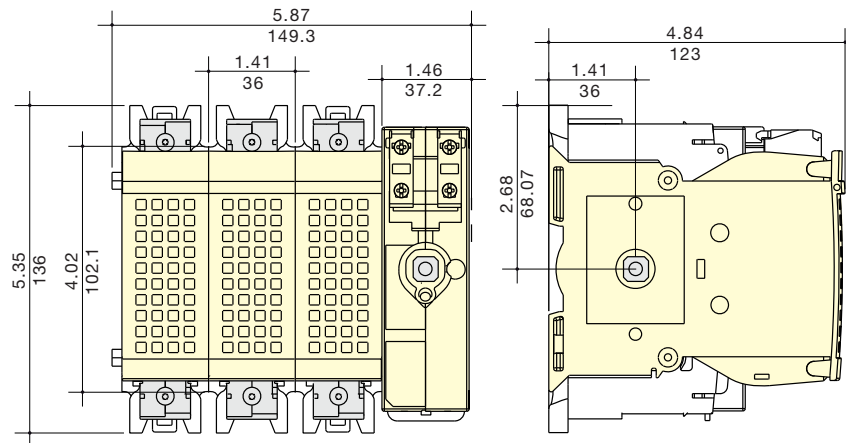

Direct Mount Handle

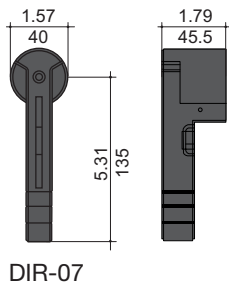

Flange Handle

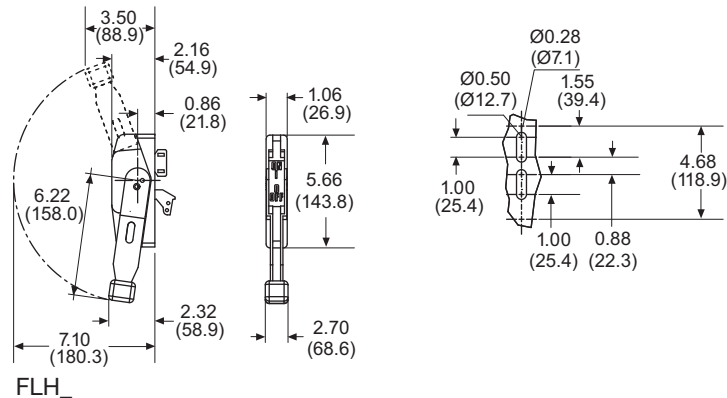

External Front & Right Side Pistol Handle

Handle Type

Direction of Front Operation

Direction of Right Side Operation



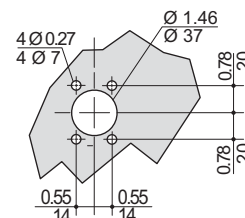
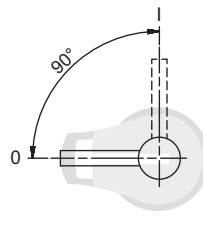
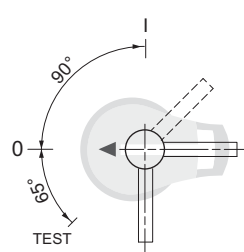
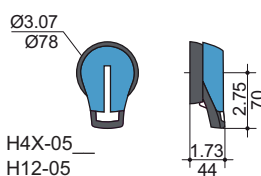

Door Drilling Layout



UL 98 Fused Rotary Disconnect Switches—60A

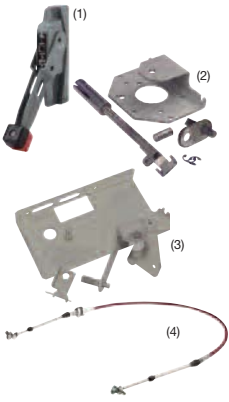

Standard Class J

For a Complete Assembly, Please Select:

SWITCH		Switch												
		Amp Rating	Fuse Class	Number of Poles	SCCR	Max Horsepower Rating						Wire Size	Wire Type	Part Number
						1-Phase 220/240Vac	3-Phase 220/240Vac	440/480Vac	600 Vac	DC*				
		60	J	2	200kA	10	-	-	-	5	10	#12-10 Sol #12-1 Str	75°C Cu	RDF60J-2
60	J	3	200kA	-	15	30	50	5	10	#12-10 Sol #12-1 Str	75°C Cu	RDF60J-3		
60	J	4	200kA	-	15	30	50	5	10	#12-10 Sol #12-1 Str	75°C Cu	RDF60J-4		
* DC Ratings use two poles in series.														
+														
HANDLE		Direct Mount Handle - mounts directly to switch, no shaft required												
		For Switch Part Number	Color	Test Function	Padlockable							Part Number		
		All Switches	Black	Y	Y							DIR-07		
OR														
Select for Standard Applications	 or 	External Front Operated Pistol Handles - shaft required												
		NEMA Type	Color	Test Function	Padlockable	Defeatable							Part Number	
		1, 3R, 12	Black	N	Y	Y							H12-03B	
		1, 3R, 12	Red/Yellow	N	Y	Y							H12-03R	
		1, 3R, 4, 4X, 12	Black	N	Y	Y							H4X-06B	
		1, 3R, 4, 4X, 12	Red/Yellow	N	Y	Y							H4X-06R	
		1, 3R, 4, 4X, 12	Black	Y	Y	Y							H4X-06TB	
		1, 3R, 4, 4X, 12	Red/Yellow	Y	Y	Y							H4X-06TR	
		Metallic Hasp (Heavy Duty) External Front Operated Pistol Handles - shaft required												
		NEMA Type	Color	Test Function	Padlockable	Defeatable							Part Number	
		1, 3R, 4, 4X, 12	Black	N	Y	Y							H4X-06BHD	
		1, 3R, 4, 4X, 12	Red/Yellow	N	Y	Y							H4X-06RHD	
		External Right Side Operated Pistol Handles - shaft required												
		NEMA Type	Color	Test Function	Padlockable	Defeatable							Part Number	
		1, 3R, 4, 4X, 12	Black	N	Y	N/A							H4X-06SB	
1, 3R, 4, 4X, 12	Red/Yellow	N	Y	N/A							H4X-06SR			
Shafts for Pistol Handles														
Length in (mm)	Mounting Depth (X) in (mm)										Part Number			
7.9 (200)	5.30~9.06 (135~230)										SH5-200			
12.6 (320)	5.30~13.78 (135~350)										SH5-320			
15.7 (400)	5.30~16.93 (135~430)										SH5-400			
OR														
	Flange Handle⁽¹⁾ - requires shaft operated mechanism or cable operated mechanism + cable													
	NEMA Type	Flange Style	Test Function	Padlockable	Defeatable							Part Number		
	1, 3R, 4, 12	Standard	N	Y	Y							FLH1		
	1, 3R, 4, 4X, 12	Chrome Plated	N	Y	Y							FLH2		
	Shaft Operated Flange Mechanism⁽²⁾ - includes shaft													
	For Enclosure Depth in (mm)											Part Number		
	6~24 (152~613)											FLRM		
	Cable Operated Flange Mechanism and Cable - must select Mechanism⁽³⁾ and Cable⁽⁴⁾													
	Item / Length											Part Number		
	Cable Mechanism											FLCM		
36" (900mm) Cable											FLC36			
60" (1500mm) Cable											FLC60			
120" (3000mm) Cable											FLC120			

UL 98 Fused Rotary Disconnect Switches—60A

Standard Class J

Select		or					
NFPA HANDLE		NFPA Through the Door Handle Kit - to be used with front pistol handle					
		Color		Test Function	Padlockable	Defeatable	Part Number
		Red		N	Y	N	H79-2
Acc.		and ...					
AUX CONTACTS		Auxiliary Contacts					
		Contact Type	Number of Contacts	Continuous Amp Rating	Voltage Rating	Max Number of Aux Contacts per Switch	Part Number
		NO	1	10A	600Vac	4	BAC05
		NC	1	10A	600Vac	4	BAC06

Dimensions – in (mm)

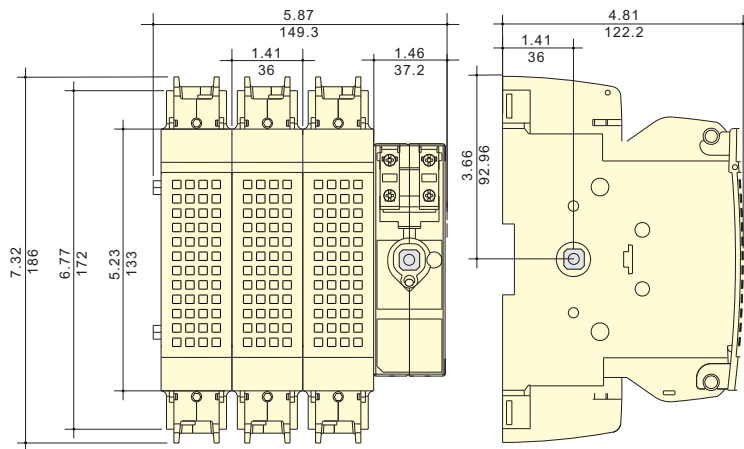

Direct Mount Handle

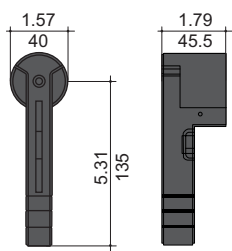

DIR-07

Flange Handle

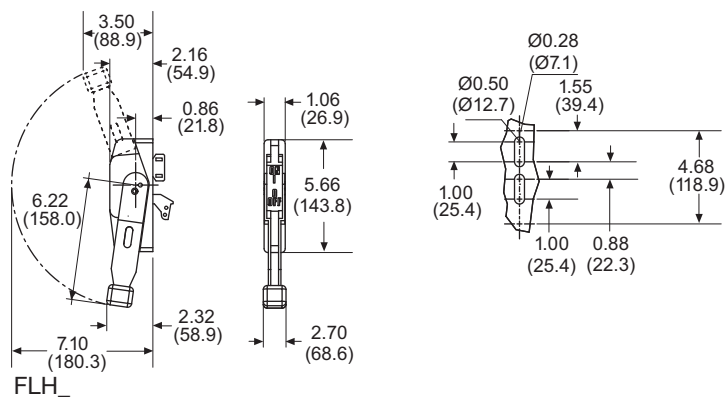

FLH_

External Front and Right Side Pistol Handle

Handle Type Direction of Front Operation Direction of Right Side Operation Door Drilling Layout

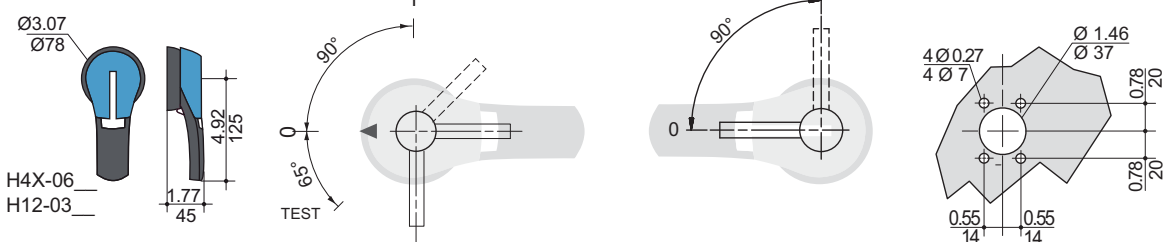



H4X-06
H12-03

Disconnect
Switches

UL 98 Fused Rotary Disconnect Switches—100A

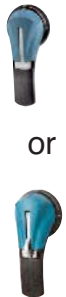
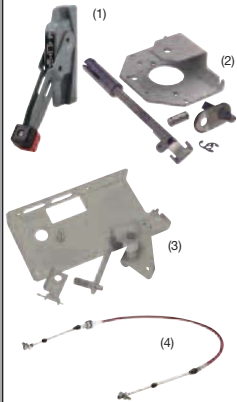

Standard Class J

For a Complete Assembly, Please Select:

SWITCH		Switch												
		Amp Rating	Fuse Class	Number of Poles	SCCR	Max Horsepower Rating						Wire Size	Wire Type	Part Number
						1-Phase 220/240Vac	220/240Vac	440/480Vac	600 Vac	DC*				
		100	J	2	200kA	10	-	-	-	7.5	20	#12-10 Sol #12-1 Str	75°C Cu	RDF100J-2
100	J	3	200kA	-	30	60	75	7.5	20	#12-10 Sol #12-1 Str	75°C Cu	RDF100J-3		
100	J	4	200kA	-	30	60	75	7.5	20	#12-10 Sol #12-1 Str	75°C Cu	RDF100J-4		
* DC Ratings use two poles in series.														
+														
HANDLE		Direct Mount Handle - mounts directly to switch, no shaft required												
		For Switch Part Number	Color	Test Function	Padlockable							Part Number		
		All Switches	Black	Y	Y							DIR-07		
or														
Select for Standard Applications		External Front Operated Pistol Handles - shaft required												
		NEMA Type	Color	Test Function	Padlockable	Defeatable							Part Number	
		1, 3R, 12	Black	N	Y	Y							H12-03B	
		1, 3R, 12	Red/Yellow	N	Y	Y							H12-03R	
		1, 3R, 4, 4X, 12	Black	N	Y	Y							H4X-06B	
		1, 3R, 4, 4X, 12	Red/Yellow	N	Y	Y							H4X-06R	
		1, 3R, 4, 4X, 12	Black	Y	Y	Y							H4X-06TB	
		1, 3R, 4, 4X, 12	Red/Yellow	Y	Y	Y							H4X-06TR	
		Metallic Hasp (Heavy Duty) External Front Operated Pistol Handles - shaft required												
		NEMA Type	Color	Test Function	Padlockable	Defeatable							Part Number	
		1, 3R, 4, 4X, 12	Black	N	Y	Y							H4X-06BHD	
		1, 3R, 4, 4X, 12	Red/Yellow	N	Y	Y							H4X-06RHD	
		External Right Side Operated Pistol Handles - shaft required												
		NEMA Type	Color	Test Function	Padlockable	Defeatable							Part Number	
		1, 3R, 4, 4X, 12	Black	N	Y	N/A							H4X-06SB	
1, 3R, 4, 4X, 12	Red/Yellow	N	Y	N/A							H4X-06SR			
Shafts for Pistol Handles														
Length in (mm)	Mounting Depth (X) in (mm)										Part Number			
7.9 (200)	5.30~9.06 (135~230)										SH5-200			
12.6 (320)	5.30~13.78 (135~350)										SH5-320			
15.7 (400)	5.30~16.93 (135~430)										SH5-400			
or														
	Flange Handle⁽¹⁾ - requires shaft operated mechanism or cable operated mechanism + cable													
	NEMA Type	Flange Style	Test Function	Padlockable	Defeatable							Part Number		
	1, 3R, 4, 12	Standard	N	Y	Y							FLH1		
	1, 3R, 4, 4X, 12	Chrome Plated	N	Y	Y							FLH2		
	Shaft Operated Flange Mechanism⁽²⁾ - includes shaft													
	For Enclosure Depth in (mm)											Part Number		
	6~24 (152~613)											FLRM		
	Cable Operated Flange Mechanism and Cable - must select Mechanism⁽³⁾ and Cable⁽⁴⁾													
	Item / Length											Part Number		
	Cable Mechanism											FLCM		
36" (900mm) Cable											FLC36			
60" (1500mm) Cable											FLC60			
120" (3000mm) Cable											FLC120			

UL 98 Fused Rotary Disconnect Switches—100A

Standard Class J

Select		or				
		NFPA Through the Door Handle Kit - to be used with front pistol handle				
NFPA HANDLE		Color	Test Function	Padlockable	Defeatable	Part Number
		Red	N	Y	N	H79-2
Acc.		and ...				
AUX. CONTACTS		Auxiliary Contacts				Part Number
		Contact Type	Number of Contacts	Continuous Amp Rating	Voltage Rating	
		NO	1	10A	600Vac	4
NC	1	10A	600Vac	4	BAC06	

Dimensions – in (mm)

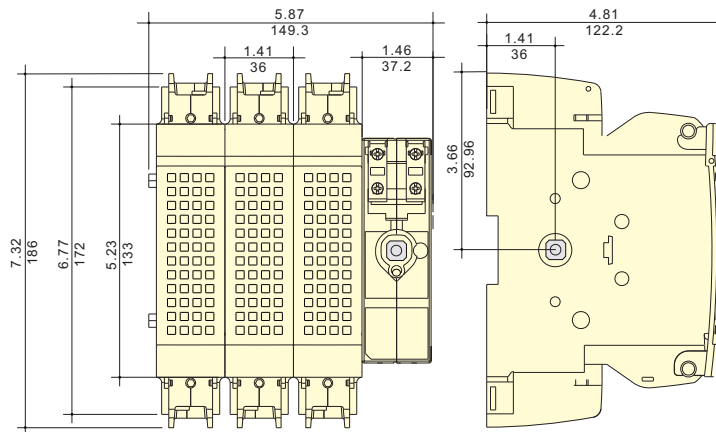

Direct Mount Handle

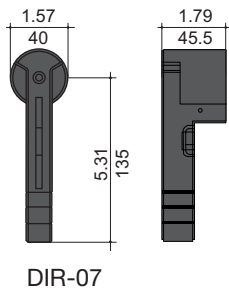

Flange Handle

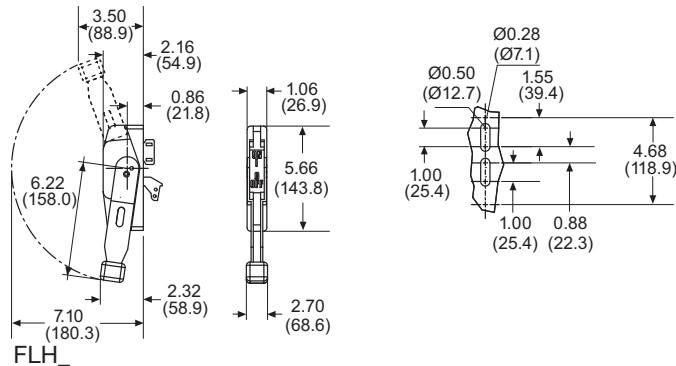

External Front & Right Side Pistol Handle

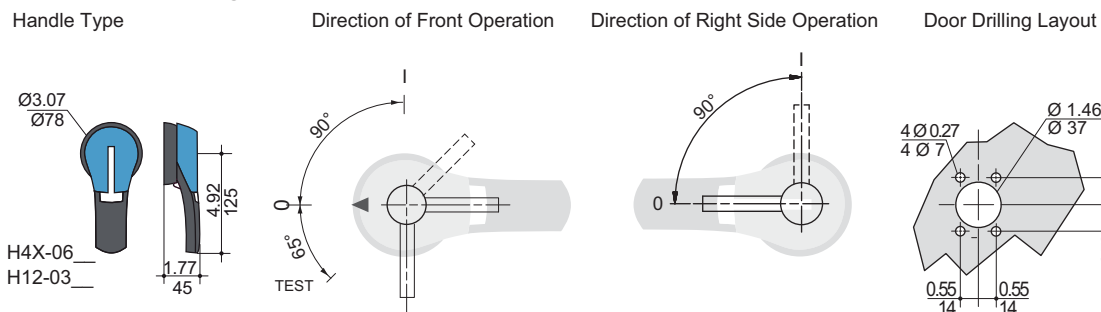

Disconnect Switches

UL 98 Fused Rotary Disconnect Switches—200 & 400A Standard Class J

For a Complete Assembly, Please Select:

SWITCH + LUGS	 + 	Switch										
		Amp Rating	Fuse Class	Number of Poles	SCCR	Max Horsepower Rating				DC*		Part Number
						1-Phase 220/240Vac	220/240Vac	440/480Vac	600 Vac	125 Vdc	250 Vdc	
		200	J	2	200kA	10	-	-	-	-	-	RDF200J-2
		200	J	3	200kA	-	60	125	150	-	-	RDF200J-3
		200	J	4	200kA	-	60	125	150	-	-	RDF200J-4
		400	J	2	200kA	10	-	-	-	20	50	RDF400J-2
		400	J	3	200kA	-	125	250	350	20	50	RDF400J-3
		400	J	4	200kA	-	125	250	350	20	50	RDF400J-4
		* DC Ratings use two poles in series.										
Terminal Lug Kit												
Switch Amp Rating	Number of Poles	Lugs Per Kit	Wire Range			Wire Type		Part Number				
200	2	2	#6-300MCM			75°C Cu/Al		LUG1-2				
200	3	3	#6-300MCM			75°C Cu/Al		LUG1-3				
200	4	4	#6-300MCM			75°C Cu/Al		LUG1-4				
400	2	2	#4-600MCM or Dual 1/0-250MCM			75°C Cu/Al		LUG2-2				
400	3	3	#4-600MCM or Dual 1/0-250MCM			75°C Cu/Al		LUG2-3				
400	4	4	#4-600MCM or Dual 1/0-250MCM			75°C Cu/Al		LUG2-4				
+												
	Direct Mount Handle - mounts directly to switch, no shaft required											
	For Switch Part Number	Color	Test Function	Padlockable						Part Number		
	All Switches	Black	Y	Y						DIR-07		
OR												
HANDLE	 or  + 	External Front Operated Pistol Handles - shaft required										
		NEMA Type	Color	Test Function	Padlockable	Defeatable	Part Number					
		1, 3R, 12	Black	N	Y	Y	H12-03B					
		1, 3R, 12	Red/Yellow	N	Y	Y	H12-03R					
		1, 3R, 4, 4X, 12	Black	N	Y	Y	H4X-06B					
		1, 3R, 4, 4X, 12	Red/Yellow	N	Y	Y	H4X-06R					
		1, 3R, 4, 4X, 12	Black	Y	Y	Y	H4X-06TB					
		1, 3R, 4, 4X, 12	Red/Yellow	Y	Y	Y	H4X-06TR					
		Metallic Hasp (Heavy Duty) External Front Operated Pistol Handles - shaft required										
		NEMA Type	Color	Test Function	Padlockable	Defeatable	Part Number					
1, 3R, 4, 4X, 12	Black	N	Y	Y	H4X-06BHD							
1, 3R, 4, 4X, 12	Red/Yellow	N	Y	Y	H4X-06RHD							
External Right Side Operated Pistol Handles - shaft required												
NEMA Type	Color	Test Function	Padlockable	Defeatable	Part Number							
1, 3R, 4, 4X, 12	Black	N	Y	N/A	H4X-06SB							
1, 3R, 4, 4X, 12	Red/Yellow	N	Y	N/A	H4X-06SR							
Shafts for Pistol Handles												
Length in (mm)	Mounting Depth (X) in (mm)									Part Number		
7.9 (200)	200A: 5.70-9.06 (145-230) 400A: 7.87-10.24 (200-260)									SH5-200		
12.6 (320)	200A: 5.70-13.78 (145-350) 400A: 7.87-16.93 (200-380)									SH5-320		
15.7 (400)	200A: 5.70-16.93 (145-430) 400A: 7.87-18.10 (200-460)									SH5-400		

UL 98 Fused Rotary Disconnect Switches—200 & 400A Standard Class J

Select for Standard Applications		or						
		Flange Handle ⁽¹⁾ 200A Only - requires shaft operated mechanism <i>or</i> cable operated mechanism + cable	NEMA Type	Flange Style	Test Function	Padlockable	Defeatable	Part Number
HANDLE		1, 3R, 4, 12	Standard	N	Y	Y	FLH1	
		1, 3R, 4, 4X, 12	Chrome Plated	N	Y	Y	FLH2	
		Shaft Operated Flange Mechanism⁽²⁾ 200A Only - includes shaft						
		For Enclosure Depth in (mm)					Part Number	
		6-24 (152-613)				FLRM		
		Cable Operated Flange Mechanism and Cable 200A Only - must select Mechanism ⁽³⁾ <i>and</i> Cable ⁽⁴⁾						
		Item				Part Number		
		Cable Mechanism				FLCM		
		36" (900mm) Cable				FLC36		
		60" (1500mm) Cable				FLC60		
		120" (3000mm) Cable				FLC120		
Accessories		or						
		NFPA Through the Door Handle Kit - to be used with front pistol handle						
AUX CONTACTS		Use with Switch	Color	Test Function	Padlockable	Defeatable	Part Number	
		RDF200J-__	Red	N	Y	N	H79-2	
		RDF400J-__	Red	N	Y	N	H79-3	
		and ...						
SHROUDS		Auxiliary Contacts						
		Contact Type	Number of Contacts	Continuous Amp Rating	Voltage Rating	Max Number of Aux Contacts per Switch	Part Number	
		NO	1	10A	600Vac	RDF200J-__: 4	BAC05	
		NC	1	10A	600Vac	RDF400J-__: 8	BAC06	
		and ...						
		Terminal Shrouds - includes terminal shroud for lineside or loadside						
		Switch Amp Rating	Number of Poles				Part Number	
		200	2				TSH8-2TB	
		200	3				TSH8-3TB	
		200	4				TSH8-4TB	
		400	2				TSH9-2TB	
		400	3				TSH9-3TB	
		400	4				TSH9-4TB	

Disconnect Switches

Dimensions – in (mm)

• RDF200J-3

• RDF400J-3

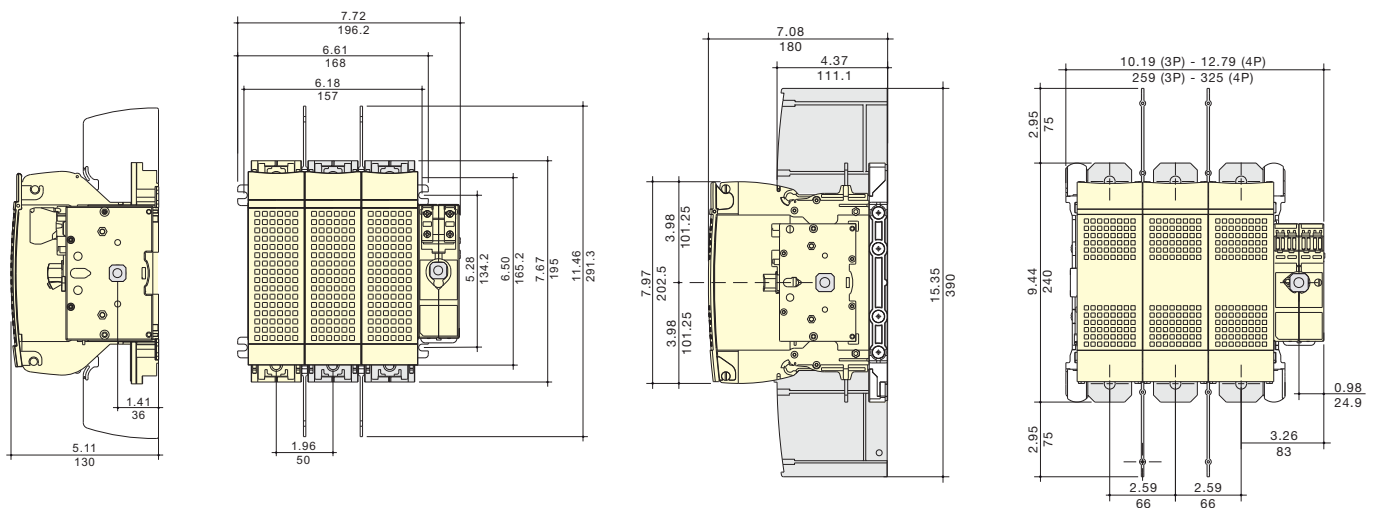

UL 98 Fused Rotary Disconnect Switches—200 & 400A Standard Class J

Direct Mount Handle

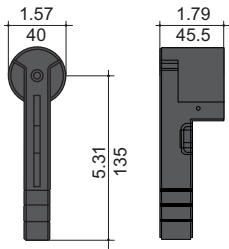

DIR-07

Flange Handle

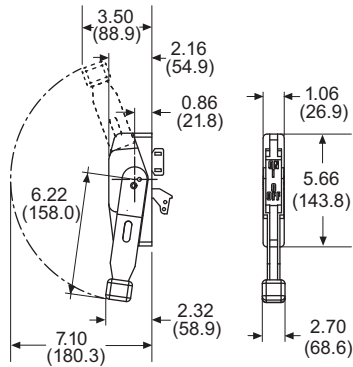

FLH_

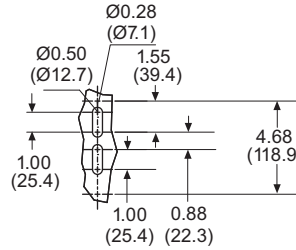

External Front & Right Side Pistol Handle

Handle Type

Direction of Front Operation

Direction of Right Side Operation

Door Drilling Layout

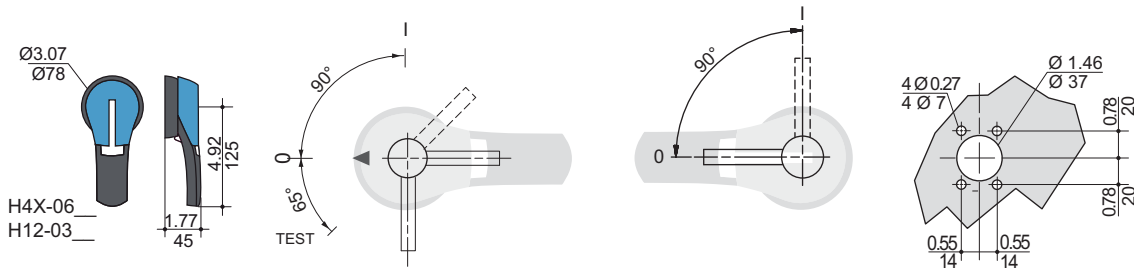

Terminal Lugs

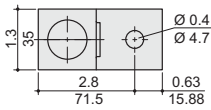
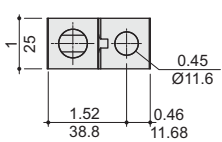

200A

LUG1-__



400A

LUG2-__



Disconnect
Switches

Open & Enclosed Rotary Disconnect Switches In-Stock and Ship Within 24 Hours

The Bussmann QuikShip Everyday Service ensures the most common open and enclosed rotary disconnect switches ship within 24 hours to help you meet project timelines.

Contact your Bussmann representative for details.



QuikShip 
Everyday

www.cooperbussmann.com/Disconnects

UL 98 Fused Rotary Disconnect Switches—600 & 800A

Standard Class J & Class L

For a Complete Assembly, Please Select:

Select for Standard Applications		Switch							
		Amp Rating	Fuse Class	Number of Poles	SCCR	Max Horsepower Rating, 3-Phase			Part Number
						220/240Vac	440/480Vac	600Vac	
		600	J	2	200kA	-	-	-	RDF600J-2
		600	J	3	200kA	200	400	500	RDF600J-3
		600	J	4	200kA	200	400	500	RDF600J-4
		800	L	2	200kA	-	-	-	RDF800L-2
		800	L	3	200kA	200	500	500	RDF800L-3
		800	L	4	200kA	200	500	500	RDF800L-4
		Terminal Lug Kit							
Switch Amp Rating	Number of Poles	Lugs Per Kit	Wire Range			Wire Type	Part Number		
600-800	2	2	(2) #2-600MCM			75°C Cu/Al	LUG5-2		
600-800	3	3	(2) #2-600MCM			75°C Cu/Al	LUG5-3		
600-800	4	4	(2) #2-600MCM			75°C Cu/Al	LUG5-4		
+									
Accessories		Direct Mount Handle - mounts directly to switch, no shaft required						Part Number	
		For Switch Part Number	Color	Test Function	Padlockable			Part Number	
		All Switches	Black	Y	Y			DIR-08	
		OR							
		External Front Operated Pistol Handles - shaft required						Part Number	
		NEMA Type	Color	Test Function	Padlockable	Defeatable			Part Number
		1, 3R, 4, 4X, 12	Black	N	Y	Y			H4X-07B
		1, 3R, 4, 4X, 12	Red/Yellow	N	Y	Y			H4X-07R
		Metallic Hasp (Heavy Duty) External Front Operated Pistol Handles - shaft required						Part Number	
		NEMA Type	Color	Test Function	Padlockable	Defeatable			Part Number
1, 3R, 4, 4X, 12	Black	N	Y	Y			H4X-07BHD		
1, 3R, 4, 4X, 12	Red/Yellow	N	Y	Y			H4X-07RHD		
Shafts for Pistol Handles						Part Number			
Length in (mm)	Mounting Depth (X) in (mm)					Part Number			
7.9 (200)	10.63~11.97 (270~304)					SH7-200			
12.6 (320)	10.63~16.69 (270~424)					SH7-320			
15.7 (400)	10.63~19.84 (270~504)					SH7-400			
OR									
NFPA Through the Door Handle Kit - to be used with front pistol handle						Part Number			
For Switch Part Number	Color	Test Function	Padlockable	Defeatable			Part Number		
All Switches	Red	N	Y	N			H79-4		
and ...									
Accessories		Auxiliary Contacts							
		Contact Type	Number of Contacts	Continuous Amp Rating	Voltage Rating	Max Number of Aux Contacts per Switch	Part Number		
		NO	1	10A	600Vac	8	BAC05		
		NC	1	10A	600Vac	8	BAC06		
		and ...							
		Terminal Shrouds - includes terminal shroud for lineside or loadside						Part Number	
		Switch Amp Rating	Number of Poles					Part Number	
		600-800	2					TSH10-2TB	
		600-800	3					TSH10-3TB	
		600-800	4					TSH10-4TB	

UL 98 Fused Rotary Disconnect Switches—600 & 800A

Standard Class J & Class L

Dimensions – in (mm)

- RDF600J-3 • RDF800L-3

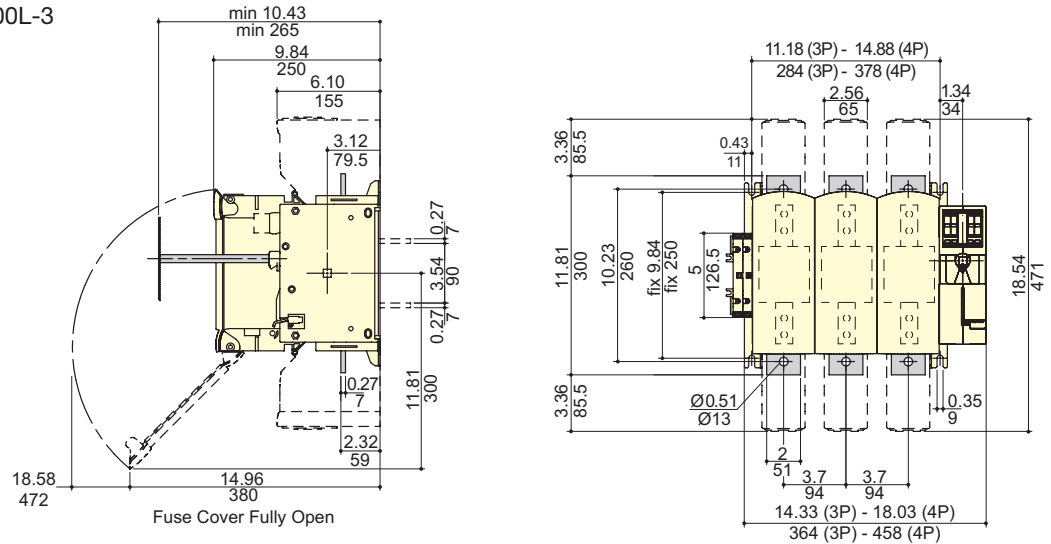

Direct Mount Handle

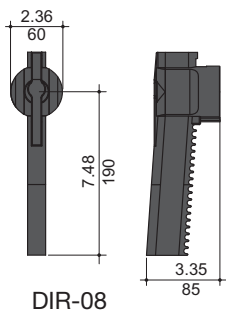

External Front Pistol Handle

Handle Type

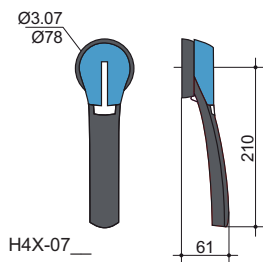

Direction of Front Operation

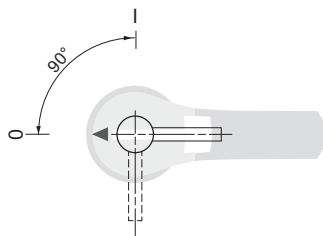

Door Drilling Layout

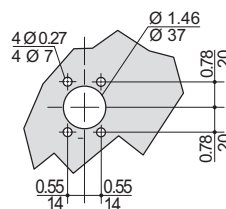

Terminal Lugs

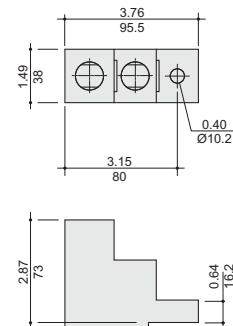

600 to 800A

LUG5-__

Disconnect
Switches

UL 98 Non-Fused Rotary Disconnect Switches—30 to 1200A

Description

Bussmann UL 98 non-fused rotary disconnect switches are versatile switches that “break” and “make” power circuits ON and OFF load.

Features

- Make and break power under load
- Up to 200kA SCCR
- DIN-Rail or panel mount (30-100A)
- Disconnect switches are front, right side and direct handle operable (30-100A)
- Finger-safe (30-100A)
- Fully visualized breaking (100-1200A)

Agency Information

- UL98, Guide WHTY, File E155130
- CSA 22.2 No. 4, File 257020
- Conforms with IEC 60947-3

Online Resources

Visit www.cooperbussmann.com/Disconnects for:

- CAD Drawings
- Instruction Sheets
- UL Information

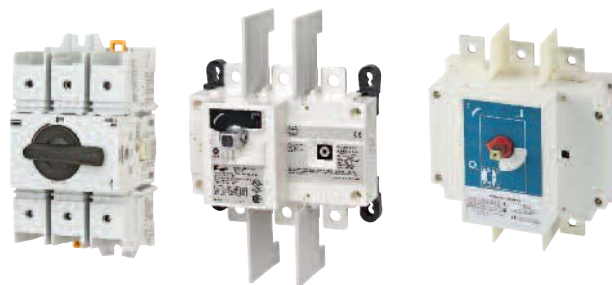

QuikShip Everyday Service ships the most common part numbers within 24 hours. Contact your Bussmann representative for details.

Related Cooper Bussmann Products

Fuse Blocks	Data Sheet #
Modular Knifeblade Fuse Blocks 100-600A	3192
Fuses Holders	
CH Series Class CC, Midget & 10x38 0-30A	3185
Finger-Safe Optima Series 0-30A	1102
Optima™ Protection Modules 0-30A	1109
CH Series Class J 0-60A	2144

IEC Electrical Specifications



Part Number	RD30-3	RD60-3	RD100-3	RD100-3-SCCR	RD200-3	RD400-3	RD600-3	RD800-3	RD1000-3	RD1200-3
3-Pole	RD30-3	RD60-3	RD100-3	RD100-3-SCCR	RD200-3	RD400-3	RD600-3	RD800-3	RD1000-3	RD1200-3
4-Pole	—	—	—	—	RD200-4	RD400-4	RD600-4	RD800-4	RD1000-4	RD1200-4
Thermal Current I_{th} @ 40°C (A)	30	60	100	—	—	—	—	—	—	—
Rated insulation voltage U_i (V)	800	800	800	—	—	—	1000	1000	1000	1000
Rated impulse withstand voltage U_{imp} (kV)	8	8	8	—	—	—	12	12	12	12
Rated Operation Currents I_e (A)										
Load Duty Category	A ⁽¹⁾	A ⁽¹⁾	A ⁽¹⁾	—	—	—	A ⁽¹⁾	A ⁽¹⁾	A ⁽¹⁾	A ⁽¹⁾
Rated Voltage	—	—	—	—	—	—	—	—	—	—
400Vac AC-22 A	32	63	100	—	—	—	630	800	1000	1200
400Vac AC-23 A	32	63	100	—	—	—	630	800	1000	1000
690Vac AC-22 A	32	63	80	—	—	—	500	630	630	630
690Vac AC-23 A	32	63	63	—	—	—	200	400	400	400
Operational Power (Vac) in AC-23 (kW)										
400V w/o prebreak AC ⁽¹⁾⁽²⁾	15	30	45	—	—	—	355	450	560	560
500V w/o prebreak AC ⁽¹⁾⁽²⁾	15	30	45	—	—	—	450	560	560	560
690V w/o prebreak AC ⁽¹⁾⁽²⁾	18.5	30	45	—	—	—	185	400	400	400
Overload Capacity (U_e 415Vac)										
Rated short-time making capacity I_{cm} (kA peak) ⁽³⁾	12	12	12	—	—	—	48	75	48	75
Fuse Protected Short-Circuit Withstand (kA rms prospective)										
Short-Circuit Current (kA) ⁽³⁾	50	50	25	—	—	—	100	100	100	100
Associated Fuse Rating (A) ⁽³⁾	32	63	100	—	—	—	630	800	1000	1250
Connection										
Minimum Cu cable cross section (mm ²)	2.5	2.5	10	—	—	—	2x150	2x185	2x240	—
Minimum Cu busbar section (mm ²)	—	—	—	—	—	—	2x30x5	2x40x5	2x50x5	2x60x5
Maximum Cu cable section (mm ²)	70	70	70	—	—	—	—	—	—	—

(1) A/B: Category with index A = frequent operation; category with index B = infrequent operation.

(2) The power value is given for information only; the current values vary from one manufacturer to another.

(3) For a rated operating voltage, $U_e = 400$ Vac.

UL 98 Non-Fused Rotary Disconnect Switches—30 to 1200A

Specifications



RD30-3



RD200-3



RD600-3







Part Number	RD30-3	RD60-3	RD100-3	RD100-3-SCCR	RD200-3	RD400-3	RD600-3	RD800-3	RD1000-3	RD1200-3
3-Pole	—	—	—	—	RD200-4	RD400-4	RD600-4	RD800-4	RD1000-4	RD1200-4
4-Pole	—	—	—	—	—	—	—	—	—	—
UL Standard	UL 98	UL 98	UL 98	UL 98	UL 98	UL 98	UL 98	UL 98	UL 98	UL 98
Max Ampacity	30A	60A	100A	100A	200A	400A	600A	800A	1000A	1200A
Switch Type	Compact	Compact	Compact	Standard	Standard	Standard	Standard	Standard	Standard	Standard
Handle Operation	Front/Side	Front/Side	Front/Side	Front	Front	Front	Front	Front	Front	Front
UL Electrical Ratings										
Max Voltage (AC)	600Vac	600Vac	600Vac	600Vac	600Vac	600Vac	600Vac	600Vac	600Vac	600Vac
Max Voltage (DC)	—	—	—	250Vdc	250Vdc	—	250Vdc	—	—	—
Maximum AC Horsepower Ratings										
1-Phase, 120Vac	2	3	5	—	—	—	—	—	—	—
1-Phase, 240Vac	5	10	10	10	10	—	—	—	—	—
3-Phase, 240Vac	10	20	20	30	75	125	200	200	200	200
3-Phase, 480Vac	20	40	50	75	150	250	400	500	500	500
3-Phase, 600Vac	25	50	50	100	200	350	350	500	500	500
DC Horsepower Ratings										
125Vdc	—	—	—	—	—	—	20	—	—	—
250Vdc	—	—	—	—	—	—	50	—	—	—
Electrical Characteristics										
SCCR with Fuse	100kA	100kA	25kA/100kA*	200kA	200kA	200kA	200kA	100kA	100kA	100kA
Fuse Class	J	J	J	J	J	J	J	L	L	L
Max. Fuse Rating	30A	60A	100A	100A	200A	400A	600A	800A	1000A	1200A
Terminal Lugs/Kits	Integral	Integral	Integral	•	•	•	•	•	•	•
Lug Mounting Torque - Lb-In (N•m)	-	-	-	160 (18)	160 (18)	LUG2-... 310 (35) LUG3-... 398 (45)	310 (35)	310 (35)	310 (35)	310 (35)
Wire Type	75°C Cu	75°C Cu	75°C Cu	75°C Cu/Al	75°C Cu/Al	75°C Cu/Al	75°C Cu/Al	75°C Cu/Al	75°C Cu/Al	75°C Cu/Al
Wire Range & Torque - Lb-In (N•m)										
Solid	#12-10 35.4 (4)	#12-10 35.4 (4)	#12-10 35.4 (4)	—	—	—	—	—	—	—
Stranded	#10-1 35.4 (4) 1/0 39.8 (4.5) 2/0 44.3 (5)	#10-1 35.4 (4) 1/0 39.8 (4.5) 2/0 44.3 (5)	#10-1 35.4 (4) 1/0 39.8 (4.5) 2/0 44.3 (5)	#6-300MCM 275 (31)	#6-300MCM 275 (31)	LUG2-... #4-600MCM 550 (62) Dual 1/0-250MCM 550 (62) LUG3-... (2) #6-2 200 (22.6) (2) #1-350MCM 375 (42.4)	(2) #2-600MCM 375 (42.4)	(4) #2-600MCM 375 (42.4)	(4) #2-600MCM 375 (42.4)	(4) #2-600MCM 375 (42.4)
Mechanical Characteristics										
Endurances/Cycles	10,000	10,000	10,000	10,000	8000	6000	6000	3500	3500	3500
Physical Characteristics										
Dimensions	See drawings on product pages									
Weight - Lbs (KG)										
3-Pole	1.3 (0.6)	1.3 (0.6)	1.3 (0.6)	4.2 (1.91)	4.2 (1.91)	10.0 (4.6)	18.1 (8.2)	19.6 (8.9)	19.6 (8.9)	19.6 (8.9)
4-Pole	—	—	—	—	5.0 (2.3)	12.3 (5.6)	23.9 (10.9)	25.3 (11.5)	25.3 (11.5)	25.3 (11.5)
Environmental										
Operating Temperature	-20°C to 70°C	-20°C to 70°C	-20°C to 70°C	-20°C to 70°C	-20°C to 70°C	-20°C to 70°C	-20°C to 70°C	-20°C to 70°C	-20°C to 70°C	-20°C to 70°C
Flammability Rating	UL 94-V0	UL 94-V0	UL 94-V0	UL 94-V0	UL 94-V0	UL 94-V0	UL 94-V0	UL 94-V0	UL 94-V0	UL 94-V0
Accessories										
Lug Kit Part #										
3-Pole	Integral	Integral	Integral	•	•	•	•	•	•	•
4-Pole	—	—	—	—	—	—	—	—	—	—
Handles										
NEMA 1, 3R, 12	•	•	•	•	•	•	—	—	—	—
NEMA 1, 3R, 4, 4X, 12	•	•	•	•	•	•	•	•	•	•
Direct	•	•	•	•	•	•	•	•	•	•
Front Pistol	—	—	—	•	•	•	•	•	•	•
Front or Side Selector	•	•	•	—	—	—	—	—	—	—
Shaft c/s - mm	5x5	5x5	5x5	10x10	10x10	10x10	12x12	12x12	12x12	12x12
Shaft Guide	•	•	•	•	•	•	•	•	•	•
Shrouds	•	•	•	•	•	•	•	•	•	•
Additional Pole Accessory	•	•	•	—	—	—	—	—	—	—
Auxiliary Contacts										
NO + NC	•	•	•	•	•	•	•	•	•	•
(2) NO	•	•	•	—	—	—	—	—	—	—

Disconnect Switches

• Available, see product page for details and part numbers.
 — Not available.
 * 25kA @ 600Vac, 100kA @ 480Vac.

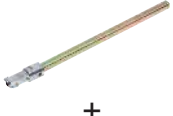
UL 98 Non-Fused Rotary Disconnect Switches—30, 60 and Compact 100A

For a Complete Assembly, Please Select:

Select for Standard Applications	SWITCH		Switch										
			Switch Amp Rating	No. of Poles	SCCR	Max Horsepower Rating					Wire Size	Wire Type	Part Number
						1-Phase		3-Phase					
						120 Vac	220/240Vac	220/240Vac	440/480Vac	600 Vac			
	30	3	100kA	2	5	10	20	25	#10-2/0 Str #12-10 Sol	75°C Cu	RD30-3		
	60	3	100kA	3	10	20	40	50	#10-2/0 Str #12-10 Sol	75°C Cu	RD60-3		
	100	3	25/100kA*	5	10	20	50	50	#10-2/0 Str #12-10 Sol	75°C Cu	RD100-3		
	* 100kA @480Vac, 25kA @ 600Vac.												
	Accessories	HANDLES		Direct Mount Handle - mounts directly to switch, no shaft required								Part Number	
				For Switch Part Number	Color		Test Function	Padlockable					
All Switches		Black		N	Y - On Switch				DIR-02				
OR													
HANDLES			External Front or Right Side Operated Selector Handles - shaft required								Part Number		
			NEMA Type	Color	Handle Length	Test Function	Padlockable	Defeatable					
1, 3R, 4, 4X, 12		Black	Short	N	Y	Y		H4X-01B ⁽¹⁾					
1, 3R, 4, 4X, 12		Red/Yellow	Short	N	Y	Y		H4X-01R ⁽¹⁾					
1, 3R, 4, 4X, 12		Black	Long	N	Y	Y		H4X-02B ⁽²⁾					
1, 3R, 4, 4X, 12		Red/Yellow	Long	N	Y	Y		H4X-02R ⁽²⁾					
HANDLES		Shafts for Selector Handles								Part Number			
		Length in (mm)	Mounting Depth (X) in (mm)										
		5.9 (150)	3.50~7.60 (89~193)						SH4-150				
		7.9 (200)	3.50~9.50 (89~241)						SH4-200				
	12.6 (320)	3.50~14.9 (89~378)					SH4-320						
HANDLES		Shaft Guide								Part Number			
		Required for 12.6" (320mm) long shafts, optional for other lengths									SH-GUIDE1		
Accessories	AUX CONTACTS		Auxiliary Contacts						Part Number				
			Contact Type	Number of Contacts	Continuous Amp Rating	Voltage Rating	Max Number of Aux Contacts per Switch						
			NO + NC	1 of each	10A	240Vac	4	BAC01					
SHROUDS		Terminal Shrouds - includes terminal shroud for both lineside and loadside											
		Switch Amp Rating		Number of Poles		Location on Switch		Part Number					
		All Switches		1 (for switched 4 th pole)		Lineside and Loadside		TSH3-1TB					
All Switches		3		Lineside and Loadside		TSH3-3TB							
SW. 4 TH POLE		Switched 4th Pole - converts 3-pole switch to 4-pole											
		Switch Amp Rating							Part Number				
		30							POLE98-30				
		60							POLE98-60				
100							POLE98-100						



Auxiliary Contact Configurations

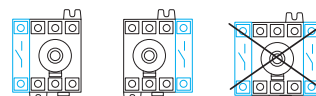

Possible 4th Pole Configurations

UL 98 Non-Fused Rotary Disconnect Switches—30, 60 and Compact 100A

Dimensions - in (mm)

Direct Handle Operation

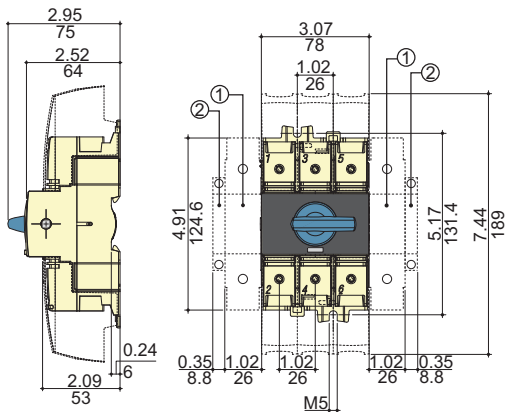

External Front Operation

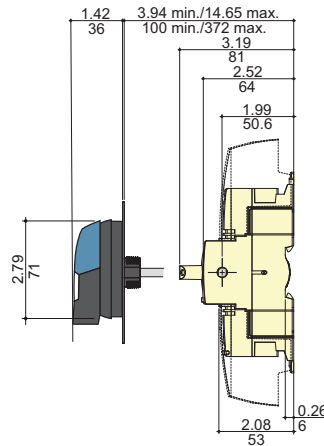

External Right Side Operation

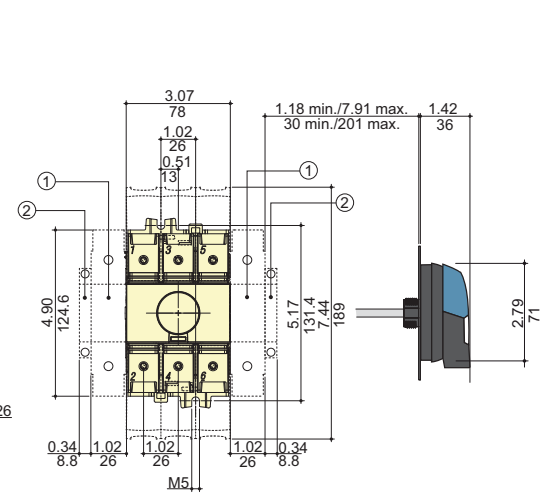

1. Position for 1 switched 4th pole (1 per device max.) or 1 auxiliary contact.
 2. Position for 1 auxiliary contact only.
- Note: Maximum of 4 auxiliary contacts, or 3 auxiliary contacts + one switched 4th pole.

Disconnect
Switches

External Front or Right Side Operated Selector Handle

Handle Type

Direction of Front Operation Direction of Right Side Operation



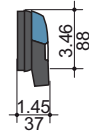
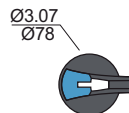
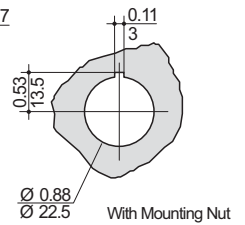
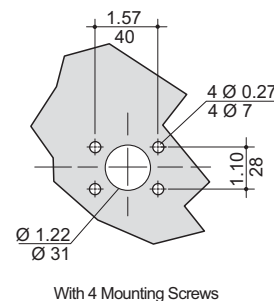
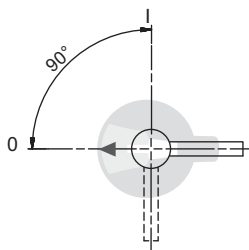
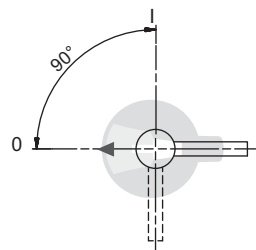
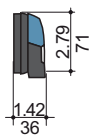
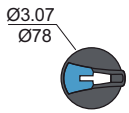



Door Drilling Layouts



H4X-02_

UL 98 Non-Fused Rotary Disconnect Switches—100, 200 and 400A

For a Complete Assembly, Please Select:

SWITCH + LUGS	 + 	Switch							
		Switch Amp Rating	No. of Poles	SCCR	Max Horsepower Rating				Part Number
					1-Phase 220/240Vac	220/240Vac	3-Phase 440/480Vac	600 Vac	
		100	3	200kA	10	30	75	100	RD100-3-SCCR
		200	3	200kA	10	75	150	200	RD200-3
		200	4	200kA	10	75	150	200	RD200-4
		400	3	200kA	-	125	250	350	RD400-3
		400	4	200kA	-	125	250	350	RD400-4
		Terminal Lug Kit							
		Switch Amp Rating	No. of Poles	Lugs Per Kit	Wire Range			Wire Type	Part Number
100-200	2	2	#6-300MCM			75°C Cu/Al	LUG1-2		
100-200	3	3	#6-300MCM			75°C Cu/Al	LUG1-3		
100-200	4	4	#6-300MCM			75°C Cu/Al	LUG1-4		
400	2	2	#4-600MCM or Dual 1/0-250MCM			75°C Cu/Al	LUG2-2		
400	3	3	#4-600MCM or Dual 1/0-250MCM			75°C Cu/Al	LUG2-3		
400	4	4	#4-600MCM or Dual 1/0-250MCM			75°C Cu/Al	LUG2-4		
400	2	2	(2) #6-350MCM			75°C Cu/Al	LUG3-2		
400	3	3	(2) #6-350MCM			75°C Cu/Al	LUG3-3		
400	4	4	(2) #6-350MCM			75°C Cu/Al	LUG3-4		
HANDLE	 +  or  +  + 	Direct Mount Handle - mounts directly to switch, no shaft required							
		For Switch Part Number	Color	Test Function	Padlockable			Part Number	
		All Switches	Black	N	Y			DIR-03	
		OR							
		External Front Operated Pistol Handles - shaft required							
		NEMA Type	Color	Test Function	Padlockable	Defeatable			Part Number
		1, 3R, 12	Black	N	Y	Y			H12-03B
		1, 3R, 12	Red/Yellow	N	Y	Y			H12-03R
		1, 3R, 4, 4X, 12	Black	N	Y	Y			H4X-06B
		1, 3R, 4, 4X, 12	Red/Yellow	N	Y	Y			H4X-06R
Metallic Hasp (Heavy Duty) External Front Operated Pistol Handles - shaft required									
NEMA Type	Color	Test Function	Padlockable	Defeatable			Part Number		
1, 3R, 4, 4X, 12	Black	N	Y	Y			H4X-06BHD		
1, 3R, 4, 4X, 12	Red/Yellow	N	Y	Y			H4X-06RHD		
Shafts for Pistol Handles									
Length in (mm)	Mounting Depth (X) in (mm)					Part Number			
7.9 (200)	5.31~10.43 (135~265)					SH5-200			
12.6 (320)	5.31~15.16 (135~385)					SH5-320			
15.7 (400)	5.31~18.31 (135~465)					SH5-400			
Shaft Guide							Part Number		
Required for 15.7" (400mm) long shafts, optional for other lengths						SH-GUIDE2			
and ...									
ACCESSORIES		Auxiliary Contacts							
		Contact Type	Number of Contacts	Continuous Amp Rating	Voltage Rating	Max Number of Aux Contacts per Switch	Part Number		
		NO + NC	1 of each	10.1A	125-250Vac	2	BAC03*		
		NO + NC	1 of each	10.1A	125-250Vac	2	BAC04*		
		NO + NC	1 of each	1A	125Vac	2	BAC11*		
		NO + NC	1 of each	1A	125Vac	2	BAC12*		
		* For one auxiliary contact, install either BAC03 or BAC11. For two auxiliary contacts, install BAC03 + BAC04, or BAC11 + BAC12.							

UL 98 Non-Fused Rotary Disconnect Switches—100, 200 and 400A

and ...

Accessories SHROUDS		Terminal Shrouds - includes terminal shroud for lineside or loadside			
		Switch Amp Rating	Number of Poles	Location on Switch	Part Number
		100-200A	3	Lineside	TSH4-3T
		100-200A	3	Loadside	TSH4-3B
		100-200A	4	Lineside or Loadside	TSH4-4TB
		400A	3	Lineside	TSH5-3T
		400A	3	Loadside	TSH5-3B
		400A	4	Lineside or Loadside	TSH5-4TB

Dimensions - in (mm)

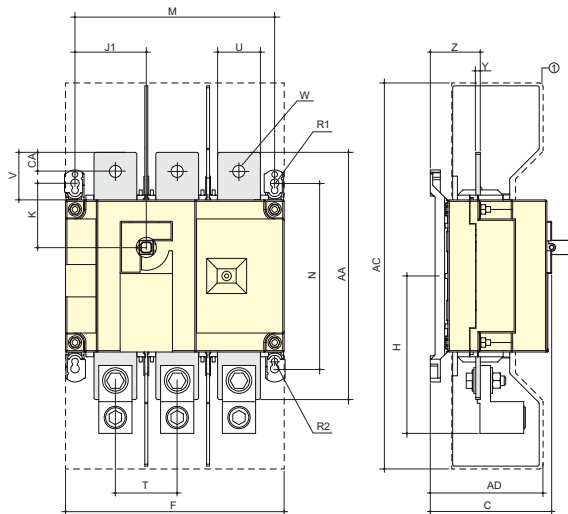

Terminal Lugs

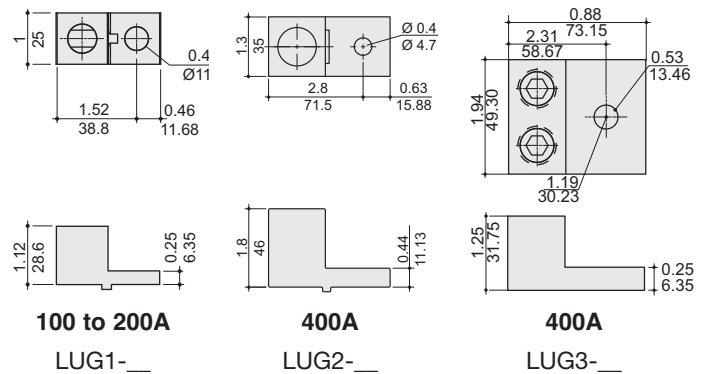

Disconnect Switches

Switch Rating (A)	Overall Dimen. C	Terminal Shrouds		Switch Body						Switch Mounting				Connection								
		AC	AD	F 3p.	F 4p.	H	J1 3p.	J1 4p.	K	M 3p.	M 4p.	N	R1	R2	T	U	V	W	Y	Z	AA	AC
100	3.72 (94.6)	10.1 (256)	3.05 (77.5)	7.09 (180)	9.06 (230)	4.22 (107)	2.17 (55)	4.13 (105)	1.8 (45.6)	6.3 (160)	8.27 (210)	5.31 (135)	0.35 (9)	0.27 (7)	1.97 (50)	0.98 (25)	1.18 (30)	0.43 (11)	0.14 (3.5)	1.35 (34.4)	6.3 (160)	0.6 (15)
200	3.72 (94.6)	10.1 (256)	3.05 (77.5)	7.09 (180)	9.06 (230)	4.22 (107)	2.17 (55)	4.13 (105)	1.8 (45.6)	6.3 (160)	8.27 (210)	5.31 (135)	0.35 (9)	0.27 (7)	1.97 (50)	0.98 (25)	1.18 (30)	0.43 (11)	0.14 (3.5)	1.35 (34.4)	6.3 (160)	0.6 (15)
400	4.92 (128)	16 (406)	4.15 (115)	9.05 (230)	11.4 (290)	6.53 (166)	2.95 (75)	5.31 (135)	2.65 (67.5)	8.26 (210)	10.6 (270)	7.67 (195)	0.35 (9)	0.27 (7)	2.56 (65)	1.77 (45)	1.97 (50)	0.43 (13)	0.2 (5)	2.08 (53)	10.2 (260)	0.8 (20)

Direct Mount Handle

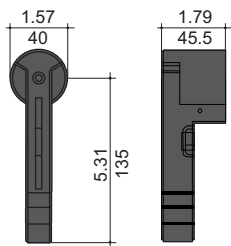

DIR-03

External Front Handle

Handle Type



Direction of Front Operation

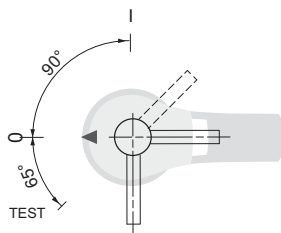

Door Drilling Layout

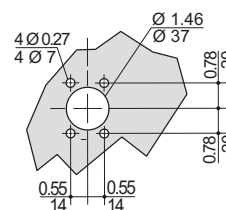

UL 98 Non-Fused Rotary Disconnect Switches—600, 800, 1000 and 1200A

For a Complete Assembly, Please Select:

SWITCH + LUGS		Switch							Part Number		
		Switch Amp Rating	No. of Poles	SCCR	Max Horsepower Rating						
					3-Phase			DC*			
					220/240Vac	440/480Vac	600 Vac	125 Vdc		250 Vdc	
		600A	3	200kA	240	400	350	20		50	RD600-3
		600A	4	200kA	240	400	350	20		50	RD600-4
		800A	3	100kA	200	500	500	-		-	RD800-3
		800A	4	100kA	200	500	500	-		-	RD800-4
		1000A	3	100kA	200	500	500	-		-	RD1000-3
		1000A	4	100kA	200	500	500	-		-	RD1000-4
1200A	3	100kA	200	500	500	-	-	RD1200-3			
1200A	4	100kA	200	500	500	-	-	RD1200-4			
* DC Ratings use two poles in series.											
SELECT FOR STANDARD APPLICATIONS		Terminal Lug Kit							Part Number		
		Switch Amp Rating	No. of Poles	Lugs Per Kit	Lugs Required per Pole	Wire Range	Wire Type				
		600	3	3	1	(2) #2-600MCM	75°C Cu/Al	LUG5-3			
		600	4	4	1	(2) #2-600MCM	75°C Cu/Al	LUG5-4			
		800-1200	3	6	2	(4) #2-600MCM	75°C Cu/Al	LUG6-6			
		800-1200	4	8	2	(4) #2-600MCM	75°C Cu/Al	LUG6-8			
		+									
		HANDLE		Direct Mount Handle - mounts directly to switch, no shaft required						Part Number	
				For Switch Part Number	Color	Test Function	Padlockable				
	All Switches	Black	N	Y			DIR-04				
or											
HANDLE		External Front Operated Pistol Handles - shaft required							Part Number		
		NEMA Type	Color	Test Function	Padlockable	Defeatable					
		1, 3R, 4, 4X, 12	Black	N	Y	Y	H4X-07B ⁽¹⁾				
		1, 3R, 4, 4X, 12	Red/Yellow	N	Y	Y	H4X-07R ⁽¹⁾				
		1, 3R, 4, 4X, 12	Black	N	Y	Y	H4X-08B ⁽²⁾				
		1, 3R, 4, 4X, 12	Red/Yellow	N	Y	Y	H4X-08R ⁽²⁾				
		Metallic Hasp (Heavy Duty) External Front Operated Pistol Handles - shaft required									
		NEMA Type	Color	Test Function	Padlockable	Defeatable	Part Number				
		1, 3R, 4, 4X, 12	Black	N	Y	Y	H4X-07BHD ⁽³⁾				
		1, 3R, 4, 4X, 12	Red/Yellow	N	Y	Y	H4X-07RHD ⁽³⁾				
1, 3R, 4, 4X, 12	Black	N	Y	Y	H4X-08BHD ⁽⁴⁾						
1, 3R, 4, 4X, 12	Red/Yellow	N	Y	Y	H4X-08RHD ⁽⁴⁾						
Shafts for Pistol Handles											
Length in (mm)	Mounting Depth (X) in (mm)					Part Number					
7.9 (200)	8.70~13.50 (221~343)					SH6-200					
12.6 (320)	8.70~18.23 (221~463)					SH6-320					
15.7 (400)	8.70~21.38 (221~543)					SH6-400					
Shaft Guide											
	Required for 15.7" (400mm) long shafts, optional for other lengths					Part Number					
						SH-GUIDE2					
and ...											
ACCESSORIES		Auxiliary Contacts									
		Contact Type	Number of Contacts	Continuous Amp Rating	Voltage Rating	Max Number of Aux Contacts per Switch	Part Number				
		NO + NC	1 of each	10.1A	125-250Vac	2	BAC03*				
		NO + NC	1 of each	10.1A	125-250Vac	2	BAC04*				
		NO + NC	1 of each	1A	125Vac	2	BAC11*				
		NO + NC	1 of each	1A	125Vac	2	BAC12*				
* For one auxiliary contact, install either BAC03 or BAC11. For two auxiliary contacts, install BAC03 + BAC04, or BAC11 + BAC12.											

UL 98 Non-Fused Rotary Disconnect Switches—600, 800, 1000 and 1200A

Accessories	SHROUDS	Terminal Shrouds* - includes terminal shroud for lineside or loadside			
		Switch Amp Rating	Number of Poles	Location on Switch	Part Number
		600A	3	Lineside or Loadside	TSH6-3TB
		600A	4	Lineside or Loadside	TSH6-4TB
		800-1200A	3	Lineside or Loadside	TSH7-3TB
		800-1200A	4	Lineside or Loadside	TSH7-4TB

* Shroud for lineside included with switch.

Dimensions - in (mm) 600A

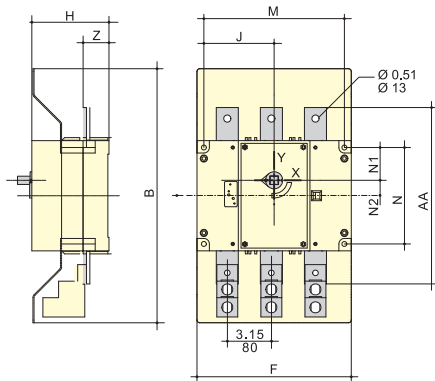

800 to 1200A

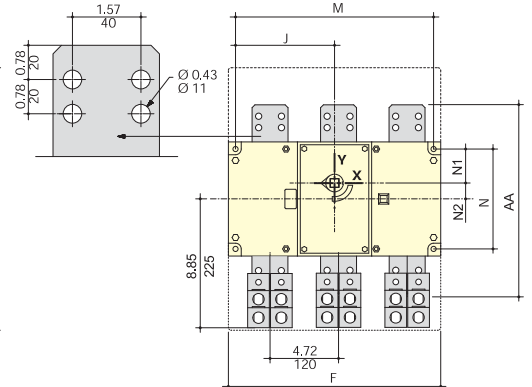

Switch Rating (A)	Terminal Shrouds B	Switch Body				Switch Mounting						Connection	
		F 3p.	F 4p.	H	J 3p.	J 4p.	M 3p.	M 4p.	N	N1	N2	AA	Z
600	18.12 (460)	11 (280)	14.17 (360)	5.5 (140)	5 (127.5)	6.59 (167.5)	10.03 (255)	13.19 (335)	6.88 (175)	2.34 (59.5)	1.10 (28)	12.6 (320)	1.85 (47)
800	18.12 (460)	14.64 (372)	19.37 (492)	5.5 (140)	6.83 (173.5)	9.19 (233.5)	13.66 (347)	18.38 (467)	6.88 (175)	2.34 (59.5)	1.10 (28)	13 (330)	1.85 (47)
1000	18.12 (460)	14.64 (372)	19.37 (492)	5.5 (140)	6.83 (173.5)	9.19 (233.5)	13.66 (347)	18.38 (467)	6.88 (175)	2.34 (59.5)	1.10 (28)	13 (330)	1.85 (47)
1200	18.12 (460)	14.64 (372)	19.37 (492)	5.5 (140)	6.83 (173.5)	9.19 (233.5)	13.66 (347)	18.38 (467)	6.88 (175)	2.34 (59.5)	1.10 (28)	13 (330)	1.85 (47)

External Front Pistol Handles

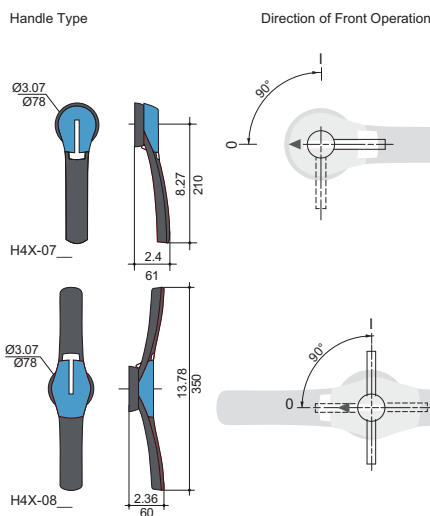

Direct Mount Handle

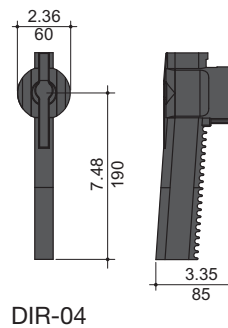

Terminal Lugs

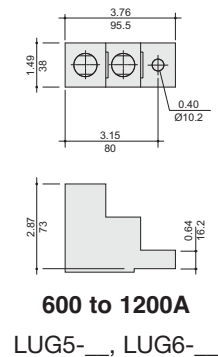

UL 508 Non-Fused Rotary Disconnect Switches—16 to 80A

Description

Bussmann UL 508 load break disconnect switches allow safe control and safe disconnection of any motor application or to isolate a circuit within the panel.

These disconnect switches are compact and offer a wide variety of accessories like 4th poles, auxiliary contacts, door mounting and 6/8-Pole kits.

Features

- Suitable as motor disconnect
- DIN-Rail or panel mount
- Door mount option
- Disconnect switches are front, right side or direct handle operable
- Finger-safe

Agency Information

- UL508, Guide NLRV, File E155129
- CSA C22.2 No. 14, File 257020
- Conforms with IEC 60947-3

Online Resources

Visit www.cooperbussmann.com/Disconnects for:

- CAD Drawings
- Instruction Sheets
- UL Information



QuikShip
Everyday

QuikShip Everyday Service ships the most common part numbers within 24 hours. Contact your Bussmann representative for details.

Related Cooper Bussmann Products	
Product	Data Sheet #
Fuses Blocks	
Modular Knifeblade Fuse Blocks 100-600A	3192
Fuses Holders	
CH Series Class CC, Midget & 10x38 0-30A	3185
Finger-Safe Optima Series 0-30A	1102
Optima™ Protection Modules 0-30A	1109
CH Series Class J 0-60A	2144

IEC Electrical Specifications		RD16-3-508		RD16-3-508 with 6-Pole Conversion Kit		
Part Number		RD16-3-508	RD25-3-508	RD40-3-508	RD63-3-508	RD80-3-508
Thermal Current I_{th} at 40°C (A)		16	25	40	63	80
Rated insulation voltage U_i (V)		800	800	800	800	800
Rated impulse withstand voltage U_{imp} (kV)		8	8	8	8	8
Rated Operation Currents I_o (A)						
Load Duty Category	Rated Voltage	A/B ⁽¹⁾	A/B ⁽¹⁾	A/B ⁽¹⁾	A/B ⁽¹⁾	A/B ⁽¹⁾
500Vac	AC-22 A/AC-22 B	16/16	25/25	40/40	63/63	80/80
500Vac	AC-23 A/AC-23 B	16/16	25/25	25/25	63/63	63/63
690Vac	AC-21 A/AC-21 B	16/16	25/25	40/40	63/63	80/80
690Vac	AC-22 A/AC-22 B	16/16	25/25	32/40	40/63	63/80
690Vac	AC-23 A/AC-23 B	16/16	25/25	25/25	40/40	40/40
Operational Power in AC-23 (kW)						
400Vac without prebreak AC ⁽¹⁾⁽²⁾		7.5	11	18.5	30	37
500Vac without prebreak AC ⁽¹⁾⁽²⁾		7.5	11	15	30	37
690Vac without prebreak AC ⁽¹⁾⁽²⁾		7.5	15	18.5	30	37
Overload Capacity (U_s 415 Vac)						
Rated short-time withstand current 0.3 s. I_{cw} (kA rms) ⁽³⁾		2.5	2.5	2.5	3	3
Rated short-time making capacity I_{cm} (kA peak) ⁽³⁾		6	6	6	9	9
Fuse Protected Short-Circuit Withstand (kA rms Prospective)						
Prospective short-circuit current (kA rms) ⁽³⁾		50	50	50	50	50
Associated fuse rating (A) ⁽³⁾		16	25	40	63	80
Connection						
Minimum Cu cable cross section (mm ²)		1.5	1.5	1.5	2.5	2.5
Maximum Cu cable section (mm ²)		16	16	16	35	35
Tightening torque min/max (N·m)		2/2.2	2/2.2	2/2.2	3.5/3.85	3.5/3.85

(1) A/B: Category with index A = frequent operation; category with index B = infrequent operation.
 (2) The power value is given for information only; the current values vary from one manufacturer to another.
 (3) For a rated operating voltage, $U_s = 400$ Vac.

UL 508 Non-Fused Rotary Disconnect Switches—16 to 80A

Specifications



RD16-3-508









RD16-3-508 with 6-Pole Conversion Kit

Part Number	RD16-3-508	RD25-3-508	RD40-3-508	RD63-3-508	RD80-3-508
UL Standard	UL 508	UL 508	UL 508	UL 508	UL 508
Max Ampacity	16A	25A	40A	63A	80A
Handle Operation	Front/Side	Front/Side	Front/Side	Front/Side	Front/Side
UL Electrical Ratings					
Max Voltage (AC)	600Vac	600Vac	600Vac	600Vac	600Vac
Maximum Horsepower Ratings					
3-Phase, 208Vac	3	7.5	7.5	15	15
3-Phase, 240Vac	5	7.5	7.5	20	20
3-Phase, 480Vac	10	15	20	40	40
3-Phase, 600Vac	10	20	25	40	40
Electrical Characteristics					
SCCR with Fuse	65kA	65kA	10/65kA	50/65kA	50/65kA
Recommended Upstream Fuse Class	J	J	J	J	J
Max. Fuse Rating	30A	30A	60/30A	100/60A	100/60A
Terminals	Integral	Integral	Integral	Integral	Integral
Wire Type	75°C Cu	75°C Cu	75°C Cu	75°C Cu	75°C Cu
Wire Range & Torque - Lb-IN (N·m)					
Solid					
Single	#14-10 26.5 (3)	#14-10 26.5 (3)	#14-10 26.5 (3)	#14-10 31.1 (3.5)	#14-10 31.1 (3.5)
Dual	#12 26.5 (3)	#12 26.5 (3)	#12 26.5 (3)	#12 31.1 (3.5)	#12 31.1 (3.5)
Stranded					
Single	#14-4 26.5 (3)	#14-4 26.5 (3)	#14-4 26.5 (3)	#14-1 31.1 (3.5)	#14-1 31.1 (3.5)
Dual	#14-12 26.5 (3)	#14-12 26.5 (3)	#14-12 26.5 (3)	#10-6 31.1 (3.5)	#10-6 31.1 (3.5)
Mechanical Characteristics					
Endurances/Cycles	10,000	10,000	10,000	10,000	10,000
Physical Characteristics					
Dimensions - See drawings on product pages					
Weight - Lb (KG)	0.5 (0.2)	0.5 (0.2)	0.5 (0.2)	0.7 (0.32)	0.7 (0.32)
Environmental					
Operating Temperature	-20°C to 70°C	-20°C to 70°C	-20°C to 70°C	-20°C to 70°C	-20°C to 70°C
Flammability Rating	UL 94-V0	UL 94-V0	UL 94-V0	UL 94-V0	UL 94-V0
Accessories					
Handles					
Direct	DIR-01	DIR-01	DIR-01	DIR-01	DIR-01
Short Selector/NEMA 1, 3R, 4, 4X, 12	H4X-01B H4X-01R	H4X-01B H4X-01R	H4X-01B H4X-01R	H4X-01B H4X-01R	H4X-01B H4X-01R
Long Selector/NEMA 1, 3R, 4, 4X, 12	H4X-02B H4X-02R	H4X-02B H4X-02R	H4X-02B H4X-02R	H4X-02B H4X-02R	H4X-02B H4X-02R
Shafts - 5x5mm					
5.9"/150mm	SH4-150	SH4-150	SH4-150	SH4-150	SH4-150
7.9"/200mm	SH4-200	SH4-200	SH4-200	SH4-200	SH4-200
12.6"/320mm	SH4-320	SH4-320	SH4-320	SH4-320	SH4-320
Shaft Guide	SH-GUIDE1	SH-GUIDE1	SH-GUIDE1	SH-GUIDE1	SH-GUIDE1
Door Mount Kit	DOOR-508	DOOR-508	DOOR-508	DOOR-508	DOOR-508
Shrouds/Switch Amps					
1-Pole	TSH1-1TB	TSH1-1TB	TSH1-1TB	TSH2-3TB	TSH2-3TB
3-Pole (Loadside and Lineside)	TSH1-3TB	TSH1-3TB	TSH1-3TB	—	—
Switched 4 th Pole/Switch Amps	POLE-16	POLE-25	POLE-40	—	—
Auxiliary Contacts					
NO + NC (1 ea.)	BAC01	BAC01	BAC01	BAC01	BAC01
(2) NO	BAC02	BAC02	BAC02	BAC02	BAC02
AC Ratings					
Volts	240Vac	240Vac	240Vac	240Vac	240Vac
Amps	10A	10A	10A	10A	10A
6-/8-Pole Conversion Kit					
Gangs two switches of same rating, 16-80A switch amps	KIT-6POLE	KIT-6POLE	KIT-6POLE	KIT-6POLE	KIT-6POLE
— Not available.					

Disconnect Switches

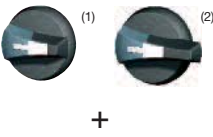
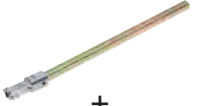
UL 508 Non-Fused Rotary Disconnect Switches—16, 25, 40, 63 and 80A



For a Complete Assembly, Please Select:

SWITCH		Switch										
		Switch Amp Rating	No. of Poles	SCCR @600V	Max Class J Fuse	Max Horsepower Rating, 3-Ph				Wire Size	Wire Type	Part Number
						208 Vac	220/240Vac	440/480Vac	600 Vac			
		16	3	65kA	30A	3	5	10	10	#14-#10 Sol Dual #12 Sol #14-#4 Str Dual #14-#12 Str	75°C Cu	RD16-3-508
		25	3	65kA	30A	7.5	7.5	15	20	#14-#10 Sol Dual #12 Sol #14-#4 Str Dual #14-#12 Str	75°C Cu	RD25-3-508
		40	3	10kA 65kA	60A 30A	7.5	7.5	20	25	#14-#10 Sol Dual #12 Sol #14-#4 Str Dual #14-#12 Str	75°C Cu	RD40-3-508
63	3	50kA 65kA	100A 60A	15	20	40	40	#14-#10 Sol Dual #12 Sol #14-#1 Str Dual #10-#6 Str	75°C Cu	RD63-3-508		
80	3	50kA 65kA	100A 60A	15	20	40	40	#14-#10 Sol Dual #12 Sol #14-#1 Str Dual #10-#6 Str	75°C Cu	RD80-3-508		
+												
Select for Standard Applications		Direct Mount Handle - mounts directly to switch, no shaft required									Part Number	
		For Switch Part Number	Color	Test Function	Padlockable							
		All Switches	Black	N	Y - On Switch						DIR-01	
OR												
HANDLE	   	External Front or Right Side Operated Selector Handles - shaft required									Part Number	
		NEMA Type	Color	Handle Length	Test Function	Padlockable	Defeatable					
		1, 3R, 4, 4X, 12	Black	Short	N	Y	Y				H4X-01B ⁽¹⁾	
		1, 3R, 4, 4X, 12	Red/Yellow	Short	N	Y	Y				H4X-01R ⁽¹⁾	
		1, 3R, 4, 4X, 12	Black	Long	N	Y	Y				H4X-02B ⁽²⁾	
		1, 3R, 4, 4X, 12	Red/Yellow	Long	N	Y	Y				H4X-02R ⁽²⁾	
		Shafts for Selector Handles - required for 12.6" (320mm) shafts									Part Number	
		Length in (mm)	Mounting Depth (X) in (mm)									
		5.9 (150)	3.50-7.60 (89-193)								SH4-150	
		7.9 (200)	3.50-9.50 (89-241)								SH4-200	
12.6 (320)	3.50-14.9 (89-378)								SH4-320			
Shaft Guide									Part Number			
Required for 12.6" (320mm) long shafts, optional for other lengths.									SH-GUIDE1			
Door Mount Kit - for mounting switch on the right side of the enclosure or directly on the enclosure door using switch side operation shaft location. Kit includes a shaft. <i>Order switch and selector handle separately.</i>									Part Number			
All Switches - kit includes shaft									DOOR-508			
and ...												
Acc.		Auxiliary Contacts										
		Contact Type	Number of Contacts	Continuous Amp Rating	Voltage Rating	Max Number of Aux Contacts per Switch	Part Number					
		NO + NC	1 Ea	10A	240Vac	4	BAC01					
		NO	2	10A	240Vac	4	BAC02					



Auxiliary Contact Configurations

UL 508 Non-Fused Rotary Disconnect Switches—16, 25, 40, 63 and 80A

		and ...		
SHROUDS		Terminal Shrouds - includes terminal shroud for both lineside <i>and</i> loadside		
		Switch Amp Rating	Number of Poles	Location on Switch
		16-40A	1 (for switched 4 th pole)	Lineside and Loadside
		16-40A	3	Lineside and Loadside
		63-80A	3	Lineside and Loadside
		and ...		
Accessories	SW. 4 TH POLE 	Switched 4th Pole - converts 3-pole switch to 4-pole switch		
		Switch Amp Rating		Part Number
		16		POLE-16
		25		POLE-25
		40		POLE-40
		and ...		
6-POLE KIT		6-Pole Conversion Kit - creates a 6-pole switch by ganging two 3-pole switches of equal rating		
		Switch Amp Rating		Part Number
		All Switches		KIT-6POLE*
Order switches separately.		* Kit ships with a direct handle. If external handle is needed order a selector handle <i>and</i> shaft for the UL 508 Rotary Disconnect Switches. Note: To create an 8-pole switch from 16 to 40 amp switches, use two 3-pole switches of equal ratings plus two switched 4 th poles (part # POLE-).		

Disconnect Switches

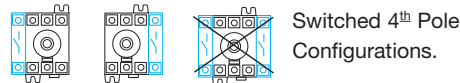

Dimensions – in (mm)

Direct Handle Operation

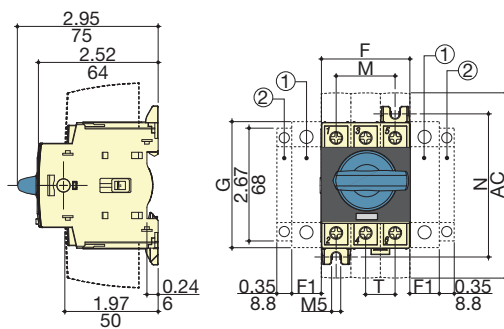

1. Position for 1 switched 4th pole (1 per device max.) or 1 auxiliary contact.
 2. Position for 1 auxiliary contact only.
- Note: Maximum of 4 auxiliary contacts, or 3 auxiliary contacts + one switched 4th pole.

External Front Operation

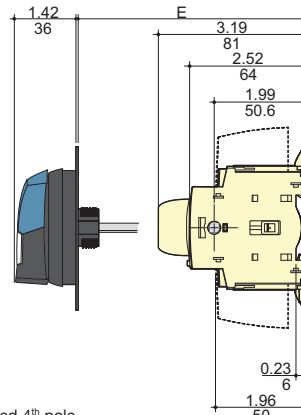

External Side Operation

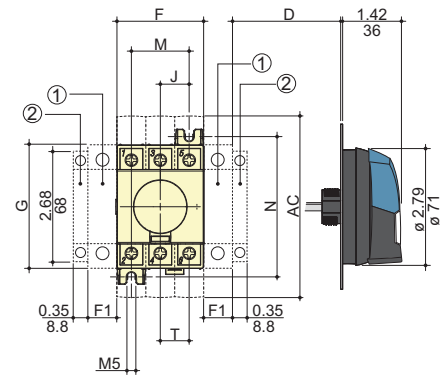

Switch Rating (A)	Overall Dimensions				Terminal Shroud AC	Switch Body				Switch Mounting		Connection T
	D min	D max	E min	E max		F	F1	G	J	M	N	
16 to 40	1.18 (30)	9.25 (235)	3.94 (100)	14.64 (372)	4.33 (110)	1.77 (45)	0.59 (15)	2.67 (68)	0.59 (15)	1.18 (30)	2.95 (75)	0.59 (15)
63 to 80	1.18 (30)	9.25 (235)	3.93 (100)	14.64 (372)	4.33 (110)	2.06 (52.5)	0.69 (17.5)	2.99 (76)	0.69 (17.5)	1.38 (35)	3.35 (85)	0.69 (17.5)

UL 508 Non-Fused Rotary Disconnect Switches—16, 25, 40, 63 and 80A

Dimensions – in (mm)

Direct Front Operation for 6/8-Pole Disconnects

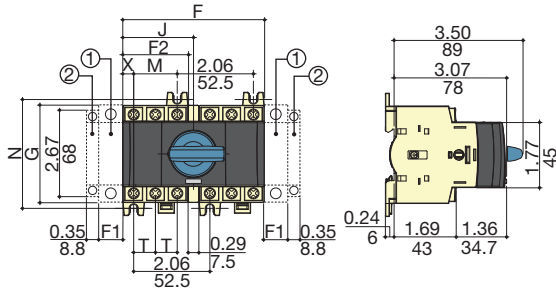

External Front Operation for 6/8-Pole Disconnects

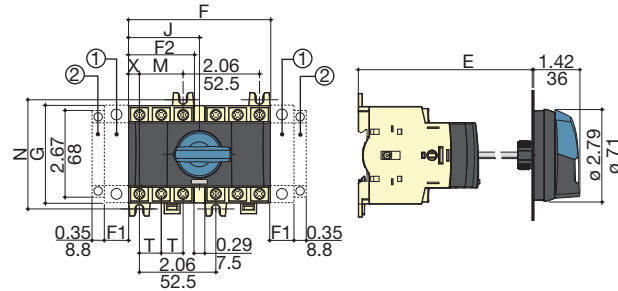

- 1. Position for 1 switched 4th pole (1 per device max.) or 1 auxiliary contact.
 - 2. Position for 1 auxiliary contact only.
- Note: Maximum of 4 auxiliary contacts, or 3 auxiliary contacts + one switched 4th pole.

Switch Rating (A)	Overall Dimensions			Switch Body				Switch Mounting		Connection	
	E min	E max	F	F1	F2	G	J	M	N	T	X
16 to 40	4.13 (105)	14.64 (372)	3.83 (97.5)	0.59 (15)	1.77 (45)	2.67 (68)	1.92 (48.75)	1.18 (30)	2.95 (75)	0.59 (15)	0.29 (7.5)
63 to 80	4.13 (105)	14.65 (372)	4.13 (105)	0.69 (17.5)	2.06 (52.5)	2.99 (76)	2.06 (52.5)	1.38 (35)	3.35 (85)	0.69 (17.5)	0.34 (8.75)

External Selector Handles

Handle Type

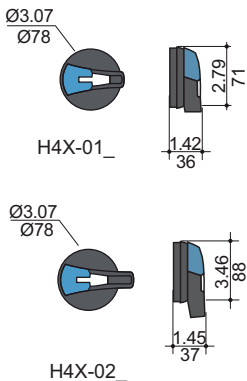

Direction of Front Operation

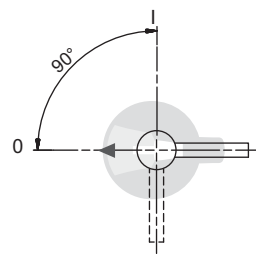

Direction of Right Side Operation

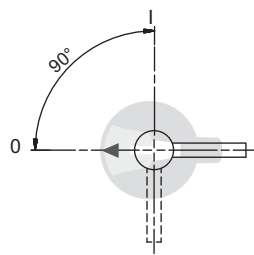

Door Drilling Layouts

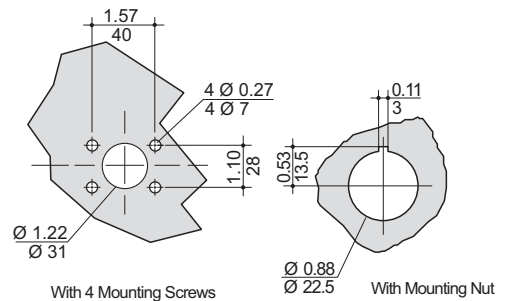

UL 98 & UL 508 Enclosed Disconnect Switches

Description

Fused and non-fused enclosed Rotary Disconnect Switches from 16 to 1200A in NEMA 1, 3R, 4, 4X, 12 enclosures.

Features

- UL 98 Listed for general purpose, main disconnect, or branch circuit protection up to 600Vac/dc
- UL 508 Listed for motor disconnect applications up to 600Vac
- Multiple field installed accessories enhance the enclosed disconnect switches to fit the desired application
- Lockout/tagout: Up to three 1/4" shank padlocks can be installed on external handles

Ratings:

- Volts: 600Vac
250-600Vdc*
- Amps: 16-1200A
- Short-Circuit Current Ratings: UL 98: 25kA-200kA
UL 508: 10kA-65kA

*Some non-fused disconnect switches are not rated for DC applications.

Specifications

- Operating temperature: -20°C to 70°C
- 4X Plastic Enclosure Flammability Rating:
Polycarbonate UL 94-5VA-0
Fiberglass UL 94-5V

Agency Information

- UL 98 Listed: File E182262, Guide WIAX, WIAX7
- UL 508 Listed: File E155129, Guide NLRV, NLRV7
- cULus Listed to CSA Standard 22.2, No. 14
- cULus Listed to CSA Standard 22.2, No. 4
- Conforms with IEC 60947-3
- CE Compliant
- RoHS Compliant

Field Installed Accessories

- Auxiliary contacts
- Terminal shrouds

Online Resources

Visit www.cooperbussmann.com/Disconnects for:

- CAD Drawings
- Instruction Sheets
- UL Information



NEMA 1, 3R, 4 & 12



NEMA 4X
Stainless Steel



NEMA 4X
Polycarbonate
or Fiberglass

QuikShip 
Everyday

QuikShip Everyday Service ships the most common part numbers within 24 hours. Contact your Bussmann representative for details.

Disconnect
Switches

Available Bussmann Fuses

Class	Type	Data Sheet #
CC	LP-CC Time-Delay, Current Limiting	1023
CC	FNQ-R Time-Delay	1014
CC	KTK-R Fast-Acting	1015
J	LPJ Time-Delay, Current Limiting	1006 (0-60A)
J		1007 (70-600A)
J	With easyID™ open fuse indication	1062 (6-60A)
J		1063 (70-600A)
J	JKS Fast-Acting Fuses	1026 (0-60A)
J		1027 (70-600A)
J	DFJ High Speed Drive Fuse	1048 (0-600A)
L	KRP-C Time-Delay, Current Limiting	1008
L	KTU Fast-Acting	1010
L	KLU Time-Delay	1013

UL 98 Enclosed Fused Disconnects—30 to 800A

3-Pole UL 98 600Vac

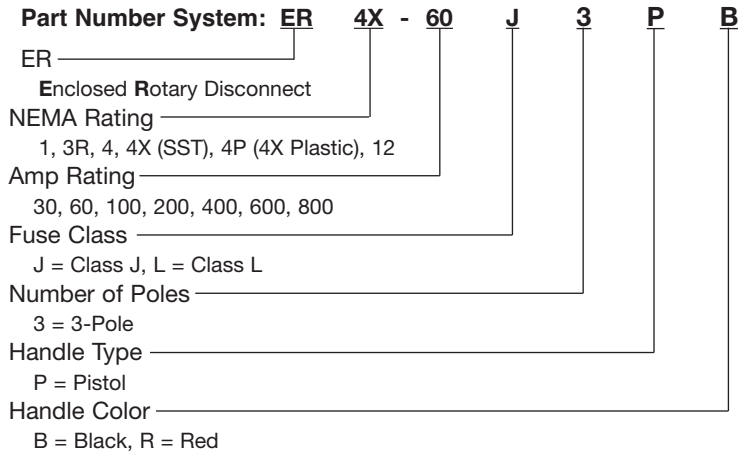

Part Numbers - All part numbers provided with integral or installed lugs and a black selector handle. Order red/yellow handle by changing the suffix “B” to “R.”

UL General Purpose Amp Rating	Fuse Type	NEMA Enclosure Type & Part Number					
		1	3R	4	4X Plastic ⁽¹⁾	4X Stainless	12
30	J	ER1-30J3PB	ER3R-30J3PB	ER4-30J3PB	ER4P-30J3PB	ER4X-30J3PB	ER12-30J3PB
60	J	ER1-60J3PB	ER3R-60J3PB	ER4-60J3PB	ER4P-60J3PB	ER4X-60J3PB	ER12-60J3PB
100	J	ER1-100J3PB	ER3R-100J3PB	ER4-100J3PB	ER4P-100J3PB	ER4X-100J3PB	ER12-100J3PB
200	J	ER1-200J3PB	ER3R-200J3PB	ER4-200J3PB	ER4P-200J3PB	ER4X-200J3PB	ER12-200J3PB
400	J	ER1-400J3PB	ER3R-400J3PB	ER4-400J3PB	ER4P-400J3PB	ER4X-400J3PB	ER12-400J3PB
600	J	ER1-600J3PB	ER3R-600J3PB	ER4-600J3PB	ER4P-600J3PB	ER4X-600J3PB	ER12-600J3PB
800	L	ER1-800L3PB	ER3R-800L3PB	ER4-800L3PB	ER4P-800L3PB	ER4X-800L3PB	ER12-800L3PB

(1) Enclosures ≤100A are polycarbonate, flammability rating UL 94-5VA-V0, ≥200A are fiberglass, flammability rating UL 94-5V.

Switch Ratings - for wire types, ranges and tightening torques, see table on page 387

Switch Amp Rating	Disconnect Switch	Fuse Type	No. of Poles	Voltage		SCCR @ Vac	Max Hp Rating @ 600Vac
				Vac	Vdc		
30	RDF30J-3	J	3	600	250	200kA	20
60	RDF60J-3	J					50
100	RDF100J-3	J					75
200	RDF200J-3	J					150
400	RDF400J-3	J					350
600	RDF600J-3	J		600	500		
800	RDF800L-3	L					

UL 98 Enclosed Fused Disconnects—30 to 800A

Enclosure Weights - Lbs & Dimensions - in

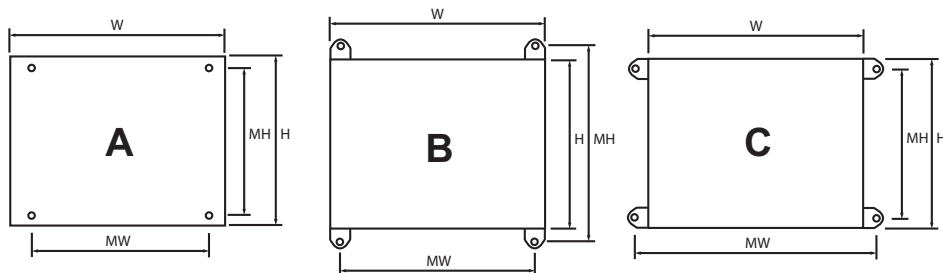



Part Number Family	Amp Rating	Fuse Type	NEMA Enclosure Type	H x W x D	Mounting Centers H x W			Weight Lbs
					A	B	C	
ER_-30J	30	J	1, 3R, 4, 12	10x10x6	8.3x8.3			15
			4X-SST	10x10x6		9.5x8.3	8.3x9.5	15
			4X-Plastic ⁽¹⁾	12x10x6		12x5.6	7.64x10	8
ER_-60J	60	J	1, 3R, 4, 12	12x10x6	10.3x8.3			19
			4X-SST	12x10x6		11.5x8.3	10.3x9.5	19
			4X-Plastic ⁽¹⁾	13x13x6		14x7.6	9.6x12	11
ER_-100J	100	J	1, 3R, 4, 12	14x12x6	12.3x10.3			21
			4X-SST	14x12x6		13.5x10.3	12.3x11.5	21
			4X-Plastic ⁽¹⁾	13x13x6		14x7.6	9.6x12	12
ER_-200J	200	J	1, 3R, 4, 12	24x20x8	22x18.1			55
			4X-SST	24x20x8		23.2x18.1	22x19.3	55
			4X-Plastic ⁽¹⁾	27x21x10		25.75x14		39
ER_-400J	400	J	1, 3R, 4, 12	48x36x12	45.75x34.9			188
			4X-SST	48x36x12		46.9x34.9	45.75x36.1	188
			4X-Plastic ⁽¹⁾	51x37x14		50.1x28.5		186
ER_-600J	600	J	1, 3R, 4, 12	48x36x12	45.75x34.9			216
			4X-SST	48x36x12		46.9x34.9	45.75x36.1	216
			4X-Plastic ⁽¹⁾	51x37x14		50.1x28.5		214
ER_-800L	800	L	1, 3R, 4, 12	48x36x12	45.75x34.9			216
			4X-SST	48x36x12		46.9x34.9	45.75x36.1	216
			4X-Plastic ⁽¹⁾	51x37x14		50.1x28.5		214

(1) Enclosures ≤100A are polycarbonate, flammability rating UL 94-5VA-V0, ≥200A are fiberglass, flammability rating UL 94-5V.

Disconnect Switches

Available Field-Installed Accessories - Order Separately

	Auxiliary Contacts - for 30 to 800 Amp Switches					
	Contact Type	Number of Contacts	Continuous Amp Rating	Voltage Rating	Max Number of Aux Contacts per Switch	Part Number
	NO	1	10A	600Vac	30 to 200A: 4 400 to 800A: 8	BAC05
	NC	1	10A	600Vac		BAC06

	Terminal Shrouds - for 200 to 800 Amp Switches - includes terminal shroud for lineside or loadside			
	Switch Amp Rating	Number of Poles		Part Number
	200	3		TSH8-3TB
	400	3		TSH9-3TB
	600-800	3		TSH10-3TB

UL 98 Enclosed Non-Fused Disconnects—30 to 1200A

3-Pole UL 98 600Vac

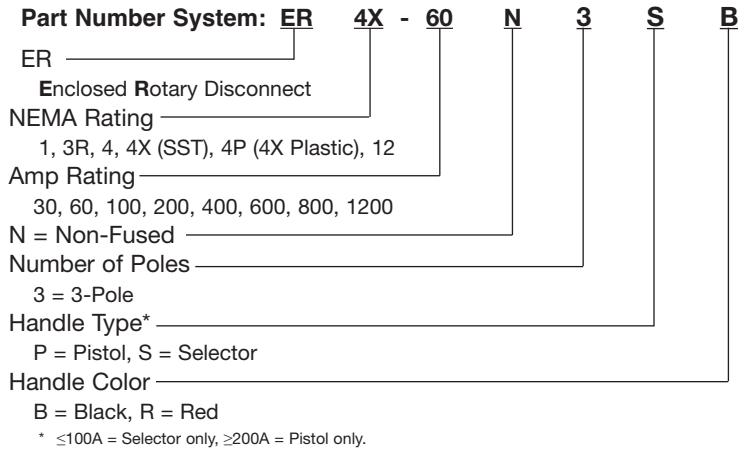

Part Numbers - All part numbers provided with integral or installed lugs and a black selector handle. Order red/yellow handle by changing the suffix "B" to "R."

UL General Purpose Amp Rating	NEMA Enclosure Type & Part Number					
	1	3R	4	4X Plastic ⁽¹⁾	4X Stainless	12
30	ER1-30N3SB	ER3R-30N3SB	ER4-30N3SB	ER4P-30N3SB	ER4X-30N3SB	ER12-30N3SB
60	ER1-60N3SB	ER3R-60N3SB	ER4-60N3SB	ER4P-60N3SB	ER4X-60N3SB	ER12-60N3SB
100	ER1-100N3SB	ER3R-100N3SB	ER4-100N3SB	ER4P-100N3SB	ER4X-100N3SB	ER12-100N3SB
200	ER1-200N3PB	ER3R-200N3PB	ER4-200N3PB	ER4P-200N3PB	ER4X-200N3PB	ER12-200N3PB
400	ER1-400N3PB	ER3R-400N3PB	ER4-400N3PB	ER4P-400N3PB	ER4X-400N3PB	ER12-400N3PB
600	ER1-600N3PB	ER3R-600N3PB	ER4-600N3PB	ER4P-600N3PB	ER4X-600N3PB	ER12-600N3PB
800	ER1-800N3PB	ER3R-800N3PB	ER4-800N3PB	ER4P-800N3PB	ER4X-800N3PB	ER12-800N3PB
1200	ER1-1200N3PB	ER3R-1200N3PB	ER4-1200N3PB	N/A	ER4X-1200N3PB	ER12-1200N3PB

(1) Enclosures ≤100A are polycarbonate, flammability rating UL 94-5VA-V0, ≥200A are fiberglass, flammability rating UL 94-5V.

Switch Ratings - for wire types, ranges and tightening torques, see table on page 405

Switch Amp Rating	Disconnect Switch	No. of Poles	Voltage		SCCR @ Vac	Max Hp Rating @ 600Vac
			Vac	Vdc		
30	RD30-3	3	600	250	100kA	25
60	RD60-3					
100	RD100-3					
200	RD200-3					
400	RD400-3					
600	RD600-3					
800	RD800-3				N/A	100kA
1200	RD1200-3					

* 25kA @ 600Vac, 100kA @ 480Vac.

UL 98 Enclosed Non-Fused Disconnects—30 to 1200A

Enclosure Weights - Lbs & Dimensions - in

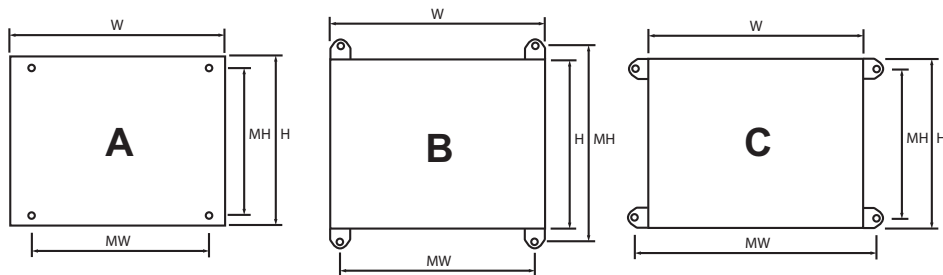

Part Number Family	Amp Rating	NEMA Enclosure Type	H x W x D	Mounting Centers H x W			Weight Lbs
				A	B	C	
ER_-30	30	1, 3R, 4, 12	10x8x6	8.3x6.3			11
		4X-SST	10x8x6		9.5x6.3	8.3x7.5	11
		4X-Plastic ⁽¹⁾	9x9x6		10x3.6	5.6x8	5
ER_-60	60	1, 3R, 4, 12	10x8x6	8.3x6.3			12
		4X-SST	10x8x6		9.5x6.3	8.3x7.5	12
		4X-Plastic ⁽¹⁾	9x9x6		10x3.6	5.6x8	5
ER_-100	100	1, 3R, 4, 12	12x10x6	10.3x8.3			12
		4X-SST	12x10x6		11.5x8.3	0.3x9.5	12
		4X-Plastic ⁽¹⁾	13x13x6		14x7.6	9.6x12	8
ER_-200	200	1, 3R, 4, 12	20x16x8	18.1x14.2			39
		4X-SST	20x16x8		19.3x14.2	18.1x15.4	39
		4X-Plastic ⁽¹⁾	23x17x12		21.5x10.1		31
ER_-400	400	1, 3R, 4, 12	36x30x8	33.9x28.3			122
		4X-SST	36x30x8		35.1x28.3	33.9x29.5	122
		4X-Plastic ⁽¹⁾	40x32x14		38.1x23.9		103
ER_-600	600	1, 3R, 4, 12	48x36x12	45.8x34.9			209
		4X-SST	48x36x12		47x34.9	45.8x36.1	209
		4X-Plastic ⁽¹⁾	51x37x 14		50.1x28.5		187
ER_-800	800	1, 3R, 4, 12	48x36x12	45.8x34.9			211
		4X-SST	48x36x12		47x34.9	45.8x36.1	211
		4X-Plastic ⁽¹⁾	51x37x 14		50.1x28.5		189
ER_-1200	1200	1, 3R, 4, 12	60x36x16	57.5x33.9			268
		4X-SST	60x36x16		58.7x33.9	57.5x35.1	268

(1) Enclosures ≤100A are polycarbonate, flammability rating UL 94-5VA-V0, ≥200A are fiberglass, flammability rating UL 94-5V.

Available Field-Installed Accessories - Order Separately

Switch Amp Rating	Auxiliary Contacts - for 30 to 1200 Amp Switches						
	Contact Type	Number of Contacts	Continuous Amp Rating	Voltage Rating	Max Number of Aux Contacts per Switch	Part Number	
30-100	NO + NC	1 of each	10A	240Vac	4	BAC01	
30-100	NC	2	10A	240Vac	4	BAC02	
100-1200	NO + NC	1 of each	10.1A	125-250Vac	2	BAC03*	
100-1200	NO + NC	1 of each	10.1A	125-250Vac	2	BAC04*	
100-1200	NO + NC	1 of each	1A	125Vac	2	BAC11*	
100-1200	NO + NC	1 of each	1A	125Vac	2	BAC12*	

* For one auxiliary contact, install either BAC03 or BAC11. For two auxiliary contacts, install BAC03 + BAC04, or BAC11 + BAC12.

Switch Amp Rating	Terminal Shrouds - for 200 to 800 Amp Switches			
	Number of Poles	Location on Switch	Part Number	
30-100	3	Lineside and Loadside	TSH3-3TB	
200A	3	Lineside	TSH4-3T	
200A	3	Loadside	TSH4-3B	
400A	3	Lineside	TSH5-3T	
400A	3	Loadside	TSH5-3B	
600A	3	Lineside or Loadside	TSH6-3TB	
800-1200A	3	Lineside or Loadside	TSH7-3TB	

Disconnect Switches

UL 508 Enclosed Non-Fused Disconnects—16 to 80A

3-/6-Pole UL 508 600Vac

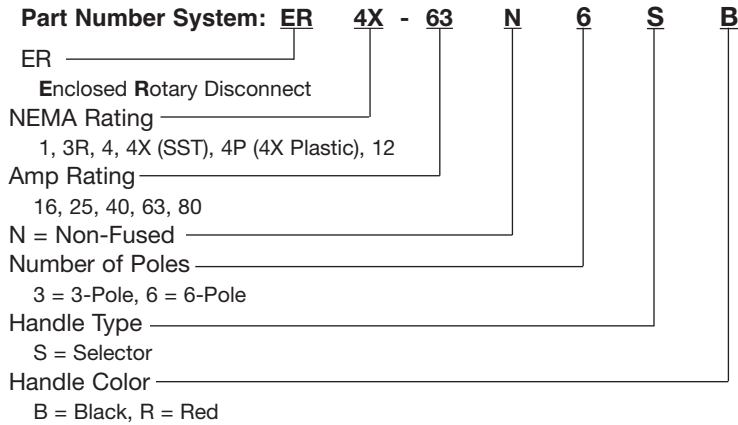

Part Numbers - All part numbers provided with a black selector handle. Order red/yellow handle by changing the suffix "B" to "R."

UL General Purpose Amp Rating	No. of Poles	NEMA Enclosure Type & Part Number					
		1	3R	4	4X Plastic ⁽¹⁾	4X Stainless	12
16	3	ER1-16N3SB	ER3R-16N3SB	ER4-16N3SB	ER4P-16N3SB	ER4X-16N3SB	ER12-16N3SB
	6	ER1-16N6SB	ER3R-16N6SB	ER4-16N6SB	ER4P-16N6SB	ER4X-16N6SB	ER12-16N6SB
25	3	ER1-25N3SB	ER3R-25N3SB	ER4-25N3SB	ER4P-25N3SB	ER4X-25N3SB	ER12-25N3SB
	6	ER1-25N6SB	ER3R-25N6SB	ER4-25N6SB	ER4P-25N6SB	ER4X-25N6SB	ER12-25N6SB
40	3	ER1-40N3SB	ER3R-40N3SB	ER4-40N3SB	ER4P-40N3SB	ER4X-40N3SB	ER12-40N3SB
	6	ER1-40N6SB	ER3R-40N6SB	ER4-40N6SB	ER4P-40N6SB	ER4X-40N6SB	ER12-40N6SB
63	3	ER1-63N3SB	ER3R-63N3SB	ER4-63N3SB	ER4P-63N3SB	ER4X-63N3SB	ER12-63N3SB
	6	ER1-63N6SB	ER3R-63N6SB	ER4-63N6SB	ER4P-63N6SB	ER4X-63N6SB	ER12-63N6SB
80	3	ER1-80N3SB	ER3R-80N3SB	ER4-80N3SB	ER4P-80N3SB	ER4X-80N3SB	ER12-80N3SB
	6	ER1-80N6SB	ER3R-80N6SB	ER4-80N6SB	ER4P-80N6SB	ER4X-80N6SB	ER12-80N6SB

(1) Polycarbonate enclosure flammability rating UL 94-5VA-V0.

Switch Ratings - for wire types, ranges and tightening torques, see table on page 413

Switch Amp Rating	Disconnect Switch	Voltage		SCCR with Max Upstream Class J Fuse	Max Hp Rating @ 600Vac
		Vac	Vdc		
16	RD16-3-508	600	N/A	65kA / 30A	10
25	RD25-3-508			65kA / 30A	20
40	RD40-3-508			65kA / 30A — 10kA / 60A	25
63	RD63-3-508			65kA / 60A — 50kA / 100A	40
80	RD80-3-508			65kA / 60A — 50kA / 100A	40

Note: Voltage, SCCR and Horsepower ratings are the same for 3- and 6-pole UL 508 non-fused disconnect switches.

UL 508 Enclosed Non-Fused Disconnects—16 to 80A

Enclosure Weights - Lbs & Dimensions - in

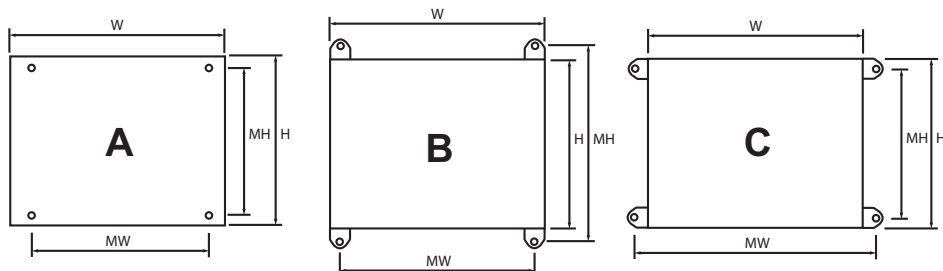

NEMA Enclosure Type	No. of Poles	Switch Amp Ratings	H x W x D	Mounting Centers H x W			Weight Lbs
				A	B	C	
1, 3R, 4, 12	3	16-80A	8x6x6	6.3x4.3			8
	6	16-80A	10x8x6	8.3x6.3			11
4X-SST	3	16-80A	8x6x6		7.5x4.3	6.3x5.5	8
	6	16-80A	10x8x6		9.5x6.3	8.3x7.5	11
4X-Plastic ⁽¹⁾	3	16-63A	7.4x8.7x5.8	8x3.6	3.6x8		4
		80A	9.4x8.7x5.9	10x3.6	5.6x8		5
	6	16-80A	11.4x10.7x6.3	12x5.6	7.64x10		6

(1) Polycarbonate.

Disconnect Switches

Available Field-Installed Accessories - Order Separately

	Auxiliary Contacts					
	Contact Type	Number of Contacts	Continuous Amp Rating	Voltage Rating	Max Number of Aux Contacts per Switch	Part Number
	NO + NC	1 Ea	10A	240Vac	4	BAC01
NO	2	10A	240Vac	4	BAC02	

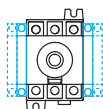

Auxiliary Contact Configurations

	Terminal Shrouds - includes terminal shroud for both lineside <i>and</i> loadside				
	Switch Amp Rating	Number of Poles		Location on Switch	Part Number
	16-40A	3		Lineside and Loadside	TSH1-3TB
63-80A	3		Lineside and Loadside	TSH2-3TB	

	Switched 4 th Pole - converts 3-pole switch to 4-pole switch	
	Switch Amp Rating	Part Number
	16	POLE-16
	25	POLE-25
40	POLE-40	

Fused, Dead Front Disconnect Switches

15149 Series

Specifications

Description: Fused, dead front disconnect switches

Ratings:

Volts: — 600Vac

Amps: — 0-30A

SCCR: — 200kA RMS Sym.

Dielectric SCCR: 2200V

Motor Rating: 5Hp

Poles: 2 to 3

Agency Information: UL Recognized, file E120756 for General Industrial installations. Guide WGEU2. CSA certified, file LR37129-6. Examined under the new proposed standard UL 1429 which imparts a stricter set of test conditions than the former program that combined the applicable portions for UL 512 (Fuse Holders) and UL 98 (Enclosed Switches).



Features and Benefits

- Fuse holders in the pull-out head eliminate possibility of electric shock while changing fuse.
- Accepts Class J fuses

Ordering Information

To order, specify: 15149 + number of poles.

Example: 15149-2 = 2-pole device.



Flexibility and Convenience Make Point-of-Use Configuration Easy



Full range of open disconnect switches with versatile options and accessories that ship within 24 hours

www.cooperbussmann.com

Telecom Protection Products

Section Contents Page

Telpower compact fused disconnect switches	426
Telpower miniature fused disconnect switches	427
Fused disconnect switches for TPA fuses	
TP15914 4-Pole disconnect switch	428
TP11590-4 4-Pole disconnect switch	429
TPA & TPA-B Fuses	429
Fused disconnect switches for TPS fuses	
15800 1-Pole fused disconnect switch	430
TPS Fuses	430
Fused disconnect switches	
TP158HC panel mount, rear access switch	431
15100 1-Pole switch for use with TPL fuses	432
TPHCS Telpower high-current switch	433
TPL Telpower 70-600A: 170Vdc fuses	434
TPN Telpower 1-600A: 170Vdc fuses	435
70 Series Indicating fuses	436
15087 Fuse holders	436
HLS, HLT & PCT fuse holders	437
GMT Fast acting fuses	437
GMT-A Fast acting fuse	437
Telpower specialty fuses	
7 Type Fuses	438
11 Type Fuse	438
24 & WER Type non-indicating, visible link fuses	438
74 Type Fast acting fuses	438
75 Type Cylindrical fuses with leads	439
76 Type Cylindrical fuses with leads	439
80 Type visual indicating fuses	439



Scan this tag to get the latest product information for Telecom Protection Products.

Telepower Compact Fused Disconnect Switches

TPC & TPCDS

Specifications Descriptions:

— **TPC:** Telepower compact current-limiting fuses.

— **TPCDS:** Telepower compact fused disconnect switch available in two disconnect switch profiles in addition to a variety of terminal styles. Recommended 0.75" center-to-center product spacing.

Dimensions: See Data Sheet 5023.

Ratings:

Volts: — 80Vdc
 Amps: — 3-125A (See Catalog Numbers table for details)
 IR: — 100kA

Agency Information: CE, UL Recognized (investigated to UL 1801) as a disconnect switch for the interruption of load current by means of withdrawing the fuse pullout. Recognized to US and Canadian requirements under the component recognition program of Underwriters Laboratories Inc. Files E219046 and E56412.

Flammability Ratings: Fuse UL 94V0, 170°C RTI, Housing UL 94V0, 120°C RTI.

Features and Benefits

- Highest interrupting rating (100kA) available and complete system coordination for DC circuit protection for compact footprint providing a superior protection solution for replacement of existing DC telecom circuit breakers
- AmpColor ID™ System makes fuse replacement easy
- Local and remote open fuse indication. Local alarm indication provided by LED on TPC fuse
- Remote alarm terminal available in three positions common to DC circuit protection devices

Typical Applications

- Telecommunications DC power circuit protection
- Replacement of DC telecom circuit breakers
- Applications where venting of arc or molten metals and gases during opening would pose a problem to surrounding devices



Catalog Numbers

TPCS disconnect switch		TPC Current-Limiting Fuse	
Catalog Numbers	Amp Range	Catalog Numbers	Amp Rating
TPCDS-BBE-1	3-125	TPC-3	3
TPCDS-BBE-2	3-125	TPC-4	4
TPCDS-BBE-3	3-125	TPC-5	5
TPCDS-BBM-1	3-125	TPC-6	6
TPCDS-BBM-2	3-125	TPC-7	7
TPCDS-BBM-3	3-125	TPC-8	8
TPCDS-BSE-1	3-125	TPC-10	10
TPCDS-BSE-2	3-125	TPC-12	12
TPCDS-BSE-3	3-125	TPC-15	15
TPCDS-BSM-1	3-125	TPC-20	20
TPCDS-BSM-2	3-125	TPC-25	25
TPCDS-BSM-3	3-125	TPC-30	30
TPCDS-SSE-1	3-125	TPC-40	40
TPCDS-SSE-2	3-125	TPC-50	50
TPCDS-SSE-3	3-125	TPC-60	60
TPCDS-SSM-1	3-125	TPC-75	75
TPCDS-SSM-2	3-125	TPC-90	90
TPCDS-SSM-3	3-125	TPC-100	100
TPCDS-D-BC1*	3-125	TPC-125	125
TPCDS-D-BC2*	3-125		
TPCDS-D-CC1*	3-125		
TPCDS-D-SEC1*	3-125		
TPCDS-D-SEC2*	3-125		
TPCDS-D-SMC1*	3-125		
TPCDS-D-SMC2*	3-125		

*Not investigated to Canadian Requirements.

Telepower Miniature Fused Disconnect Switches

TPM & TPMDs

Specifications Description:

— TPM:

Telepower miniature current-limiting fuses.

— TPMDs:

Telepower miniature fused disconnect switch.



Dimensions: See Data Sheet 5022.

Ratings:

- Volts: — 80Vdc
- Amps: — 3-30A
- IR: — 20kA

Agency Information: CE, UL Recognized (investigated to UL 1801) as a disconnect switch for the interruption of load current by means of withdrawing the fuse pullout. Recognized to US and Canadian requirements under the component recognition program of Underwriters Laboratories Inc. Files E219046 and E56412.

Flammability Ratings: Fuse UL 94V0, 170°C RTI; Switch UL 94V0, 140°C RTI.

Features and Benefits

- Smallest and most versatile fused disconnect switch available allowing for assembly into 1 U (1.75"/44.5mm) panel. Easy to connect; Load: 1/4" quick-connect or bolted connection with 10-32 (M5) captive nut, Line: 1/4" quick-connect or screw connection with clearance hole for #10 (M5) bolt.
- AmpColor ID™ System makes fuse replacement easy
- Switch design provides for easy panel mounting by single captive 4-40 (M3) nut and panel notch integral to switch footprint.
- Complete system coordination capability with local and remote open fuse indication. Local alarm indication provided by LED on TPM fuse (maximum alarm circuit current: 20mA)

Typical Applications

- Telecommunications DC power circuit protection
- Applications with restricted space, or mounting in 1 U panels

Catalog Numbers

Catalog Numbers	Description	Amp Rating
TPM-3	Fuse	3
TPM-4	Fuse	4
TPM-5	Fuse	5
TPM-6	Fuse	6
TPM-7	Fuse	7
TPM-8	Fuse	8
TPM-10	Fuse	10
TPM-12	Fuse	12
TPM-15	Fuse	15
TPM-20	Fuse	20
TPM-25	Fuse	25
TPM-30	Fuse	30
TPMDS-E	Disconnect, English hardware	3-30
TPMDS-M	Disconnect, Metric hardware	3-30

TPM Alarm Schematic

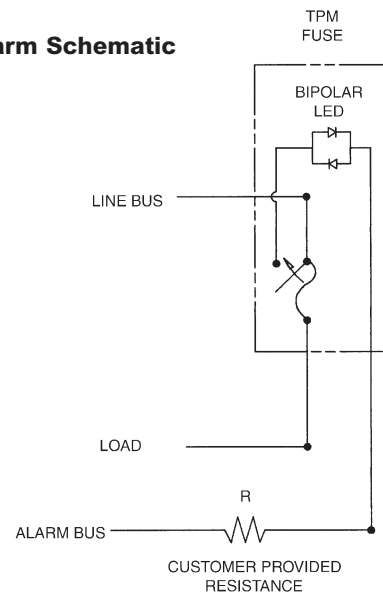

NOTES:

1. The resistance, R, must be provided by the end-user to limit the alarm output current to a maximum of 20mA. The value, R, should be calculated using the system voltage value.
 - If remote alarm functionality is not required, the END-USER CIRCUITRY must still be supplied to provide a resistive path to the return for the local alarm to properly function.
2. The fuse is polarized to maintain proper orientation with the switch housing. The line and load terminals are identified on the switch housing.

Fused Disconnect Switches for TPA Fuses

TP15914

Specifications

Description:

Modular 4-pole disconnect switch for TPA Series fuses — 4-poles per module up to four modules ganged together. Features open fuse indication and fuse presence indication along with fuse orientation rejection feature.

Dimensions: See Dimensions illustrations.

Ratings:

Volts: — 145Vdc
Amps: — 50A per pole

Agency Information: CE, UL Recognized as a disconnect switch for interruption of load current by means of withdrawing the fuse carrier. UL Recognized as a component for telecommunication power distribution equipment (UL category QPQYZ), UL Recognized fuses for branch circuit protection, CSA component acceptance for the system. UL Recognized, Guide JFHR2, File E56412., CSA Certified, Class 1422-30, File 53787.

Flammability Rating: UL 94V0, 140°C.

Features and Benefits

- Totally enclosed module directly connects to busbar for reduced external wiring—per pole and easy installation with front access load and line connection standard—double lug load connections 8 AWG wire
- LED alarm signaling (LED current 30mA max)
- Remote alarm with alarm test probe point to allow on-site checking of alarm circuitry
- Bi-polar LED provides capability for both -48Vdc and +24Vdc applications

Typical Applications

- Telecommunications DC power circuit protection

Catalog Numbers

Catalog Numbers	Hardware
TP15914	English
TP15914-1	Metric



Dimensions mm - (in)

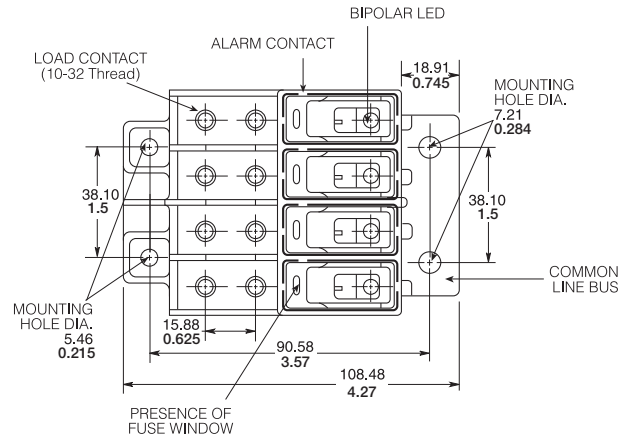

TOP

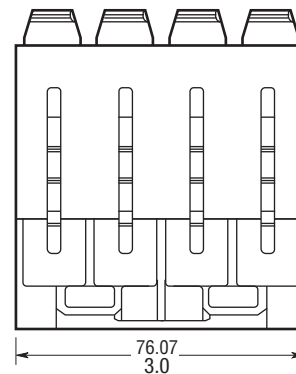

Accessories

- Spare fuse holders: Catalog Numbers 5TPH and TPSFH-A

Fused Disconnect Switches for TPA Fuses

TP15900-4

Specifications

Description: 4-pole disconnect switch for use with Telepower fuses Type TPA & TPA-B.

Dimensions: See Dimensions illustrations.

Ratings:

- Volts: — 145Vdc (40A)
- 80Vdc (50A)
- Amps: — 40A@145Vdc
- 50A@80Vdc

Agency Information: CE, UL Recognized File E97649 as a disconnect switch for interruption of load current by means of withdrawing the fuse carrier. UL Recognized as a component for telecommunication power distribution equipment (UL category QPQY2). UL Recognized fuses for branch circuit protection. CSA Component Acceptance for the system.

Flammability Rating: UL 94V0, 140°C.

Features and Benefits

- Ease of installation - connection directly to busbar, reduces external wiring per pole. Rear accessibility for line and load terminations
- LED alarm signaling (LED current 30mA max)
- Local and remote open-fuse indication along with fuse orientation rejection feature and fuse presence indication
- Alarm test probe point, to allow on-site checking of alarm circuitry

Typical Applications

- Telecommunications DC power circuit protection

Catalog Numbers

Catalog Numbers	Description
TP15900-4	4-Pole common disconnect switch
TP15900-41	4-Pole common disconnect switch w/ Split Alarm, Split Line

Dimensions - mm (in)

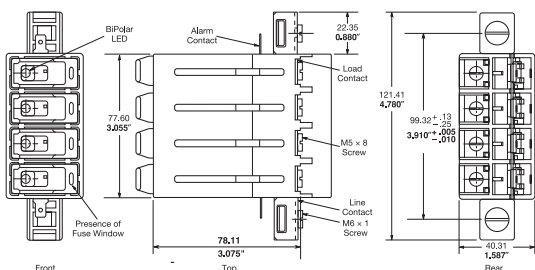

Accessories

- Spare fuse holders: Catalog Numbers 5TPH and TPSFH-AS.

Data Sheet: 5001

TPA & TPA-B

Specifications

Description: DC power distribution indicating fuses.

Dimensions: See Dimensions illustration.

Ratings:

- Volts: — 170Vdc TPA
- 65Vdc TPA-B
- Amps: — 3-50A TPA
- 20-30A TPA-B
- IR: — 100kA TPA
- 20kA TPA-B

Agency Information: CE, UL Recognized, Guide JFHR2, File E56412, CSA Certified, Class 1422-30, File 53787.

Features and Benefits

- Indication pin provides for local and remote indication when used with Bussmann TP15900-4 and TP15914 disconnect switches
- Patented “orange ring” fuse orientation features assures correct fuse position
- The UL Recognized ratings and current-limiting capability make this fuse ideal for cable protection on existing DC power distribution systems
- A unique blue label is used on all Telepower fuses to designate their DC capability

Typical Applications

- Telecommunications DC power circuit protection

Catalog Numbers (Amps)

Catalog Numbers	Amp Rating	Catalog Numbers	Amp Rating
TPA-3	3	TPA-30	30
TPA-5	5	TPA-40	40
TPA-10	10	TPA-50	50
TPA-15	15	TPA-B-20	20
TPA-20	20	TPA-B-25	25
TPA-25	25	TPA-B-30	30

Dimensions - mm (in)

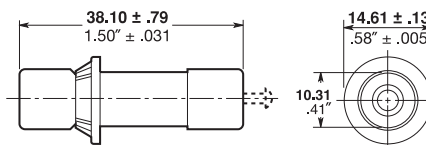

Accessories

- Spare fuse holders: 5 position holder; 5TPH; 6 position holder; TPSFH-AS
- Use with fused disconnect switches TP15900-4, TP15914

Data Sheet: 5012



Fused Disconnect Switches for TPS Fuses

15800

Specifications

Description:

Fused disconnect switch for use only with the following fuses; Main: Telepower TPS 3 to 70 Amp, Alarm: Bussmann GMT-A only (page 399). Recommend GMT-X Cover (page 437).



Dimensions: See Dimensions illustration.

Ratings:

Volts: — 60Vdc
Amps: — 3-70A
SCCR: — 100kA

Agency Information: CE, UL Recognized, Guide QPQY2, File E97649.

Flammability Rating: UL 94V0, 150°C.

Features and Benefits

- Alarm output with wire wrap terminal or connection to 0.063" thick common alarm bus
- Spare alarm and power fuse compartment
- Mounting hardware included

Typical Applications:

- Telecommunications DC power circuit protection

Catalog Numbers

Catalog Numbers	Access Panel Mounting
15800-R-200	Rear
15800-F-200	Front

Dimensions - in (mm)

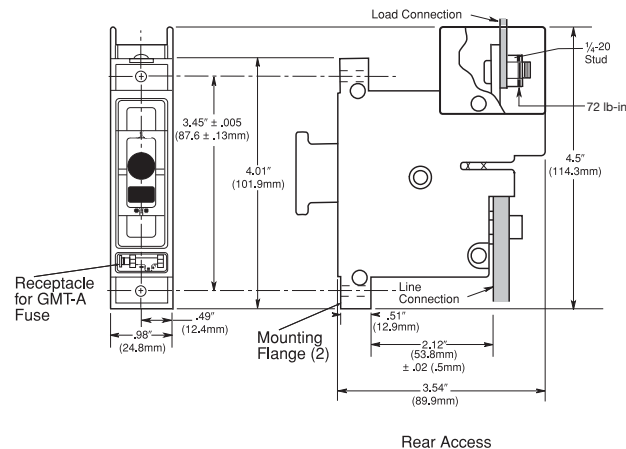

Accessories

- Spare fuse holders: Catalog Numbers TPSFH-AS (TPS fuses) and TPSFH-T (GMT fuses).

Data Sheet: 5002

TPS

Specifications

Description:

DC power distribution non-indicating fuses specifically designed to meet the unique needs of DC power distribution systems. For use with Bussmann fused disconnect switch 15800.



Dimensions: See Dimensions illustration.

Ratings:

Volts: — 170Vdc
Amps: — 1-70A
IR: — 100kA

Agency Information: CE, UL Recognized, Guide JFHR2, File E56412.

Features/Benefits

- The UL Recognized ratings and current-limiting capability make this fuse ideal for cable protection on existing DC power distribution systems
- A unique blue label is used on all Telepower fuses to designate their DC capability
- Printed circuit board variations available

Typical Applications

- Telecommunications DC power circuit protection
- Applications requiring printed circuit board mounting

Catalog Numbers (Amps)

TPS-1	TPS-6L	TPS-30	TPS-50V
TPS-1L	TPS-10	TPS-30L	TPS-60
TPS-2	TPS-10L	TPS-35	TPS-60L
TPS-2L	TPS-15	TPS-35L	TPS-70
TPS-3	TPS-15L	TPS-40	TPS-70L
TPS-3L	TPS-20	TPS-40L	TPS-70LB
TPS-5	TPS-20L	TPS-40V	
TPS-5L	TPS-25	TPS-50	
TPS-6	TPS-25L	TPS-50L	

Dimensions - in (mm)

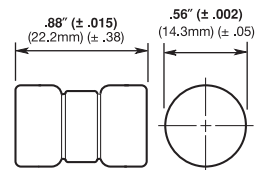

Accessories

- Spare fuse holder: TPSFH-AS, see page 510.

Data Sheet: 5009

Fused Disconnect Switches

TP158HC

Specifications

Description: Panel mount, rear access high amp version of Bussmann 15800 series fused disconnect switch for use only with the following fuses; Main: Telepower TPL-B 70-250 Amps, Alarm: Bussmann GMT-A.

Dimensions: See Data Sheet 5021.

Ratings:

Volts: — 80Vdc
Amps: — 70-250A
SCCR: — 100kA

Agency Information: UL Recognized (investigated to UL 1801) as a disconnect switch for the interruption of load current by means of withdrawing the fuse pullout. Guide QPQY2, File E97649.

Flammability Rating: UL 94V0, 150°C.

Features and Benefits

- Similar profile, mounting method, and backplane configuration as 15800 Series. The TP158HC can be installed into existing 15800 Series panels using the space of two 15800 disconnects
- Innovative new fuse pullout design eliminates need for tools to replace the Telepower type TPL-B fuse
- Alarm output with wire wrap terminal or connection to 0.063 inch (1.6mm) thick common alarm bus
- Hardware included: Load: washer, split lockwasher, and 5/16 - 18 nut (metric-M8 x 1.25)

Typical Applications:

- Telecommunications DC power circuit protection

Catalog Numbers

Catalog Numbers	Hardware
TP158HC	English
TP158HC-M	Metric

Accessories

- Spare fuse holders: TPSFH-LB (TPL-B fuses) and TPSFH-T (GMT fuses).



Application Notes

- The line connection uses a 1/4-20 bolt (metric – M6X1) that threads into the line terminal. The line terminal is designed with a float of ±0.02" (±0.50mm) to allow for variation in the distance between the TP158HC mounting flange and the line busbar (see Dimensions). Equipment should be designed to eliminate any relative movement between the TP158HC mounting flange and the line busbar.
- The alarm circuit is not intended for precharging of capacitive circuits. Alarm circuit current 1A maximum.



Easy Fuse Replacement



Fused Disconnect Switches

15100

Specifications

Description: Fused disconnect system for use with Telepower fuses Type TPL.

Dimensions: See Dimensions illustrations.

Ratings:

Volts: — 60Vdc

Amps: — 70-800A

SCCR: — 100kA

Agency Information: CE, UL Recognized, Guide QPQY2, File E97649.

Features and Benefits

- Single-pole fusible disconnect switch for primary DC power distribution
- Robust housing and terminal construction for demanding applications
- Panel mounting
- Easily connected to line or load bus

Typical Applications

- Telecommunications DC power circuit protection

Catalog Numbers

Catalog Numbers	For Use With TPL Series Fuses
15100-401	70-400A
15100-601	300-800A



Dimensions - in (mm)

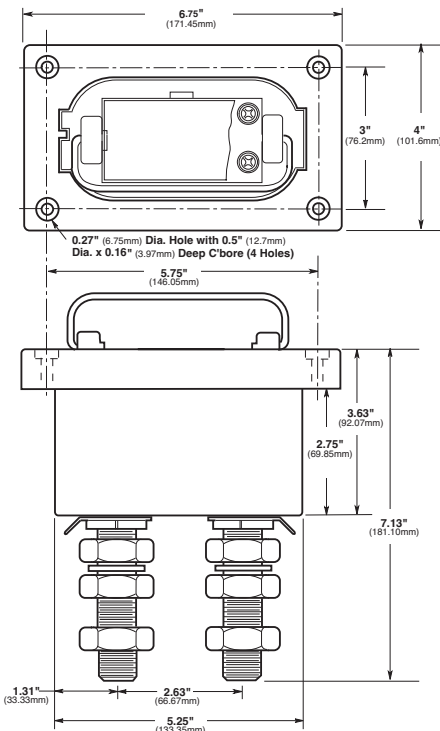

Data Sheet: 5003

Telpower High-current Switch

TPHCS

Specifications

Description: High current switch for use with Telpower fuses Type TPL-B, TPL-C and TPH.

Available as complete switch or pullout. Base may be purchased separately.

Dimensions: See Dimensions illustrations.

Construction:

Ratings:

- Volts: — 80Vdc
- Amps: — 70-800A
- SCCR: — 100kA

Agency Information: UL Recognized (investigated to UL 1801) as a disconnect switch for the interruption of load current by means of withdrawing the fuse carrier. UL Recognized to meet the requirements for Canadian Standards.

Features and Benefits

- Innovative design eliminates need for tools to replace the Telpower™ Type TPL-B, TPL-C or TPH fuse
- Easy to install—captive fasteners allow for direct busbar mounting (bolts not included). Standard 1/4" male quick-connect terminal for effortless remote alarm connection.
- Optional new electronic alarm eliminates need for parallel indicating fuses while providing local and remote open-fuse indications (maximum remote alarm current: 20mA); Bipolar alarm: designed for both Central Office and Radio applications, Local LED alarm indication for ease-of-viewing.
- Fuse presence window allows for easy viewing of installed fuse amp rating

Typical Applications

- Telecommunications DC power circuit protection
- Compact design is ideal for today's high power, high-density cabinets



TPCHS800-MAV (shown)

Catalog Numbers – Switches (Pullout and Base)

Catalog Numbers	Hardware/Option	Fuse Series	Amp Rating
TPHCS250-M	Metric	TPL-B	70-250
TPHCS250-E	English	TPL-B	70-250
TPHCS250-ML	Metric, LED	TPL-B	70-250
TPHCS250-EL	English, LED	TPL-B	70-250
TPHCS250-MAV	Metric, Alarm	TPL-B	70-250
TPHCS250-EAV	English, Alarm	TPL-B	70-250
TPHCS800-M	Metric	TPL-C or TPH	300-800
TPHCS800-E	English	TPL-C or TPH	300-800
TPHCS800-ML	Metric, LED	TPL-C or TPH	300-800
TPHCS800-EL	English, LED	TPL-C or TPH	300-800
TPHCS800-MAV	Metric, Alarm	TPL-C or TPH	300-800
TPHCS800-EAV	English, Alarm	TPL-C or TPH	300-800

Catalog Numbers – Components

Catalog Numbers	Description Rating/Hardware/Option	Fuse Series	Amp Rating
TPHCS250-P	Pullout only – 250A	TPL-B	70-250
TPHCS800-P	Pullout only – 800A	TPL-C or TPH	300-800
TPHCS-B-M	Base only, Metric	—	800 Max
TPHCS-B-E	Base only, English	—	800 Max
TPHCS-B-ML	Base only, Metric, LED	—	800 Max
TPHCS-B-EL	Base only, English, LED	—	800 Max
TPHCS-B-MAV	Base only, Metric, Alarm	—	800 Max
TPHCS-B-EAV	Base only, English, Alarm	—	800 Max

Dimensions - mm (in)

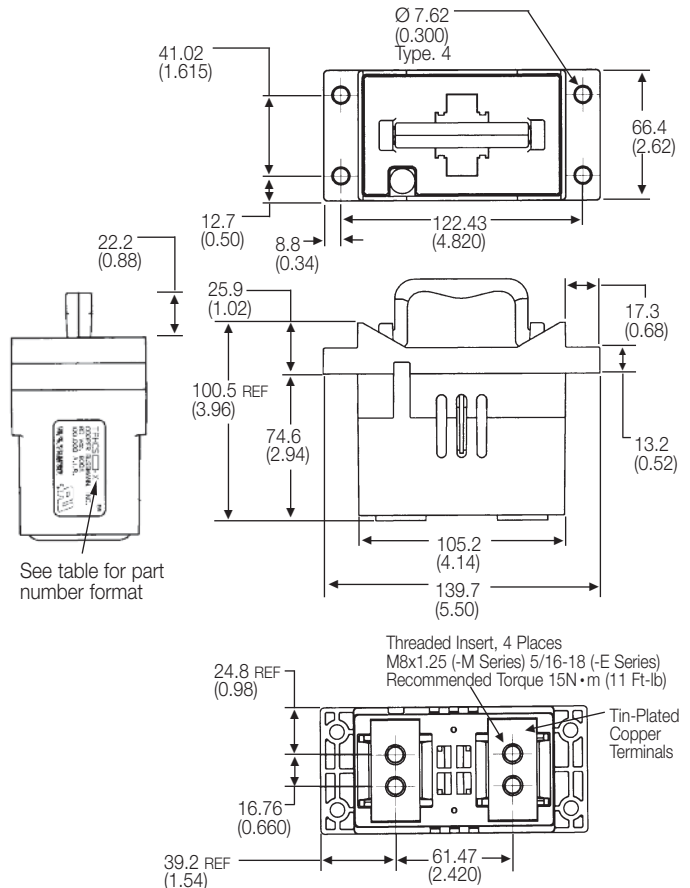

NOTES:

1. TPHCS250 and TPHCS800 pullouts and bases are the same with exception to the type of fuse, TPL-B, TPL-C or TPH the pullout will carry.
2. Plastic rated UL 94V0, 140°C RTI.

Telpower 70-600A: 170Vdc Fuses

TPL

Specifications

Description: DC power distribution fuses for use with Telepower 15100, 15200, TP158HC and TPHCS disconnect systems. For replacement of Bussmann UBO fuses a TPL-TA adapter kit is necessary.

Dimensions: See Dimensions illustrations.

Ratings:

- Volts: — 170Vdc
- Amps: — 70-800A
- IR: — 100kA

Agency Information: CE, UL Recognized Guide JFHR2, File E56412 Bellcore.

Features and Benefits

- Current-limiting capability designed for DC power distribution systems
- Recognized branch circuit protection
- Complete system coordination capability
- Energy savings with low watts loss, low operating temperatures, and minimum I²t levels

Typical Applications

- Telecommunications power circuit protection

Catalog Numbers

Catalog Numbers	Amp Rating
TPL-BA	70
TPL-BB	80
TPL-BC	90
TPL-BD	100
TPL-BE	125
TPL-BF	150
TPL-BG	175
TPL-BH	200
TPL-BK	225
TPL-BL	250
TPL-CN	300
TPL-CO	350
TPL-CR	400
TPL-CU	450
TPL-CV	500
TPL-CZ	600
TPL-CZH	800

Accessories

- Spare fuse holders: TPSFH-LB (for TPL-B fuses)
TPSFH-LC (for TPL-C fuses)



Dimensions - in (mm)

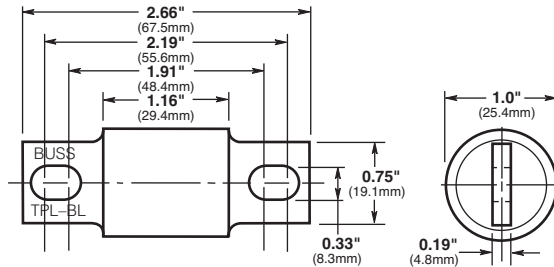

TPL-BA, TPL-BD, TPL-BF, TPL-BH, TPL-BK, and TPL-BL

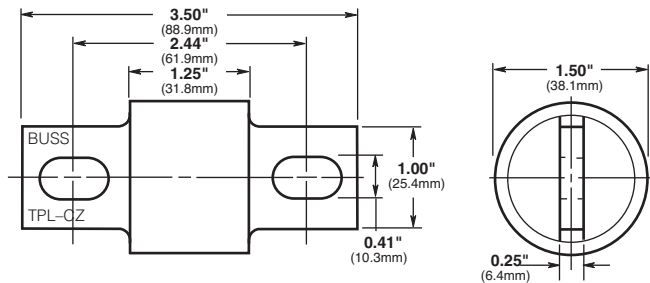

TPL-CN, TPL-CR, TPL-CV and TPL-CZ

Telpower 1-600A, 170Vdc Fuses

TPN

Specifications

Description: Current-limiting DC power distribution fuses. The TPN fuse series is dimensionally similar to Class R fuses making it easy to use standard Class R fuse blocks.



Dimensions: See Dimensions illustrations.

Ratings:

- Volts: — 170Vdc
- Amps: — 1-600A
- IR: — 100kA

Agency Information: UL Recognized, Guide JFHR2, File E56412.

Features/Benefits

- Current-limiting capability designed for DC power distribution systems
- Recognized branch circuit protection
- Complete system coordination capability
- Energy savings with low watts loss, low operating temperatures, and minimum I²t levels

Typical Applications

- Telecommunications power circuit protection

Catalog Numbers (Amps)

TPN-1	TPN-45	TPN-200
TPN-3	TPN-50	TPN-225
TPN-5	TPN-60	TPN-250
TPN-6	TPN-70	TPN-300
TPN-10	TPN-80	TPN-350
TPN-15	TPN-90	TPN-400
TPN-20	TPN-100	TPN-450
TPN-25	TPN-110	TPN-500
TPN-30	TPN-125	TPN-600
TPN-35	TPN-150	
TPN-40	TPN-175	

Dimensions - in (mm)

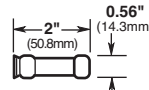

1A to 30A

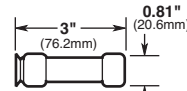

35A to 60A

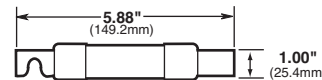

70A to 100A

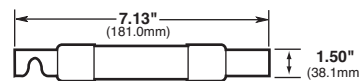

110A to 200A

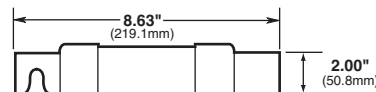

225A to 400A

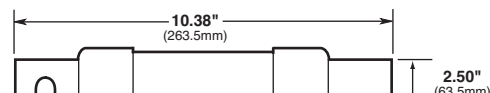

450A to 600A

Accessories

- Spare fuse holders:TPSFH-N30 (for TPN 1-30) TPSFH-N60 (for TPN 35-60)

Recommended Class R Fuse Blocks

Amps	Poles	Catalog Number
1-30	1	R25030-1CR
1-30	2	R25030-2CR
1-30	3	R25030-3CR
35-60	1	R25060-1CR
35-60	2	R25060-2CR
35-60	3	R25060-3CR
70-100	1	R25100-1CR
70-100	2	R25100-2CR
70-100	3	R25100-3CR
110-200	1	R25200-1CR
110-200	3	R25200-3CR
225-400	1	R25400-1CR
225-400	3	R25400-3CR
450-600	1	R25600-1CR
450-600	3	R25600-3CR

Indicating Fuses and Holders

70 Series Fuses

Specifications

Description: Indicating type fuse.

Ratings:

Volts: — 125Vac/300Vdc

Amps: — 1/10-10A

IR: — 1kA @ 300Vdc

Agency Information: CE, UL Recognized, Guide JDYX2, File E19180 Bellcore.

Catalog Numbers

Catalog Numbers	Amp Rating	Color Code	Lucent Comcode Ref. No.	Code/ List No.
70P-1/10A*	1/10	Gray/Wh	100203413	KS23751-L10
70R-1/100A*	1/100	Red/Wh	101384550	KS23751-L11
70E-1/100A*	1/100	Yellow	100203363	KS23751-L5
70X-2/10A	2/10	Black	—	—
70F-1/4A*	1/4	Violet	100203371	KS23751-L6
70K-1/4A*	1/4	Violet/Wh	100203405	KS23751-L9
70G-1/2A*	1/2	Red	100203389	KS23751-L7
70H-3/4A*	3/4	Brown	100203397	KS23751-L8
70I-1A	1	Pink	—	—
70A-1 1/2A*†	1 1/2	White	100203322	KS23751-L1
70B-2A*	2	Orange	100203330	KS23751-L2
70C-3A*	3	Blue	100203348	KS23751-L3
70J-3 1/2A	3 1/2	Black/Wh	—	—
70D-5A*	5	Grn/Blk	100203355	KS23751-L4
70L-6A	6	Grn/Wh	—	—
70M-8A	8	Brown/Wh	—	—
70N-10A	10	Violet/Yel	—	—
GKB-10A	10	Violet/Yel	—	—
72A Plastic Case	Dummy	—	100203421	—
72B Blister Pack	Dummy	—	103757977	—

*Product designed to comply with Bellcore Technical Reference TR-TSY-000799 Issue 1, December 1988.

†No longer UL Recognized.



15087 Fuse Holder

Specifications

Description: Fuse holder for 70 Series fuses.

Ratings:

Volts: — 300Vdc

Amps: — 12A

Agency Information: CE, UL Recognized, Guide IZLT2, File E14853.

Flammability Rating: UL 94V0.



Features and Benefits

- Panel mount fuse holder for 70 Type fuses supplied with two screws
- Remote alarm capability

Typical Applications

- Telecommunications DC power circuit protection

Catalog Number — 15087

Accessories

Description: Optional color code eyelets used with fuse holder to indicate fuse amp rating.

Eyelet Catalog Numbers

Catalog Numbers	Amp Indication	Color Code
1A1706-01	1/100	Yellow
1A1706-02	2/10	Black
1A1706-03	1/4	Violet
1A1706-04	1/4	Violet/White
1A1706-05	1/2	Red
1A1706-06	3/4	Brown
1A1706-07	1	Pink
1A1706-08	1 1/2	White
1A1706-09	2	Orange
1A1706-10	3	Blue
1A1706-11	5	Green/Black
1A1706-12	6	Green/White
1A1706-13	8	Brown/White
1A1706-14	10	Violet/Yellow
1A1706-15	1/10	Gray/White
1A1706-16	3 1/2	Black/White
1A1706-17	15/100	Red/White

Indicating Fuses and Holders

HLS, HLT, PCT

Specifications

Description: Fuse holders for GMT Type indicating fuses.

Poles: 01 to 25.

Ratings:

Volts: — 60Vdc/125Vac

Agency Information:

CE, UL Recognized, Guide IZLT2, File E14853, 15A (60Vdc).

Flammability Rating:

UL 94V0.

Features and Benefits

- Multiple configurations provide application flexibility
- Compact size saves space

Typical Applications

- Telecommunications DC power circuit protection

Catalog Numbers

Catalog Numbers	Poles
PCT	1
HLS	See Build-A-Code
HLT	See Build-A-Code



GMT

Specifications

Description: Fast-acting fuses for use in HLT, HLS, and PCT fuse holders.

Ratings:

Volts: — 60Vdc/125Vac

Amps: — 18/100-15A

IR: — 450A@60Vdc

— 300A@125Vac

Agency Information: CE, UL Recognized, Guide JFHR2, File E56412.

Flammability Rating: UL 94V0.

Features and Benefits

- Local and remote indication capability
- Color coded for easy amp rating identification

Typical Applications

- Telecommunications DC power circuit protection

Catalog Numbers

Catalog Numbers	Color Code	Catalog Numbers	Color Code
GMT-18/100A	Yellow	GMT-3-1/2A	White/Blue
GMT-1/4A	Violet	GMT-4A	White/Brown
GMT-3/8A	Green/Gray	GMT-5A	Green
GMT-1/2A	Red	GMT-7-1/2A	Black/White
GMT-65/100A	Black	GMT-10A	Red/White
GMT-3/4A	Brown	GMT-12A	Yellow/Green
GMT-1A	Gray	GMT-15A	Red/Blue
GMT-1-1/2A	White	GMT-Dummy	Gray Body
GMT-1-1/2A	White/Yellow	GMT-X	Clear Cover
GMT-2A	Orange	GMT-Y	Clear Cover
GMT-3A	Blue		

Some GMT sizes may be sold in bulk pack only.

Accessories

- Spare fuse holder: Catalog Number TPSFH-T

GMT-A

Specifications

Description: Fast-acting fuse designed specifically for use in the Telepower series 15800 fused disconnect switch (page 430).

Agency Information: The GMT-A has the same ratings and agency approvals as the standard GMT fuses as shown above.

Catalog Numbers

Catalog Number	Color Code
GMT-A	Yellow

Multiple Fuse holders with bus bars Ordering Information— Catalog No.

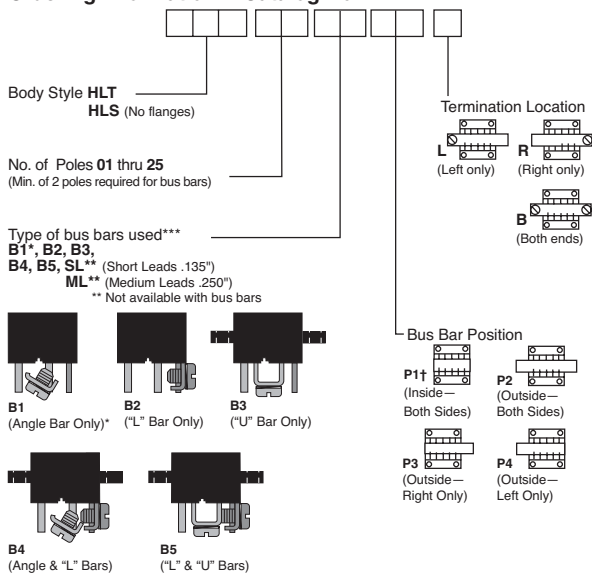

*Angle Bar mounts on common or center terminals only.
**SL Version is not available with bus bars.
†Minimum of 4 Poles Required.
***.38 max. leads if not specified.

Telpower Specialty Fuses

7 Type



Specifications

Description: Fiber tube, threaded ends. Typically used on wall type main distribution frames and central battery substations.

Dimensions: See Catalog Numbers table and Dimensions illustration.

Ratings:

Amps: — 7A

Agency Information: CE

Catalog Numbers

Catalog Numbers	Amp Rating	Lucent Comcode Ref. No.	Dimension A Length (in)
7A-7	7	100863737	4.562
7T-7	7	100202753	4.828

Dimensions - in

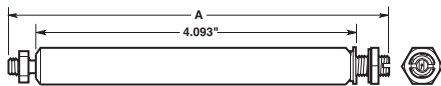

11 Type



Specifications

Description: Fiber tube, threaded ends, identical to 7 Type except for vent slots in fiber tube.

Dimensions: See Dimensions illustration.

Ratings:

Amps: — 7A

Agency Information: CE

Catalog Number

Catalog Number	Amp Rating	Lucent Comcode Ref. No.
11C-7	7	100863745

Dimensions - in

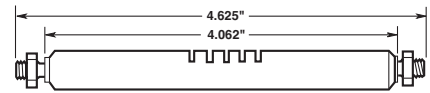

24 and WER Type

Specifications

Description: Flat, non-indicating visible link element mounted on 1 inch centers using either No. 6 or No. 10 screws.

Dimensions: See Dimensions illustration.

Ratings:

Volts: — 32Vdc (¼, 1, 3 ½, 8, 10A)

— 60Vdc (½, ¾, 1 ½, 2, 3, 4, 5A)

Amps: — ¼-10A

Agency Information: CE, UL Recognized File E56412.

Catalog Numbers

Catalog Numbers	Amp Rating	DC Volts	Color Code	Lucent Comcode Ref. No.	A Length Inches
WER-¼	¼	32	—	—	—
24E-½*	½	60	Red	100202894	0.20
24D-¾*	¾	60	Black	100202886	0.15
WER-1	1	32	—	—	—
24G-1-½*	1 ½	60	White	100202910	0.20
24C-2*	2	60	Orange	100202878	0.20
24B-3*	3	60	Blue	100202852	0.15
WER-3-½	3 ½	32	—	—	—
24B-4*	4	60	Yellow	100202860	0.15
24F-5*	5	60	Green	100202902	0.15
WER-8	8	32	—	—	—
WER-10	10	32	—	—	—

*Designed to comply with Bellcore Technical Reference TR-TSY-000799 Issue 1, Dec. 1988.

Dimensions - in

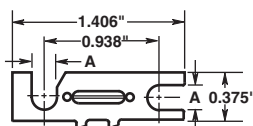

74 Type



Specifications

Description: Fast-acting 0.281" x 1.25" cylindrical fuse designed to comply with Lucent specification KS23753. High current companion to 70 Type Fuse.

Dimensions: See Dimensions illustration.

Ratings:

Volts: — 60Vdc

Amps: — 1 ¼-20A

Agency Information: CE, UL Recognized File E19180.

Catalog Numbers

Catalog Numbers	Amp Rating	Lucent Comcode Ref. No.	Code/List No.
74A-1-¼	1 ¼	102630290	KS23753-L1
74G-2	2	103064952	KS23753-L7
74B-3	3	102630308	KS23753-L2
74H-4	4	103264669	KS23753-L8
74C-5	5	102630316	KS23753-L3
74J-7-½	7 ½	103228425	KS23753-L9
74D-10	10	102630324	KS23753-L4
74E-15	15	102630332	KS23753-L5
74F-20	20	102630340	KS23753-L6

Dimensions - in (mm)

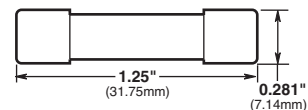

Telpower Specialty Fuses

75 Type

Specifications

Description: Cylindrical with leads, designed to provide protection against currents resulting from the application of foreign voltages. Application for data sets and telephones.

Dimensions: See Dimensions illustration.

Ratings:

Volts: — 135Vac/220Vdc (440Vdc@0.007A)

Amps: — 0.007-0.230A

Agency Information: CE

Catalog Numbers

Catalog Numbers	Amp Rating	Lucent Comcode Ref. No.	Code/ List No.
75C	0.007	103260816	KS23825-L3
75F	0.063	104172861	KS23825-L6
75B	0.115	102732112	KS23825-L2
75D	0.129	104013180	KS23825-L4
75A	0.200	102660008	KS23825-L1

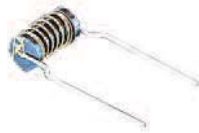
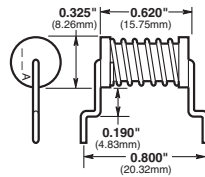

76 Type

Specifications

Description: Cylindrical with leads, designed to provide protection against currents resulting from the application of foreign voltages. Application for data sets and telephones.

Dimensions: See Dimensions illustration.

Ratings:

Volts: — 135Vac/440Vdc

Amps: — 0.012-0.412A

Agency Information: CE

Catalog Numbers

Catalog Numbers	Amp Rating	Lucent Comcode Ref. No.	Code/ List No.
76D	0.012	103798245	KS23825-L10
76B	0.191	102965688	KS23825-L8
76A	0.231	102810181	KS23825-L7
76C	0.412	103656625	KS23825-L9

Dimensions - in (mm)

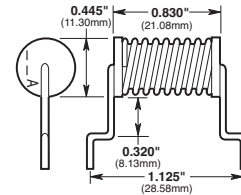

80 Type

Specifications

Description: A fuse designed for high reliability applications where high ambient temperatures, low circuit voltages, low power dissipation and low contact resistance are prime considerations. The 80 Type is a visual indicating fuse with remote electrical alarm capability. UL Recognized, Guide JDYX2, File E19180.

Dimensions: See Dimensions illustrations.

Ratings:

Volts: — 160Vdc

Amps: — ½-5A

Agency Information: CE, UL Recognized File E19180.

Catalog Numbers

Catalog Numbers	Amp Rating	Color Code	Lucent Comcode Ref. No.	Code/ List No.
80G-½	½	Red	103839916	KS23824-L6
80M-1-½	1½	White	408078657	KS23824-L8
80B-2	2	Orange	103752150	KS23824-L2
80C-3	3	Blue	103752168	KS23824-L3
80D-5	5	Green	103800637	KS23824-L4

Dimensions - in (mm)

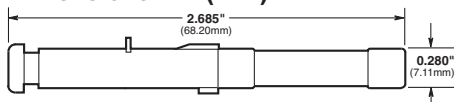

Surge Protection Made Simple™

UL 508A Applications



Comprehensive UL 1449 3rd Edition recognized surge protection solutions for North American applications.

Bussmann
by **EAT•N**



Scan this tag to get product information about the New Bussmann Surge Protection products for UL, PV, IEC, Wind Power and Telecom applications.

RED indicates **NEW** information

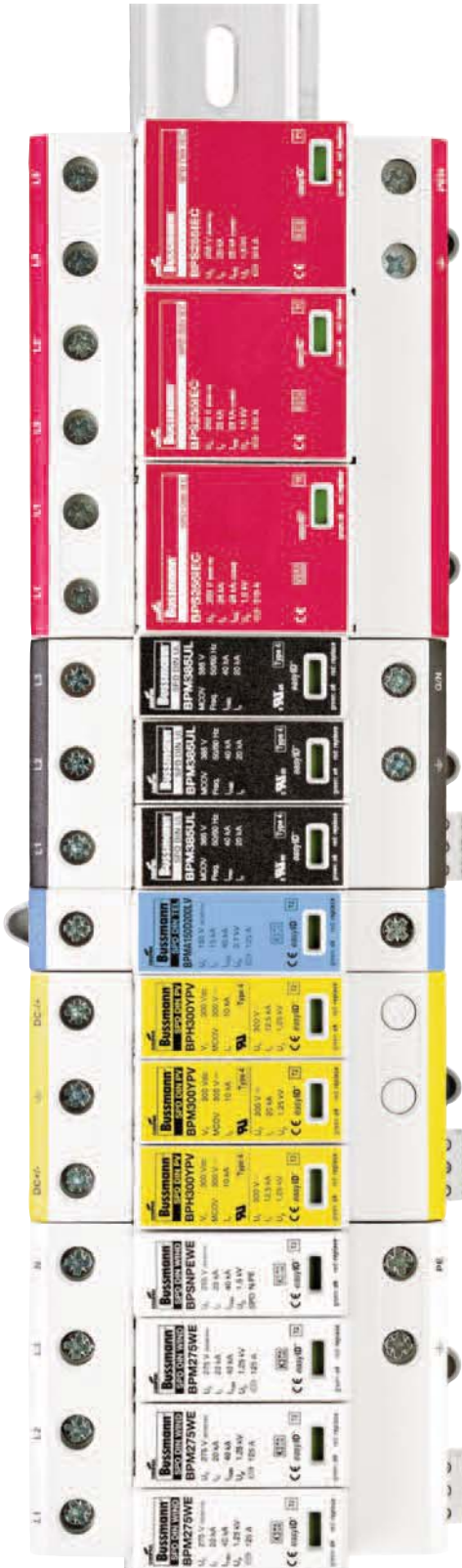

Overvoltage Protective Devices

Surge Protective Devices

UL Type 1 NEMA 4X SPDs

SurgePOD HEAVY DUTY (Black Label)	442-445
SurgePOD PRO (Grey Label)	446-448

UL DIN-Rail

High SCCR SPDs

1-Pole Type 2	BSPM_S2G	449-450
2-Pole Type 2	BSPM_S3G	451-452
3-Pole Type 2	BSPM_WYG/DLG.....	453-454
4-Pole Type 2	BSPM_WYNG/HLG.....	455-456

Low Voltage AC/DC Power

1-Pole Type 2	BSPM_LV.....	457-458
---------------	--------------	---------

Low-Voltage AC/DC Control

2-Pole Type 3	BSPH2A_LV.....	459-460
---------------	----------------	---------

IEC DIN-Rail

Class I

2-Pole Class I	BSPS_TN/TT	461-462
3-Pole Class I	BSPS_TNC	463-464
4-Pole Class I	BSPS_TNS/TT	465-466

Class II

1-Pole Class II	BSPM_TN / BSPG_NPE.....	467-468
2-Pole Class II	BSPM_TN / BSPH_TT	469-470
3-Pole Class II	BSPM_TNC	471-472
4-Pole Class II	BSPM_TNS / BSPH_TT	473-474

Solar Power Photovoltaic (PV) DIN-Rail

Lightning Arrester

1-Pole PV Advance Lightning Arrester /	BSPS_PV	475-476
--	---------------	---------

Overvoltage Surge Protective Devices

2-Module	PV HEAVY DUTY SPD /	BSPH2_PV	477-478
3-Module	PV HEAVY DUTY SPD /	BSPH_YPV	479-480
3-Module	PV PRO SPD / BSPH_YPV.....	481-482	

Wind Power IEC DIN-Rail

Class I

1-pole Class I	BSPS_WE.....	483-484
----------------	--------------	---------

Class II

1-Pole Class II	BSPM_WE / BSPS_WE.....	485-486
2-Pole Class II	BSPM_WE / BSPH_WE	487-488
3-Pole Class II	BSPM_WE.....	489-490
4-Pole Class II	BSPM_WE / BSPH_WE	491-492

UL 4978 Data Signal SPDs

DIN-Rail BNC/Coaxial Cable	BSPD5BNCD_	493-494
In-Line BNC/Coaxial Cable	BSPD5BNCSI	495-496
DIN-Rail RJ45/Ethernet Cable	BSPD48RJ45	497-498
DIN-Rail Universal 4 Wire	BSPD_DIN.....	499-501

Surge Protective Overvoltage Device Modules

SurgePod™ Series, 150 to 550Vac MCOV	502-503
DIN-Rail TVS Series with Holder	504



Scan this tag to get access to the Surge Protective Devices Cross Reference Search.

Surge Protection Devices

SURGE PROTECTION MADE SIMPLE™ FOR COMMERCIAL & INDUSTRIAL APPLICATIONS
SURGEPOD™ HEAVY DUTY SPD FOR UL 1449 3rd Edition Listed Loadside and Lineside Protection

Description

The Bussmann SurgePOD™ HEAVY DUTY is a Type 1 UL Listed 1449 3rd Edition surge protective device suitable for installation on both the loadside or lineside of the service entrance overcurrent protective device.

Available in voltage and system specific versions to match electrical system and equipment requirements. The SurgePOD HEAVY DUTY delivers optimum surge protection using advanced patent pending SurgePOD™ module featuring thermal disconnect technology that eliminates the need for additional overcurrent protection.

Parallel connection to the electrical system permits the SurgePOD HEAVY DUTY SPD to be installed on **any** ampacity panel.

- Type 1 UL 1449 3rd Edition Listed SPDs are easily selected and installed on the loadside or lineside of the service entrance overcurrent protective device
- Patented Bussmann SurgePOD module technology eliminates the need for additional fusing
- Voltage specific models precisely match and protect electrical systems and equipment up to 600Vac
- Compact UV resistant NEMA 4X for indoor or outdoor applications
- easyID™ LED status indicator provides surge protection status at a glance

Dimensions - in

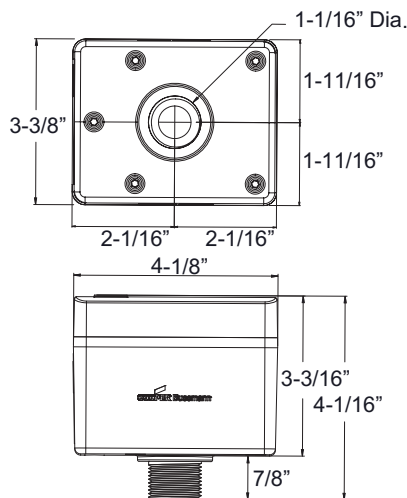

SPH50SP1120SN	SPH50SP2480PN	SPH50SP3208WYG
SPH50SP1240SN	SPH50SP3240PNG	SPH50SP3480WYG
SPH50SP1347SN	SPH50SP3480PNG	SPH50SP3600WYG
SPH50SP2120SNG	SPH50SP3240DLG	SPH50SP4208WYNG
SPH50SP2240SNG	SPH50SP3480DLG	SPH50SP4480WYNG
SPH50SP2347SNG	SPH50SP4240HLG	SPH50SP4600WYNG
SPH50SP2240PN	SPH50SP4480HLG	

**NEMA 4X Rated Heavy Duty
Type 1 UL Listed SPD**

Type 1 SPD Part Number System

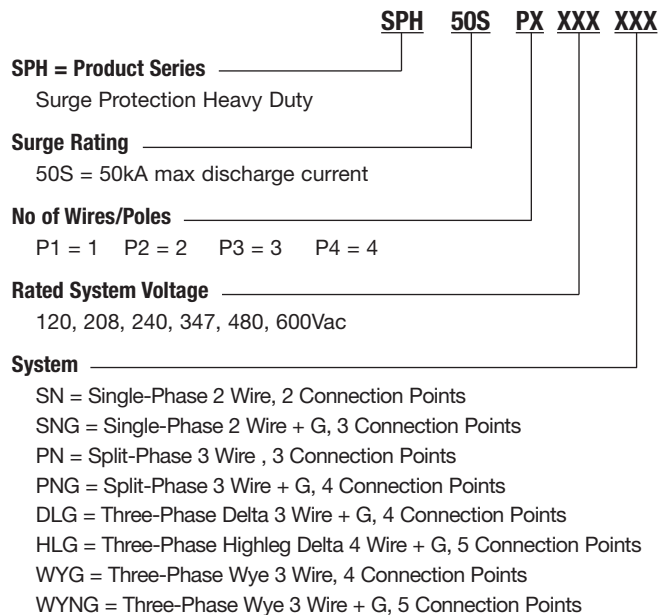

SurgePOD™ HEAVY DUTY Technical Information

Catalog Number	Nominal System Voltage	Max. Continuous Operating AC Voltage (MCOV) (V _C)	System Type	Connection Points
SPH50SP1120SN	120V	150V	Single-Phase 2 Wire	2
SPH50SP1240SN	240V	320V	Single-Phase 2 Wire	2
SPH50SP1347SN	347V	420V	Single-Phase 2 Wire	2
SPH50SP2120SNG	120V	150V	Single-Phase 2 Wire + G	3
SPH50SP2240SNG	240V	320V	Single-Phase 2 Wire + G	3
SPH50SP2347SNG	347V	420V	Single-Phase 2 Wire + G	3
SPH50SP2240PN	120/240V	150V	Split-Phase 3 Wire	3
SPH50SP2480PN	240/480V	320V	Split-Phase 3 Wire	3
SPH50SP3240PNG	120/240V	150V	Split-Phase 3 Wire + G	4
SPH50SP3480PNG	240/480V	320V	Split-Phase 3 Wire + G	4
SPH50SP3240DLG	240V	320V	Three-Phase Delta 3 Wire + G	4
SPH50SP3480DLG	480V	550V	Three-Phase Delta 3 Wire + G	4
SPH50SP4240HLG	120/240V	150/320V	Three-Phase Highleg Delta 4 Wire + G	5
SPH50SP4480HLG	240/480V	320/550V	Three-Phase Highleg Delta 4 Wire + G	5
SPH50SP3208WYG	208V	150V	Three-Phase Wye 3 Wire + G	4
SPH50SP3480WYG	480V	320V	Three-Phase Wye 3 Wire + G	4
SPH50SP3600WYG†	600V	420V	Three-Phase Wye 3 Wire + G	4
SPH50SP4208WYNG	208Y/120V	150V	Three-Phase Wye 4 Wire + G	5
SPH50SP4480WYNG	480Y/277V	320V	Three-Phase Wye 4 Wire + G	5
SPH50SP4600WYNG†	600Y/347V	420V	Three-Phase Wye 4 Wire + G	5

† 600V Wye versions are not CSA Certified.

SurgePOD™ HEAVY DUTY Technical Information

Specifications (for all SurgePOD HD units)	Values
Short Circuit Current Rating (SCCR)	200kA
Nominal Discharge Current (8x20µs) I _n	20kA
Max. Discharge Current (8x20µs) I _{max}	50kA
Response Time t _A	<25ns
Frequency	50/60Hz
Operating State/Fault Indication	Bi-Color LED - Green (good) / Red (replace)
Conductor Length / Gauge	18 inches, 10 AWG Stranded Tinned Copper
Mounting	Chase Nipple / Bracket*
Enclosure / Flammability Ratings	NEMA 4X - UL 94-5VA
Degree of Protection (Installed State)	IP20 (finger-safe)
SPD Install Location	Indoor/Outdoor
Circuit Location	Lineside or Loadside of service entrance overcurrent protective device
Standard	UL 1449 3 rd Edition Type 1 Listed SPD
Agency Information	cULus, CSA**, RoHS Compliant
Product Warranty	5 Years***
Operating Temperature	-40°C to +85°C
Maximum Operating Altitude	16,000FT

* Customer-supplied bracket.

** 600V Wye versions not CSA Certified.

*** See Bussmann SPD Limited Warranty Statement (3A1502) for details at www.cooperbussmann.com/Surge.

Voltage Protection Ratings (VPRs)

Catalog Number	Rated System Voltage (V _o)	MCOV (V _C)	Voltage Protection Ratings (VPRs)			
			L-N	L-L	L-G	N-G
SPH50SP1120SN	120V	150V	700	—	—	—
SPH50SP1240SN	240V	320V	1200	—	—	—
SPH50SP1347SN	347V	420V	1500	—	—	—
SPH50SP2120SNG	120V	150V	700	—	1200	700
SPH50SP2240SNG	240V	320V	1200	—	2500	1200
SPH50SP2347SNG	347V	420V	1500	—	2500	1500
SPH50SP2240PN	120V/240V	150V	700	1200	—	—
SPH50SP2480PN	240V/480V	320V	1200	2500	—	—
SPH50SP3240PNG	120V/240V	150V	700	1200	1200	700
SPH50SP3480PNG	240V/480V	320V	1200	2500	2500	1200
SPH50SP3240DLG	240V	320V	—	2500	1200	—
SPH50SP3480DLG	480V	550V	—	3000	1800	—
SPH50SP4240HLG	120/240V	150V/320V	700/1200	1200/2500	1200/2500	700/1200
SPH50SP4480HLG	240/480V	320V/550V	1200/1800	2500/3000	2500/3000	1200/1800
SPH50SP3208WYG	208V	150V	—	1200	700	—
SPH50SP3480WYG	480V	320V	—	2500	1200	—
SPH50SP3600WYG [†]	600V	420V	—	2500	1500	—
SPH50SP4208WYNG	208Y/120V	150V	700	1200	1200	700
SPH50SP4480WYNG	480Y/277V	320V	1200	2500	2500	1200
SPH50SP4600WYNG [†]	600Y/347V	420V	1500	2500	2500	1500

† 600V Wye versions are not CSA Certified.

easyID™ LED Status Indicator

The easyID™ LED status indicator will illuminate when the unit is properly installed and the system or equipment being protected is energized. The following LED color/status indicates:



GREEN LED = Good

The circuit is energized and *protected*.



RED LED = Replace

The circuit is *energized and unprotected*.

The unit **needs** replacing.



LED is Out / Unlit:

- The circuit is most likely deenergized
- The unit's leads are disconnected
- The unit is damaged

Authorized personnel should follow all prescribed lockout/tagout and safety procedures in troubleshooting the cause for the above conditions. Opening SurgePOD HEAVY DUTY enclosure will void UL listing and warranty.

Mounting

SurgePOD HEAVY DUTY is a panel mount device. It may also be mounted using a customer supplied bracket or directly onto a female threaded conduit fitting.

For NEMA 4X installation, install appropriate customer supplied gasket between SurgePOD™ HEAVY DUTY SPD and enclosure wall.

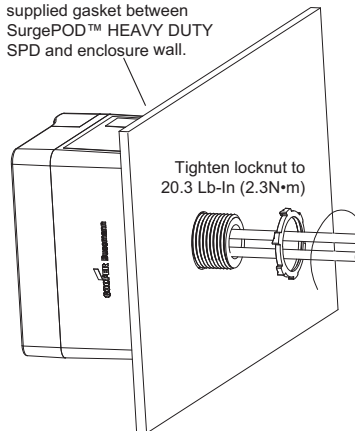

Wiring Connections

Single-Phase

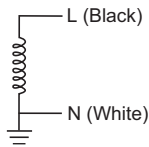

120, 240, 347V (L-N)
2 Wire

Must be installed within 10 feet (3m) of a bonded neutral-ground connection per IEEE C62.41-1991

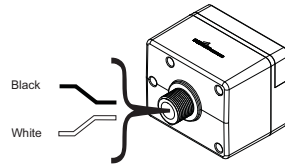

SPH50SP1120SN,
SPH50SP1240SN,
SPH50SP1347SN

Wye + Ground

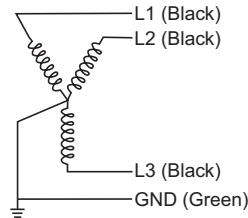

208, 480, 600V (L-L)
3 Wire Wye + Ground

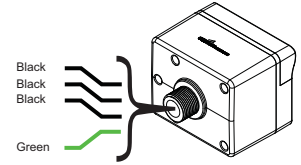

SPH50SP3208WYG,
SPH50SP3480WYG,
SPH50SP3600WYG

Two-Pole with Neutral

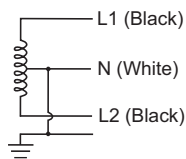

120V (L-N) / 240V (L1-L2),
240V (L-N) / 480V (L1-L2)
Single Phase (Split) Center Tap

For installations at or less than 10 feet (3m) from the transformer.

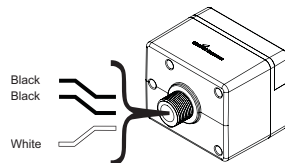

SPH50SP2240PN,
SPH50SP2480PN

Wye with Neutral + Ground

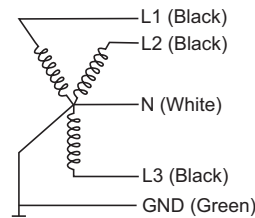

120V (L-N) / 208V (L-L),
127V (L-N) / 220V (L-L),
277V (L-N) / 480V (L-L),
347V (L-N) / 600V (L-L)
4 Wire Wye + Ground

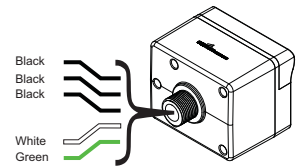

SPH50SP4208WYNG,
SPH50SP4480WYNG,
SPH50SP4600WYNG

Single-Phase + Ground

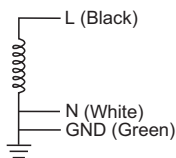

120, 240, 347V (L-N)
2 Wire + Ground

For installation when located greater than 10 feet (3m) of a bonded neutral-ground connection.

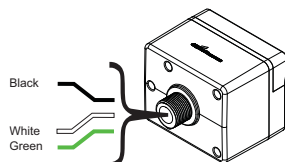

SPH50SP2120SNG,
SPH50SP2240SNG,
SPH50SP2347SNG

Delta + Ground

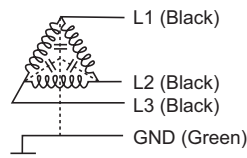

240, 480V (L-L)
3 Wire Delta + Ground

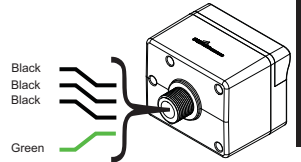

SPH50SP3240DLG,
SPH50SP3480DLG

Two-Pole with Neutral + Ground

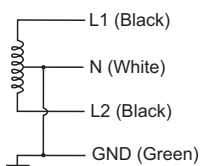

120V (L-N) / 240V (L1-L2),
240V (L-N) / 480V (L1-L2)

Single Phase (Split) Center Tap + Ground

For installation when located greater than 10 feet (3m) of a bonded neutral-ground connection.

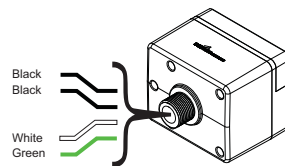

SPH50SP3240PNG,
SPH50SP3480PNG

Highleg Delta

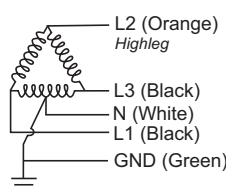

120V (L1 / L3-N) / 240V (L-L),
240V (L1 / L3-N) / 480V (L-L)
4 Wire Highleg Delta + Ground

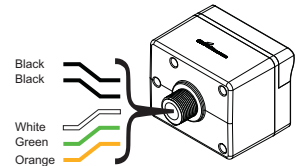

SPH50SP4240HLG,
SPH50SP4480HLG

SURGE PROTECTION MADE SIMPLE™ FOR LIGHT COMMERCIAL & RESIDENTIAL APPLICATIONS
SURGEPOD™ PRO SPD FOR UL 1449 3rd Edition Listed Loadside and Lineside Protection



Description

The Bussmann SurgePOD™ PRO is a Type 1 UL Listed 1449 3rd Edition surge protective device suitable for installation on both the loadside or lineside of the service entrance overcurrent protective device.

Available in popular voltage and system specific versions to match common residential and light commercial electrical system and equipment requirements. The SurgePOD PRO delivers superior surge protection using MOV thermal disconnect technology that eliminates the need for additional overcurrent protection.

Parallel connection to the electrical system permits the SurgePOD PRO SPD to be installed on **any** ampacity panel.

- Type 1 UL 1449 3rd Edition Listed SPDs are easily selected and installed on the loadside or lineside of the service entrance overcurrent protective device
- Voltage specific models precisely match and protect electrical systems and equipment better than “one-size-fits-all” SPDs
- Thermal disconnect technology eliminates the need for additional fusing
- Compact UV resistant NEMA 4X enclosure for indoor or outdoor applications
- easyID™ LED status indicator provides surge protection status at a glance

Dimensions - in

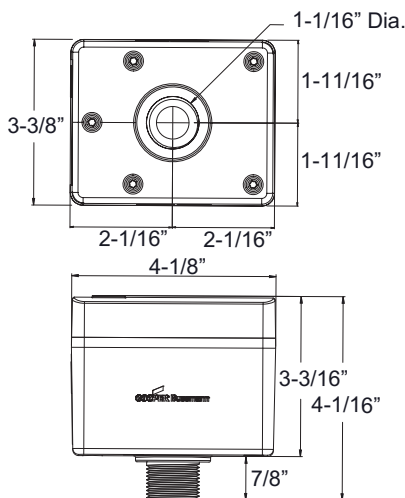

- | | | |
|----------------------|-----------------------|-----------------------|
| SPP40SP1120SN | SPP40SP3240DLG | SPP40SP3208WYG |
| SPP40SP2240PN | SPP40SP3480DLG | SPP40SP3480WYG |

**NEMA 4X Rated Pro
Type 1 UL Listed SPD**

Type 1 SPD Part Number System

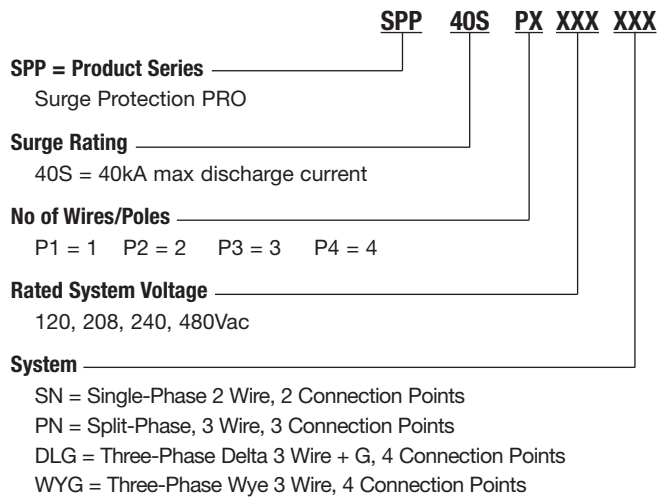

SurgePOD™ PRO Technical Information

Catalog Number	Nominal System Voltage	Max. Continuous Operating AC Voltage (MCOV) (V _C)	System Type	Connection Points
SPP40SP1120SN	120V	150V	Single-Phase 2 Wire	2
SPP40SP2240PN	120/240V	150V	Split Phase 3 Wire	3
SPP40SP3240DLG	240V	320V	Three-Phase Delta 3 Wire + G	4
SPP40SP3480DLG	480V	550V	Three-Phase Delta 3 Wire + G	4
SPP40SP3208WYG	208V	150V	Three-Phase Wye 3 Wire + G	4
SPP40SP3480WYG	480V	320V	Three-Phase Wye 3 Wire + G	4

Specifications (for all SurgePOD PRO units)	Values
Short Circuit Current Rating (SCCR)	200kA
Nominal Discharge Current (8x20μs) I _n	10kA
Max. Discharge Current (8x20μs) I _{max}	40kA
Response Time (ns) t _A	<25ns
Frequency	50/60Hz
Operating State/Fault Indication	Bi-Color LED - Green (good) / Red (replace)
Conductor Length / Gauge	18 inches, 10 AWG Stranded Tinned Copper
Mounting	Chase Nipple / Bracket*
Enclosure / Flammability Ratings	NEMA 4X - UL 94-5VA
Degree of Protection (Installed State)	IP20 (finger-safe)
SPD Install Location	Indoor/Outdoor
Circuit Location	Lineside or Loadside of service entrance overcurrent protective device
Standard	UL 1449 3 rd Edition Type 1 Listed SPD
Agency Information	cULus, RoHS Compliant
Product Warranty	2 Years**
Operating Temperature	-40°C to +65°C
Maximum Operating Altitude	12000FT

* Customer-supplied bracket.

** See Bussmann SPD Limited Warranty Statement (3A1502) for details at www.cooperbussmann.com/Surge.

Voltage Protection Ratings (VPRs)

Catalog Number	Nominal System Voltage	MCOV (V _C)	Voltage Protection Ratings (VPRs)		
			L-N	L-L	L-G
SPP40SP1120SN	120V	150V	700	—	—
SPP40SP2240PN	120V/240V	150V	700	1200	—
SPP40SP3240DLG	240V	320V	—	2500	1200
SPP40SP3480DLG	480V	550V	—	3000	1800
SPP40SP3208WYG	208V	150V	—	1200	700
SPP40SP3480WYG	480V	320V	—	2500	1200

easyID™ LED Status Indicator

The easyID™ LED status indicator will illuminate when the unit is properly installed and the system or equipment being protected is energized. The following LED color/status indicates:



GREEN LED = Good

The circuit is energized and *protected*.



RED LED = Replace

The circuit is *energized and unprotected*.

The unit **needs** replacing.



LED is Out / Unlit:

- The circuit is most likely deenergized
- The unit's leads are disconnected
- The unit is damaged

Authorized personnel should follow all prescribed lockout/tagout and safety procedures in troubleshooting the cause for the above conditions. Opening SurgePOD PRO enclosure will void UL listing and warranty.

Mounting

SurgePOD PRO is a panel mount device. It may also be mounted using a customer supplied bracket or directly onto a female threaded conduit fitting.

For NEMA 4X installation, install appropriate customer supplied gasket between SurgePOD™ PRO SPD and enclosure wall.

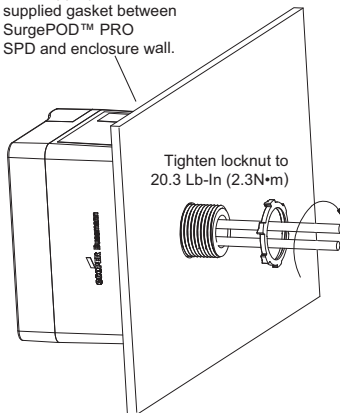

Wiring Connections

Single-Phase

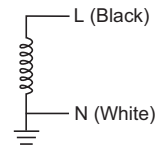

120V (L-N)
2 Wire

Must be installed within 10 feet (3m) of a bonded neutral-ground connection per IEEE C62.41-1991

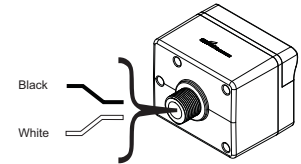

SPP40SP1120SN

Two-Pole with Neutral

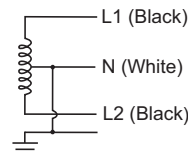

120V (L-N) / 240V (L1-L2),
Single Phase (Split) Center Tap

For installations at or less than 10 feet (3m) from the transformer.

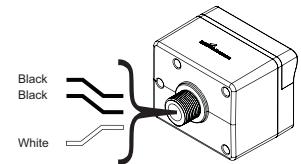

SPP40SP2240PN,

Wye + Ground

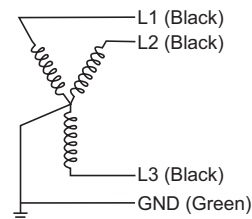

208, 480V (L-L)
3 Wire Wye + Ground

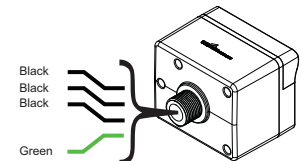

**SPP40SP3208WYG,
SPP40SP3480WYG**

Delta + Ground

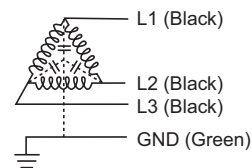

240, 480V (L-L)
3 Wire Delta + Ground

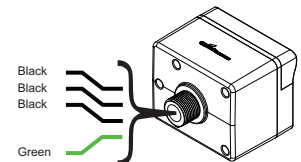

**SPP40SP3240DLG,
SPP40SP3480DLG**

UL DIN-Rail SPD - High SCCR

BSPM__ __ _S2G

Dimensions - mm



easyID™
Visual Status Indication



Remote Signal
Contact Available

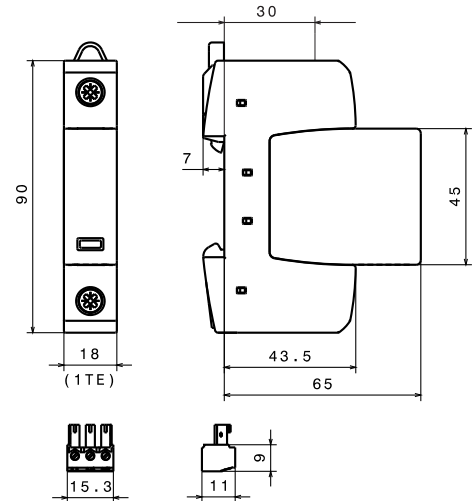

Shown with optional remote contact signaling

Specifications

Description

The Bussmann single pole UL modular surge arresters for 120, 240 and 347Vac single-phase systems feature local, *easyID™* visual indication and optional remote contact signaling. The unique module locking system fixes the protection module to the base part. Modules can be easily replaced without tools by simply depressing the release buttons. Integrated mechanical coding between the base and protection module ensures against installing an incorrect replacement module.

Features

- Surge arrester according to UL 1449 3rd Edition, Type 2 Component Assembly helps meet UL 508A requirements
- Heavy-duty zinc oxide varistors for high discharge capacity
- "Thermo Dynamic Control" SPD monitoring device ensures high reliability against surge events
- Module locking system with module release button makes module replacement easy without tools
- Up to 200kA Short-Circuit Current Rating (SCCR) makes higher *assembly* SCCR ratings possible
- Optional remote signaling of all protection modules makes status monitoring easy and accurate in any monitoring scheme
- No upstream overcurrent protection necessary to make installation easier and more economical
- Vibration and shock tested according to EN 60068-2 to withstand harsh environments

Optional Remote Signaling Contact

The remote signaling contact versions have a floating changeover contact for use as a break or make contact for easy adoption in any monitoring application.

Data Sheet: 2149

Circuit Diagram

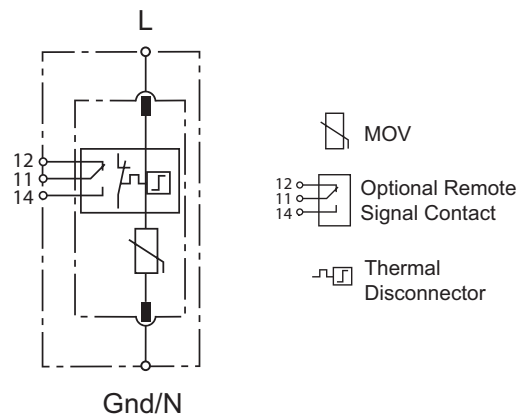

BSPM1120S2G, BSPM1240S2G, BSPM1347S2G*

Shown with optional remote contact signaling

*For remote signaling contact, add "R" suffix to the part number, E.g., BSPM1347S2GR

UL DIN-Rail SPD - High SCCR

ORDERING INFORMATION				
Nominal System Voltage	120Vac	240, 277 or 240 & 277Vac	347Vac	
Max. Continuous Operating AC Voltage (MCOV) [V _C]	275Vac	385Vac	600Vac	
Catalog Numbers:	Without Remote Signaling	BSPM1120S2G	BSPM1240S2G	BSPM1347S2G
	With Remote Signaling	BSPM1120S2GR	BSPM1240S2GR	BSPM1347S2GR
Replacement Module	MOV Technology	BPM275UL	BPM385UL	BPM600UL
SPECIFICATIONS				
Rated Voltage	120-127Vac	240-277Vac	347Vac	
Voltage Protection Rating V _{PR}	1kV	1.5kV	2kV	
SCCR	200kA	200kA	125kA	
Nominal Discharge Current I _n (kA)		20kA		
Max. Discharge Current I _{max} (kA)		40kA		
Response Time t _A		≤25 ns		
Frequency		50/60Hz		
Number of Poles		1		
Number of Wires/Connection Points		2 Wires / 2 Connection Points		
Operating State/Fault Indication		Green (good) / Red (replace)		
Cross-Sectional Area (min.)		14AWG - Cu Stranded, Solid or Fine		
Cross-Sectional Area (max.)		2AWG - Cu Solid or Stranded / 4AWG - Cu Fine		
Terminal Torque		45 lb-in		
For Mounting On		35mm DIN Rail per to EN 60715		
Enclosure Material		Thermoplastic, UL 94V0		
Degree of Protection		IP20 (finger-safe)		
Location Category		Indoor		
Capacity		1 Mods, DIN 43880		
Application		UL Type 2 Component Assembly		
Standard		UL 1449, 3 rd Edition		
Agency Information		cURus, CSA, RoHS Compliant		
Product Warranty		Five Years*		
REMOTE CONTACT SIGNALING				
Remote Contact Signaling Type		Changeover Contact		
AC Switching Capacity (Volts/Amps)		250V/0.5A		
DC Switching Capacity (Volts/Amps)		250V/0.1A; 125V/0.2A; 75V/0.5A		
Conductor Ratings and Cross-Sectional Area for Remote Contact Signal Terminals		60/75°C Max. 1.5mm ² /14AWG Solid/Flexible		
Ordering Information		Order from Catalog Numbers Above		

* See Bussmann SPD Limited Warranty Statement (3A1502) for details at www.cooperbussmann.com/surge.

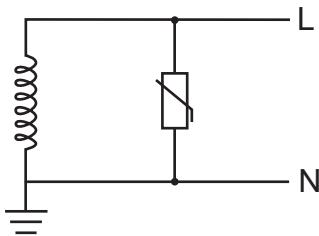

120, 240, 347Vac 2 Wire Systems

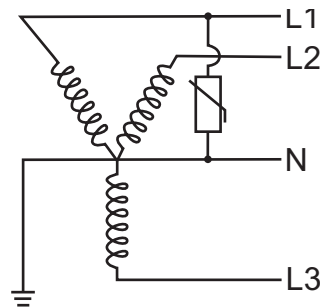

120, 277, 347Vac 2 Wire Wye Systems

Part Numbers for all systems BSPM1120S2G, BSPM1240S2G, BSPM1347S2G

UL DIN-Rail SPD - High SCCR

BSPM_ _ _ S3G

Dimensions - mm



easyID™
Visual Status Indication



Remote Signal
Contact Available

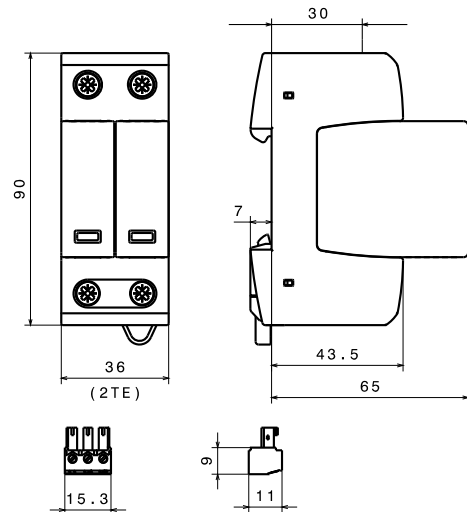

Shown with optional remote contact signaling

Description

The Bussmann 2-pole UL modular surge arresters for 120/240, 120/208, 127/254, 240, 240/480, 277/480 and 480Vac (split-phase) systems feature local, *easyID™* visual indication and optional remote contact signaling. The unique module locking system fixes the protection module to the base part. Modules can be easily replaced without tools by simply depressing the release buttons. Integrated mechanical coding between the base and protection module ensures against installing an incorrect replacement module.

Features

- Surge arrester according to UL 1449 3rd Edition, Type 2 Component Assembly helps meet UL 508A requirements
- Heavy-duty zinc oxide varistors for high discharge capacity
- "Thermo Dynamic Control" SPD monitoring device ensures high reliability against surge events
- Module locking system with module release button make module replacement easy without tools
- Up to 200kA Short-Circuit Current Rating (SCCR) make higher *assembly* SCCR ratings possible
- Optional remote signaling of all protection modules make status monitoring easy and accurate in any monitoring scheme
- No upstream overcurrent protection necessary to make installation easier and more economical
- Vibration and shock tested according to EN 60068-2 to withstand harsh environments

Optional Remote Signaling Contact

The remote signaling contact versions have a floating changeover contact for use as a break or make contact for easy adoption in any monitoring application.

Circuit Diagram

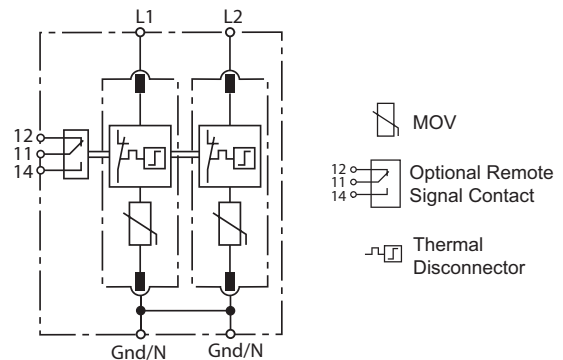

BSPM2240S3G, BSPM2480S3G*

Shown with optional remote contact signaling

*For remote signaling contact, add "R" suffix to the part number, e.g., BSPM2480S3GR

Data Sheet: 2150

UL DIN-Rail SPD - High SCCR

ORDERING INFORMATION		
Nominal System Voltage		120/240, 240Vac
Max. Continuous Operating Voltage MCOV [L-G/L-L]		275/550Vac
Catalog Numbers:	Without Remote Signaling	BSPM2240S3G
	With Remote Signaling	BSPM2240S3GR
Replacement Module	MOV Technology	BPM275UL
		BPM385UL
SPECIFICATIONS		
Rated Voltage		120-127Vac 240-254Vac 240Vac
Voltage Protection Rating V_{PR} [L-G/L-L]		1kV/1.8kV
Nominal Discharge Current I_n (kA)		20kA
Max. Discharge Current I_{max} (kA)		40kA
Response Time t_A		≤25 ns
SCCR		200kA
Frequency		50/60Hz
Number of Poles		2
Number of Wires/Connection Points		2 Wires or 3 Wires / 3 Connection Points
Operating State/Fault Indication		Green (good) / Red (replace)
Cross-Sectional Area (min.)		14AWG - Cu Stranded, Solid or Fine
Cross-Sectional Area (max.)		2AWG - Cu Solid or Stranded, 4AWG - Cu Fine
Terminal Torque		45 lb-in
For Mounting On		35mm DIN-Rail per EN 60715
Enclosure Material		Thermoplastic, UL 94V0
Degree of Protection		IP20 (finger-safe)
Location Category		Indoor
Capacity		2 mods, DIN 43880
Application		UL Type 2 Component Assembly
Standard		UL 1449, 3 rd Edition
Agency Information		cURus, CSA, RoHS Compliant
Product Warranty		Five Years*
REMOTE CONTACT SIGNALING		
Remote Contact Signaling Type		Changeover Contact
AC Switching Capacity (Volts/Amps)		250V/0.5A
DC Switching Capacity (Volts/Amps)		250V/0.1A; 125V/0.2A; 75V/0.5A
Conductor Ratings and Cross-Sectional Area for Remote Contact Signal Terminals		60/75°C Max. 1.5mm ² /14AWG Solid/Flexible
Ordering Information		Order from Catalog Numbers Above

* See Bussmann SPD Limited Warranty Statement (3A1502) for details at www.cooperbussmann.com/surge.

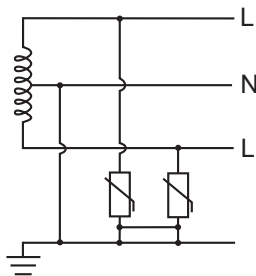

120/240V, 240/480Vac
Single Phase (Split) Center Tap
BSPM2240S3G, BSPM2480S3G

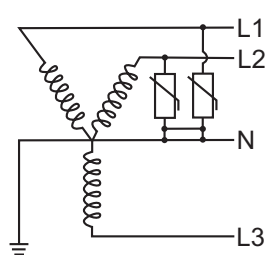

120/208V, 277/480Vac
3 Wire Wye System
BSPM2240S3G, BSPM2480S3G

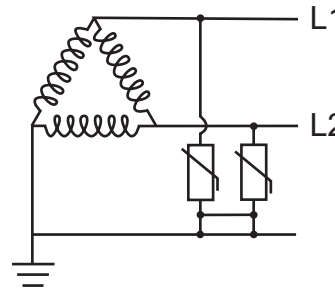

2 Wire Corner Grounded Delta

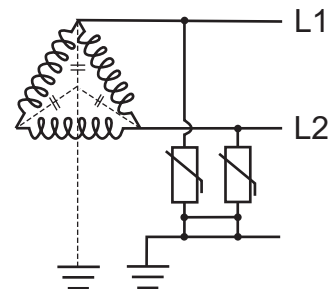

240, 480Vac
2 Wire Ungrounded Delta
BSPM2440S3G, BSPM2480S3G

UL DIN-Rail SPD - High SCCR

BSPM___ WYG, BSPM___ DLG

Dimensions - mm

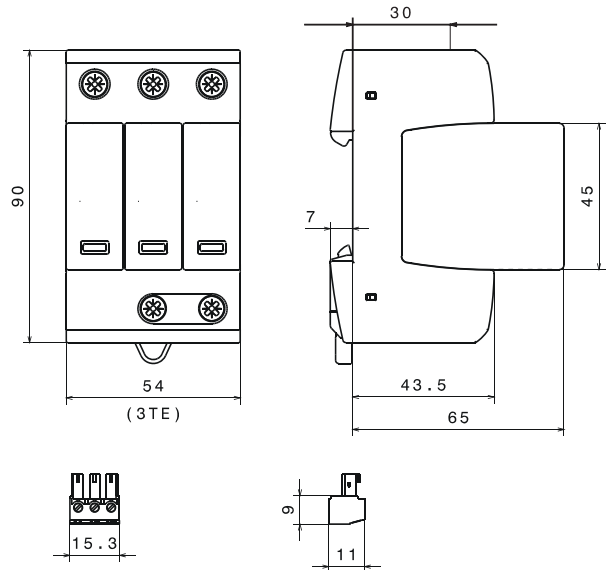

Shown with optional remote contact signaling

Description

The Bussmann 3-pole UL modular surge arresters for 240 and 480 3-phase Delta, and 120/208, 277/480 and 347/600Vac 3-phase Wye systems feature local, *easyID™* visual indication and optional remote contact signaling. The unique module locking system fixes the protection module to the base part. Modules can be easily replaced without tools by simply depressing the release buttons. Integrated mechanical coding between the base and protection module ensures against installing an incorrect replacement module.

Features

- Surge arrester according to UL 1449 3rd Edition, Type 2 Component Assembly helps meet UL 508A requirements
- Heavy-duty zinc oxide varistors for high discharge capacity
- "Thermo Dynamic Control" SPD monitoring device ensures high reliability against surge events
- Module locking system with module release button make module replacement easy without tools
- Up to 200kA Short-Circuit Current Rating (SCCR) make higher *assembly* SCCR ratings possible
- Optional remote signaling of all protection modules make status monitoring easy and accurate in any monitoring scheme
- No upstream overcurrent protection necessary to make installation easier and more economical
- Vibration and shock tested according to EN 60068-2 to withstand harsh environments

Optional Remote Signaling Contact

The remote signaling contact versions have a floating changeover contact for use as a break or make contact, according to circuit concept.

Circuit Diagrams

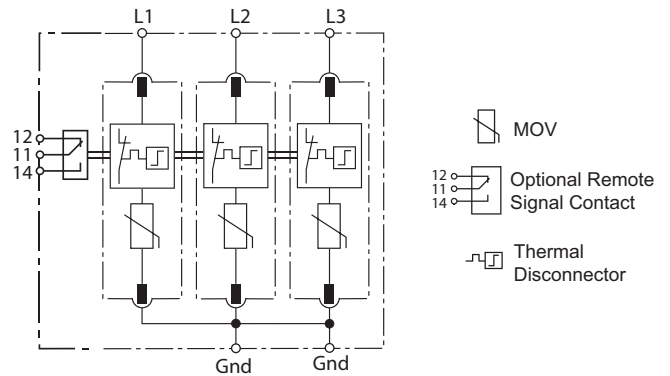

BSPM3208WYG, BSPM3480WYG), BSPM3600WYG, BSPM3240DLG, BSPM3480DLG*

Shown with optional remote contact signaling

*For remote signaling contact, add "R" suffix to the part number, E.g., BSPM3480DLGR

UL DIN-Rail SPD - High SCCR

ORDERING INFORMATION						
Nominal System Voltage	120/208Vac	240Vac	277/480Vac	480Vac	347/600Vac	
Max. Continuous Operating AC Voltage MCOV [L-G/L-L]	275/550Vac	275/550Vac	385/770Vac	600/1200Vac	600/1200Vac	
Catalog Numbers:	Without Remote Signaling	BSPM3208WYG	BSPM3240DLG	BSPM3480WYG	BSPM3480DLG	BSPM3600WYG
	With Remote Signaling	BSPM3208WYGR	BSPM3240DLGR	BSPM3480WYGR	BSPM3480DLGR	BSPM3600WYGR
Replacement Module	MOV Technology	BPM275UL	BPM275UL	BPM385UL	BPM600UL	BPM600UL
SPECIFICATIONS						
Rated Voltage	120-127Vac, 208-220Vac	240Vac	277/480Vac	480Vac	347/600Vac	
Voltage Protection Rating V_{PR} [L-G/L-L]	1kV/1.8kV	1kV/1.8kV	1.5kV/2.5kV	2kV/4kV	2kV/4kV	
SCCR	200kA	200kA	200kA	125kA	125kA	
Nominal Discharge Current I_n (kA)				20kA		
Max. Discharge Current I_{max} (kA)				40kA		
Response Time t_A				≤ 25 ns		
Frequency				50/60Hz		
Number of Poles				3		
Number of Wires/Connection Points				3 Wires / 4 Connection Points		
Operating State/Fault Indication				Green (good) / Red (replace)		
Cross-Sectional Area (min.)				14AWG - Cu Stranded, Solid or Fine		
Cross-Sectional Area (max.)				2AWG - Cu Solid or Stranded, 4AWG - Cu Fine		
Terminal Torque				45 lb-in		
For Mounting On				35mm DIN-Rail per to EN 60715		
Enclosure Material				Thermoplastic, UL 94V0		
Degree of Protection				IP20 (finger-safe)		
Location Category				Indoor		
Capacity				3 Mods, DIN 43880		
Application				UL Type 2 Component Assembly		
Standard				UL 1449, 3 rd Edition		
Agency Information				cURus, CSA, RoHS Compliant		
Product Warranty				Five Years*		
REMOTE CONTACT SIGNALING						
Remote Contact Signaling Type				Changeover Contact		
AC Switching Capacity (Volts/Amps)				250V/0.5A		
DC Switching Capacity (Volts/Amps)				250V/0.1A; 125V/0.2A; 75V/0.5A		
Conductor Ratings and Cross-Sectional Area for Remote Contact Signal Terminals				60/75°C Max. 1.5mm ² /14AWG Solid/Flexible		
Ordering Information				Order from Catalog Numbers Above		

* See Bussmann SPD Limited Warranty Statement (3A1502) for details at www.cooperbussmann.com/surge.

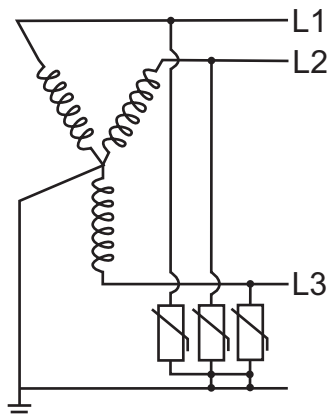

208, 480, 600Vac

Wye 3-Phase, 3 Wire + Ground

BSPM3208WYG, BSPM3480WYG, BSPM3600WYG

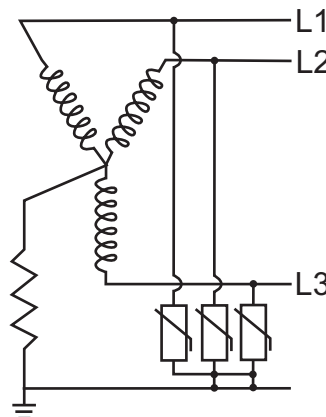

208V, 480V, 600Vac

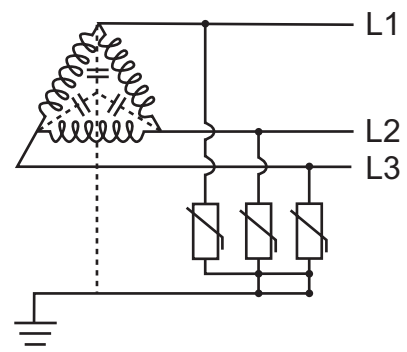

240, 480Vac

Delta 3-Phase, 3 Wire + Ground
BSPM3240DLG, BSPM3480DLG

UL DIN-Rail SPD - High SCCR

BSPM_ _ _ WYNG, BSPM_ _ _ HLG

Dimensions - mm

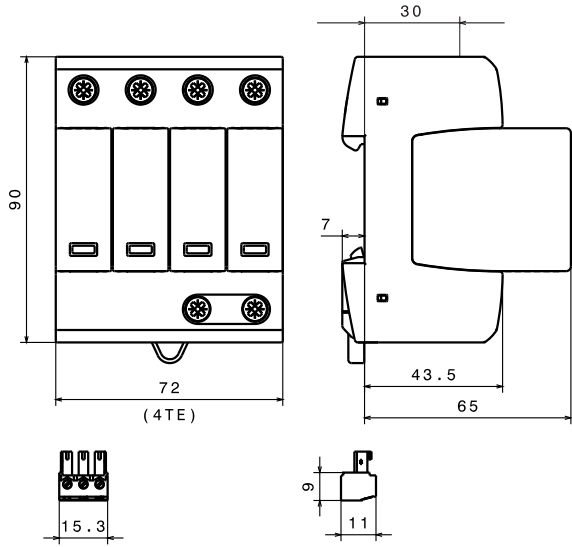

Shown with optional remote contact signaling

Description

The Bussmann 4-pole UL modular surge arresters for 120/240, 240/480Vac 3-phase Highleg Delta and 120/208, 127/220, 277/480 and 347/600Vac 3-phase 4 wire Wye systems feature local, *easyID*™ visual indication and optional remote contact signaling. The unique module locking system fixes the protection module to the base part. Modules can be easily replaced without tools by simply depressing the release buttons. Integrated mechanical coding between the base and protection module ensures against installing an incorrect replacement module.

Features

- Surge arrester according to UL 1449 3rd Edition, Type 2 Component Assembly helps meet UL 508A requirements
- Heavy-duty zinc oxide varistors for high discharge capacity
- "Thermo Dynamic Control" SPD monitoring device ensures high reliability against surge events
- Module locking system with module release button make module replacement easy without tools
- Up to 200kA Short-Circuit Current Rating (SCCR) make higher *assembly* SCCR ratings possible
- Optional remote signaling of all protection modules make status monitoring easy and accurate in any monitoring scheme
- No upstream overcurrent protection necessary to make installation easier and more economical
- Vibration and shock tested according to EN 60068-2 to withstand harsh environments

Optional Remote Signaling Contact

The remote signaling contact versions have a floating changeover contact for use as a break or make contact for easy adoption in any monitoring application.

Data Sheet: 2152

Circuit Diagram

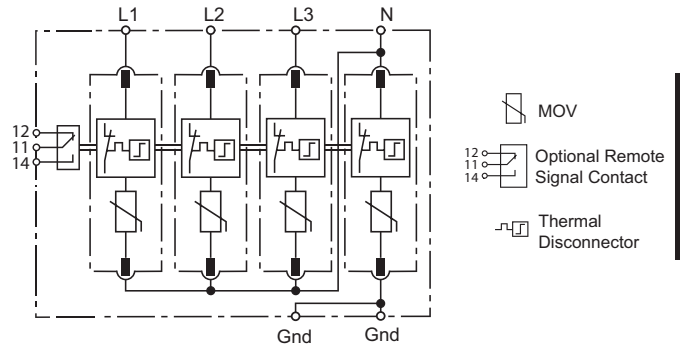

BSPM4208WYNG, BSPM4480WYNG, BSPM4600WYNG, BSPM4240HLG, BSPM4480HLG*

Shown with optional remote contact signaling

*For remote signaling contact, add "R" suffix to the part number, E.g., BSPM4480HLGR

Surge Protection Devices

UL DIN-Rail SPD - High SCCR

ORDERING INFORMATION						
Nominal System Voltage		120/208Vac, 127/220Vac	120/240Vac	240/480Vac	277/480Vac	347/600Vac
Max. continuous operating AC voltage MCOV	[L-N]/[L-G]	275/550Vac	275/550Vac	385/770Vac	385/660Vac	600/875Vac
	[N-G]/[L-L]	275/550Vac	275/550Vac	385/770Vac	275/770Vac	275/1200Vac
	[H-N]/[H-G]	--	275/550Vac	600/985Vac	--	--
	[H-L]	--	550Vac	985Vac	--	--
Catalog Numbers:	Without Remote Signaling	BSPM4208WYNG	BSPM4240HLG	BSPM4480HLG	BSPM4480WYNG	BSPM4600WYNG
	With Remote Signaling	BSPM4208WYNGR	BSPM4240HLGR	BSPM4480HLGR	BSPM4480WYNGR	BSPM4600WYNGR
Replacement Modules	Module Positions	L1 or L3	BPM275UL	BPM275UL	BPM385UL	BPM385UL
MOV Technology		L2	BPM275UL	BPM275UL	BPM600UL	BPM385UL
Four (4) Total Required		N	BPM275UL	BPM275UL	BPM385UL	BPM275UL
SPECIFICATIONS						
Rated Voltage		120/208Vac, 127/220Vac	120/240Vac	240/480Vac	277/480Vac	347/600Vac
Voltage Protection Rating V_{PR}	[L-N/L-G]	1kV/1.8kV	1kV/1.8kV	1.5kV/2.5kV	1.5kV/2.5kV	2kV/3kV
	[N-G/L-L]	1kV/1.8kV	1kV/1.8kV	1.5kV/2.5kV	1kV/2.5kV	1kV/4kV
	[H-N/H-G]	--	1kV/1.8kV	2kV/3kV	--	--
	[H-L]	--	1.8kV	3kV	--	--
SCCR		200kA	200kA	125kA	200kA	125kA
Nominal Discharge Current I_n (kA)				20kA		
Max. Discharge Current I_{max} (kA)				40kA		
Response Time t_A				≤ 25 ns		
Frequency				50/60Hz		
Number of Poles				4		
Number of Wires/Connection Points				4 Wires / 5 Connection Points		
Operating State/Fault Indication				Green (good) / Red (replace)		
Cross-Sectional Area (min.)				14AWG - Cu Stranded, Solid or Fine		
Cross-Sectional Area (max.)				2AWG - Cu Solid or Stranded, 4AWG - Cu Fine		
Terminal Torque				45 lb-in		
For Mounting On				35mm DIN-Rail per to EN 60715		
Enclosure Material				Thermoplastic, UL 94V0		
Degree of Protection				IP20 (finger-safe)		
Location Category				Indoor		
Capacity				4 Mods, DIN 43880		
Application				UL Type 2 Component Assembly		
Standard				UL 1449, 3 rd edition		
Agency Information				cURus, CSA, RoHS Compliant		
Product Warranty				Five Years*		
REMOTE CONTACT SIGNALING						
Remote Contact Signaling Type				Changeover Contact		
AC Switching Capacity (Volts/Amps)				250V/0.5A		
DC Switching Capacity (Volts/Amps)				250V/0.1A; 125V/0.2A; 75V/0.5A		
Conductor Ratings and Cross-Sectional Area for Remote Contact Signal Terminals				60/75°C Max. 1.5mm ² /14AWG Solid/Flexible		
Ordering Information				Order from Catalog Numbers Above		

* See Bussmann SPD Limited Warranty Statement (3A1502) for details at www.cooperbussmann.com/surge.

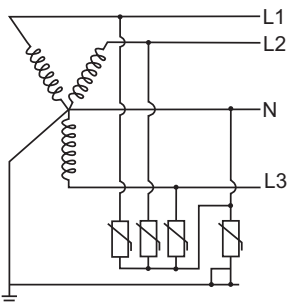

120/208V, 127/220V, 277/480V, 347/600Vac
Wye 3-Phase, 4 Wire + Ground
**BSPM4208WYNG, BSPM4480WYNG,
BSPM4600WYNG**

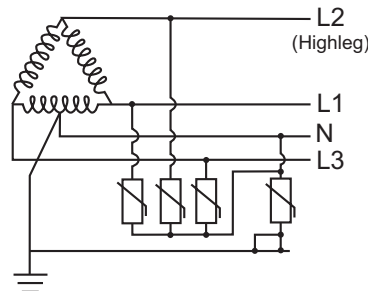

120/240V, 240/480Vac
Highleg Delta, 3-Phase, 4 Wire + Ground
BSPM4240HLG, BSPM4480HLG

Data Sheet: 2152

UL DIN-Rail SPD - Low Voltage AC/DC Power

BSPM1A_ _ _ LV



easyID™

Visual Status Indication



Remote Signal Contact Available



Dimensions - mm

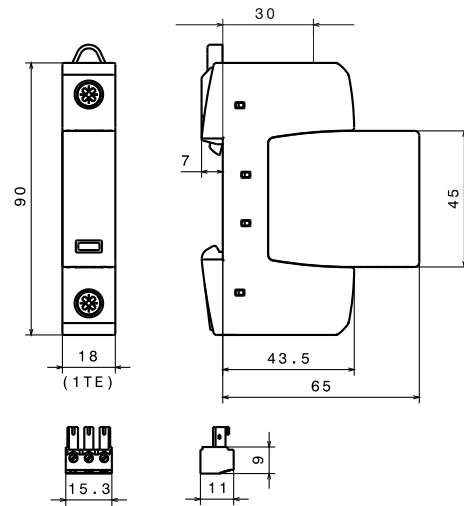

Shown with optional remote contact signaling

Description

The Bussmann UL Type 2 48Vac/60Vdc, 75Vac/100Vdc, 120Vac/200Vdc, 275Vac/350Vdc, 320Vac/420Vdc, 385Vac/500Vdc, 440Vac/585Vdc and 600Vac/dc single pole, modular surge arresters feature local, easyID™ visual indication and optional remote contact signaling. The unique module locking system fixes the protection module to the base part. Modules can be easily replaced without tools by simply depressing the release buttons. Integrated mechanical coding between the base and protection module ensures against installing an incorrect replacement module.

LV Power System Arresters

The features of these single-pole devices are for use as a single device or in combination with other devices for AC and DC voltage systems.

- Surge arrester according to UL 1449 3rd Edition, Type 2 Component Assembly helps meet UL 508A requirements*
- Proven MOV technology for reliable surge protection
- "Thermo Dynamic Control" SPD monitoring device ensures high reliability against surge events
- Module locking system with module release button make module replacement easy without tools
- Optional remote signaling of all protection modules make status monitoring easy and accurate in any monitoring scheme
- No upstream overcurrent protection necessary to make installation easier and more economical
- Vibration and shock tested according to EN 60068-2 to withstand harsh environments

Optional Remote Signaling Contact

The remote signaling contact versions have a floating changeover contact for use as a break or make contact for easy adoption in any monitoring application.

* Except as noted in data sheets.

Module Circuit Diagrams - Shown with optional remote contact signaling

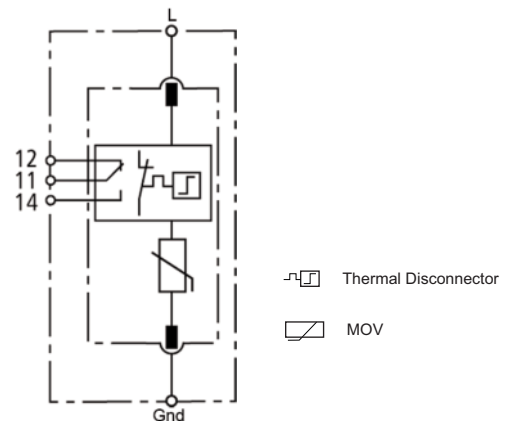

**BSPM1A48D60LV, BSPM1A75D100LV,
BSPM1A150D200LV,
BSPM1A275D350LV, BSPM1A320D420LV,
BSPM1A385D500LV, BSPM1A440D585LV,
BSPM1A600D600LV***

Shown with optional remote contact signaling

*For remote signaling contact, add "R" suffix to the part number, E.g., BSPM1A150D200LVR

Surge Protection Devices

UL DIN-Rail SPD - Low Voltage AC/DC Power

Ordering Information - 48Vac/60Vdc to 275Vac/350Vdc					
System Voltage		48Vac/60Vdc	75Vac/100Vdc	120Vac/200Vdc	275Vac/350Vdc
Catalog Numbers: (Base + Modules)	Without Remote Signaling	BSPM1A48D60LV	BSPM1A75D100LV	BSPM1A150D200LV	BSPM1A275D350LV
	With Remote Signaling	BSPM1A48D60LVR	BSPM1A75D100LVR	BSPM1A150D200LVR	BSPM1A275D350LVR
Replacement Modules		BPMA48D60LV	BPMA75D100LV	BPMA150D200LV	BPMA275D350LV
Specifications					
Max. continuous operating AC voltage [V _C]		48Vac	75Vac	150Vac	275Vac
Max. continuous operating DC voltage [V _C]		60Vdc	100Vdc	200Vdc	350Vdc
Nominal discharge current (8/20 μs) [I _n]		10kA	10kA	15kA	20kA
Max. discharge current (8/20 μs) [I _{max}]		25kA	40kA	40kA	40kA
Voltage protection level [V _{PR}]		≤ 0.3 kV	≤ 0.4kV	≤ 0.7kV	≤ 1.25kV
Voltage protection level at 5 kA [V _{PR}]		≤ 0.25kV	≤ 0.35kV	≤ 0.55kV	≤ 1kV
Temporary overvoltage (TOV)		70V / 5 sec.	90V / 5 sec.	175V / 5 sec.	335V / 5 sec
Agency Information*		--	UL / cUL, CSA, KEMA	UL / cUL, CSA, KEMA	UL / cUL, CSA, KEMA

Ordering Information - 320Vac/420Vdc to 600Vac/dc					
System Voltage		320Vac/420Vdc	385Vac/500Vdc	440Vac/585Vdc	600Vac/600Vdc
Catalog Numbers: (Base + Modules)	Without Remote Signaling	BSPM1A320D420LV	BSPM1A385D500LV	BSPM1A440D585LV	BSPM1A600D600LV
	With Remote Signaling	BSPM1A320D420LVR	BSPM1A385D500LVR	BSPM1A440D585LVR	BSPM1A600D600LVR
Replacement Modules		BPMA320D420LV	BPMA385D500LV	BPMA440D585LV	BPMA600D600LV
Specifications					
Max. continuous operating AC voltage [V _C]		320Vac	385Vac	440Vac	600Vac
Max. continuous operating DC voltage [V _C]		420Vdc	500Vdc	585Vdc	600Vdc
Nominal discharge current (8/20 μs) [I _n]		20kA	20kA	20kA	15kA
Max. discharge current (8/20 μs) [I _{max}]		40kA	40kA	40kA	30kA
Voltage protection level [V _{PR}]		≤ 1.5kV	≤ 1.75kV	≤ 2kV	≤ 2.5kV
Voltage protection level at 5 kA [V _{PR}]		≤ 1.2kV	≤ 1.35kV	≤ 1.7kV	≤ 2kV
Temporary overvoltage (TOV)		335V / 5 sec.	385V / 5 sec.	580V / 5 sec.	600V / 5 sec.
Agency Information*		UL / cUL, CSA, KEMA	UL / cUL, CSA, KEMA	UL / cUL, CSA, KEMA	UL / cUL, CSA, KEMA

Ordering Information - All Models	
SPD according to EN 61643-11	Type 2
SPD according to IEC 61643-1	Class II
Response time [t _A]	≤ 25 ns
TOV characteristics	Withstand
Operating temperature range [T _U]	-40°C to +80°C
Operating state/fault indication	Green (good) / Red (replace)
Number of ports	1
Cross-sectional area (min.)	1.5mm ² /14AWG solid/flexible
Cross-sectional area (max.)	35mm ² /1AWG stranded/25mm ² /2AWG flexible
For mounting on	35mm DIN-Rail per EN 60715
Enclosure material	Thermoplastic, UL 94V0
Location category	Indoor
Degree of protection	IP20
Capacity	1 Mod., DIN 43880
Product Warranty	Five Years**
Remote Contact Signaling	
Remote Contact Signaling Type	Changeover Contact
AC Switching Capacity (Volts/Amps)	250V/0.5A
DC Switching Capacity (Volts/Amps)	250V/0.1A; 125V/0.2A; 75V/0.5A
Conductor Ratings and Cross-Sectional Area for Remote Contact Signal Terminals	60/75°C Max. 1.5mm ² /14AWG Solid/Flexible
Ordering Information	Order from Catalog Numbers Above

* Standards information not applicable to DC ratings.

** See Bussmann SPD Limited Warranty Statement (3A1502) for details at www.cooperbussmann.com/surge.

UL DIN-Rail SPD - Low Voltage AC/DC Control

BSPH2A_ _ _ LV(R)



easyID™
Visual Status Indication



Remote Signal
Contact Available



Dimensions - mm

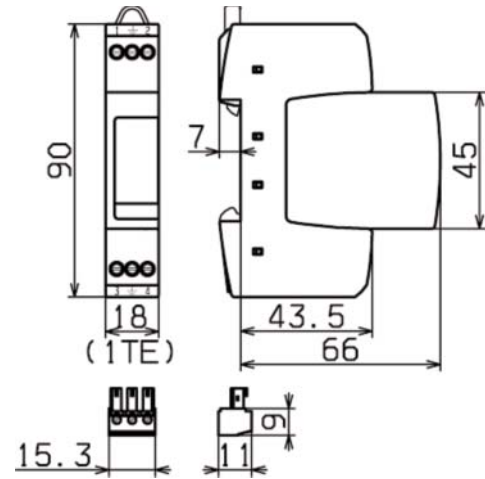

Shown with optional remote contact signaling

Specifications

Description

The Bussmann UL Type 3 24Vac/dc, 48Vac/dc, 60Vac/dc, 120Vac/dc and 230Vac/dc, two-pole, modular surge arresters feature local, *easyID™* visual indication and optional remote contact signaling. The unique module locking system fixes the protection module to the base part. Modules can be easily replaced without tools by simply depressing the release buttons. Integrated mechanical coding between the base and protection module ensures against installing an incorrect replacement module.

LV System Arresters

The features of these two-pole devices are for use in coordination with other upstream SPDs in UL 508A Applications*.

- Surge arrester according to UL 1449 3rd Edition, Type 3 Component Assembly helps meet UL 508A requirements
- Proven MOV and GDT hybrid technology for reliable surge protection
- "Thermo Dynamic Control" SPD monitoring device ensures high reliability against surge events
- Module locking system with module release button make module replacement easy without tools
- Optional remote signaling of all protection modules make status monitoring easy and accurate in any monitoring scheme
- No upstream overcurrent protection necessary to make installation easier and more economical
- Vibration and shock tested according to EN 60068-2 to withstand harsh environments

Optional Remote Signaling Contact

The remote signaling contact versions have a floating changeover contact for use as a break or make contact for easy adoption in any monitoring application.

* UL 1449 3rd Edition not applicable to DC voltages.

Module Circuit Diagrams

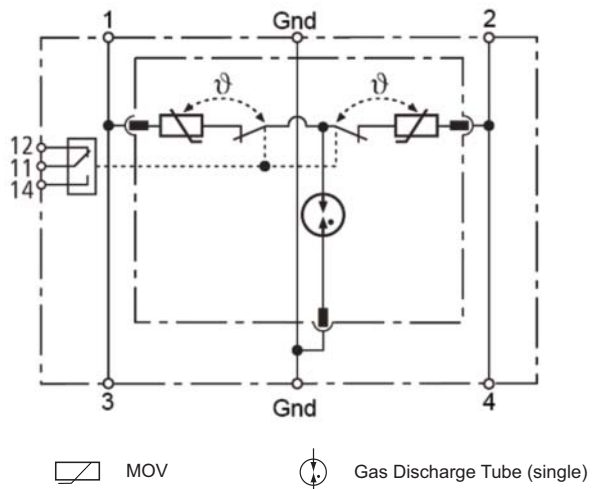

BPH2A24D24LV BPH2A48D48LV BPH2A60D60LV
BPH2A150D150LV BPH2A230D230LV

Shown with optional remote contact signaling

*For remote signaling contact, add "R" suffix to the part number, E.g., BSPH2A230D230LVR

Surge Protection
Devices

UL DIN-Rail SPD - Low Voltage AC/DC Power

Ordering Information						
System Voltage	24Vac/dc	48Vac/dc	60Vac/dc	120Vac/dc	230Vac/dc	
Max. Continuous operating AC voltage (MCOV) [V _C]	30Vac/dc	60Vac/dc	75Vac/dc	150Vac/dc	255Vac/dc	
Catalog Numbers: (Base + Modules)	Without Remote Signaling	BSPH2A24D24LV	BSPH2A48D48LV	BSPH2A60D60LV	BSPH2A150D150LV	BSPH2A230D230LV
	With Remote Signaling	BSPH2A24D24LVR	BSPH2A48D48LVR	BSPH2A60D60LVR	BSPH2A150D150LVR	BSPH2A230D230LVR
Replacement Modules	BPHA24D24LV	BPHA48D48LV	BPHA60D60LV	BPHA150D150LV	BPHA230D230LV	
Specifications						
Nominal AC voltage [V ₀]	24V	48V	60V	120V	230V	
Max. continuous operating AC voltage [V _C]	30V	60V	75V	150V	255V	
Max. continuous operating DC voltage [V _C]	30V	60V	75V	150V	255V	
Nominal load current AC [I _N]	25A	25A	25A	25A	25A	
Nominal discharge current (8/20 μs) [I _n]	1kA	1kA	2kA	2kA	3kA	
Total discharge current (8/20 μs) [L+N-Gnd] [I _{total}]	2kA	2kA	4kA	4kA	5kA	
Combined impulse [U _{OC}]	2kV	2kV	4kV	4kV	6kV	
Combined impulse [L+N-Gnd] [U _{OC} total]	4kV	4kV	8kV	8kV	10kV	
Voltage protection level [L-N] [V _{PR}]	≤ 180V	≤ 350V	≤ 400V	≤ 640V	≤ 1250V	
Voltage protection level [L/N-Gnd] [V _{PR}]	≤ 630V	≤ 730V	≤ 730V	≤ 800V	≤ 1500V	
Temporary overvoltage (TOV) [L-N]	--	--	--	--	335V / 5 sec.	
Temporary overvoltage (TOV) [L/N-Gnd]	--	--	--	--	400V / 5 sec.	
Temporary overvoltage (TOV) [L+N-Gnd]	--	--	--	--	1200V + V ₀ / 20	
TOV characteristics [L-N]	--	--	--	--	Withstand	
TOV characteristics [L/N-Gnd]	--	--	--	--	Withstand	
TOV characteristics [L+N-Gnd]	--	--	--	--	Failure	
SPD according to EN 61643-11	Type 3					
SPD according to IEC 61643-1	Class III					
Response time [L-N] [t _A]	≤ 25 ns					
Response time [L/N-Gnd] [t _A]	≤ 100 ns					
Operating temperature range [T _U]	-40°C to +80°C					
Operating state/fault indication	Green (good) / Red (replace)					
Number of ports	1					
Cross-sectional area (min.)	0.5mm ² /18AWG solid/flexible					
Cross-sectional area (max.)	4mm ² /10AWG solid/2.5mm ² /12AWG flexible					
For mounting on	35mm DIN rail per EN 60715					
Enclosure material	Thermoplastic, UL 94V0					
Location category	Indoor					
Degree of protection	IP20					
Capacity	1 Mod., DIN 43880					
Agency Information*	UL / cUL, CSA, KEMA					
Product Warranty	Five Years**					
Remote Contact Signaling						
Remote Contact Signaling Type	Changeover Contact					
AC Switching Capacity (Volts/Amps)	250V/0.5A					
DC Switching Capacity (Volts/Amps)	250V/0.1A; 125V/0.2A; 75V/0.5A					
Conductor Ratings and Cross-Sectional Area for Remote Contact Signal Terminals	60/75°C Max. 1.5mm ² /14AWG Solid/Flexible					
Ordering Information	Order from Catalog Numbers Above					

* Standards information not applicable to DC ratings.

** See Bussmann SPD Limited Warranty Statement (3A1502) for details at www.cooperbussmann.com/surge.

IEC Class I DIN-Rail SPD

BSPS ___ TN, BSPS ___ TT



easyID™
Visual Status Indication



Remote Signal Contact Available



Dimensions - mm

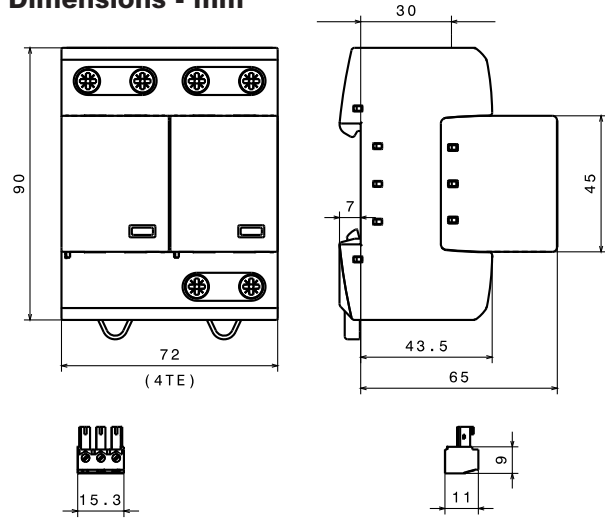

Shown with optional remote contact signaling

Description

The Bussmann IEC Class I 230V, two-pole, modular combined lightning, current and surge arresters feature local, *easyID™* visual indication and optional remote contact signaling. The unique module locking system fixes the protection module to the base part. Modules can be easily replaced without tools by simply depressing the release buttons. Integrated mechanical coding between the base and protection module ensures against installing an incorrect replacement module. 230V models are offered with MCOV rating of 255V.

TN System Arresters

The features of these two-pole devices are for use as a modular combined lightning and current arrester and surge arrester for use in single TN- systems ("2-0" circuit).



TT System Arrester

Provides a current arresting means for use in single TT- systems ("1-1" circuit).

Remote Signaling Contact

The three-terminal remote signaling contact versions have a floating changeover contact for use as a break or make contact, according to circuit concept.

Circuit Diagrams

-  Creepage Discharge Spark Gap
-  Spark Gap Trigger

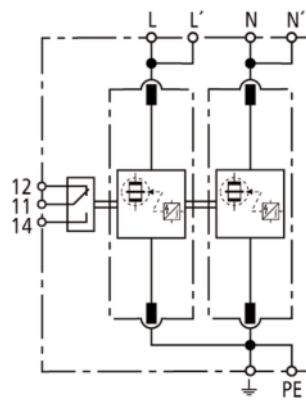

BSPS2255TN

Shown with optional remote contact signaling

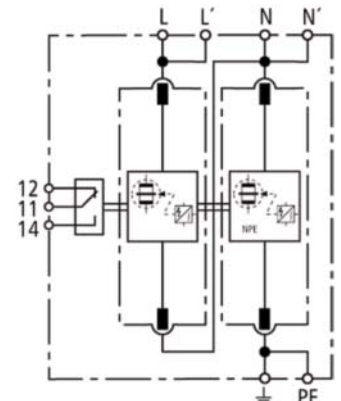

BSPS2255TT

Shown with optional remote contact signaling

*For remote signaling contact, add "R" suffix to the part number, E.g., BSPS2255TNR

Surge Protection Devices

IEC Class I DIN-Rail SPD

Ordering Information		
System Voltage/Poles	230V/2	230V/2
Max. Continuous operating AC voltage (MCOV) [U _C]	255V	255V
Catalog Numbers:	Without Remote Signaling	BSPS2255TN
	With Remote Signaling	BSPS2255TNR
Replacement Modules:	MOV technology	(2X) BPS255IEC
	Spark Gap technology	- - (1X) BPS50NPEIEC*
Specifications		
Specific energy [L+N-PE] [W/R]	625.00 kJ/ohms	- -
Lightning impulse current (10/350 μs) [L, N-PE] [I _{imp}]	25kA	25/50kA I _S [L-N]/[N-PE]
Specific energy [L,N-PE] [W/R]	156.25 kJ/ohms	156.25kJ/ohms/ 625.00 kJ/ohms
Voltage protection level [L-PE]/[N-PE] [U _P]	≤ 1.5 kV/≤ 1.5 kV	- -
Voltage protection level [L-N]/[N-PE] [U _P]	- -	≤ 1.5kV/≤ 1.5kV
Follow current extinguishing capability AC [I _{ff}]	50kA rms	- -
Follow current extinguishing capability [L-N]/[N-PE] [I _{ff}]	- -	50kA rms/100A rms
Temporary overvoltage (TOV) [N-PE] [U _T]	- -	1200V/200 ms
SPD according to EN 61643-11/... IEC 61643-1	Type 1/Class I	
Energy-coordinated protection effect with regard to the terminal equipment	Type 1 + Type 2	
Energy-coordinated protection effect with regard to the terminal equipment (≤ 5m)	Type 1 + Type 2 + Type 3	
Nominal AC voltage [U _N]	230V	
Lightning impulse current (10/350 μs) [L+N-PE] [I _{total}]	50kA	
Nominal discharge current (8/20 μs) [I _n]	25/50kA	
Follow current limitation/Selectivity	no tripping of a 20A gL/gG fuse up to 50kA rms (prosp.)	
Response time [t _A]	≤ 100 ns	
Max. Backup fuse (L) up to I _k ≤ 50kA rms	315A gL/gG	
Max. Backup fuse (L) for I _k > 50kA rms	200A gL/gG	
Max. Backup fuse (L-L)	125A gL/gG	
Temporary overvoltage (TOV) [L-N] [U _T]	440V/5 sec.	
TOV characteristics	withstand	
Operating temperature range (parallel connection) [T _{Up}]	-40°C to +80°C	
Operating temperature range (series connection) [T _{Us}]	-40°C to +60°C	
Operating temperature range [parallel]/[continuity] [T _U]	-40°C to +80°C/-40°C to +60°C	
Operating state/fault indication	green (good)/red (replace)	
Number of ports	1	
Cross-sectional area (L, L, N, N, PE, ⊥) [min.]	10mm ² solid/flexible	
Cross-sectional area (L, N, PE) [max.]	50mm ² /1AWG stranded-35mm ² /2AWG flexible	
Cross-sectional area (L, N, ⊥) [max.]	35mm ² /2AWG stranded-25mm ² /4AWG flexible	
For mounting on	35mm DIN Rail per EN 60715	
Enclosure material	Thermoplastic, UL 94V0	
Location category	Indoor	
Degree of protection	IP20	
Capacity	4 mods., DIN 43880	
Standards Information	KEMA	
Product Warranty	Five Years**	
Remote Contact Signaling		
Remote Contact Signaling Type	Changeover Contact	
AC Switching Capacity (Volts/Amps)	250V/0.1A	
DC Switching Capacity (Volts/Amps)	250V/0.1A; 125V/0.2A; 75V/0.5A	
Conductor Ratings and Cross-Sectional Area for Remote Contact Signal Terminals	60/75°C Max. 1.5mm ² /14AWG Solid/Flexible	
Ordering Information	Order from Catalog Numbers Above	

Recommended Bussmann NH DIN Size Back Up Fuses			
Size	NH Fuse Part Number	Size	NH Fuse Part Number
00	125NHG00B (max L-L)	02	125NHG02B (max L-L)
0	125NHG0B (max L-L)	02	200NHG02B (max L I _k >50kA)
01	125NHG01B (max L-L)	2	315NHG2B (max L ≤50kA)
1	200NHG1B (max L I _k >50kA)	03	315NHG03B (max L ≤50kA)

* N-PE Surge arrester for location between neutral conductor and protective conductor in TT systems.

** See Bussmann SPD Limited Warranty Statement (3A1502) for details at www.cooperbussmann.com/surge.

IEC Class I DIN-Rail SPD

BSPS_ _ _ TNC



Dimensions - mm

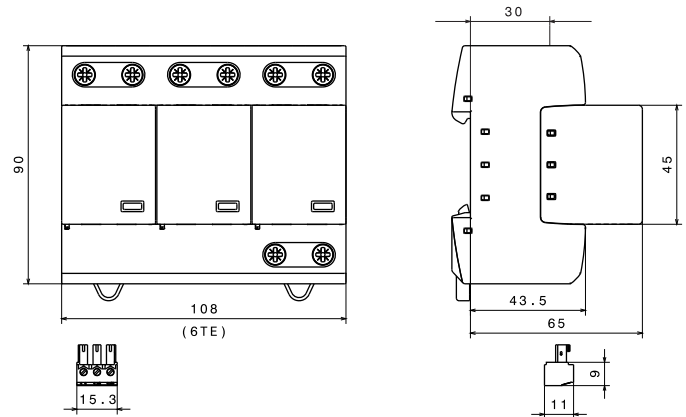

Shown with optional remote contact signaling

Circuit Diagrams

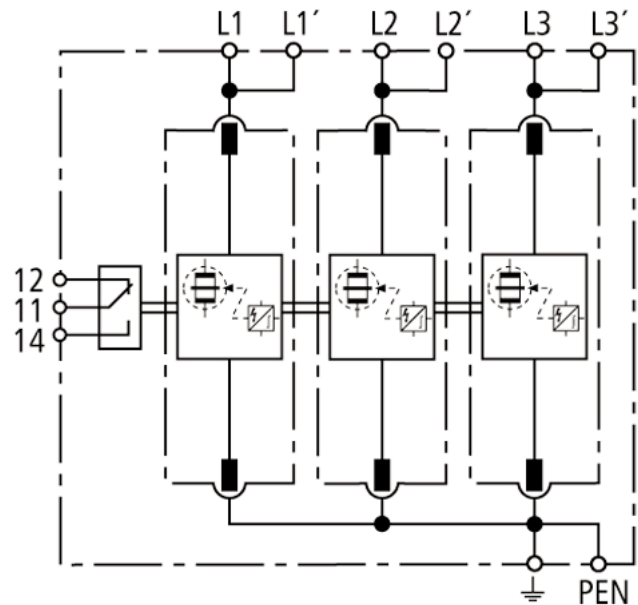

BSPS3255TNC

Shown with optional remote contact signaling

Description

The Bussmann IEC Class I 230V, three-pole, modular combined lightning, current and surge arresters feature local, *easyID*™ visual indication and optional remote contact signaling. The unique module locking system fixes the protection module to the base part. Modules can be easily replaced without tools by simply depressing the release buttons. Integrated mechanical coding between the base and protection module ensures against installing an incorrect replacement module.

230V models are offered with a MCOV rating of 255V.

TNC System Arrester

The features of these three-pole devices are for use in TN-C 230/400V systems (“3-0” circuit) against surges.

Remote Signaling Contact

The three-pole terminal remote signaling contact versions have a floating changeover contact for use as a break or make contact, according to circuit concept.

*For remote signaling contact, add “R” suffix to the part number, E.g., BSPS3255TNCR

Surge Protection Devices

IEC Class I DIN-Rail SPD

Ordering Information	
System Voltage/Poles	230/400V/3
Max. Continuous operating AC voltage (MCOV) [U _C]	255V
Catalog Numbers:	Without Remote Signaling BSPS3255TNC
	With Remote Signaling BSPS3255TNCR
Replacement Module	MOV technology BPS255IEC
Specifications	
SPD according to EN 61643-11/... IEC 61643-1	Type 1/Class I
Energy-coordinated protection effect with regard to the terminal equipment	Type 1 + Type 2
Energy-coordinated protection effect with regard to the terminal equipment (≤ 5m)	Type 1 + Type 2 + Type 3
Nominal AC voltage [U _N]	230/400V
Lightning impulse current (10/350 μs) [L1+L2+L3-PEN] [I _{total}]	75kA
Specific energy [L1+L2+L3-PEN] [W/R]	1.40 MJ/ohms
Lightning impulse current (10/350 μs) [L-PEN] [I _{imp}]	25kA
Specific energy [L-PEN] [W/R]	156.25kJ/ohms
Nominal discharge current (8/20 μs) [I _n]	25/75kA
Voltage protection level [U _p]	≤ 1.5kV
Follow current extinguishing capability AC [I _{fi}]	50kA rms
Follow current limitation/Selectivity	no tripping of a 20A gL/gG fuse up to 50kA rms (prosp.)
Response time [t _A]	≤ 100 ns
Max. Backup fuse (L) up to I _k = 50kA rms	315A gL/gG
Max. Backup fuse (L) for I _k > 50kA rms	200A gL/gG
Max. Backup fuse (L-L)	125A gL/gG
Temporary overvoltage (TOV) [U _T]	440V/5 sec.
TOV characteristics	withstand
Operating temperature range [parallel]/[continuity] [T _U]	-40°C to +80°C/-40°C to +60°C
Operating state/fault indication	green (good)/red (replace)
Number of ports	1
Cross-sectional area (L1, L1, L2, L2, L3, L3, PEN, $\frac{1}{2}$) [min.]	10mm ² solid/flexible
Cross-sectional area (L1, L2, L3, PEN) [max.]	50mm ² /1AWG stranded-35mm ² /2AWG flexible
Cross-sectional area (L1, L2, L3, $\frac{1}{2}$) [max.]	35mm ² /2AWG stranded-25mm ² /4AWG flexible
Mounting	35mm DIN rail per to EN 60715
Enclosure material	Thermoplastic, UL 94V0
Location category	Indoor
Degree of protection	IP20
Capacity	6 mods., DIN 43880
Standards Information	KEMA
Product Warranty	Five Years*
Remote Contact Signaling	
Remote Contact Signaling Type	Changeover Contact
AC Switching Capacity (Volts/Amps)	250V/0.1A
DC Switching Capacity (Volts/Amps)	250V/0.1A; 125V/0.2A; 75V/0.5A
Conductor Ratings and Cross-Sectional Area for Remote Contact Signal Terminals	60/75°C Max. 1.5mm ² /14AWG Solid/Flexible
Ordering Information	Order from Catalog Numbers Above

* See Bussmann SPD Limited Warranty Statement (3A1502) for details at www.cooperbussmann.com/surge.

Recommended Bussmann NH DIN Size Back Up Fuses			
Size	NH Fuse Part Number	Size	NH Fuse Part Number
00	125NHG00B (max L-L)	02	125NHG02B (max L-L)
0	125NHG0B (max L-L)	02	200NHG02B (max L I _k >50kA)
01	125NHG01B (max L-L)	2	315NHG2B (max L ≤50kA)
1	200NHG1B (max L I _k >50kA)	03	315NHG03B (max L ≤50kA)

IEC Class I DIN-Rail SPD

BSPS ___ TNS, BSBS ___ TT



easyID™
Visual Status Indication



Remote Signal
Contact Available



Dimensions - mm

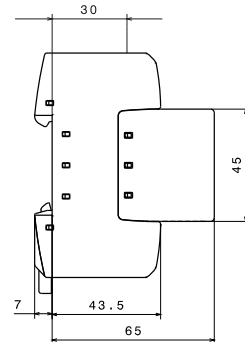
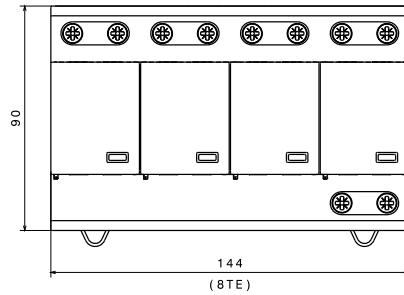

Shown with optional remote contact signaling

Circuit Diagrams



Creepage Discharge Spark Gap



Spark Gap Trigger

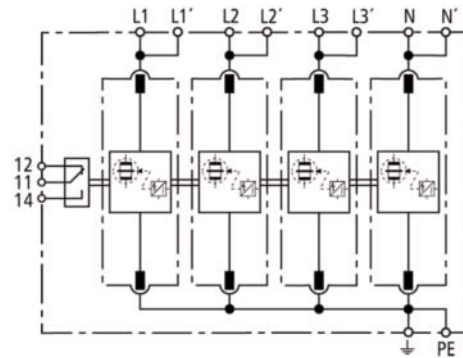

BSBS4255TNS

Shown with optional
remote contact signaling

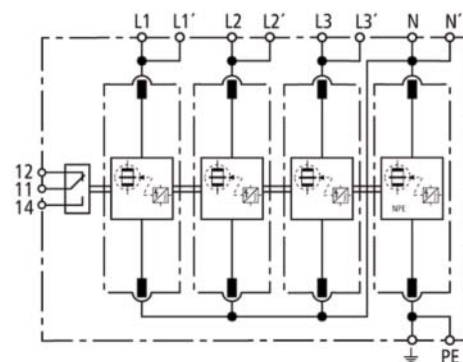

BSBS4255TT

Shown with optional
remote contact signaling

Description

The Bussmann IEC Class I 230V, four-pole, modular combined lightning, current and surge arresters feature local, *easyID™* visual indication and optional remote contact signaling. The unique module locking system fixes the protection module to the base part. Modules can be easily replaced without tools by simply depressing the release buttons. Integrated mechanical coding between the base and protection module ensures against installing an incorrect replacement module.

230V models are offered with MCOV ratings of 255V.

TNS System Arresters

The features of these four-pole devices are for use in TNS 230/400V systems ("4-0" circuit) against surges.

TT System Arrester

Provides a current arresting means between neutral conductor and protective conductor in TT 230/400V systems ("3+1" circuit) against surges.

Remote Signaling Contact

The three-pole terminal remote signaling contact versions have a floating changeover contact for use as a break or make contact, according to circuit concept.

IEC Class I DIN-Rail SPD

Ordering Information		
System Voltage/Poles		230/400V/4
Max. Continuous operating AC voltage (MCOV) [U _C]		255V
Catalog Numbers:	Without Remote Signaling	BSPS4255TNS
	With Remote Signaling	BSPS4255TNSR
Replacement Modules:	MOV technology	BPS255IEC
	Spark Gap technology	- -
		BPS100NPEIC*
Specifications		
SPD according to EN 61643-11/... IEC 61643-1		Type 1/Class I
Energy-coordinated protection effect with regard to the terminal equipment		Type 1 + Type 2
Energy-coordinated protection effect with regard to the terminal equipment (≤ 5m)		Type 1 + Type 2 + Type 3
Nominal AC voltage [U _N]		230/400V
Lightning impulse current (10/350 μs) [L1+L2+L3+N-PE] [I _{total}]		100kA
Specific energy [L1+L2+L3+N-PE] [W/R]		2.50MJ/ohms
Lightning impulse current (10/350 μs) [L, N-PE] [I _{imp}]		25kA
TNS system specific energy [L,N-PE] [W/R]		156.25kJ/ohms
TT system specific energy [L-N]/[N-PE] [W/R]		156.25kJ/ohms/2.50kJ/ohms
Nominal discharge current (8/20 μs) [I _n]		25/100kA
Voltage protection level [L-PE]/[N-PE] [U _p]		≤ 1.5kV/≤ 1.5kV
TNS system follow current extinguishing capability AC [I _{ff}]		50kA rms
TT system follow current extinguishing capability AC [I _{ff}]		50kA rms/100A rms
Follow current limitation/Selectivity		No tripping of a 20A gL/gG fuse up to 50kA rms (prosp.)
Response time [t _A]		≤ 100 ns
Max. Backup fuse (L) up to I _K ≤ 50kA rms		315A gL/gG
Max. Backup fuse (L) for I _K > 50kA rms		200A gL/gG
Max. Backup fuse (L-L)		125A gL/gG
Temporary overvoltage (TOV) [L-N] [U _T]		440V/5 sec.
Temporary overvoltage (TOV) [N-PE] [U _T]		1200V/200mS
TOV characteristics		Withstand
Operating temperature range [parallel]/[continuity] [T _{ij}]		-40°C to +80°C/-40°C to +60°C
Operating state/fault indication		green (good)/red (replace)
Number of ports		1
Cross-sectional area (L1, L1, L2, L2, L3, L3, N, N, PE, $\frac{\perp}{\perp}$) [min.]		10mm ² solid/flexible
Cross-sectional area (L1, L2, L3, N, PE) [max.]		50mm ² /1AWG stranded-35mm ² /2AWG flexible
Cross-sectional area (L1, L2, L3, N, $\frac{\perp}{\perp}$) [max.]		35mm ² /2AWG stranded-25mm ² /4AWG flexible
Mounting		35mm DIN Rail per EN 60715
Enclosure material		Thermoplastic, UL 94V0
Location category		Indoor
Degree of protection		IP20
Capacity		8 mods., DIN 43880
Agency Information		KEMA
Product Warranty		Five Years**
Remote Contact Signaling		
Remote Contact Signaling Type		Changeover Contact
AC Switching Capacity (Volts/Amps)		250V/0.1A
DC Switching Capacity (Volts/Amps)		250V/0.1A; 125V/0.2A; 75V/0.5A
Conductor Ratings and Cross-Sectional Area for Remote Contact Signal Terminals		60/75°C Max. 1.5mm ² /14AWG Solid/Flexible
Ordering Information		Order from Catalog Numbers Above

* N-PE Surge arrester for location between neutral conductor and protective conductor in TT systems.

** See Bussmann SPD Limited Warranty Statement (3A1502) for details at www.cooperbussmann.com/surge.

Recommended Bussmann NH DIN Size Back Up Fuses			
Size	NH Fuse Part Number	Size	NH Fuse Part Number
00	125NHG00B (max L-L)	02	125NHG02B (max L-L)
0	125NHG0B (max L-L)	02	200NHG02B (max L Ik >50kA)
01	125NHG01B (max L-L)	2	315NHG2B (max L ≤50kA)
1	200NHG1B (max L Ik >50kA)	03	315NHG03B (max L ≤50kA)

Data Sheet: 1165

IEC Class II DIN-Rail SPD

BSPM__ __TN, BSPG__ __NPE



easyID™
Visual Status Indication



Remote Signal Contact Available



Dimensions - mm

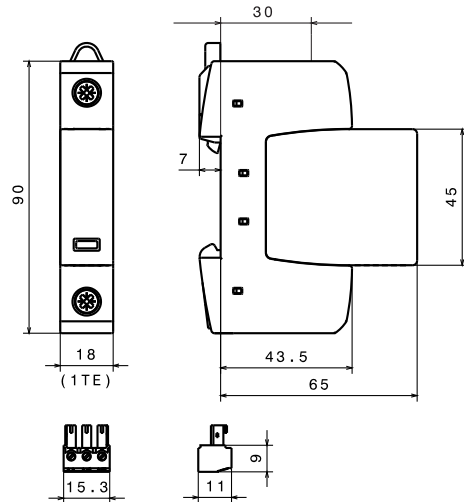

Shown with optional remote contact signaling

Description

The Bussmann IEC Class II 275, 320, 385, 440 and 600V, one-pole, modular surge arresters feature local, *easyID™* visual indication and optional remote contact signaling. The unique module locking system fixes the protection module to the base part. Modules can be easily replaced without tools by simply depressing the release buttons. Integrated mechanical coding between the base and protection module ensures against installing an incorrect replacement module. Class II single-pole surge arrester models are offered with MCOV ratings of 255, 275, 320, 385, 440 and 600V.

TN System Arresters

The features of these single-pole devices are for use as a single device or in combination with other devices.

TT System Arrester

Provides a current arresting means between neutral conductor and protective conductor in TT systems, this device helps ensure fulfilling the requirements for protection of personnel and equipment in “3+1” and “1+1” circuits.

Remote Signaling Contact

The three-pole terminal remote signaling contact versions have a floating changeover contact for use as a break or make contact, according to circuit concept.

Module Circuit Diagrams -

Shown with optional remote contact signaling

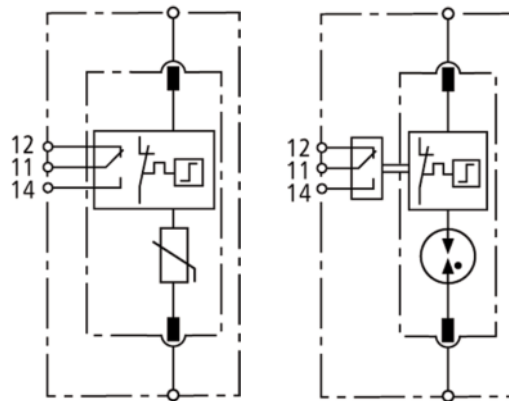

- MOV
- Thermal Disconnect
- Gas Discharge Tube (single)

BSPM1275TN
BSPM1320TN
BSPM1385TN
BSPM1440TN
BSPM1600TN

BSPG1255NPE(R)

*For remote signaling contact, add “R” suffix to the part number, E.g., BSPM1275TNR

IEC Class II DIN-Rail SPD

Ordering Information							
System Voltage/Poles	230V/1	230V/1	230V/1	400V/1	600V/1	230V/1*	
Max. Continuous operating AC voltage (MCOV) [U _C]	275V	320V	385V	440V	600V	255V	
Catalog Numbers:	Without Remote Signaling	BSPM1275TN	BSPM1320TN	BSPM1385TN	BSPM1440TN	BSPM1600TN	BSPG1255NPE
(Base + Modules)	With Remote Signaling	BSPM1275TNR	BSPM1320TNR	BSPM1385TNR	BSPM1440TNR	BSPM1600TNR	BSPG1255NPER
Replacement Modules		BPM275IEC	BPM320IEC	BPM385IEC	BPM440IEC	BPM600IEC	BPG255NPE
Specifications							
Line system type	TN / TT	TN / TT	TN / TT	TN	TN	TT	
Max. Continuous operating DC voltage [U _C]	350V	420V	500V	585V	600V	--	
Voltage protection level [U _p]	≤ 1.25kV	≤ 1.5kV	≤ 1.75kV	≤ 2kV	≤ 2.5kV	≤ 1.5kV	
Voltage protection level at 5kA [U _p]	≤ 1kV	≤ 1.2kV	≤ 1.35kV	≤ 1.7kV	≤ 2kV	--	
Max. mains-side overcurrent protection	125A gL/gG	125A gL/gG	125A gL/gG	125A gL/gG	100A gL-gG	--	
Short-circuit withstand capability for max. mains-side overcurrent protection	50kA _{Rms}	25kA _{Rms}	25kA _{Rms}	25kA _{Rms}	25kA rms	--	
Temporary overvoltage (TOV) [U _T]	335V/5 sec.	335V/5 sec.	385V/5 sec.	580V/5 sec.	600V/5 sec.	1200V/200 ms	
Response time [t _A]	≤ 25 ns	≤ 25 ns	≤ 25 ns	≤ 25 ns	≤ 25 ns	≤ 100 ns	
Follow current extinguishing capability [I _f]	--	--	--	--	--	100A _{Rms}	
Lightning impulse current (10/350 μs) [I _{imp}]	--	--	--	--	--	12kA	
Nominal discharge current (8/20 μs) [I _n]	20kA	20kA	20kA	20kA	15kA	20kA	
Max. Discharge current (8/20 μs) [I _{max}]	40kA	40kA	40kA	40kA	30kA	40kA	
Standards Information	KEMA	KEMA, CSA	KEMA, CSA	KEMA, CSA	KEMA, CSA	KEMA	
Capacity	1 mod., DIN 43880						
SPD according to EN 61643-11	Type 2						
SPD according to IEC 61643-1	Class II						
TOV characteristics	Withstand						
Operating temperature range [T _o]	-40°C to +80°C						
Operating state/fault indication	Green (good) / Red (replace)						
Number of ports	1						
Cross-sectional area (min.)	1.5mm ² /14AWG solid/flexible						
Cross-sectional area (max.)	35mm ² /2AWG stranded-25mm ² /4AWG flexible						
Mounting	35mm DIN Rail per EN 60715						
Enclosure material	Thermoplastic, UL 94V0						
Location category	Indoor						
Degree of protection	IP20						
Product Warranty	Five Years**						
Remote Contact Signaling							
Remote Contact Signaling Type	Changeover Contact						
AC Switching Capacity (Volts/Amps)	250V/0.1A						
DC Switching Capacity (Volts/Amps)	250V/0.1A; 125V/0.2A; 75V/0.5A						
Conductor Ratings and Cross-Sectional Area for Remote Contact Signal Terminals	60/75°C Max. 1.5mm ² /14AWG Solid/Flexible						
Ordering Information	Order from Catalog Numbers Above						

* N-PE Surge arrester for location between neutral conductor and protective conductor in TT systems.

** See Bussmann SPD Limited Warranty Statement (3A1502) for details at www.cooperbussmann.com/surge.

Recommended Bussmann Back Up Fuses		
DIN Fuse Size	TT / TN System NH Fuse Part Numbers	
	275, 320, 385, 440V	600V
00	125NHG00B	100NHG00B-690
0	125NHG0B	100NHG0B-690
01	125NHG01B	--
1	--	100NHG1B-690
02	125NHG02B	--
2	--	100NHG2B-690

IEC Class II DIN-Rail SPD

BSPM_ _ _ _ TN, BSPH_ _ _ _ TT



easyID™
Visual Status Indication



Remote Signal
Contact Available



Dimensions - mm

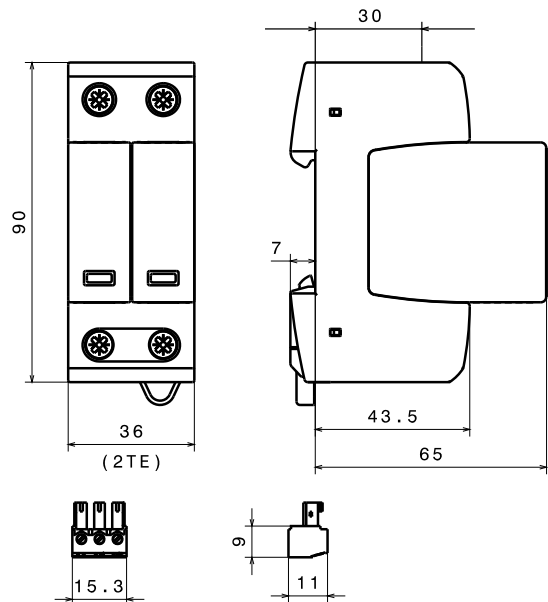

Shown with optional remote contact signaling

Description

The Bussmann IEC Class II 230V, two-pole, modular surge arresters feature local, *easyID™* visual indication and optional remote contact signaling. The unique module locking system fixes the protection module to the base part. Modules can be easily replaced without tools by simply depressing the release buttons. Integrated mechanical coding between the base and protection module ensures against installing an incorrect replacement module. 230V models are offered with MCOV ratings of 255 and 275V.

TN System Arresters

The features of these single-pole devices are for use in single-phase 230V TN systems ("2-0" circuit).

TT System Arrester

The features of these single-pole devices are for use in single-phase 230V TT and TNS systems ("1-1" circuit).

Remote Signaling Contact

The three-pole terminal remote signaling contact versions have a floating changeover contact for use as a break or make contact, according to circuit concept.

Circuit Diagrams

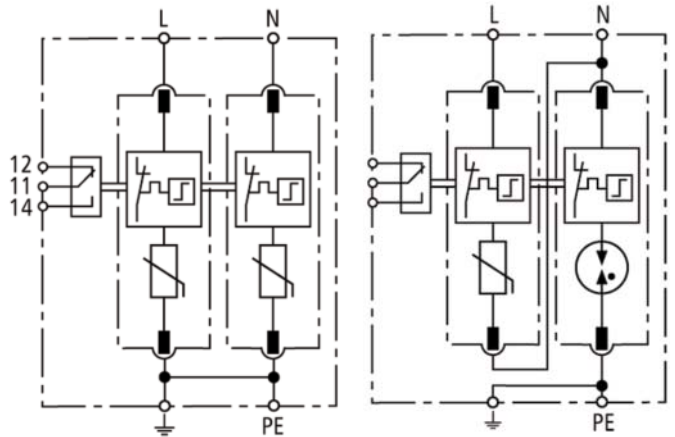
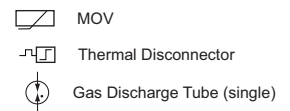

BSPM2275TN

Shown with optional remote contact signaling

BSPH2275TT

Shown with optional remote contact signaling

*For remote signaling contact, add "R" suffix to the part number, E.g., BSPM2275TNR

IEC Class II DIN-Rail SPD

Ordering Information		
System Voltage/Poles	230V/2	230V/2
Max. continuous operating AC voltage (MCOV) [U _C]	275V	--
Max. Continuous operating AC voltage (MCOV) [L-N] [U _C]	--	275V
Max. Continuous operating AC voltage (MCOV) [N-PE] [U _C]	--	255V
Catalog Numbers:	Without Remote Signaling	BSPM2275TN
	With Remote Signaling	BSPM2275TNR
Replacement Modules:	MOV Technology	BPM275IEC
	Spark Gap technology	--
		BSPH2275TT
		BSPH2275TTR
		BPM275IEC
		BPSNPEIEC*
Specifications		
Lightning impulse current (10/350 μs) [N-PE] [I _{imp}]	--	12kA
Voltage protection level [U _p]	≤ 1.25kV	--
Voltage protection level at 5kA [U _p]	≤ 1kV	--
Voltage protection level [L-N] [U _p]	--	≤ 1.25kV
Voltage protection level [L-N] at 5kA [U _p]	--	≤ 1kV
Voltage protection level [N-PE] [U _p]	--	≤ 1.5kV
Follow current extinguishing capability [N-PE] [I _{ff}]	--	100A rms
Response time [t _A]	≤ 25 ns	--
Response time [L-N] [t _A]	--	≤ 25 ns
Response time [N-PE] [t _A]	--	≤ 100 ns
Temporary overvoltage (TOV) [U _T]	335V/5 sec.	--
Temporary overvoltage (TOV) [L-N] [U _T]	--	335V/5 sec.
Temporary overvoltage (TOV) [N-PE] [U _T]	--	1200V/200 ms
SPD according to EN 61643-11		Type 2
SPD according to IEC 61643-1		Class II
Nominal discharge current (8/20 μs) [I _n]		20kA
Max. discharge current (8/20 μs) [I _{max}]		40kA
Max. mains-side overcurrent protection		125A gL/gG
Short-circuit withstand capability for max. mains-side overcurrent protection		50kA rms
Nominal AC voltage [U _N]		230V
TOV characteristics		withstand
Operating temperature range [T _{ij}]		-40°C to +80°C
Operating state/fault indication		green (good)/red (replace)
Number of ports		1
Cross-sectional area (min.)		1.5mm ² /14AWG solid/flexible
Cross-sectional area (max.)		35mm ² /2AWG stranded-25mm ² /4AWG flexible
Mounting		35mm DIN rail per EN 60715
Enclosure material		Thermoplastic, UL 94V0
Location category		Indoor
Degree of protection		IP20
Capacity		2 mods., DIN 43880
Standards Information		KEMA
Product Warranty		Five Years**
Remote Contact Signaling		
Remote Contact Signaling Type		Changeover Contact
AC Switching Capacity (Volts/Amps)		250V/0.1A
DC Switching Capacity (Volts/Amps)		250V/0.1A; 125V/0.2A; 75V/0.5A
Conductor Ratings and Cross-Sectional Area for Remote Contact Signal Terminals		60/75°C Max. 1.5mm ² /14AWG Solid/Flexible
Ordering Information		Order from Catalog Numbers Above

* N-PE Surge arrester for location between neutral conductor and protective conductor in TT systems.

** See Bussmann SPD Limited Warranty Statement (3A1502) for details at www.cooperbussmann.com/surge.

Recommended Bussmann Back Up Fuses	
DIN Fuse Size	NH Fuse Part Number
00	125NHG00B
0	125NHG0B
01	125NHG01B
02	125NHG02B

Data Sheet: 1167

IEC Class II DIN-Rail SPD

BSPM___TNC



easyID™
Visual Status Indication



Remote Signal Contact Available



Dimensions - mm

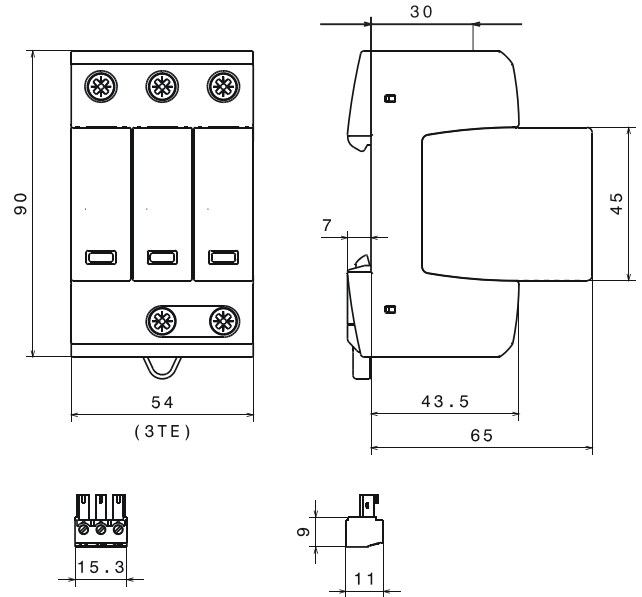

Shown with optional remote contact signaling

Description

The Bussmann IEC Class II 120/240V and 230/400V, three-pole, modular surge arresters feature local, *easyID™* visual indication and optional remote contact signaling. The unique module locking system fixes the protection module to the base part. Modules can be easily replaced without tools by simply depressing the release buttons. Integrated mechanical coding between the base and protection module ensures against installing an incorrect replacement module. 120V models are offered with a MCOV rating of 150V. 230V models are offered with a MCOV rating of 275 or 385V.

TNC System Arresters

The features of these three-pole devices are for use in TN-C 120/240V or 230/400V systems ("3-0" circuit) against surges.

Remote Signaling Contact

The three-pole terminal remote signaling contact versions have a floating changeover contact for use as a break or make contact, according to circuit concept.

Circuit Diagrams

MOV

Thermal Disconnector

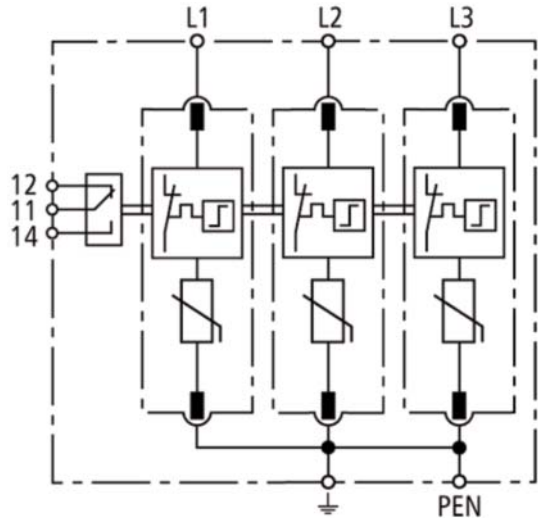

BSPM3150TNC, BSPM3275TNC, BSPM3385TNC

Shown with optional remote contact signaling

*For remote signaling contact, add "R" suffix to the part number, E.g., BSPM3150TNCR

Surge Protection Devices

IEC Class II DIN-Rail SPD

ORDERING INFORMATION			
System Voltage/Poles	120V/3	230V/3	230V/3
Max. Continuous operating AC voltage (MCOV) [U _C]	150V	275V	385V
Catalog Numbers:	Without Remote Signaling	BSPM3150TNC	BSPM3275TNC
	With Remote Signaling	BSPM3150TNCR	BSPM3275TNCR
Replacement Module	MOV technology	BPM150IEC	BPM275IEC
			BPM385IEC
SPECIFICATIONS			
Nominal AC voltage [U _N]	120/240V	230/400V	230/400V
Voltage protection level [U _p]	≤ 0.7kV	≤ 1.25kV	≤ 1.75kV
Voltage protection level at 5kA [U _p]	≤ 0.55kV	≤ 1kV	≤ 1.35kV
Short-circuit withstand capability for max. mains-side overcurrent protection	50kA _{rms}	50kA _{rms}	25kA _{rms}
Temporary overvoltage (TOV) [U _T]	175V/5 sec	335V/5 sec.	385V/5 sec
Nominal discharge current (8/20 μs) [I _n]	15kA	20kA	20kA
Max. Discharge current (8/20 μs) [I _{max}]		40kA	
SPD according to EN 61643-11		Type 2	
SPD according to IEC 61643-1		Class II	
Response time [t _A]		≤ 25 ns	
Max. mains-side overcurrent protection		125A gL/gG	
TOV characteristics		withstand	
Operating temperature range [T _U]		-40°C to +80°C	
Operating state/fault indication		Green (good)/Red (replace)	
Number of ports		1	
Cross-sectional area (min.)		1.5mm ² /14AWG solid/flexible	
Cross-sectional area (max.)		35mm ² /2AWG stranded-25mm ² /4AWG flexible	
Mounting		35mm DIN rail per EN 60715	
Enclosure material		Thermoplastic, UL 94V0	
Location category		Indoor	
Degree of protection		IP20	
Capacity		3 mods., DIN 43880	
Standards Information		KEMA	
Product Warranty		Five Years*	
REMOTE CONTACT SIGNALING			
Remote Contact Signaling Type		Changeover Contact	
AC Switching Capacity (Volts/Amps)		250V/0.1A	
DC Switching Capacity (Volts/Amps)		250V/0.1A; 125V/0.2A; 75V/0.5A	
Conductor Ratings and Cross-Sectional Area for Remote Contact Signal Terminals		60/75°C Max. 1.5mm ² /14AWG Solid/Flexible	
Ordering Information		Order from Catalog Numbers Above	

* See Bussmann SPD Limited Warranty Statement (3A1502) for details at www.cooperbussmann.com/surge.

Recommended Bussmann Back Up Fuses	
DIN Fuse Size	NH Fuse Part Number
00	125NHG00B
0	125NHG0B
01	125NHG01B
02	125NHG02B

IEC Class II DIN-Rail SPD

BSPH_TNS, BSPH_TT



easyID™

Visual Status Indication



Remote Signal Contact Available



Dimensions - mm

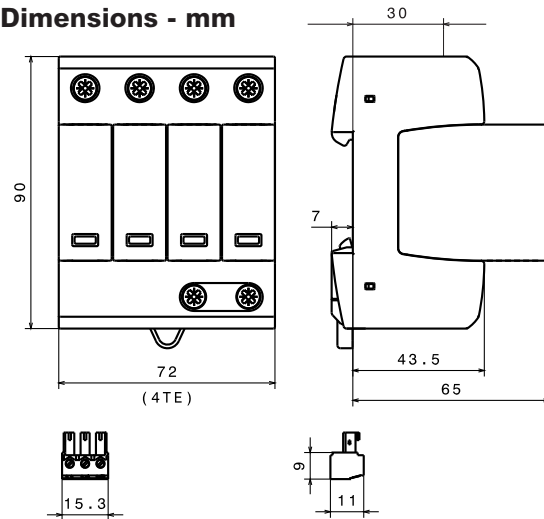

Shown with optional remote contact signaling

Circuit Diagrams

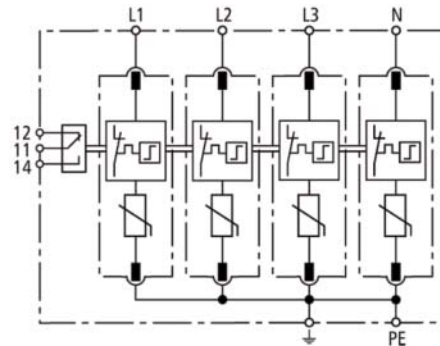
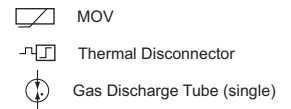

BSPM4275TNS

Shown with optional remote contact signaling

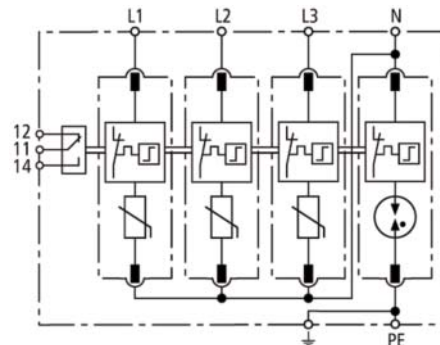

**BSPH4275TT, BSPH4320TT
BSPH4385TT**

Shown with optional remote contact signaling

Description

The Bussmann IEC Class II 230/400V, four-pole, modular surge arresters feature local, easyID™ visual indication and optional remote contact signaling. The unique module locking system fixes the protection module to the base part. Modules can be easily replaced without tools by simply depressing the release buttons. Integrated mechanical coding between the base and protection module ensures against installing an incorrect replacement module.

These 230V models are offered with MCOV ratings of 275, 320 or 385V.

TNS System Arrester

The features of these four-pole devices are for use in TNS 230/400V systems ("4-0" circuit) against surges.

TT System Arrester

The features of these four-pole devices are for use in TT and TN-S 230/400V systems ("3+1" circuit) against surges.

Remote Signaling Contact

The three-pole terminal remote signaling contact versions have a floating changeover contact for use as a break or make contact, according to circuit concept.

Data Sheet: 1169

*For remote signaling contact, add "R" suffix to the part number, E.g., BSPH4275TTR

IEC Class II DIN-Rail SPD

ORDERING INFORMATION					
System Voltage/Poles		230V/4	230V/4	230V/4	230V/4
Max. continuous operating AC voltage (MCOV) [U _C]		275V	--	--	--
Max. continuous operating AC voltage (MCOV) [L-N] [U _C]		--	275V	320V	385V
Max. continuous operating AC voltage [N-PE] [U _C]		--	255V	255V	255V
Catalog Numbers:	Without Remote Signaling	BSPM4275TNS	BSPH4275TT	BSPH4320TT	BSPH4385TT
	With Remote Signaling	BSPM4275TNSR	BSPH4275TTR	BSPH4320TTR	BSPH4385TTR
Replacement Modules:	MOV technology	BPM275IEC	BPM275IEC	BPM320IEC	BPM385IEC
	Spark Gap technology	--	BPSNPEIEC*	BPSNPEIEC*	BPSNPEIEC*
SPECIFICATIONS					
Lightning impulse current (10/350 μs) [N-PE] [I _{imp}]		--	12kA	12kA	12kA
Voltage protection level [U _p]		≤ 1.25kV	--	--	--
Voltage protection level at 5kA [U _p]		≤ 1kV	--	--	--
Voltage protection level [L-N] [U _p]		--	≤ 1.25kV	≤ 1.5kV	≤ 1.75kV
Voltage protection level [L-N] at 5kA [U _p]		--	≤ 1kV	≤ 1.2kV	≤ 1.35kV
Voltage protection level [N-PE] [U _p]		--	≤ 1.5kV	≤ 1.5kV	≤ 1.5kV
Follow current extinguishing capability [N-PE] [I _{fj}]		--	100A _{rms}	100A _{rms}	100A _{rms}
Response time [t _A]		≤ 25 ns	--	--	--
Response time [L-N] [t _A]		--	≤ 25 ns	≤ 25 ns	≤ 25 ns
Response time [N-PE] [t _A]		--	≤ 100 ns	≤ 100 ns	≤ 100 ns
Temporary overvoltage (TOV) [U _T]		335V/5 sec.	--	--	--
Temporary overvoltage (TOV) [L-N] [U _T]		--	335V/5 sec.	335V/5 sec.	385V/5 sec.
Temporary overvoltage (TOV) [N-PE] [U _T]		--	1200V/200 ms	1200V/200 ms	1200V/200 ms
Short-circuit withstand capability for max. mains-side overcurrent protection		50kA _{rms}	50kA _{rms}	25kA _{rms}	25kA _{rms}
SPD according to EN 61643-11		Type 2			
SPD according to IEC 61643-1		Class II			
Nominal AC voltage [U _N]		230/400V			
Nominal discharge current (8/20 μs) [I _n]		20kA			
Max. discharge current (8/20 μs) [I _{max}]		40kA			
Max. mains-side overcurrent protection		125A gL/gG			
TOV characteristics		withstand			
Operating temperature range [T _U]		-40°C to +80°C			
Operating state/fault indication		green (good)/red (replace)			
Number of ports		1			
Cross-sectional area (min.)		1.5mm ² /14AWG solid/flexible			
Cross-sectional area (max.)		35mm ² /2AWG stranded-25mm ² /4AWG flexible			
Mounting		35mm DIN rail per EN 60715			
Enclosure material		Thermoplastic, UL 94V0			
Location category		Indoor			
Degree of protection		IP20			
Capacity		4 mods., DIN 43880			
Standards Information		KEMA			
Product Warranty		Five Years**			
REMOTE CONTACT SIGNALING					
Remote Contact Signaling Type		Changeover Contact			
AC Switching Capacity (Volts/Amps)		250V/0.1A			
DC Switching Capacity (Volts/Amps)		250V/0.1A; 125V/0.2A; 75V/0.5A			
Conductor Ratings and Cross-Sectional Area for Remote Contact Signal Terminals		60/75°C Max. 1.5mm ² /14AWG Solid/Flexible			
Ordering Information		Order from Catalog Numbers Above			

* N-PE Surge arrester module for location between neutral conductor and protective conductor in TT systems.

** See Bussmann SPD Limited Warranty Statement (3A1502) for details at www.cooperbussmann.com/surge.

Recommended Bussmann Back Up Fuses	
DIN Fuse Size	NH Fuse Part Number
00	125NHG00B
0	125NHG0B
01	125NHG01B
02	125NHG02B

Photovoltaic DIN-Rail Lightning SPD

BSPS ___ PV



Dimensions - mm

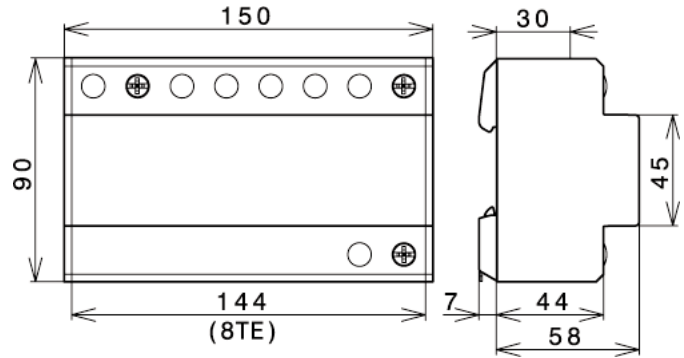

Description

The Bussmann combined lightning current and surge arrester (SPD Class I according to IEC 61643-1) is for use in photovoltaic power supply systems.

- Prewired combined lightning current and surge arrester for use in photovoltaic generator circuits
- For use in photovoltaic installations up to 1000V U_{CPV}
- High lightning current discharge capacity using spark gap technology
- Maximum system availability due to spark gap technology with DC current extinction

Module Circuit Diagrams

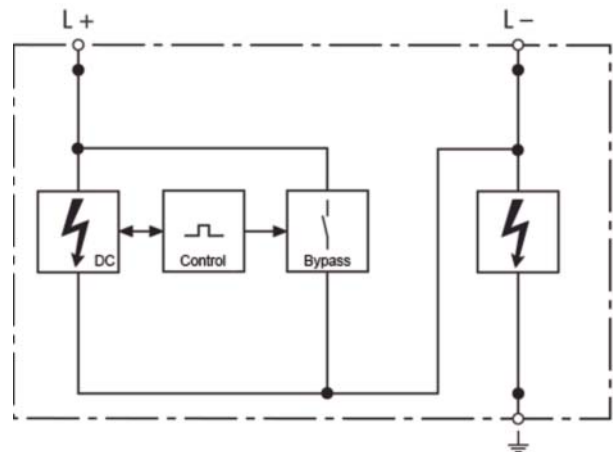

Surge Protection Devices

Photovoltaic DIN-Rail Lightning SPD

Ordering Information	
Max. PV System Voltage	1000Vdc
Catalog Number:	BSPS31000PV
Specifications	
SPD Classification according to EN 61643-11	Type 1
SPD Classification according to IEC 61643-1	Class I
Max. PV voltage [U _{CPV}] of the PV generator	1000V
Max. Continuous operating DC voltage [U _{max DC}]	1000V
Min. Continuous operating DC voltage [U _{min DC}]	100V
Follow current extinguishing capability DC [I _f DC]	100A
Nominal discharge current (8/20 μs) [I _n]	100kA
Lightning impulse current (10/350 μs) [L+/L- -> PE] [I _{imp}]	50kA
Specific energy [L+/L- -> PE] [W/R]	625.00 kJ/ohms
Lightning impulse current (10/350 μs) [L+ -> L-] [I _{imp}]	25kA
Specific energy [L+ -> L-] [W/R]	156.25 kJ/ohms
Voltage protection level [L+ -> L-] [U _p]	≤ 3.3kV
Voltage protection level [(L+/L-) -> PE] [U _p]	≤ 4kV
Operating current [I _{N DC}]	≤ 5mA
Response time [L+ -> L-] [t _A]	≤ 20 ns
Protective conductor current [I _{PE}]	≤ 1μA
Operating temperature range [T _o]	-40°C to +60°C
Number of ports	1
Cross-sectional area (min.)	10mm ² /6AWG solid/flexible
Cross-sectional area (max.)	50mm ² /2AWG stranded/ 35mm ² /1AWG flexible
Mounting	35mm DIN rail per EN 60715
Enclosure material	Thermoplastic, UL 94V0
Place of installation	Indoor
Degree of protection	IP-20
Capacity	8 Mods., DIN 4
Product Warranty	Five Years*

* See Bussmann document 3A1502 on the web at www.cooperbussmann.com.

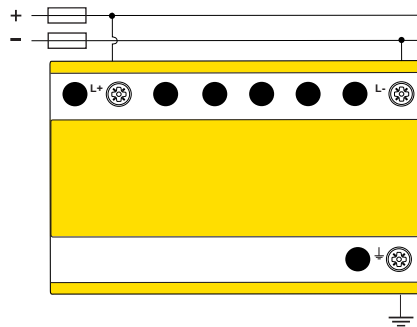

Photovoltaic DIN-Rail SPD

BSPH2_ _ _ PV



Type 4



easyID™
Visual Status Indication



Remote Signal Contact Available



Dimensions - mm

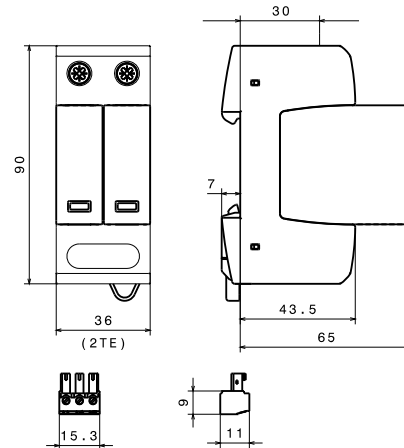

Shown with optional remote contact signaling

Module Circuit Diagrams

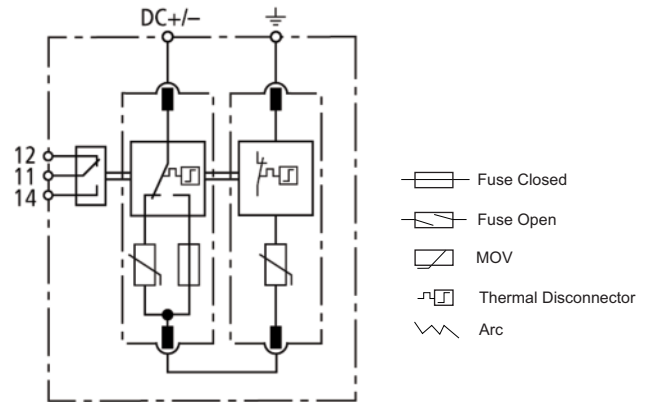

BSPH2600PV*

Shown with optional remote contact signaling

Description

The Bussmann modular Surge Protective Device (SPD) (with two-step DC switching device) features *easyID™* visual indication and optional remote contact signaling (floating changeover contact) for use in photovoltaic systems.

This complete surge protective device is suitable for all PV systems in accordance with UL 1449 3rd Edition and IEC 60364-7-712. Includes a five year limited warranty.

This prewired solution consist of a base and locking modules that feature a combined disconnection and short-circuiting (shunting) device with safe electrical isolation to prevent fire damage due to DC arcs. An integrated DC fuse allows safe module replacement without arc formation.

In case of insulation faults in the generator circuit, a reliable and tested fault-resistant circuit prevents damage to the surge protective devices.

The green and red visual indicator flags show the module protective status (green = good, red = replace). Apart from this visual indication, the remote signaling option features a three terminal floating changeover contact that can be used as a make or break contact depending on the particular monitoring system design employed.

Short-Circuit Interrupting (SCI) Technology

1. Original State
2. Disconnection Device Response
3. Arc Extinguishes
4. Safe Electrical Isolation

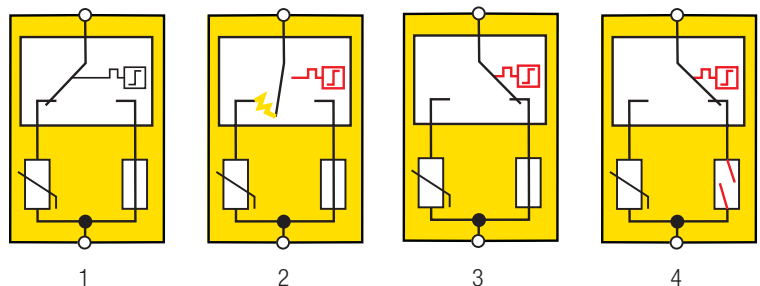

Data Sheet: 2145

Photovoltaic DIN-Rail SPD

Ordering Information		
Nominal PV System Voltage		600Vdc
Catalog Numbers: (Base + Modules)	Without Remote Signaling	BSPH2600PV
	With Remote Signaling	BSPH2600PVR
Replacement Modules:	Left	BPH300YPV
	Right	BPM300YPV
Specifications		
Conformity with prEN 50539-11		Yes
SPD Classification per EN 61643-11		Type 2
SPD Classification per IEC 61643-1		Class II
Max. PV voltage [U _{CPV}]		≤ 600V
Short-circuit withstand capacity [I _{SCWPV}]		1000A
MCOV [U _{CPV}]		700Vdc
Nominal discharge current (8/20 μs) [(DC+/DC-) --> PE] [I _n]		12.5kA
Max. Discharge current (8/20 μs) [(DC+/DC-) --> PE] [I _{max}]		25kA
Voltage protection level [U _p]		≤ 2.5kV
Voltage protection level at 5kA [U _p]		≤ 2kV
Response time [t _A]		≤ 25 ns
Operating temperature range [T _U]		-40°C to +80°C
Operating state/fault indication		Green (good) / Red (replace)
Number of ports		1
Cross-sectional area (min.)		60/75°C 1.5mm ² /14AWG Solid/Flexible
Cross-sectional area (max.)		60/75°C 35mm ² /2AWG Stranded/25mm ² /4AWG Flexible
For mounting on		35 mm DIN rail per EN 60715
Enclosure material		Thermoplastic, UL 94V0
Place of installation		Indoor
Degree of protection		IP20
Capacity		2 Modules, DIN 43880
Standards Information		UL
Product Warranty		Five Years*
Remote Contact Signaling		
Remote Contact Signaling Type		Changeover Contact
AC Switching Capacity (Volts/Amps)		250V/0.1A
DC Switching Capacity (Volts/Amps)		250V/0.1A; 125V/0.2A; 75V/0.5A
Conductor Ratings and Cross-Sectional Area for Remote Contact Signal Terminals		60/75°C Max. 1.5mm ² /14AWG Solid/Flexible
Ordering Information		Order from Catalog Numbers Above

* See Bussmann SPD Limited Warranty Statement (3A1502) for details at www.cooperbussmann.com/surge.

Typical Application Schematic

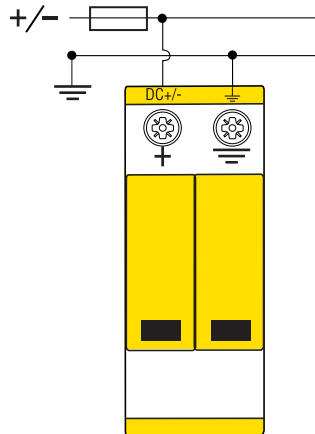

Photovoltaic DIN-Rail SPD

BSPH___YPV

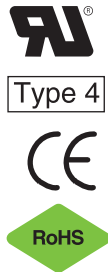

Dimensions - mm

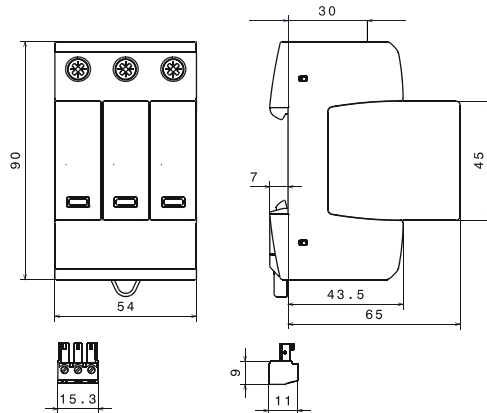

Shown with optional remote contact signaling



Description

The Bussmann three-module photovoltaic Surge Protective Device (SPD) (with three-step DC switching device) features *easyID™* visual indication and optional remote contact signaling (floating changeover contact) for use in PV systems.

These complete surge protective devices are suitable for all PV systems in accordance with UL 1449 3rd Edition and IEC 60364-7-712. Includes a five year limited warranty.

These prewired solutions consist of a base and locking modules that feature a combined disconnection and short-circuiting (shunting) device with safe electrical isolation to prevent fire damage due to DC arcs. An integrated DC fuse allows safe module replacement without arc formation.

In case of insulation faults in the generator circuit, a reliable and tested fault-resistant Y circuit prevents damage to the surge protective devices.

The green and red visual indicator flags show the module protective status (green = good, red = replace). Apart from this visual indication, the remote signaling option features a three terminal floating changeover contact that can be used as a make or break contact depending on the particular monitoring system design employed.

Module Circuit Diagrams

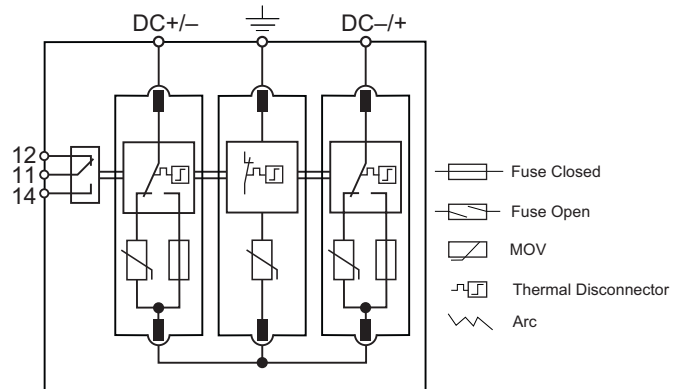

BSPH___YPV*

Shown with optional remote contact signaling

*For remote signaling contact, add "R" suffix to the part number, E.g., BSPH___YPVR

Short-Circuit Interrupting (SCI) Technology

1. Original State
2. Disconnection Device Response
3. Arc Extinguishes
4. Safe Electrical Isolation

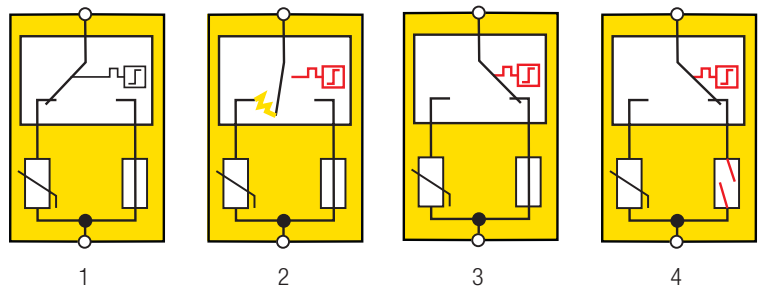

Data Sheet: 2055

Photovoltaic DIN-Rail SPD

Ordering Information				
Nominal PV System Voltage		600Vdc	1000Vdc	1200Vdc
Catalog Numbers: (Base + Modules)	Without Remote Contact Signaling	BSPH3600YPV	BSPH31000YPV	BSPH31200YPV
	With Remote Contact Signaling	BSPH3600YPVR	BSPH31000YPVR	BSPH31200YPVR
Replacement Modules:	Outer (2 modules installed)	BPH300YPV	BPH500YPV	BPH600YPV
	Center (1 module installed)	BPM300YPV	BPM500YPV	BPM600YPV
Specifications				
Nominal PV System Voltage		600V	1000V	1200V
MCOV [U_{CPV}]		700Vdc	1170Vdc	1200Vdc
Max System Discharge Current (8/20 μ s) [I_{max}]		40kA	40kA	30kA
Voltage Protection Level [U_p]		$\leq 2.5kV$	$\leq 4.0kV$	$\leq 4.5kV$
Voltage Protection Level at 5kA [U_p]		$\leq 2.0kV$	$\leq 3.5kV$	$\leq 4.0kV$
Integrated Fuse Breaking Capacity/Interrupting Rating		30kA / 1000Vdc	30kA / 1000Vdc	30kA / 1200Vdc
Technology		Short-Circuit Interruption (SCI) Overcurrent Protection		
Operating Temperature Range [T_{ij}]		-40°C to +80°C		
Nominal Discharge Current (8/20 μ s) [(DC+/DC-) --> PE] [I_n]		12.5kA		
Response Time [t_A]		$\leq 25ns$		
Operating State/Fault Indication		Green (good) / Red (replace)		
Conductor Ratings and Cross-Sectional Area: Minimum		60/75°C 1.5mm ² / 14AWG Solid/Flexible		
	Maximum	60/75°C 35mm ² / 2AWG Stranded / 25mm ² / 4AWG Flexible		
Mounting		35mm DIN Rail per EN 60715		
Enclosure Material		UL 94V0 Thermoplastic		
Degree of Protection		IP20		
Capacity		3 Modules, DIN 43880		
Standards Information:	UL	UL 1449 3 rd Edition (Type 2)*		
	IEC	IEC 61643-11 Type 2, IEC 61643-1 Class II		
Product Warranty		Five Years**		
Remote Contact Signaling				
Remote Contact Signaling Type		Changeover Contact		
AC Switching Capacity (Volts/Amps)		250V / 0.1A		
DC Switching Capacity (Volts/Amps)		250V / 0.1A; 125V / 0.2A; 75V / 0.5A		
Conductor Ratings and Cross-Sectional Area for Remote Contact Signal Terminals		60/75°C Max. 1.5mm ² / 14AWG Solid/Flexible		
Ordering Information		Order from Catalog Numbers Above		

* Does not apply to 1200Vdc.

** See Bussmann SPD Limited Warranty Statement (3A1502) for details at www.cooperbussmann.com/surge.

Typical Application Schematics

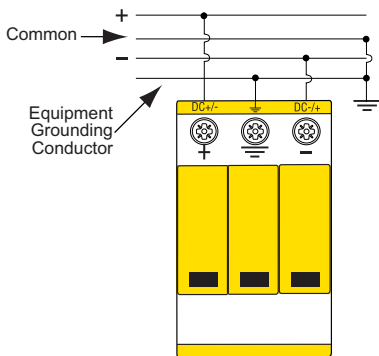

Application A
Two energized poles/modes
600, 1000 & 1200Vdc systems

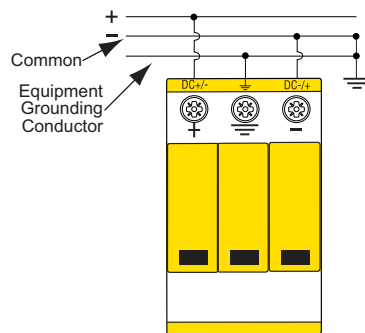

Application B
One energized pole/mode
600Vdc & 1000Vdc systems only

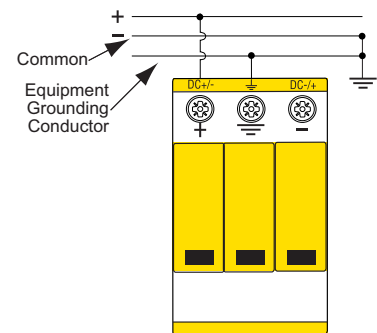

Application C
One energized pole/mode
600Vdc & 1000Vdc systems only
(Max. system discharge current
(8/20 μ s) [I_{max}] 25kA)

Photovoltaic DIN-Rail SPD

BSPP___YPV(R)

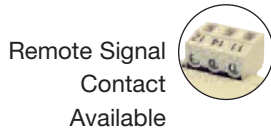
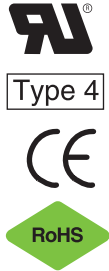

Dimensions - mm

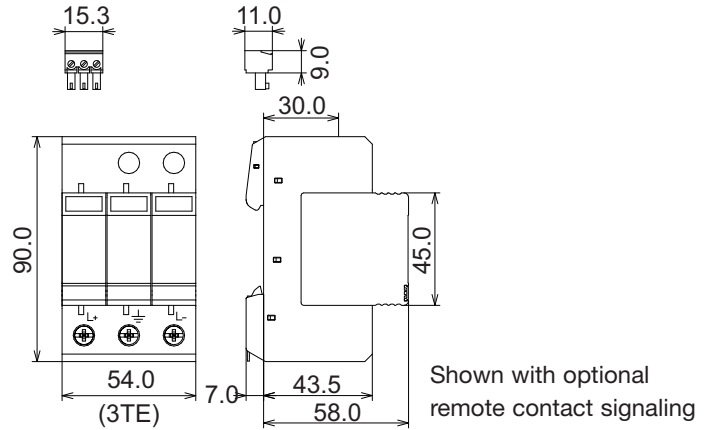

Module Circuit Diagrams

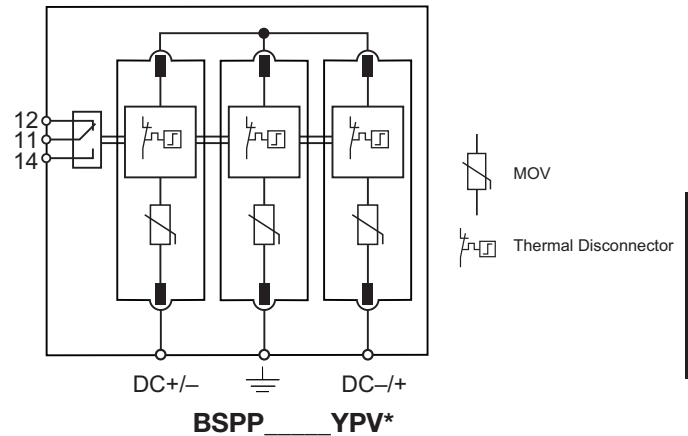

Shown with optional remote contact signaling
* For remote signaling contact, add "R" suffix to the part number.
E.g., BSPP3600YPVR

Description

The Bussmann three-module photovoltaic Surge Protective Device (SPD) features *easyID™* visual indication and optional remote contact signaling (floating changeover contact) for use in PV systems.

These complete surge protective devices are suitable for all PV systems in accordance with UL 1449 3rd Edition, EN 50539-11 and IEC 60364-7-712. Includes a two year limited warranty.

These prewired solutions consist of a base and modules that feature a disconnection device in the event of an overload.

In case of insulation faults in the generator circuit, a reliable and tested fault-resistant Y circuit prevents damage to the surge protective devices.

The green and red visual indicator flags show the module protective status (green = good, red = replace). Apart from this visual indication, the remote signaling option features a three terminal floating changeover contact that can be used as a make or break contact depending on the particular monitoring system design employed.

Surge Protection Devices

Wind IEC Class I DIN-Rail SPD

Ordering Information			
Nominal PV System Voltage		600Vdc	1000Vdc
Catalog Numbers: (Base + Modules)	Without Remote Contact Signaling	BSPP3600YPV	BSPP31000YPV
	With Remote Contact Signaling	BSPP3600YPVR	BSPP31000YPVR
Replacement Modules:		BPP300SYPV	BPP500SYPV
Specifications			
Nominal PV System Voltage [U _{CPV}]		600V	1000V
MCOV [U _{CPV}]		600Vdc	1000Vdc
Max System Discharge Current (8/20μs) [I _{max}]		40kA	40kA
Voltage Protection Level [U _p]		≤2.5kV	≤4.0kV
Voltage Protection Level at 5kA [U _p]		≤2.0kV	≤3.5kV
Short-Circuit Withstand Capability [I _{SCPV}]		125A	
Technology		Fault Resistant Y MOV Circuit	
Operating Temperature Range [T _U]		-40°C to +80°C	
Nominal Discharge Current (8/20μs) (DC+ → DC-) (DC+/DC- → PE) [I _n]		20kA	
Response Time [t _A]		≤25ns	
Operating State/Fault Indication		Green (good) / Red (replace)	
Conductor Ratings and Cross-Sectional Area:	Minimum	60/75°C 1.5mm ² / 14AWG Solid/Flexible	
	Maximum	60/75°C 35mm ² / 2AWG Stranded / 25mm ² / 4AWG Flexible	
Mounting		35mm DIN-Rail per EN 60715	
Enclosure Material		UL 94V0 Thermoplastic	
Degree of Protection		IP20	
Capacity		3 Modules, DIN 43880	
Standards Information:	UL	UL 1449 3 rd Edition (Type 2)	
	IEC	EN 50539-11, IEC 61643-11 Type 2, IEC 61643-1 Class II	
Product Warranty		Two Years*	
Remote Contact Signaling			
Remote Contact Signaling Type		Changeover Contact	
AC Switching Capacity (Volts/Amps)		250V / 0.1A	
DC Switching Capacity (Volts/Amps)		250V / 0.1A; 125V / 0.2A; 75V / 0.5A	
Conductor Ratings and Cross-Sectional Area for Remote Contact Signal Terminals		60/75°C Max. 1.5mm ² / 14AWG Solid/Flexible	
Ordering Information		Order from Catalog Numbers Above	

Typical Application Schematics

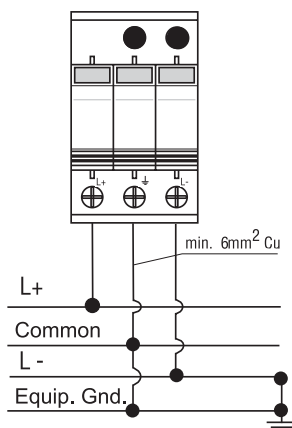

Application A
Two energized poles/modes
600 & 1000Vdc systems

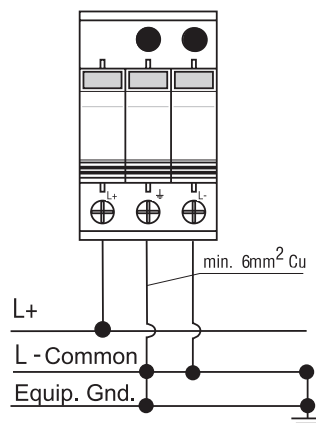

Application B
One energized pole/mode
600Vdc & 1000Vdc systems only

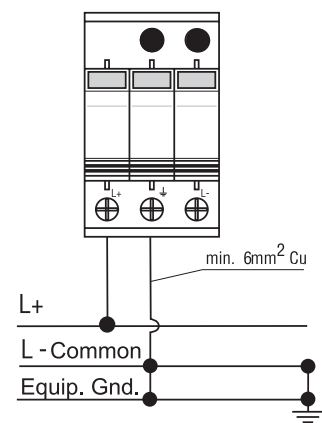

Application C
One energized pole/mode
600Vdc & 1000Vdc** systems

* See Bussmann SPD Limited Warranty Statement (3A1502) for details at www.cooperbussmann.com/surge.

** BSPP31000YPV(R) 1000Vdc one energized pole/mode requires the following:

1. Use a suitable electrical insulator to keep a 10mm min. safety distance from the PV-SPD and other grounded parts in the housing.
2. No metal covers are in the area of the module release buttons as shown.

Wind IEC Class I DIN-Rail SPD

BSPS_ _ _ WE



easyID™

Visual Status Indication



Remote Signal Contact Available



Dimensions - mm

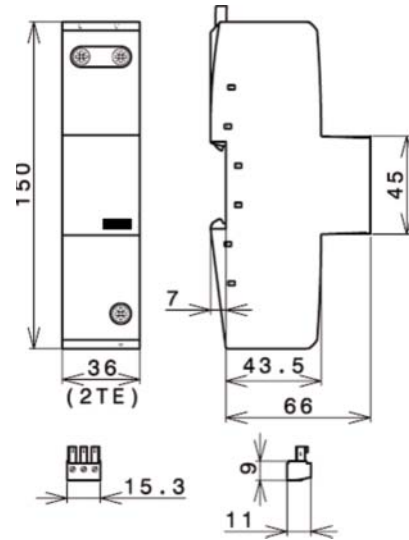

Shown with optional remote contact signaling

Description

The Bussmann IEC Class I 400 and 690V, one-pole lightning current arresters feature local, easyID™ visual indication and optional remote contact signaling.

440V and 760V maximum continuous operating voltage arresters protect installations against surges and direct lightning strikes.

System & Application

TNC 400V/690V: 3x BSPS1400WE(R)

TNS 400/690V: 4x BSPS1400WE(R)

IT 690V: 3x BSPS1690WER

Remote Signaling Contact

The three-pole terminal remote signaling contact versions have a floating changeover contact for use as a break or make contact, according to circuit concept.

Circuit Diagrams - Shown with optional remote contact signaling

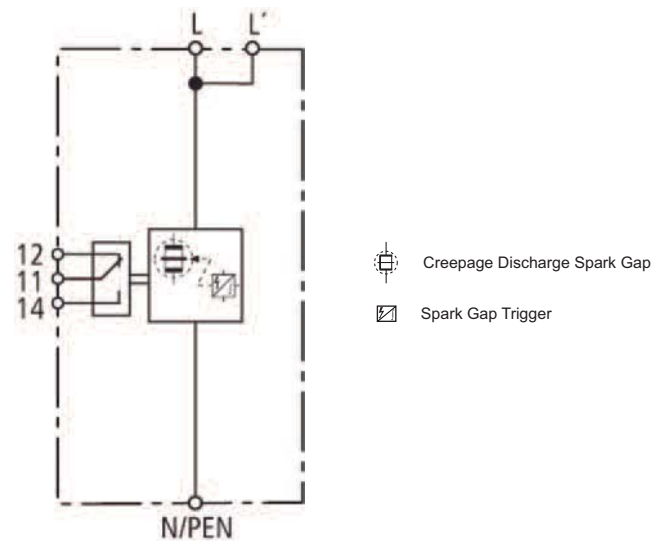

BSPS1400WE*
BSPS1690WE

*For remote signaling contact, add "R" suffix to the part number, E.g., BSPS1400WER

Wind IEC Class I DIN-Rail SPD

Ordering Information		
System Voltage/Poles	400V/1	690V/1
Max. Continuous Operating AC voltage (MCOV) [U _C]	440V	760V
Catalog Numbers:	Without Remote Signaling	BSPS1400WE
	With Remote Signaling	BSPS1400WER
		BSPS1690WER
Specifications		
Line System Type	TNC, TNS, IT	TNC, TNS, IT
Lightning impulse current (10/350 μs) [I _{imp}]	35kA	25kA
Specific Energy [W/R]	306.25kJ/ohms	156.25kJ/ohms
Nominal Discharge Current (8/20 μs) [I _n]	35kA	25kA
Voltage Protection Level [U _p]	≤ 2.5kV	≤ 4kV
Follow Current Extinguishing Capability AC [I _{ff}]	50kA _{rms}	25kA _{rms}
Follow Current Limitation / Selectivity	no tripping of a 32 A gL/gG fuse up to 50 kA _{rms} (prosp.)	no tripping of a 32 A gL/gG fuse up to 25 kA _{rms} (prosp.)
Response Time [t _A]	≤ 100 ns	≤ 100 ns
Max. Backup Fuse (L) up to I _K = 25kA _{rms} (t _a ≤ 5 s)	--	250A gL/gG
Max. Backup Fuse (L) up to I _K > 25kA _{rms}	--	100A gL/gG
Max. Backup Fuse (L) up to I _K = 50kA _{rms} (t _a ≤ 0.2 s)	500A gL/gG	--
Max. Backup Fuse (L) up to I _K = 50kA _{rms} (t _a ≤ 5 s)	250A gL/gG	--
Max. Backup Fuse (L) for I _K > 50kA _{rms}	160A gL/gG	--
Max. Backup Fuse (L-L)	125A gL/gG	125A gL/gG
Short-Circuit Withstand Capability for Max. Mains-Side Overcurrent Protection	50kA _{rms}	25kA _{rms}
Temporary Overvoltage (TOV) [U _T]	690V / 5 sec.	1000V / 5 sec.
Cross-Sectional Area (L, L, $\frac{1}{2}$) [min.]	--	10mm ² solid/flexible
Cross-Sectional Area (L, L, N/PEN) [min.]	10mm ² solid/flexible	--
Cross-Sectional Area (L, N/PEN) [max.]	50mm ² /1AWG stranded/35mm ² /2AWG flexible	--
Cross-Sectional Area (L, $\frac{1}{2}$) [max.]	--	50mm ² /1AWG stranded/35 mm ² /2AWG flexible
Cross-Sectional Area (L) [max.]	35mm ² /2AWG stranded/25mm ² /4AWG flexible	35mm ² /2AWG stranded/25mm ² /4AWG flexible
SPD According to EN 61643-11		Type 1
SPD According to IEC 61643-1		Class I
TOV Characteristics		Withstand
Operating Temperature Range (parallel connection) [T _{UP}]		-40°C to +80°C
Operating Temperature Range (series connection) [T _{US}]		-40°C to +60°C
Operating State/Fault Indication		Green (good) / Red (replace)
Number of Ports		1
Mounting		35mm DIN rail per EN 60715
Enclosure Material		Thermoplastic, UL 94V0
Place of Installation		Indoor
Degree of Protection		IP20
Capacity		2 Mods., DIN 43880
Product Warranty		Five Years*
Remote Contact Signaling		
Remote Contact Signaling Type		Changeover Contact
AC Switching Capacity (Volts/Amps)		250V/0.5A
DC Switching Capacity (Volts/Amps)		250V/0.1A; 125V/0.2A; 75V/0.5A
Conductor Ratings and Cross-Sectional Area for Remote Contact Signal Terminals		60/75°C Max. 1.5mm ² / 14AWG Solid/Flexible
Ordering Information		Order from Catalog Numbers Above

Recommended Bussmann NH DIN Size Back Up Fuses	
Size	NH Fuse Part Number
000	100NHG000B-690 (max L) up to I _K > 25kA _{rms}
00	125NHG000B-690 (max L-L)
01	160NHG01B-690 (max L) for I _K > 50kA _{rms}
02	250NHG02B-690 (max L) up to I _K = 25kA _{rms} (t _a ≤ 5 s)
02	250NHG02B-690 (max L) up to I _K = 50kA _{rms} (t _a ≤ 5 s)
3	500NHG3B-690 (max L) up to I _K = 50kA _{rms} (t _a ≤ 0.2 s)

* See Bussmann SPD Limited Warranty Statement (3A1502) for details at www.cooperbussmann.com/surge.

Wind IEC Class II DIN-Rail SPD

BSPM_ _ _ WE, BSPS_ _ _ WE



easyID™

Visual Status Indication



Remote Signal Contact Available



Module Circuit Diagrams - Shown with optional remote contact signaling

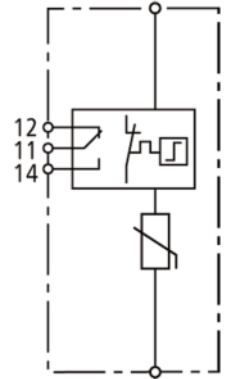
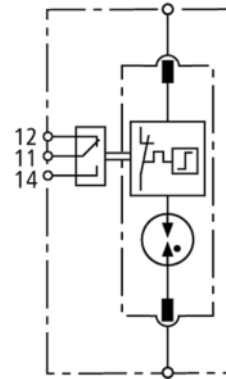
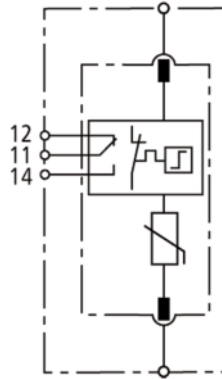

BSPM175WE*
BSPM1400WE
BSPM1690WE

BSPG1230WE*

BSPM11000WE*

MOV Thermal Disconnect Gas Discharge Tube (single)

*For remote signaling contact, add "R" suffix to the part number, E.g., BSPM175WER

Description

The Bussmann IEC Class II 75, 230, 400, 690 and 1000V, one-pole, modular surge arresters feature local, easyID™ visual indication and optional remote contact signaling. The unique module locking system on the 75 to 690V arresters fixes the protection module to the base part. Modules can be easily replaced without tools by simply depressing the release buttons. Integrated mechanical coding between the base and protection module ensures against installing an incorrect replacement module.

TN System Arresters (also 1-Phase TT systems)

The features of these single-pole devices are for use as a single device or in combination with other devices.

TT System Arrester

Provides a current arresting means between neutral conductor and protective conductor in TT systems, this device helps ensure fulfilling the requirements for protection of personnel and equipment in "3+1" and "1+1" circuits.

Remote Signaling Contact

The three-pole terminal remote signaling contact versions have a floating changeover contact for use as a break or make contact, according to circuit concept.

Dimensions - mm

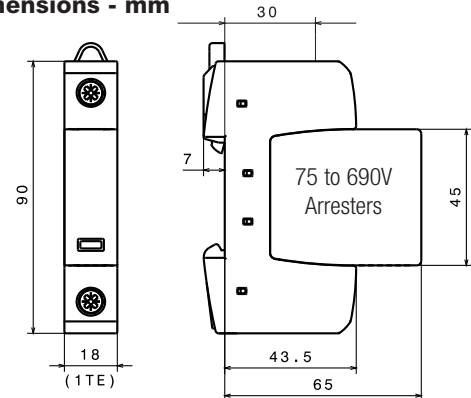

Shown with optional remote contact signaling

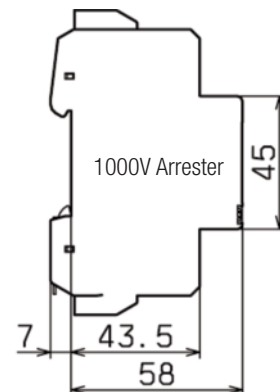
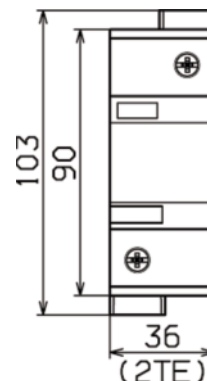

Surge Protection Devices

Wind IEC Class II DIN-Rail SPD

Ordering Information						
System Voltage/Poles	75V/1	230V/1	400V/1	690V/1	1000V/1	
Max. Continuous operating AC voltage (MCOV) [U _C]	75V	255V	440V	600V	1000V	
Catalog Numbers:	Without Remote Signaling	BSPM175WE	BSPG1230WE	BSPM1400WE	BSPM1690WE	BSPM11000WE
(Base + Modules)	With Remote Signaling	BSPM175WER	BSPG1230WER	BSPM1400WER	BSPM1690WER	BSPM11000WER
Replacement Modules		BPM75WE	BPG255NPEWE*	BPM440WE	BPM750WE	N/A
Specifications						
Line System Type	TN / TT	TT	TN / TT	TN / TT	TN / TT	
Max. Continuous Operating DC Voltage [U _C]	100V	--	585	600V	1000V	
Rated Varistor Voltage AC [U _{MOV}]	--	--	--	750V	1000V	
Nominal Discharge Current (8/20 μs) [I _n]	10kA	20kA	20kA	15kA	15kA	
Max. Discharge Current (8/20 μs) [I _{max}]	40kA	40kA	40kA	25kA	30kA	
Follow Current Extinguishing Capability [I _{fi}]	--	100 A _{rms}	--	--	--	
Lightning Impulse Current (10/350 μs) [I _{imp}]	--	12kA	--	--	--	
Voltage Protection Level [U _p]	≤ 0.4kV	≤ 1.5kV	≤ 2.0kV	≤ 3kV	≤ 4.2kV	
Voltage Protection Level at 5kA [U _p]	≤ 0.35kV	--	≤ 1.7kV	≤ 2.5kV	≤ 3.5kV	
Response Time [t _A]	≤ 25 ns	≤ 100 ns	≤ 25 ns	≤ 25 ns	≤ 25 ns	
Max. Mains-side Overcurrent Protection	125A gL/gG	--	125A gL/gG	100A gL/gG	100A aM**	
Short-Circuit Withstand Capability for Max. Mains-side Overcurrent Protection	50kA _{rms}	--	25kA _{rms}	25kA _{rms}	25kA _{rms}	
Temporary Overvoltage (TOV) [U _T]	90V / 5 sec.	1200V / 200ms	580V / 5 sec.	900V / 5 sec.	1000V / 5 sec.	
Standards Information	KEMA, CSA	KEMA	KEMA, CSA	KEMA, CSA	--	
Capacity	1 Mod., DIN 43880	1 Mod., DIN 43880	1 Mod., DIN 43880	1 Mod., DIN 43880	2 Mod., DIN 43880	
SPD According to EN 61643-11	Type 2					
SPD According to IEC 61643-1	Class II					
TOV Characteristics	Withstand					
Operating Temperature Range [T _U]	-40°C to +80°C					
Operating State/Fault Indication	Green (good) / Red (replace)					
Number of Ports	1					
Cross-Sectional Area (min.)	1.5mm ² /14AWG solid/flexible					
Cross-Sectional Area (max.)	35mm ² /2AWG stranded-25mm ² /4AWG flexible					
Mounting	35mm DIN rail per EN 60715					
Enclosure Material	Thermoplastic, UL 94V0					
Location Category	Indoor					
Degree of Protection	IP20					
Product Warranty	Five Years***					
Remote Contact Signaling						
Remote Contact Signaling Type	Changeover Contact					
AC Switching Capacity (Volts/Amps)	250V/0.5A					
DC Switching Capacity (Volts/Amps)	250V/0.1A; 125V/0.2A; 75V/0.5A					
Conductor Ratings and Cross-Sectional Area for Remote Contact Signal Terminals	60/75°C Max. 1.5mm ² /14AWG Solid/Flexible					
Ordering Information	Order from Catalog Numbers Above					

* N-PE Surge arrester for location between neutral conductor and protective conductor in TT systems.

** 125A gL/gG @ 690Vac.

*** See Bussmann SPD Limited Warranty Statement (3A1502) for details at www.cooperbussmann.com/surge.

Recommended Bussmann Back Up Fuses	
DIN Fuse Size	NH Fuse Part Number
00	100NHG00B-690
00	125NHG00B-690

Wind IEC Class II DIN-Rail SPD

BSPM____WE, BSPH____WE



easyID™

Visual Status Indication



Remote Signal Contact Available



Dimensions - mm

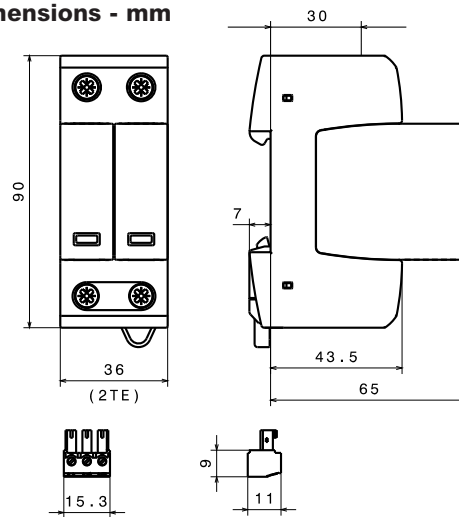

Shown with optional remote contact signaling

Module Circuit Diagrams - Shown with optional remote contact signaling

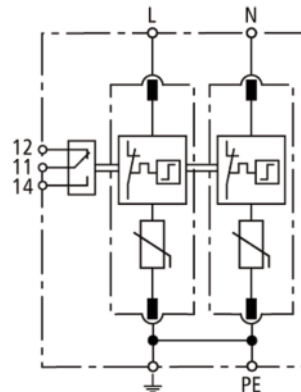

BSPM2230WE*

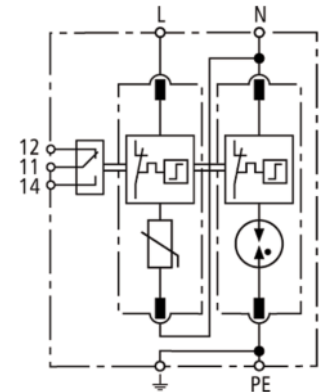

BSPH2230WE*

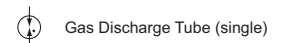

Description

The Bussmann IEC Class II 230V, two-pole, modular surge arresters feature local, easyID™ visual indication and optional remote contact signaling. The unique module locking system fixes the protection module to the base part. Modules can be easily replaced without tools by simply depressing the release buttons. Integrated mechanical coding between the base and protection module ensures against installing an incorrect replacement module.

TN System Arrester

The features of these two-pole device are for use as a single device.

TT System Arrester

For use as a single device in a 1-phase TT system.

Remote Signaling Contact

The three-pole terminal remote signaling contact versions have a floating changeover contact for use as a break or make contact, according to circuit concept.

Surge Protection Devices

Wind IEC Class II DIN-Rail SPD

Ordering Information		
System Voltage/Poles	230V/2	230V/2
Max. Continuous operating AC voltage (MCOV) [U _C]	275V	275 / 255V
Catalog Numbers:		
Without Remote Signaling	BSPM2230WE	BSPH2230WE
(Base + Modules) With Remote Signaling	BSPM2230WER	BSPH2230WER
Replacement Modules		
MOV	BPM275WE	BPM275WE
Spark Gap	--	BPSNPEWE*
Specifications		
Line System Type	TN	TT
Max. Continuous Operating AC Voltage [L-N] [U _C]	--	275V
Max. Continuous Operating AC Voltage [N-PE] [U _C]	--	255V
Nominal Discharge Current (8/20 μs) [I _n]	20kA	20kA
Max. Discharge Current (8/20 μs) [I _{max}]	40kA	40kA
Lightning Impulse Current (10/350 μs) [N-PE] [I _{imp}]	--	12kA
Voltage Protection Level [U _p]	≤ 1.25kV	--
Voltage Protection Level at 5kA [U _p]	≤ 1kV	--
Voltage Protection Level [L-N] [U _p]	--	≤ 1.25kV
Voltage Protection Level [L-N] at 5kA [U _p]	--	≤ 1kV
Voltage Protection Level [N-PE] [U _p]	--	≤ 1.5kV
Follow Current Extinguishing Capability [N-PE] [I _f]	--	100A _{rms}
Response Time [L-N] [t _A]	--	≤ 25 ns
Response Time [N-PE] [t _A]	--	≤ 100 ns
Response Time [t _A]	≤ 25 ns	--
Max. Mains-side Overcurrent Protection	125A gL/gG	125A gL/gG
Short-circuit Withstand Capability for Max. Mains-side Overcurrent Protection	50kA _{rms}	50kA _{rms}
Temporary Overvoltage (TOV) [U _T]	335 V / 5 sec.	--
Temporary Overvoltage (TOV) [L-N] [U _T]	--	335V / 5 sec.
Temporary Overvoltage (TOV) [N-PE] [U _T]	--	1200V / 200 ms
SPD According to EN 61643-11	Type 2	
SPD According to IEC 61643-1	Class II	
TOV Characteristics	Withstand	
Operating Temperature Range [T _U]	-40°C to +80°C	
Operating State/Fault Indication	Green (good) / Red (replace)	
Number of Ports	1	
Cross-sectional Area (min.)	1.5mm ² /14AWG solid/flexible	
Cross-sectional Area (max.)	35mm ² /2AWG stranded-25mm ² /4AWG flexible	
Mounting	35mm DIN rail per EN 60715	
Enclosure Material	Thermoplastic, UL 94V0	
Location Category	Indoor	
Degree of Protection	IP20	
Capacity	2 Mods., DIN 43880	
Standards Information	KEMA	
Product Warranty	Five Years**	
Remote Contact Signaling		
Remote Contact Signaling Type	Changeover Contact	
AC Switching Capacity (Volts/Amps)	250V/0.5A	
DC Switching Capacity (Volts/Amps)	250V/0.1A; 125V/0.2A; 75V/0.5A	
Conductor Ratings and Cross-Sectional Area for Remote Contact Signal Terminals	60/75°C Max. 1.5mm ² / 14AWG Solid/Flexible	
Ordering Information	Order from Catalog Numbers Above	

* N-PE Surge arrester for location between neutral conductor and protective conductor in TT systems.

** See Bussmann SPD Limited Warranty Statement (3A1502) for details at www.cooperbussmann.com/surge.

Recommended Bussmann Back Up Fuse	
DIN Fuse Size	NH Fuse Part Number
00	125NHG00B

Wind IEC Class II DIN-Rail SPD

BSPM___WE



easyID™

Visual Status Indication



Remote Signal Contact Available



Dimensions - mm

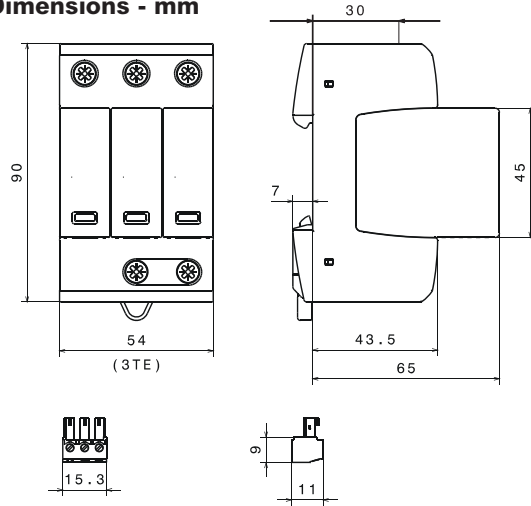

Shown with optional remote contact signaling

Module Circuit Diagrams - Shown with optional remote contact signaling

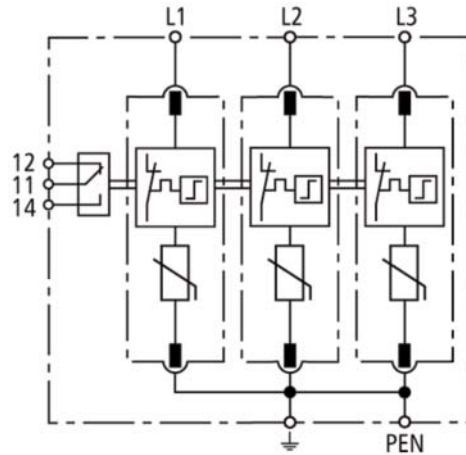

BSPM3230WE
BSPM3400WE
BSPM3690WE

- MOV
- Thermal Disconnector

Specifications Description

The Bussmann IEC Class II 230, 400 and 690V three-pole, modular surge arresters feature local, easyID™ visual indication and optional remote contact signaling. The unique module locking system fixes the protection module to the base part. Modules can be easily replaced without tools by simply depressing the release buttons. Integrated mechanical coding between the base and protection module ensures against installing an incorrect replacement module.

TNC System Arresters

The features of these three-pole devices are for use as a single device.

Remote Signaling Contact

The three-pole terminal remote signaling contact versions have a floating changeover contact for use as a break or make contact, according to circuit concept.

Wind IEC Class II DIN-Rail SPD

Ordering Information			
System Voltage/Poles	230V/3	400V/3	690V/3
Max. Continuous operating AC voltage (MCOV) [U _C]	275V	440V	600V
Catalog Numbers: (Base + Modules)	Without Remote Signaling BSPM3230WE	BSPM3400WE	BSPM3690WE
	With Remote Signaling BSPM3230WER	BSPM3400WER	BSPM3690WER
Replacement Modules	BPM275WE	BPM440WE	BPM750WE
Specifications			
Line System Type	TNC	TNC	TNC
Nominal AC Voltage [U _N]	230/400V	400/690V	600V
Rated Varistor Voltage [U _{MOV}]	275V	440V	750V
Nominal Discharge Current (8/20 μs) [I _n]	20kA	20kA	15kA
Max. Discharge Current (8/20 μs) [I _{max}]	40kA	40kA	25kA
Voltage Protection Level [U _p]	≤1.25kV	≤ 2kV	≤3kV
Voltage Protection Level at 5kA [U _p]	≤1kV	≤ 1.7kV	≤2.5kV
Response Time [t _A]	≤25 ns	≤ 25 ns	≤25 ns
Max. Mains-side Overcurrent Protection	125A gL/gG	125A gL/gG	100A gL/gG
Short-circuit Withstand Capability for Max. Mains-side Overcurrent Protection	50kA _{rms}	25kA _{rms}	25kA _{rms}
Temporary Overvoltage (TOV) [U _T]	335V / 5 sec.	580V / 5 sec.	900V / 5 sec.
SPD According to EN 61643-11	Type 2		
SPD According to IEC 61643-1	Class II		
TOV Characteristics	Withstand		
Operating Temperature Range [T _U]	-40°C to +80°C		
Operating State/Fault Indication	Green (good) / Red (replace)		
Number of Ports	1		
Cross-Sectional Area (min.)	1.5mm ² /14AWG solid/flexible		
Cross-Sectional Area (max.)	35mm ² /2AWG stranded-25mm ² /4AWG flexible		
Mounting	35mm DIN rail per EN 60715		
Enclosure Material	Thermoplastic, UL 94V0		
Location Category	Indoor		
Degree of Protection	IP20		
Capacity	3 Mods., DIN 43880		
Standards Information	KEMA		
Product Warranty	Five Years*		
Remote Contact Signaling			
Remote Contact Signaling Type	Changeover Contact		
AC Switching Capacity (Volts/Amps)	250V/0.5A		
DC Switching Capacity (Volts/Amps)	250V/0.1A; 125V/0.2A; 75V/0.5A		
Conductor Ratings and Cross-Sectional Area for Remote Contact Signal Terminals	60/75°C Max. 1.5mm ² /14AWG Solid/Flexible		
Ordering Information	Order from Catalog Numbers Above		

* See Bussmann SPD Limited Warranty Statement (3A1502) for details at www.cooperbussmann.com/surge.

Recommended Bussmann Back Up Fuse	
DIN Fuse Size	NH Fuse Part Number
00	100NHG00B-690
	125NHG00B-690

Wind IEC Class II DIN-Rail SPD

BSPM____WE, BSPH____WE

Dimensions - mm

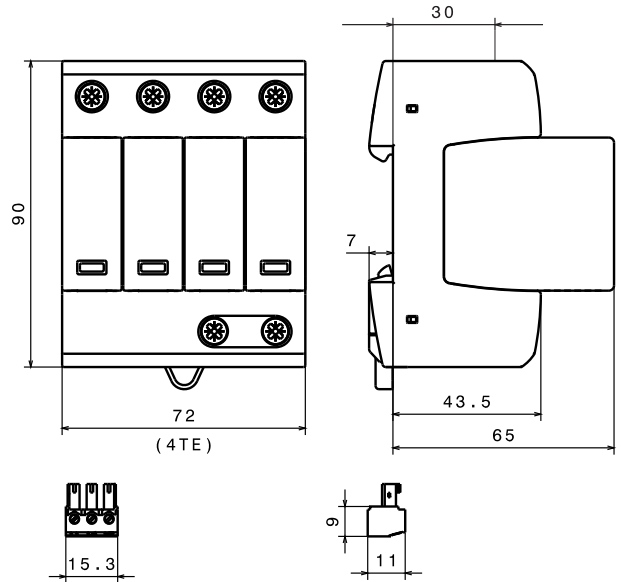

easyID™
Visual Status Indication

Remote Signal Contact Available

Shown with optional remote contact signaling

Specifications Description

The Bussmann IEC Class II 230/400V, four-pole, modular surge arresters feature local, *easyID™* visual indication and optional remote contact signaling. The unique module locking system fixes the protection module to the base part. Modules can be easily replaced without tools by simply depressing the release buttons. Integrated mechanical coding between the base and protection module ensures against installing an incorrect replacement module.

These 230V models are offered with MCOV ratings of 275V.

TNS System Arrester

The features of these four-pole devices are for use in TNS 230/400V systems ("4-0" circuit) against surges.

TT System Arrester

The features of these four-pole devices are for use in TT and TN-S 230/400V systems ("3+1" circuit) against surges.

Remote Signaling Contact

The three-pole terminal remote signaling contact versions have a floating changeover contact for use as a break or make contact, according to circuit concept.

Circuit Diagrams - Shown with optional remote contact signaling

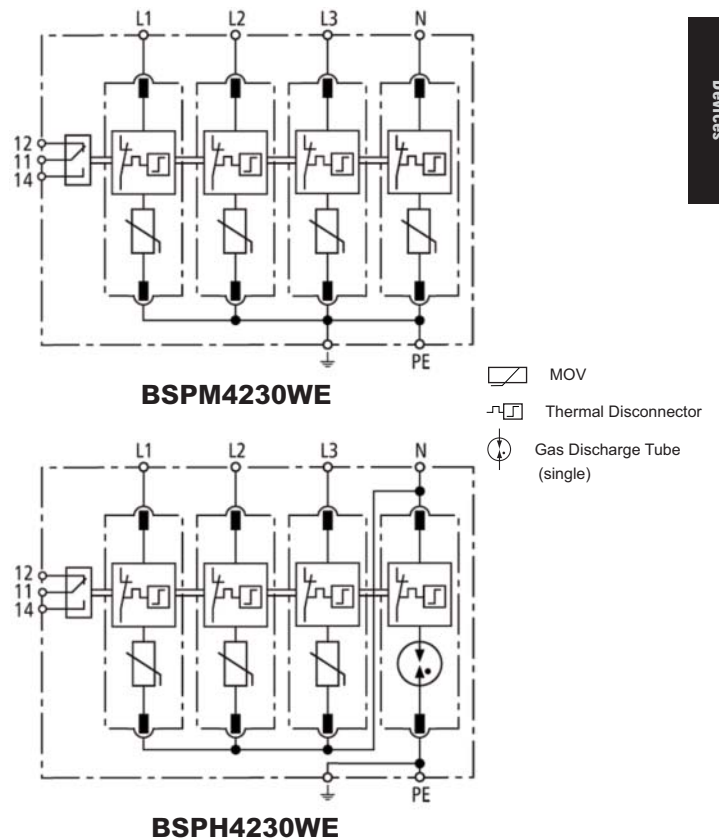

Surge Protection Devices

Wind IEC Class II DIN-Rail SPD

ORDERING INFORMATION			
System Voltage/Poles	230/400V/4	230/400V/4	
Max. continuous operating AC voltage (MCOV) [U _C]	275V	--	
Max. continuous operating AC voltage (MCOV) [L-N] [U _C]	--	275V	
Max. continuous operating AC voltage [N-PE] [U _C]	--	255V	
Catalog Numbers:	Without Remote Signaling	BSPM4230WE	BSPH4230WE
	With Remote Signaling	BSPM4230WER	BSPH4230WER
Replacement Modules:	MOV technology	BPM275WE	BPM275WE
	Spark Gap technology	--	BPSNPEWE*
SPECIFICATIONS			
Line System Type	TNS	TT / TNS	
Nominal AC voltage [U _N]	230/400V	230/400V	
Lightning impulse current (10/350 μs) [N-PE] [I _{imp}]	--	12kA	
Voltage protection level [U _p]	≤ 1.25kV	--	
Voltage protection level at 5kA [U _p]	≤ 1kV	--	
Voltage protection level [L-N] [U _p]	--	≤ 1.25kV	
Voltage protection level [L-N] at 5kA [U _p]	--	≤ 1kV	
Voltage protection level [N-PE] [U _p]	--	≤ 1.5kV	
Follow current extinguishing capability [N-PE] [I _f]	--	100A _{rms}	
Response time [t _A]	≤ 25 ns	--	
Response time [L-N] [t _A]	--	≤ 25 ns	
Response time [N-PE] [t _A]	--	≤ 100 ns	
Temporary overvoltage (TOV) [U _T]	335V / 5 sec.	--	
Temporary overvoltage (TOV) [L-N] [U _T]	--	335V / 5 sec.	
Temporary overvoltage (TOV) [N-PE] [U _T]	--	1200V / 200 ms	
SPD according to EN 61643-11	Type 2		
SPD according to IEC 61643-1	Class II		
Nominal discharge current (8/20 μs) [I _n]	20kA		
Max. discharge current (8/20 μs) [I _{max}]	40kA		
Max. mains-side overcurrent protection	125A gL/gG		
Short-circuit withstand capability for max. mains-side overcurrent protection	50kA rms		
TOV characteristics	withstand		
Operating temperature range [T _{ij}]	-40°C to +80°C		
Operating state/fault indication	green (good)/red (replace)		
Number of ports	1		
Cross-sectional area (min.)	1.5mm ² /14AWG solid/flexible		
Cross-sectional area (max.)	35mm ² /2AWG stranded-25mm ² /4AWG flexible		
Mounting	35mm DIN rail per EN 60715		
Enclosure material	Thermoplastic, UL 94V0		
Location category	Indoor		
Degree of protection	IP20		
Capacity	4 Mods., DIN 43880		
Standards Information	KEMA		
Product Warranty	Five Years**		
REMOTE CONTACT SIGNALING			
Remote Contact Signaling Type	Changeover Contact		
AC Switching Capacity (Volts/Amps)	250V/0.1A		
DC Switching Capacity (Volts/Amps)	250V/0.1A; 125V/0.2A; 75V/0.5A		
Conductor Ratings and Cross-Sectional Area for Remote Contact Signal Terminals	60/75°C Max. 1.5mm ² /14AWG Solid/Flexible		
Ordering Information	Order from Catalog Numbers Above		

Recommended Bussmann Back Up Fuse	
DIN Fuse Size	NH Fuse Part Number
00	125NHG00B

* N-PE Surge arrester module for location between neutral conductor and protective conductor in TT systems.
 ** See Bussmann SPD Limited Warranty Statement (3A1502) for details at www.cooperbussmann.com/surge.

Surge Protection Made Simple™ for Coaxial Data Cables

UL Listed 497B DIN-Rail Mount Surge Protective Device for BNC Connector Cable Systems



Description

The Bussmann BSPD5BNCDD and BSPD5BNCDI two-stage DIN-Rail mounted surge arresters are for protecting coaxial cable-connected systems (such as video and camera systems) from potential damage. The BSPD5BNCDD features direct (VCD) shield connection while the BSPD5BNCDI features indirect shield connection (VCID) to prevent leakage pickups.

The BSPD5BNCDD and BSPD5BNCDI shielded surge arresters are mounted on the supplied bracket with cable lug or mounted on a rack mounted DIN-Rail with suitable grounding. BNC connector terminated data or video signal cables are plugged into surge arrester with the equipment plugged into the protected side.

Common applications include protecting outdoor video surveillance systems or video control centers or coaxial data lines. For BSPD5BNCDI, the cable shield is indirectly grounded via a gas discharge tube to avoid being influenced by leakage pickups.

- UL 497B Listed
- Plug-in surge protective device for easy retrofitting
- The space-saving surge arrester with BNC socket is mounted on supplied rail terminal lug or standard 35mm DIN-Rail
- Integrated direct or indirect shield grounding avoids leakage pickups
- Easily adaptable due to BNC sockets

Dimensions-mm

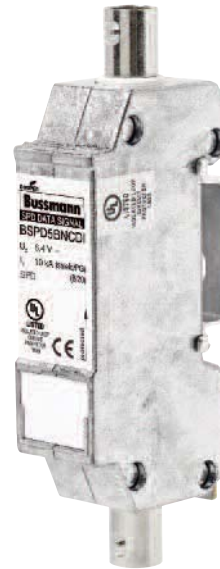
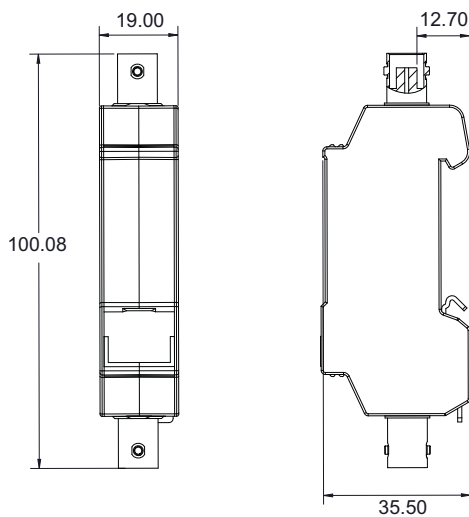

BSPD5BNCDD
BSPD5BNCDI



DIN-Rail Mount SPD for BNC Coax

Circuit Diagrams

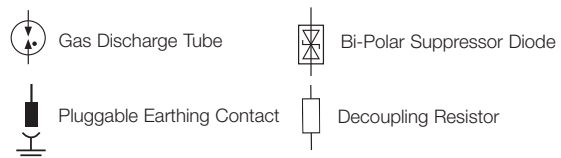
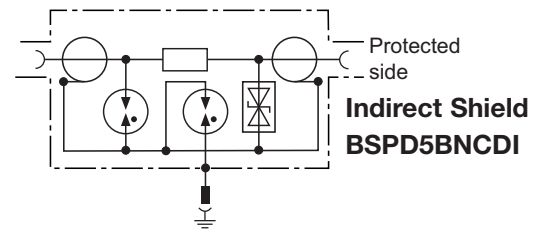
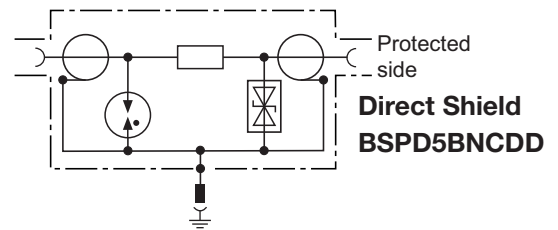

Technical Data		
Catalog Number	BSPD5BNCDD	BSPD5BNCDI
Return loss at 300MHz	≥8dB	≥10dB
Capacitance shield-PG (C)	—	≤20pF
Voltage protection level shield-PG for I _n C2 (U _p)	—	≤650V
Voltage protection level shield-PG at 1kV/μs C3 (U _p)	—	≤600V
Nominal voltage (U _N)	5V	
Max. continuous operating DC voltage (U _C)	6.4V	
Nominal current (I _L)	0.1A	
C2 Nominal discharge current (8/20μs) shield-PG (I _n)	10kA	
C2 Nominal discharge current (8/20μs) line-shield (I _n)	5kA	
Voltage protection level line-shield for I _n C2 (U _p)	≤35V	
Voltage protection level line-shield at 1kV/μs C3 (U _p)	≤13V	
Frequency range	0-300MHz	
Insertion loss at 160MHz	≤0.4dB	
Insertion loss at 300MHz	≤3dB	
Return loss at 130MHz	≥20dB	
Impedance (Z)	50Ω	
Series impedance per line	4.7Ω	
Capacitance line-shield (C)	≤25pF	
Operating temperature range	-40°C to +80°C	
Degree of protection	IP10	
For mounting on	35mm DIN-Rails per EN 60715	
Connection (input / output)	BNC Socket (female) / BNC Socket (female)	
Grounding	Via 35mm DIN-Rail per EN 60715	
Enclosure material	Zinc die casting	
Color	Bare surface	
Test standards	IEC 61643-21 / EN 61643-21	
Agency Information	UL 497B	
Warranty	5 Years*	

* See Bussmann SPD Limited Warranty Statement (3A1502) for details at www.cooperbussmann.com/Surge.



DIN-Rail BNC SPD Applications

Part Numbers	BSPD5BNCDD	BSPD5BNCDI
Bus Systems and Measuring, and Control Technology		
Control Net	X	X
Melsec Net 2	X	X
N1 LAN	X	X
Data Networks		
Arcnet	X	X
Video Systems		
Video (coax)	X	X

Direct vs. Indirect Shielding - Application Example

Apply the BSPD5BNCDD (direct shield) at the equipment location and apply the BSPD5BNCDI (indirect shield) near exterior protected equipment. The indirect shield grounding at the exterior device will help avoid picking up leakage currents that can degrade signal quality while providing surge protection when needed. See illustration below for installation locations.

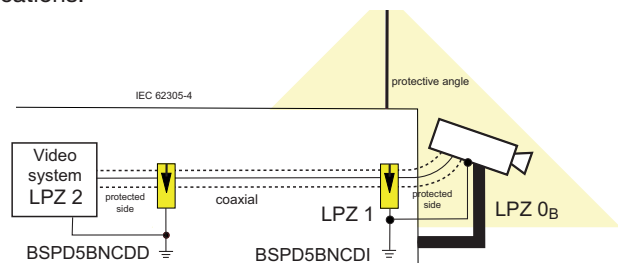

Surge Protection Made Simple™ for Coaxial Data Cables

UL Listed 497B In-line Surge Protective Device for BNC Connector Cable Systems



Description

The Bussmann BSPD5BNCSI two-stage in-line surge arrester is for protecting coaxial cable-connected systems (such as video and camera systems) from potential damage.

The BSPD5BNCSI shielded surge arrester is plugged into coaxial terminal equipment or connections. Common applications include protecting outdoor video surveillance systems or video control centers. The cable shield is indirectly grounded via a gas discharge tube to avoid being influenced by leakage pickups. The arrester input is used as a socket and the protected output as a plug.

- UL 497B Listed
- Plug-in surge protective device for easy retrofitting
- Directly plugs into terminal equipment with BNC coaxial connections
- Integrated indirect shield grounding avoids leakage pickups

BSPD5BNCSI



Dimensions-mm

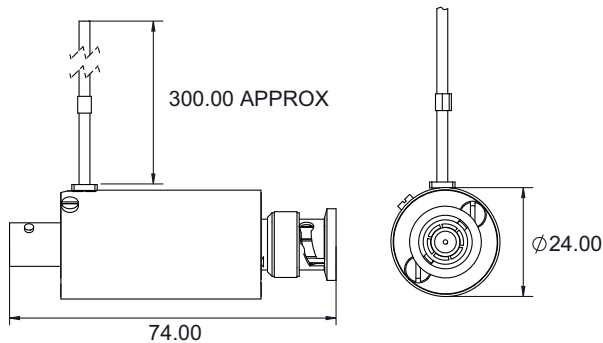

In-line SPD for BNC Coax

Circuit Diagram

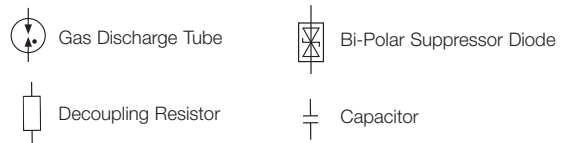
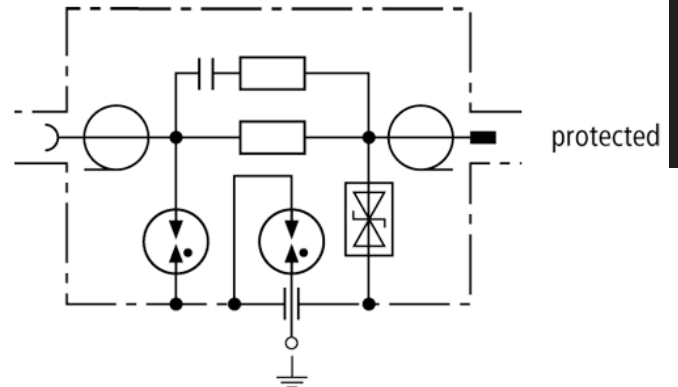

Surge Protection Devices

TECHNICAL DATA	
Catalog Number	BSPD5BNCSI
Nominal voltage (U_N)	5V
Max. continuous operating DC voltage (U_C)	8V
C2 Nominal discharge current (8/20 μ s) per line (I_n)	2.5kA
C2 Nominal discharge current (8/20 μ s) shield-PG (I_n)	10kA
Voltage protection level line-shield for I_n C2 (U_p)	$\leq 25V$
Voltage protection level line-shield at 1kV/ μ s C3 (U_p)	$\leq 15V$
Voltage protection level shield-PG at 1kV/ μ s C3 (U_p)	$\leq 600V$
Insertion loss at 265MHz	$\leq 3dB$
Return loss at 40MHz	$\geq 20dB$
Impedance (Z)	75 Ω
Series impedance per line	10 Ω
Capacitance line-shield (C)	$\leq 50pF$
Operating temperature range	-40°C to +80°C
Connection (input / output)	BNC Socket (female) / BNC Plug (male)
Grounding	Via outgoing earth conductor 18AWG (0.75mm ²)
Shield grounding	Indirectly via an integrated spark gap element
Test standards	IEC 61643-21 / EN 61643-21
Agency information	UL 497B
Warranty	5 Years*

* See Bussmann SPD Limited Warranty Statement (3A1502) for details at www.cooperbussmann.com/Surge.

In-line BNC SPD Applications

Part Number	BSPD5BNCSI
Bus Systems and Measuring & Control Technology	
Control Net	X
Melsec Net 2	X
Data Networks	
Arcnet	X
Video Systems	
Video (coax)	X



Surge Protection Made Simple™ for Ethernet Data Cables

UL Listed 497B Universal DIN-Rail Mount Surge Protective Device for RJ45/Ethernet Cable Systems



Description

The Bussmann DIN-Rail mount BSPD48RJ45 Surge Protective Device (SPD) for Ethernet cable systems with RJ connectors is easy to install in new, or retrofitting into existing, installations.

The BSPD48RJ45 is installed between the patch panel and the active component (a switch for example). The snap-in mechanism of the supporting foot allows the SPD to be safely grounded via the DIN-Rail. For single applications, the BSPD48RJ45 comes with a supplied mounting bracket with cable lug.

Fulfilling the requirements of Category 6, the BSPD48RJ45 can be universally used for all data services up to nominal voltages of 48V. It is well suited for existing services such as Gigabit Ethernet, ATM, ISDN, Voice over IP and Power over Ethernet (PoE+ acc. to IEEE 802.3at up to 57V) and similar applications in structured cabling systems according to Class E up to 250MHz. Protection of all pairs by means of powerful gas discharge tubes and one adapter filter matrix per pair.

- UL 497B Listed
- Easy to install or retrofit for protection of all lines
- CAT 6 according to ISO/IEC 11801
- CAT 6 in the channel (Class E)
- Power over Ethernet (PoE+ according to IEEE 802.3at)

Dimensions -mm

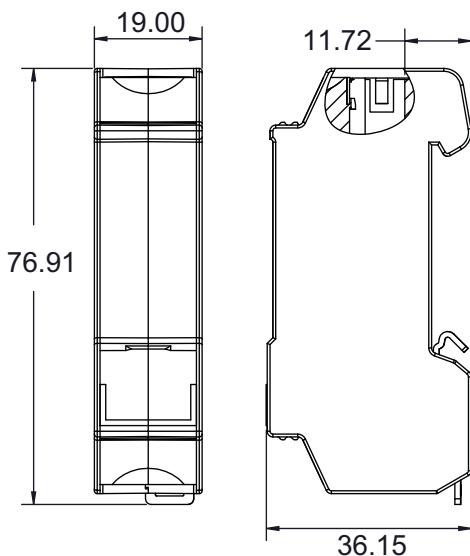

BSPD48RJ45



DIN-Rail Mount SPD for RJ45 / Ethernet Connection

Circuit Diagram

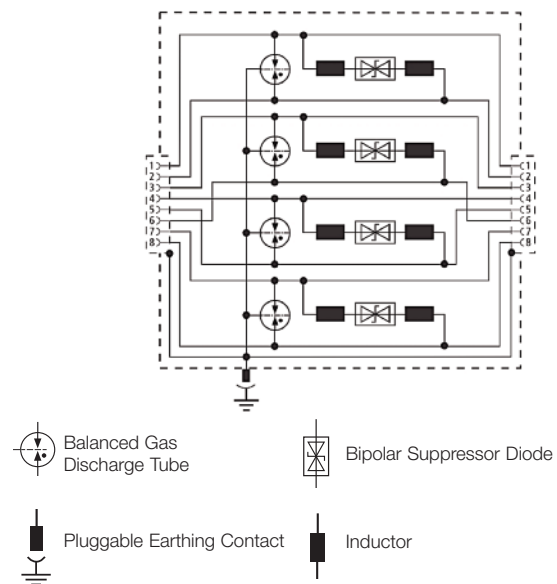

Surge Protection
Devices

TECHNICAL DATA	
Catalog Number	BSPD48RJ45
Nominal voltage (U _N)	48V
Max. continuous operating DC voltage (U _C)	48V
Max. continuous operating AC voltage (U _C)	34V
Max. continuous DC voltage pair-pair (PoE) (U _C)	57V
Nominal current (I _N)	1A
C2 Nominal discharge current (8/20μs) line-line (I _n)	150A
C2 Nominal discharge current (8/20μs) line-PG (I _n)	2.5kA
C2 Total nominal discharge current (8/20μs) line-PG (I _n)	10kA
C2 nominal discharge current (8/20μs) pair-pair (PoE) (I _n)	150A
Voltage protection level line-line for I _n C2 (U _P)	≤190V
Voltage protection level line-PG for I _n C2 (U _P)	≤600V
Voltage protection level line-line for I _n C2 (PoE) (U _P)	≤600V
Voltage protection level line-line at 1kV/μs C3 (U _P)	≤180V
Voltage protection level line-PG at 1kV/μs C3 (U _P)	≤500V
Voltage protection level pair-pair at 1kV/μs C3 (PoE) (U _P)	≤600V
Insertion loss at 250MHz	≤3dB
Capacitance line-line (C)	≤30pF
Capacitance line-PG (C)	≤25pF
Operating temperature range	-40°C to +80°C
Degree of protection	IP10
For mounting on	35mm DIN-Rails per EN 60715
Connection (input / output)	RJ45 socket / RJ45 socket
Pinning	1 / 2, 3 / 6, 4 / 5, 7 / 8
Grounding	Via 35mm DIN-Rails per EN 60715
Enclosure material	Zinc die casting
Color	Bare surface
Test standards	IEC 61643-21 / EN 61643-21
Agency information	UL 497B
Warranty	5 Years*

* See Bussmann SPD Limited Warranty Statement (3A1502) for details at www.cooperbussmann.com/Surge.

DIN-Rail RJ45 SPDs Applications

Part Number	BSPD48RJ45
Bus systems and Measuring, and Control Technology	
Industrial Ethernet	X
Data Networks	
ATM	X
Ethernet 10/100/1000	X
FDDI, CDDI	X
Industrial Ethernet	X
Power over Ethernet (PoE)	X
Token Ring	X
VG Any LAN	X
Video Systems	
Video (2 wire)	X



Surge Protection Made Simple™ for Twisted Pair Data Cables UL Listed 497B DIN-Rail Mount Universal Surge Protective Device for Measuring and Control Circuits, and Bus Systems



Description

The Bussmann universal four-pole, DIN-Rail mounted surge arresters provide effective protection with minimum space requirements and are designed for stringent requirements on the availability of measuring and control circuits, and bus systems.

To ensure safe operation, the arresters provide protection against vibration and shock up to a 30-fold acceleration of gravity. The function-optimized design of the devices allows quick and easy removal of protection modules via “make-before-break” terminals that assure continuity of data signals in the protected and unprotected state.

For IEC Applications - Instruction for Surge Protective Device Use In Zone 2 Explosive Atmospheres per ATEX.

- When installed in potentially explosive atmospheres, the Data Signal DIN Series shall be installed into an enclosure which meets the requirements of a recognized type of protection, in accordance with EN 60079-0.
- The Data Signal DIN Series as transient suppressor. This approval applies to the following equipment types:
 - BSPD5DING • BSPD12DING • BSPD24DING
 - BSPD48DING • BSPD5DINLHF • BSPD24DINLHF

Ambient and Temperature Class

- -40°C to +80°C, T4:
DEKRA 12ATEX0254 X: II 3 G Ex nA IIC T4 Gc
- Standards used for:
ATEX: EN60079-0: 2009, EN 60079-15: 2005
- UL 497B Listed
- Function-optimized design for safe use and easy installation
- Four-pole and base mounts on grounded 35mm DIN-Rail
- Module removal without signal interruption via “make-before-break” circuitry
- 0-180V BSPD0180DINL automatically adjusts to system operating voltage and can protect data circuits of different voltages up to 100mA load current.

Dimensions-mm

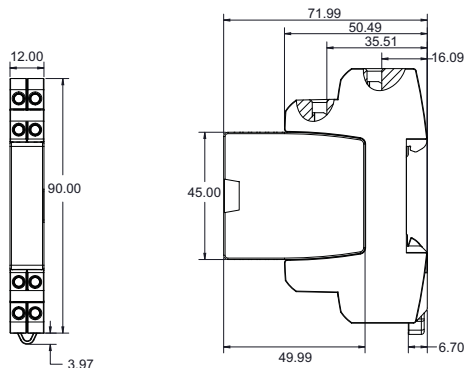

- BSPD5DING**
- BSPD12DING**
- BSPD24DING**
- BSPD48DING**
- BSPD5DINLHF**
- BSPD24DINLHF**
- BSPD0180DINL**



Four-Pole DIN-Rail Mount Universal SPD for Data Signal Applications

Circuit Diagrams

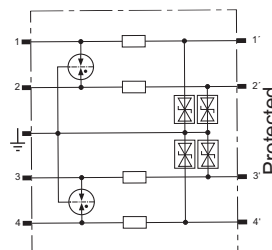

BSPD5DING
BSPD12DING
BSPD24DING
BSPD48DING

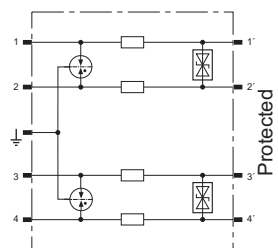

BSPD5DINLHF
BSPD24DINLHF

BSPD0180DINL

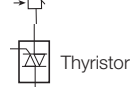
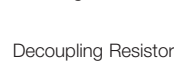

Surge Protection Devices

TECHNICAL DATA							
Catalog number — Prefix: BSPD...	...5DING	...12DING	...24DING	...48DING	...5DINLHF	...24DINLHF	...0180DINL
Nominal voltage (U_N)	5V	12V	24V	48V	5V	24V	0-180V
Nominal current at 45°C (I_L)	1.0A	0.75A	0.75A	0.75A	1.0A	1.0A	≤0.1A@80°C
VPL line-line for I_{imp} D1 (U_p)	≤29V	≤50V	≤102V	≤160V	≤25V	≤65V	≤ $U_N + 53V$
VPL line-PG for I_{imp} D1 (U_p)	≤27V	≤37V	≤66V	≤95V	≤550V	≤550V	-
VPL line-line at 1kV/μs C3 (U_p)	≤18V	≤38V	≤90V	≤140V	≤11V	≤47V	see Note 1
VPL line-PG at 1kV/μs C3 (U_p)	≤9V	≤19V	≤45V	≤70V	≤550V	≤550V	-
VPL line-line for I_n C2 (U_p)	-	-	-	-	-	-	see Note 2
VPL line-PG for C2 / C3 / D1	-	-	-	-	-	-	≤ 550V
D1 Total lightning impulse current (10/350μs) (I_{imp})	10kA	10kA	10kA	10kA	10kA	10kA	10kA
D1 Lightning impulse current (10/350μs) per line (I_{imp})	2.5kA	2.5kA	2.5kA	2.5kA	2.5kA	2.5kA	2.5kA
C2 Total nominal discharge current (8/20μs) (I_n)	20kA	20kA	20kA	20kA	20kA	20kA	20kA
C2 Nominal discharge current (8/20μs) per line (I_n)	10kA	10kA	10kA	10kA	10kA	10kA	10kA
Series impedance per line	1.0Ω	1.8Ω	1.8Ω	1.8Ω	1.0Ω	1.0Ω	10Ω/7.5Ω typ
Frequency of the operating voltage (f_{U_N})	-	-	-	-	-	-	0-400Hz
Max. continuous operating DC voltage (U_C)	6V	15V	33V	54V	6V	33V	180V
Max. continuous operating AC voltage (U_C)	4.2V	10.6V	23.3V	38.1V	4.2V	23.3V	127V
Permissible superimposed signal voltage (U_{Signal})							± 5V
"Nominal current at 80°C (I_L) (corresponds to max. short-circuit current)"	-	-	-	-	-	-	100mA
Cut-off frequency line-PG (f_G)	1.0MHz	2.7MHz	6.8MHz	8.7MHz	100MHz	100MHz	-
Cut-off frequency line-line (U_{Signal} , balanced 100Ω) (f_G)	-	-	-	-	-	-	50MHz
Capacitance line-line (C)	≤2.7nF	≤1.0nF	≤0.5nF	≤0.35nF	≤25pF	≤25pF	≤80pF
Capacitance line-PG (C)	≤5.4nF	≤2.0nF	≤1.0nF	≤0.7nF	≤16pF	≤16pF	≤16pF
ATEX Approvals	†	†	†	†	†	†	-
Agency information	††	††	††	††	††	††	‡
IEC 61643-21 Test category	D1, C2, C3						
Operating temperature range	-40°C to +80°C						
Degree of protection	IP20						
For mounting on	35mm DIN-Rails per EN 60715						
Grounding	Via base part						
Color / enclosure material	Grey / Polyamide PA 6.6						
Test standards	IEC 61643-21 / EN 61643-21, UL 497B						
Connection (input / output)	Screw terminal						
Conductors	Solid	12-28AWG (4-0.08mm ²)					
	Flexible	14-28AWG (2.5-0.08mm ²)					
Terminal torque	3.5 Lb-In (0.4 N•m)						
Warranty	5 Years*						

* See Bussmann SPD Limited Warranty Statement (3A1502) for details at www.cooperbussmann.com/surge.

0-180V SPD Application and Mode of Operation

The BSPD0180DINL surge protective device automatically adjusts to the operating voltage (from 0 to 180 volts) of the protected device.

When an overvoltage event occurs, the SPD voltage protection level adjusts itself based upon the output terminal operating voltage of the base.

Note 1 - See Diagram 1 - VPL line-line graph line C3.

Note 2 - See Diagram 1 - VPL line-line graph line C2.

† DEKRA 12ATEX0254 X: II 3 G Ex nA IIC T4 Gc

†† ATEX, UL, CSA

‡ UL 497B

Diagram 1: Voltage Protection Level U_p (V) (Line - Line)

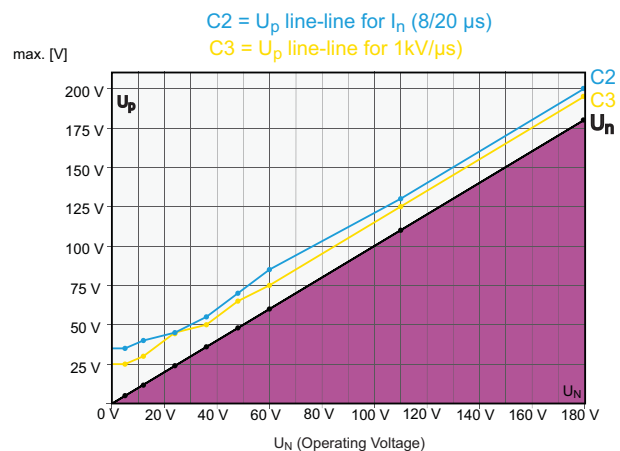

DIN-Rail Universal 4 Wire Data Signal SPDs and Applications

Universal 4 wire data signal SPD products are specified by communication technology. The table below contains the specific SPD product, by part number, and the applications to which they are suited to be used.



Part Numbers	BSPD5DING	BSPD12DING	BSPD24DING	BSPD48DING	BSPD5DINLHF	BSPD24DINLHF	BSPD0180DINL
BUS SYSTEMS AND MEASURING, AND CONTROL TECHNOLOGY							
0-20 mA, 4-20 mA Signals			X			X (4-20mA only)	X
Binary Signals	X	X	X	X			
CAN-Bus (data line only)					X		X
C-Bus (Honeywell)					X		X
Data Highway Plus							X
Device Net (data line only)					X		X
Dupline							X
E-Bus (Honeywell)							X
Fieldbus Foundation						X	X
FIPIO / FIPWAY						X	
FSK					X		X
IEC-Bus (RS485)					X		X
Interbus INLINE (I/O)							X
Interbus INLINE, Long-distance bus					X		X
K Bus						X	
LON - TP/XF 78					X		
LUXMATE Bus						X	X
M Bus							X
MODBUS					X		X
MPI Bus					X		X
Procontic CS31 (RS232)		X					
Procontic T200 (RS422)					X		X
PROFIBUS DP/FMS					X		X
PROFIBUS PA						X	X
PROFIBUS SIMATIC NET					X		X
PSM EG RS422 & RS485					X		X
Rackbus (RS485)					X		X
R Bus					X		X
RS 485					X		X
RS422, V11					X		X
SafetyBUS p					X		X
Securilan LON Bus					X		
SIGMASYS				X			
SS97 SIN/X (RS 232)		X					
SUCONET					X		X
Resistance Temp. Measuring Ni1000, PT100, PT1000 Wire NTC & PTC Thermistors		X					
TTL		X					
TTY 4-20mA			X				
TELECOMMUNICATION, TELEPHONY							
a/b Wires							X
ADSL, ADSL 2+							X
ISDN S ₀ , S _{2m} /U _{2m} , U _{KO} /U _{PO}							X
Modem M1		X					
SDSL, SHDSL						X	X
Telephony Systems (e.g., Siemens, HICOM, Alcatel)							X
T-DSL							X
Telecommunication Systems (e.g., Siemens, HICOM, Alcatel)							X
VDSL							X
DATA NETWORKS							
V 24 (RS232 C)		X					

SurgePOD™ Series

Surge Protective Overvoltage Device Modules



Description

Bussmann SurgePOD surge protective overvoltage device modules are board-mounted. Upon an overvoltage condition, their voltage clamping feature becomes conductive, safely shunting the surge to ground.

All SurgePOD devices are UL 1449 3rd Edition Recognized Type 1 SPD and contain an internal element that safely disconnects the device upon reaching an overvoltage breakdown condition.

Remote contact signaling is accomplished with an optional *Normally Open* microswitch that closes upon reaching an overvoltage breakdown condition.

Local visual indication is accomplished with optional visual indicating tabs that protrude through the device's top upon reaching an overvoltage breakdown condition.

The SurgePOD's MOV substrate material may be damaged by excessive shock or rough handling. To ensure integrity of finished device, do NOT install any SurgePOD devices that are dropped or abused during assembly.

Suitability of SurgePOD devices for application to be determined by end user.



Catalog Number System:

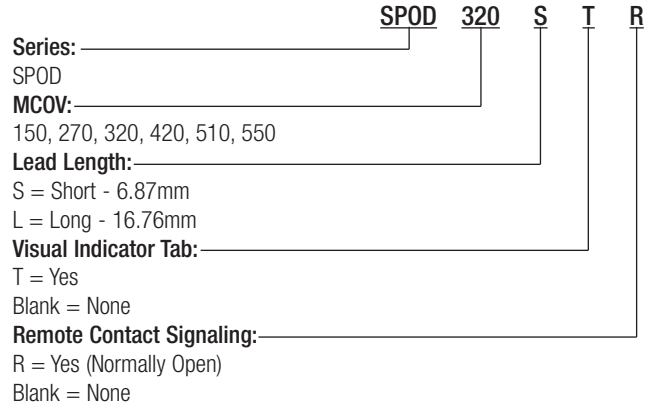

Agency Information

UL 1449 3rd Edition Recognized Type 1 Surge Protective Device; File E340782.

Electrical Specifications

Maximum Continuous Operating Voltage (MCOV)	150Vac to 550Vac
Short-Circuit Current Rating (SCCR)	200kA
Nominal Discharge Current (I _n) 8/20ms	20kA
Max Discharge Current Rating (I _{max}) 8/20ms	50kA
Remote Contact Signaling Microswitch	20mA@15Vdc



SurgePOD Specifications	Voltage / Color Code					
	150V	270V	320V	420V	510V	550V
I _n	20kA	20kA	20kA	20kA	20kA	20kA
I _{max}	50kA	50kA	50kA	50kA	50kA	50kA
SCCR	200kA	200kA	200kA	200kA	200kA	200kA
MCOV (V _{rms})	150V	270V	320V	420V	510V	550V
VPR	600V	900V	1200V	1500V	1500V	1500V
Nominal V _{rms} *	120V	220V	277V	347V	480V	480V

* Nominal V_{rms} @ 50/60Hz.

Data Sheet: 1170

SurgePOD™ Series

Mechanical Specifications

All components are rated IP20 finger-safe in the installed state.

Environmental Specifications

- Plastic Material: Polybutylene Terephthalate
- Flammability Rating: UL 94V0
- Storage Temperature: -25°C to 85°C
- Operating Temperature: -25°C to 85°C

Local Visual Indication Tabs (Optional)

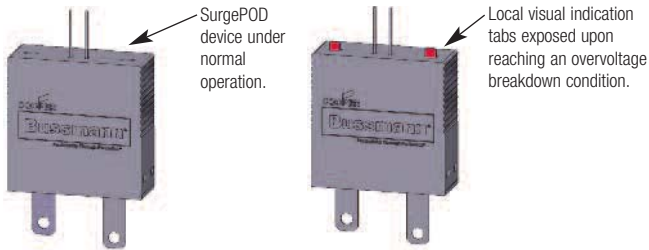

Dimensions - in [mm]

Tolerance is ± 0.005" [0.13mm] unless otherwise stated.

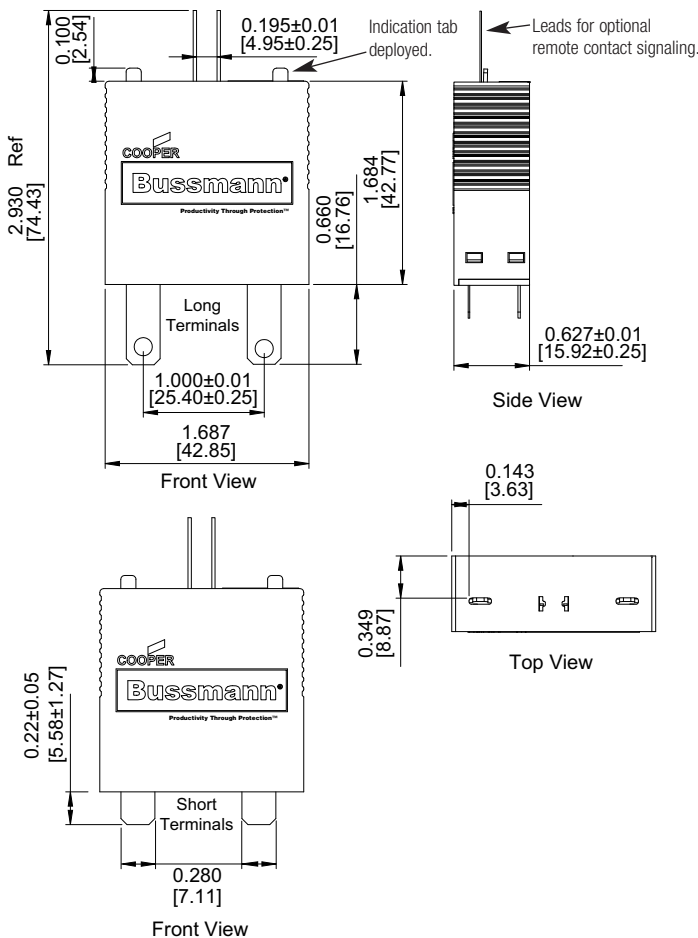

Terminal Dimensions / Pad Layout - in [mm]

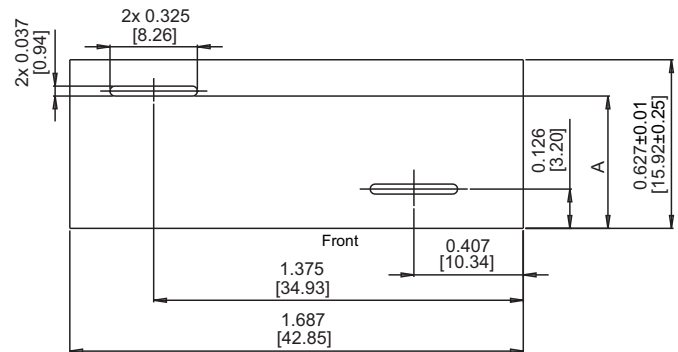

Dimension A		
MCOV Rating	Inches	mm
150	0.431	10.95
270, 320	0.479	12.17
420, 510, 550	0.526	13.36

Terminal Information and Mounting

The SurgePOD surge protective overvoltage devices have nickel-plated copper terminals for easy solder connection to printed circuit boards.

Recommended Pad Layout for Remote Contact Signaling - in [mm]

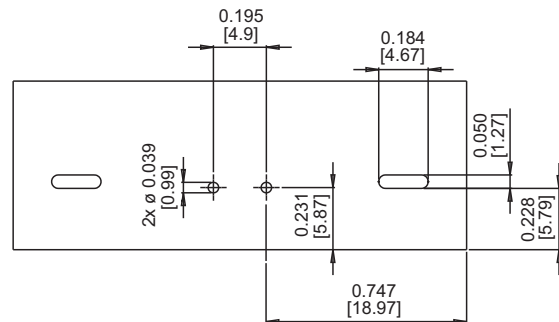

Packaging Information

- 200 units per master pack

DIN-Rail TVS Series

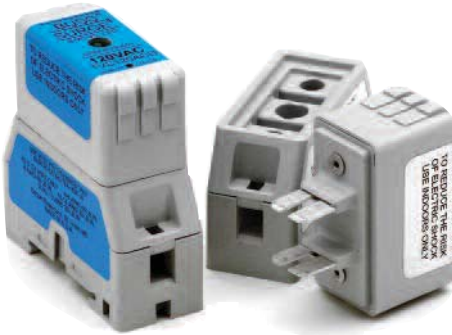

Status LED

OFF - Suppressor Non-Operational (power may be on)
GREEN - Suppressor Operational (power on)

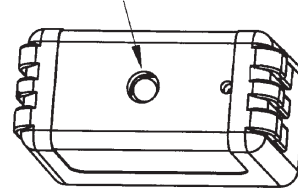

Specifications

Description: DIN-Rail mount voltage surge protection system for AC or DC voltage using diode or MOV technology.

Construction:

- Suppressor:** Case: 20% glass filled PES (Polyethersulfone)
Terminals: 110 Copper
Terminal Plating: Electroless tin
- Holder:** Case: 15% glass filled PBT (Polybutylene Terephthalate)
Interface Clips: CDA 7025
Interface Clip Plating: Electroless tin
Contact Lubricant: Fluoroether grease
Box Lug: Copper
DIN-Rail Springs: Stainless steel

Ratings*:

- Volts: — 12Vdc (2kA surge current)
- 24Vdc (2kA surge current)
- 48Vdc (2kA surge current)
- 120Vac (7kA-18kA surge current)
- 240Vac (7kA-18kA surge current)

* See Catalog Numbers table for all specifications pertaining to specific voltage ratings.

Agency Information: UL Recognized (UL 1449) for AC products, (UL 497B) for DC products, CSA Approved.

Dimensions - in

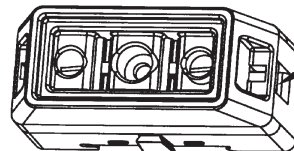
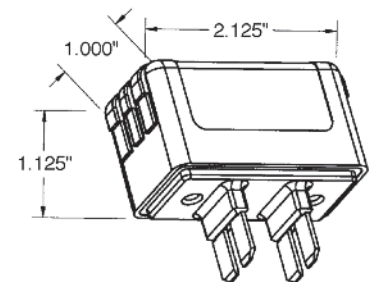

Power Terminals
14AWG - 4AWG
Dual 10AWG

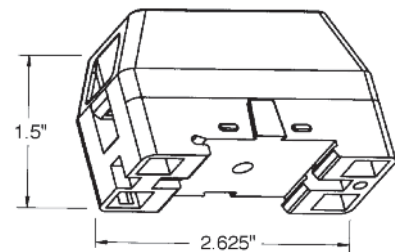

Product Specifications:

1. All TVS devices have non-polarized electrical connections as shown.
2. Suppressor voltage characteristics per chart.
3. Suppressor to provide non-interrupted service.
4. Enclosure material is 94V0 flame and explosion resistant.
5. Product markings show manufacturer, part number and safety warnings as required.
6. Mechanical dimensions as noted.
7. Suppressor Status LED as shown.
8. AC units operate on either 50 or 60Hz.

Catalog Numbers

Catalog Numbers	Voltage Application	MCOV	Technology	SVR 500A, 8x20µs	Surge Current Rating	Agency Information	Label Color
TVS12DCD	12Vdc	14Vdc	SASD	36Vdc	2kA	UL 497B	Red
TVS24DCD	24Vdc	28Vdc	SASD	58Vdc	2kA	UL 497B	White
TVS48DCD	48Vdc	57Vdc	SASD	90Vdc	2kA	UL 497B	Black
TVS120ACD	120Vac	140Vac	SASD	330Vac	7kA	UL 1449	Blue
TVS120ACM	120Vac	140Vac	MOV	500Vac	18kA	UL 1449	Grey
TVS240ACD	240Vac	280Vac	SASD	600Vac	7kA	UL 1449	Blue
TVS240ACM	240Vac	280Vac	MOV	800Vac	18kA	UL 1449	Grey

Data Sheet: 9006

Reduce Downtime With Quick Access to the Right Replacement Fuse

Section Contents	Page
Fuse Service Kits	
Supplemental	506-507
Branch circuit	506-507
Premium branch circuit	506-507
Large electronic	508
Small electronic	508
Electrical & electronic	508
Clips clamps & rail adapters (DIN & American)	509
Spare fuse holders, pullers, testers & cabinets	
Telepower spare fuse holders	510
5TPH	510
Fuse pullers	510
FT-2 & FT-3 fuse testers	510
SFC spare fuse cabinet	510
Fuse reducers & dummy "neutrals"	
Class J fuses - LPJ, JKS	511
Class R fuses - FRN-R, LPN-RK, FRS-R & LPS-RK	511
Class H & K fuses - NON, REN, NOS & RES	511
Dummy fuse "neutrals"	511



Fuse Service Kits

Save Time and Money with These Fuse Service Kits

Selection

These service kits are filled with the most common fuse types and sizes for the most common applications – no need to search for the right fuse, it's in the kit.

Organization

The compact and sturdy carrying case allows organizing and modifying the fuses needed to assure a proper supply is kept on hand.

Accessories

All kits come with a fuse puller for the fuses it contains. As a bonus, all kits on this page include a free wire stripper or lineman's pliers.

Supplemental



Glass Fuse Kit

Catalog Number: GSK-260

Kit Contents

- | | | |
|---------------|------------|-------------|
| (5) GMA-500mA | (5) MDL-6 | (5) AGC-10 |
| (5) GMA-1A | (5) MDL-7 | (5) AGC-15 |
| (5) GMA-2A | (5) MDL-8 | (5) AGC-20 |
| (5) GMA-3A | (5) MDL-10 | (5) GMC-2A |
| (5) GMA-4A | (5) MDL-15 | (5) GMC-5A |
| (5) GMA-5A | (5) MDL-20 | (5) GMC-10A |
| (5) GMA-6A | (5) AGC-¼ | (5) MDA-5 |
| (5) GMA-10A | (5) AGC-½ | (5) MDA-10 |
| (5) GMA-15A | (5) AGC-1 | (5) MDA-12 |
| (5) MDL-¼ | (5) AGC-1½ | (5) MDA-15 |
| (5) MDL-½ | (5) AGC-2 | (5) MDA-20 |
| (5) MDL-1 | (5) AGC-2½ | (5) ABC-5 |
| (5) MDL-1½ | (5) AGC-3 | (5) ABC-10 |
| (5) MDL-2 | (5) AGC-4 | (5) ABC-12 |
| (5) MDL-2½ | (5) AGC-5 | (5) ABC-15 |
| (5) MDL-3 | (5) AGC-6 | (5) ABC-20 |
| (5) MDL-4 | (5) AGC-7 | |
| (5) MDL-5 | (5) AGC-8 | |
- (1) FT-3 Fuse tester/puller
(1) 6-inch Crescent® wire stripper



Midget Fuse Kit

Catalog Number: MSK-45

Kit Contents

- | | |
|------------|-----------------------------|
| (3) FNM-1 | (3) KTK-20 |
| (3) FNM-2 | (3) KTK-30 |
| (3) FNM-5 | (3) FNQ-5 |
| (3) FNM-10 | (3) FNQ-10 |
| (3) FNM-15 | (3) FNQ-15 |
| (3) KTK-5 | (3) FNQ-20 |
| (3) KTK-10 | (3) FNQ-30 |
| (3) KTK-15 | (1) FT-3 Fuse tester/puller |
- (1) 6-inch Crescent® wire stripper

Branch Circuit



Class CC Fuse Kit

Catalog Number: CCSK-45

Kit Contents

- | | |
|--------------|--------------|
| (3) LP-CC-5 | (3) KTK-R-15 |
| (3) LP-CC-10 | (3) KTK-R-20 |
| (3) LP-CC-15 | (3) KTK-R-30 |
| (3) LP-CC-20 | (3) FNQ-R-½ |
| (3) LP-CC-30 | (3) FNQ-R-3 |
| (3) KTK-R-5 | (3) FNQ-R-5 |
| (3) KTK-R-10 | (3) FNQ-R-10 |
- (1) FT-3 Fuse tester/puller
(1) 6-inch Crescent® wire stripper



Fusetron™ Class RK5 250/600V Fuse Kit

Catalog Number: RK5SK-39

Kit Contents

- | | |
|---------------|----------------------|
| (3) FRN-R-10 | (3) FRS-R-10 |
| (3) FRN-R-15 | (3) FRS-R-15 |
| (3) FRN-R-20 | (3) FRS-R-20 |
| (3) FRN-R-25 | (3) FRS-R-30 |
| (3) FRN-R-30 | (3) FRS-R-60 |
| (3) FRN-R-60 | (3) FRS-R-100 |
| (3) FRN-R-100 | (1) FP-2 Fuse puller |
- (1) NO.263-R (60 to 30A fuse reducer)
(1) NO.663-R (60 to 30A fuse reducer)
(1) 6-inch Crescent® wire stripper

Premium Branch Circuit



Low-Peak™ Class RK1 250/600V Fuse Kit

Catalog Number: RK1SK-39

Kit Contents

- | | |
|-----------------|------------------|
| (3) LPN-RK-10SP | (3) LPS-RK-10SP |
| (3) LPN-RK-15SP | (3) LPS-RK-15SP |
| (3) LPN-RK-20SP | (3) LPS-RK-20SP |
| (3) LPN-RK-25SP | (3) LPS-RK-30SP |
| (3) LPN-RK-30SP | (3) LPS-RK-60SP |
| (3) LPN-RK-60SP | (3) LPS-RK-100SP |
- (3) LPN-RK-100SP
(1) NO.263-R (60 to 30A fuse reducer)
(1) NO.663-R (60 to 30A fuse reducer)
(1) FP-2 Fuse puller
(1) 8½-inch Crescent® lineman's pliers



Low-Peak™ Class J Fuse Kit

Catalog Number: JSK-36

Kit Contents

- | | |
|--------------|---------------|
| (3) LPJ-3SP | (3) LPJ-25SP |
| (3) LPJ-5SP | (3) LPJ-30SP |
| (3) LPJ-6SP | (3) LPJ-40SP |
| (3) LPJ-10SP | (3) LPJ-50SP |
| (3) LPJ-15SP | (3) LPJ-60SP |
| (3) LPJ-20SP | (3) LPJ-100SP |
- (1) FP-2 Fuse puller
(1) 8½-inch Crescent® lineman's pliers

Fuse Service Kits

Supplemental/Branch Circuit



Class CC / Midget Fuse Kit

Emergency fuse kit for replacement of 1³/₃₂" x 1¹/₂" (Class CC and midget) fuses in a sturdy nylon box. Cross reference makes it easy to install the correct fuse in any Class CC or midget application.

Kit Size: 10⁷/₁₆" W x 6⁵/₁₆" D x 1³/₄" H

Catalog Number: NO.36

Emergency Kit Contents

- | | |
|--------------------------|--------------|
| (2) FNQ-R- $\frac{1}{2}$ | (2) KTK-R-1 |
| (2) FNQ-R-1 | (2) KTK-R-2 |
| (2) FNQ-R-2 | (2) KTK-R-3 |
| (2) FNQ-R-3 | (2) KTK-R-5 |
| (2) FNQ-R-4 | (2) KTK-R-6 |
| (2) FNQ-R-5 | (2) KTK-R-10 |
| (2) FNQ-10 | (2) KTK-R-15 |
| (2) FNQ-15 | (2) KTK-R-20 |
| (2) FNQ-20 | (2) KTK-R-30 |
| (1) FP-2 Fuse puller | |

Branch Circuit



Fusetron™ Class RK5 250V Fuse Kit

Compact kit in a sturdy nylon box rugged enough to withstand field use. Extra spaces and changeable compartments make it easy to customize for your particular need.

Catalog Number: ERK-28

Service Kit Contents

- | | |
|-----------------------------|-----------------------|
| (2) FRN-R-3- $\frac{3}{16}$ | (2) FRN-R-40 |
| (2) FRN-R-6- $\frac{1}{4}$ | (2) FRN-R-50 |
| (2) FRN-R-10 | (3) FRN-R-60 |
| (2) FRN-R-15 | (2) FRN-R-100 |
| (3) FRN-R-20 | (2) NO.263-R Reducers |
| (2) FRN-R-25 | (2) NO.1 Clip Clamps |
| (4) FRN-R-30 | (2) NO.2 Clip Clamps |
| (2) FRN-R-35 | |

Premium Branch Circuit



Low-Peak™ Class RK1 250V Fuse Kit

Compact kit in a sturdy nylon box rugged enough to withstand field use. Extra spaces and changeable compartments make it easy to customize for your particular need.

Catalog Number: LPRK-28

Service Kit Contents

- | | |
|---------------------------------|-----------------------|
| (2) LPN-RK-3- $\frac{3}{16}$ SP | (2) LPN-RK-40SP |
| (2) LPN-RK-6- $\frac{1}{4}$ SP | (2) LPN-RK-50SP |
| (2) LPN-RK-10SP | (3) LPN-RK-60SP |
| (2) LPN-RK-15SP | (2) LPN-RK-100SP |
| (3) LPN-RK-20SP | (2) NO.263-R Reducers |
| (2) LPN-RK-25SP | (2) NO.1 Clip Clamps |
| (4) LPN-RK-30SP | (2) NO.2 Clip Clamps |
| (2) LPN-RK-35SP | (1) FP-2 Fuse puller |

Fuse Service Kits

Large Electronic Fuse Kit



Fuse Kit 270

Small dimension fuse assortment with 270 fuses, fuse holders, fuse blocks and fuse clips to fit most electronic equipment.

Ratings:

Volts: — 125V/250V

Catalog Number: NO.270

Assortment Contents

- | | | |
|--------------------------|--------------------------|--------------------------|
| (5) MDL- $\frac{1}{2}$ | (5) AGC- $\frac{1}{2}$ | (5) GMA-1A |
| (5) MDL- $\frac{3}{4}$ | (5) AGC- $\frac{3}{4}$ | (5) GMA-2A |
| (5) MDL-1 | (5) AGC-1 | (5) GMA-3A |
| (5) MDL- $\frac{3}{4}$ | (5) AGC-1- $\frac{1}{2}$ | (5) GMA-4A |
| (5) MDL-1 | (5) AGC-2 | (5) GMA-6A |
| (5) MDL-1- $\frac{1}{2}$ | (5) AGC-2- $\frac{1}{2}$ | (5) GMC-1A |
| (5) MDL-2 | (5) AGC-3 | (5) GMC-2A |
| (5) MDL-3 | (5) AGC-4 | (5) GMC-3A |
| (5) MDL-4 | (5) AGC-5 | (5) GMC-4A |
| (5) MDL-5 | (5) AGC-6 | (5) GMC-6A |
| (5) MDL-6 | (5) AGC-7 | (4) AGC-V- $\frac{1}{2}$ |
| (5) MDA-8 | (5) AGC-8 | (4) AGC-V-1 |
| (5) MDA-10 | (5) ABC-10 | (4) AGC-V-2 |
| (5) MDA-15 | (5) ABC-15 | (4) AGC-V-3 |
| (5) MDA-20 | (5) ABC-20 | (4) MDL-V- $\frac{1}{2}$ |
| (5) MDA-30 | (5) ABC-30 | (4) MDL-V-1 |
| (5) AGC- $\frac{1}{2}$ | (5) GMA-250mA | (4) MDL-V-2 |
| (5) AGC- $\frac{3}{4}$ | (5) GMA-500mA | (4) MDL-V-3 |
- (2) Pr. 4121 Fuse clips
 (2) HHB Inline fuse holder
 (1) HTB-26I panel mount fuse holder
 (1) HTB-28M panel mount fuse holder
 (1) S-8202-2 Two-pole fuse block

Small Electronic Fuse Kit



Fuse Kit 140

Small dimension fuse kit with 140 fuses, fuse holders, fuse blocks and fuse clips to fit most electronic equipment.

Ratings:

Volts: — 125V/250V

Catalog Number: NO.140

Assortment Contents

- | | |
|--------------------------|----------------------------|
| (5) MDL- $\frac{1}{2}$ | (5) AGC-1- $\frac{1}{2}$ |
| (5) MDL-1 | (5) AGC-2 |
| (5) MDL-1- $\frac{1}{2}$ | (5) AGC-3 |
| (5) MDQ-2 | (5) MTH-4 |
| (5) MDQ-3 | (5) MTH-5 |
| (5) MDQ-4 | (5) MTH-6 |
| (5) MDQ-5 | (5) MTH-7 |
| (5) MDQ-6 | (5) MTH-8 |
| (5) MDA-8 | (5) ABC-10 |
| (5) MDA-10 | (5) ABC-15 |
| (5) MDA-15 | (5) ABC-20 |
| (5) MDA-20 | (5) ABC-30 |
| (5) MDA-30 | (2) Pr. #4121 Fuse clips |
| (5) AGC- $\frac{1}{4}$ | (2) HHB Inline fuse holder |
| (5) AGC- $\frac{1}{2}$ | (1) FP-A3 Fuse puller |
| (5) AGC-1 | |

Electrical and Electronic Fuse Kit



5 x 20mm Fuse Kit 220

A complete assortment of 125V and 250V 5 x 20mm fuses for the repair of both electrical and electronic devices.

Ratings:

Volts: — 125V/250V

Catalog Number: NO.220

Assortment Contents

- | | | |
|---------------|---------------|---------------|
| (5) GMA-250mA | (5) GDA-6.3 | (5) GMD-200mA |
| (5) GMA-500mA | (5) GDB-630mA | (5) GMD-500mA |
| (5) GMA-1 | (5) GDB-2 | (5) GMD-1 |
| (5) GMA-1.5 | (5) GDB-3.15 | (5) GMD-1.6 |
| (5) GMA-2 | (5) GDB-4 | (5) GMD-2 |
| (5) GMA-2.5 | (5) GMC-500mA | (5) GMD-3 |
| (5) GMA-3 | (5) GMC-750mA | (5) GDC-250mA |
| (5) GMA-4 | (5) GMC-1 | (5) GDC-500mA |
| (5) GMA-5 | (5) GMC-2 | (5) GDC-1 |
| (5) GMA-10 | (5) GMC-2.5 | (5) GDC-1.6 |
| (5) GDA-630mA | (5) GMC-3 | (5) GDC-2 |
| (5) GDA-1 | (5) GMC-3.15 | (5) GDC-3.15 |
| (5) GDA-2 | (5) GMC-4 | (5) GDC-4 |
| (5) GDA-3.15 | (5) GMC-5 | (5) GDC-5 |
| (5) GDA-5 | (5) GMC-6.3 | |
- (1) HTB-28M panel mount fuse holder
 (1) FP-A3 Fuse puller

Clip Clamps and Rail Adapters (DIN & American)

TRON™ Clip-Clamps

Specifications

Description: Clamps for ferrule and blade-type cartridge fuse clips. Provide tight contacts between fuse holder clips and fuse ferrules/blades.

Construction: Phenolic knob and plated-steel jaws.

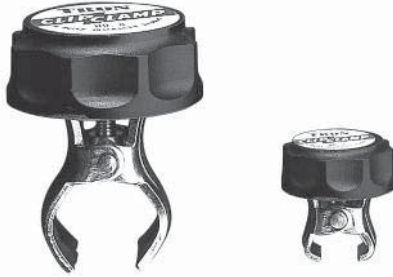

Catalog Numbers

Catalog Numbers	Clamp Size	
	Volts	Amps
NO.1	250	0-30
NO.2	250	35-60
NO.2	600	0-30
NO.4	600	35-60
NO.5	250/600	70-100
NO.6	250/600	110-200
NO.7	250/600	225-400
NO.8	250/600	450-600

Adapters for DIN and American Rails

Specifications

Description:

Bussmann DIN-Rail adapters permit secure, positive snap-on mounting of Bussmann 0-30A fuse blocks (one-, two-, or three-pole) onto various size rails to eliminate costly and time consuming drilling, tapping, and screw mounting. Adapters mechanically lock into mounting holes of fuse blocks in

seconds to become an integral part of the block.

One adapter is required for one- and two-pole Bussmann blocks. Two adapters are required for three-pole blocks.

With the exception of the 32mm DIN-Rail, all blocks with adapters can be removed from a rail simply by pulling up its release tab.

Use of rail end-stops on both sides of adapters is recommended.

Construction: Molded from “Lexan™ 241” for high strength and flexibility.

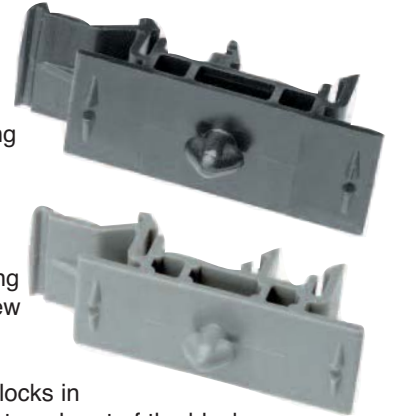

Catalog Numbers (For 0-30A Fuse Blocks)

Catalog Numbers	Fuse Block Class	Rail Type	Size	Adapter Color
DRA-1	CC	DIN	15mm (Sym.)	Black
	G		32mm (Asym.)	
	*H (250V)		35mm (Sym.)	
DRA-2	*R (250)	American	1/8" (Sym.)	Gray
	M Type		(also 35mm DIN)	

Package Quantities: standard—10; bulk—100 (Cat. No. BK/DRA-1 or BK/DRA-2.)

*Mounting on 15mm rails is not recommended.

NOTE—Newer Bussmann fuse blocks have elongated block-to-adapter mounting holes (old style fuse blocks will not accept the rail adapters).

Spare Fuse Holders, Pullers, Testers and Cabinets

Spare Fuse Holders



Specifications

Description: Spare fuse holders durably constructed using black thermoplastic with common mounting using #6 screws or bolts on 5-inch centers. Dovetailed interlocking between fuse holders simplifies installation and reduces needed hardware. Common footprint allows for any combination of fuse holders to be mounted together. Built-in retaining clips secure fuses.

Flammability Rating: UL 94V0.

Catalog Numbers

Catalog Numbers	Capacity	For Use With:
TPSFH-CW	4-position	TPC and/or TPW fuses
TPSFH-M	4-position	TPM fuses
TPSFH-LC	1-position	TPL-C series fuses
TPSFH-LB	1-position	TPL-B series fuses
TPSFH-N60	1-position	TPN (35-60A) fuses
TPSFH-N30	4-position	TPN (1-30A) fuses
TPSFH-AS	6-position	TPA & TPS fuses
TPSFH-T	10-position	GMT fuses

5TPH



Specifications

Description: 5-position spare fuse holder for midsize and Class CC fuses (1 3/8" diameter) fuses. Constructed of thermoplastic with adhesive tape on back for easy mounting on cabinet doors.

Size: 2.98" W x 1.03" H x 0.63" D

Catalog Number: 5TPH

Data Sheet: 5014

Fuse Pullers



Specifications

Description: Fuse pullers in various sizes to safely and easily extract fuses from blocks and holders.

Catalog Numbers

Catalog Numbers	Application
FP-2	1/2" to 3/8" dia. fuses
FP-3	1" to 1 1/2" dia. fuses
FP-4	1 1/2" to 2 1/2" dia. fuses
FP-6	0-60A T-Tron fuses
FP-A3	Glass Tube & ATC fuses
CFP-30	CUBEFuse 1-30A
CFP-60	CUBEFuse 35-60A
CFP-100	CUBEFuse 70-100A

Fuse pullers are only to be used when the associated circuit has been de-energized.

FT-2 Fuse Tester



Specifications

Description: Fuse tester for automotive, glass tube and ferrule fuses up to 1 1/8" length. Probe slides to appropriate fuse length. Batteries are included and replaceable.

WARNING: DO NOT test electrical fuses in the fuse panel.

Catalog Number: FT-2

Replacement Battery:
Rayovac 364

SFC Spare Fuse Cabinet



Specifications

Description: Spare fuse cabinet with five cubic feet of storage space. Constructed of heavy gauge steel with durable baked ASA 61 grey enamel finish. Cabinet door is equipped with locking handle for security. Mounting holes are 16 inches on center with key slots.

Size: 24" W x 30" H x 12" D

Material: 0.062 sheet steel

Catalog Numbers:

SFC-FUSE-CAB

SFC-SHELF*

*Extra shelf for fuse cabinet.

Data Sheet: 1119

FT-3 Fuse Tester



Specifications

Description: Fuse tester for automotive, glass tube and ferrule fuses up to 1 1/8" length. Probe slides to appropriate fuse length. Batteries are included and replaceable.

WARNING: DO NOT test electrical fuses in the fuse panel.

Catalog Number: FT-3

Fuse Reducers and Dummy "Neutrals"

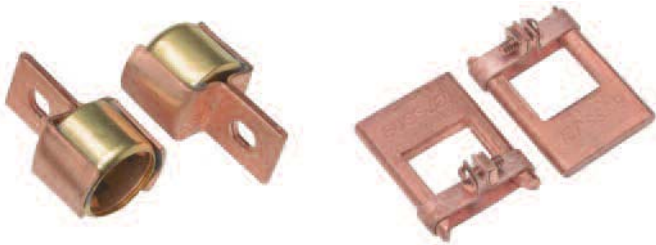

Fuse Reducers for Class J Fuses: LPJ, DFJ, JKS

Catalog Numbers

Catalog Numbers (Pair) Reducer No.	Fuse Amp Size Range	Equipment/Fuseblock Amp Size
J-63	1-30	60
J-13	1-30	100
J-16	35-60	100
J-26	35-60	200†
J-21	70-100	200†
J-41	70-100	400†
J-42	110-200	400†
J-62	110-200	600†
J-64	225-400	600†

†Not for Bolt-on Applications.

Fuse Reducers for Class R Fuses: FRN-R, LPN-RK, FRS-R, LPS-RK KTN-R, KTS-R

UL Listed File E12853

Catalog Numbers

Catalog Numbers (Pairs) Voltages		Fuse Amp Size Range	Equipment/Fuseblock Amp Size
250V	600V		
NO.263-R	NO.663-R	1-30	60
NO.213-R	NO.216-R	1-30	100
NO.216-R	NO.616-R	35-60	100
NO.226-R	NO.626-R	35-60	200
NO.2621-R	NO.2621-R	70-100	200
NO.2641-R	NO.2641-R	70-100	400
NO.242-R	NO.642-R	110-200	400
NO.2661-R	NO.2661-R	70-100	600
NO.2662-R	NO.2662-R	110-200	600
NO.2664-R**	NO.2664-R**	225-400	600

**Single reducer only (pair not required).

Fuse Reducers for Class H & K Fuses: NON, REN, NOS, RES

UL Listed File E12853

Catalog Numbers

Catalog Numbers. (Pairs)		Fuse Amp Size Range	Equipment/ Fuseblock Amp Size
250V Reducer	600V Reducer		
NO.263	NO.663	1-30	60
NO.213	NO.216	1-30	100
NO.216	NO.616	35-60	100
NO.226	NO.626	35-60	200
NO.2621	NO.2621	70-100	200
NO.2641	NO.2641	70-100	400
NO.2642	NO.2642	110-200	400
No. 2661	No. 2661	70-100	600

Data Sheet: 1118



Dummy Fuse "Neutrals" (These are not fuses)

Catalog Numbers

Catalog Numbers	Fuse Equivalent		
	Voltage	Dimension	Fuse Amp Size Range
NNB	—	1 ³ / ₁₆ " x 1 ¹ / ₂ "	—
NNB-R	—	Class CC	—
NNC	—	1/4" x 1/4"	—
NTN-R-30	250	R/H	1-30
NTN-R-60	250	R/H	35-60
NTN-R-100	250	R/H	70-100
NTN-R-200	250	R/H	110-200
NTN-R-400	250	R/H	225-400
NTS-R-30	600	R/H	1-30
NTS-R-60	600	R/H	35-60
NTS-R-100	600	R/H	70-100
NTS-R-200	600	R/H	110-200
NTS-R-400	600	R/H	225-400
NTS-R-600	600	R/H	450-600

Compact modular fuse holders

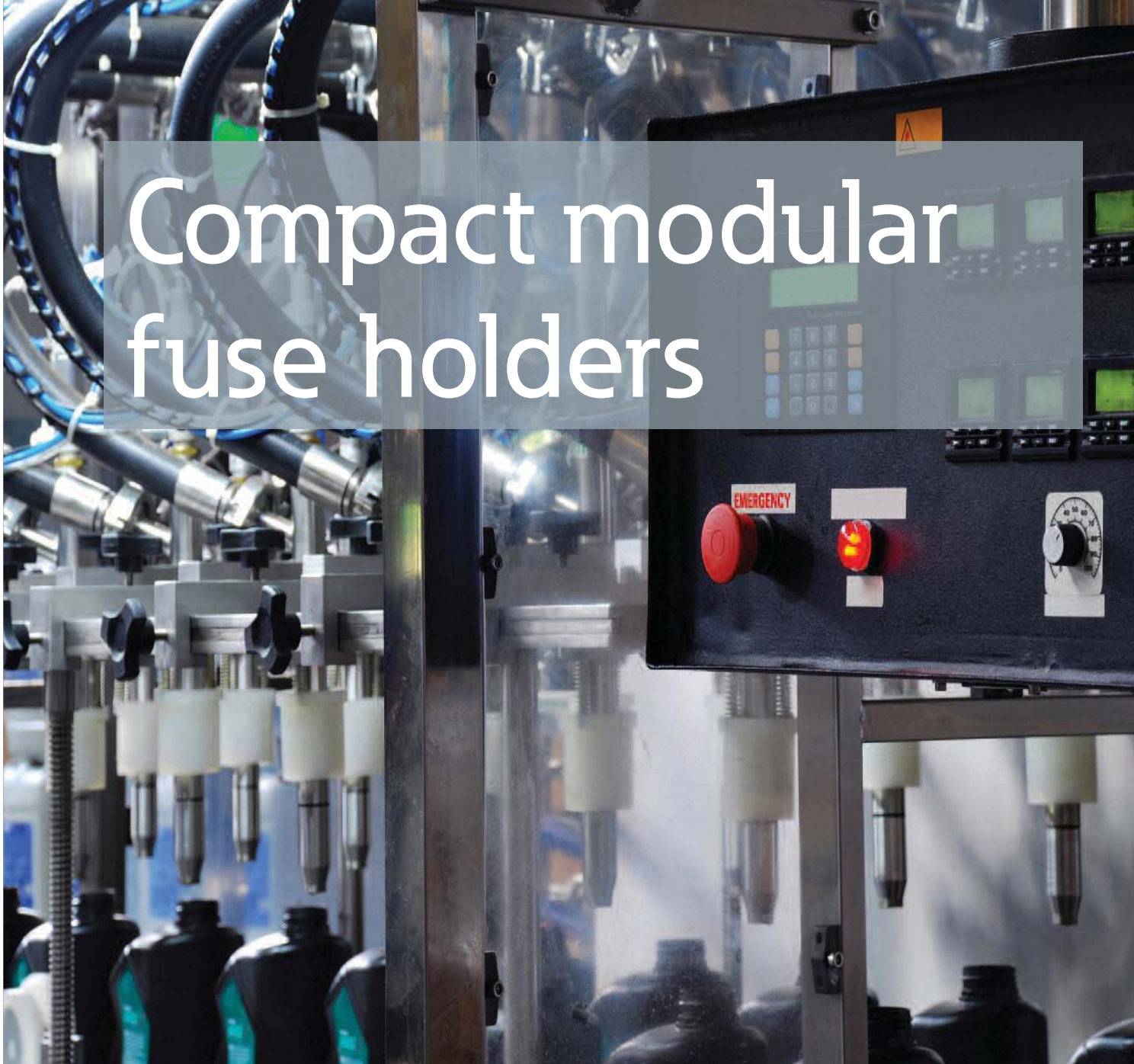

Finger-safe DIN-Rail mount fuse holders protect your electrical system & simplify installation

Bussmann
by **EAT•N**

Bussmann Services & Application Guide

Downtime Reduction, Workplace Safety & Code Compliance

Services to Increase Your Productivity Through Protection

Section Contents

Bussmann Services

Testing 514

Custom Products 515

Application Guide

Fuse technology 516-522

Motor circuit branch circuit protection 523

Glossary 524-526

Out-of-stock substitution/upgrades 526

Industrial & commercial fuse applications 527

Catalog number index 528-???

Sales support ???



RED indicates NEW information

Testing



Performance and Compliance Certification for Components and Assemblies

The Bussmann Paul P. Gubany Center for High Power Technology at Bussmann is the electrical industry's most comprehensive facility for testing and certifying electrical components and assemblies.

OEM customers make the Gubany Center their first choice in testing equipment such as:

- Drives, both AC and DC
- Circuit breakers
- Motor control centers
- Soft starters
- Fuses
- Power distribution panels
- Surge suppressors
- Cables

Wide Range of Capability

Built to exceed the short circuit capacity of today's high power electrical distribution systems, the Gubany Center performs:

- Ultra-high power testing from 200kA to 300kA at 600Vac, three-phase
- Medium power testing from 5kA to 200kA at 600Vac, single- and three-phase; to 100kA at 1450Vac single-phase; to 100kA at 1000Vdc
- Low power testing up to 5kA at 600Vac, single-phase.

Our technicians conduct tests to many global agency standards including:

- ANCE
- ANSI
- CE
- CSA
- ETL
- IEC, and
- Underwriters Laboratories



To Order:

To find out more contact your local Bussmann representative, or visit us online at www.cooperbussmann.com/services.

Testing Catalog Numbers		
Description		Catalog Number
High Power Testing	Hourly Rate	CBSV-ES-TEHP
Medium Power Testing	Hourly Rate	CBSV-ES-TEMP
Low Power Testing	Hourly Rate	CBSV-ES-TELP

Custom Products

Creating the Right Answers to Unique or Demanding Needs

When you wish to gain a competitive edge or improve your product's performance, have Bussmann provide a custom product that can:

- Improve functionality and utility
- Fit unique design needs
- Reduce labor and component costs

Our Expertise Is Your Advantage

For almost 100 years, Bussmann has designed and manufactured products that improve electrical safety and performance. Whether it's modifying an existing product or creating a new one, our experience effectively brings together the skills to design, prototype, test, manufacture and secure agency approvals to deliver a single component, sub-assembly or finished product.

Bussmann can design and manufacture products that integrate:

- Fuses - with the right size and performance characteristics
- Fuse holders and blocks - with the requisite terminations, mounting options and safety features
- Wire connection products - that make wiring simpler, safer and faster
- Molded products - that give the unique shape your product needs
- Power distribution products - that meet prevailing agency and Code requirements

In-House Testing

All electrical performance testing of your custom products can be performed at the Bussmann Paul P. Gubany Center for High Power Technology, an ASTA and CSA accredited, and an ANCE Designated facility.

We're able to conduct electrical performance testing that replicates any power system to be encountered in any country, covering:

- Up to 300kA and 600Vac
- Up to 100kA and 1000Vdc

And our technicians conduct tests to many global agency standards including:

- ANCE
- ANSI
- CE
- CSA
- ETL
- IEC, and
- Underwriters Laboratories

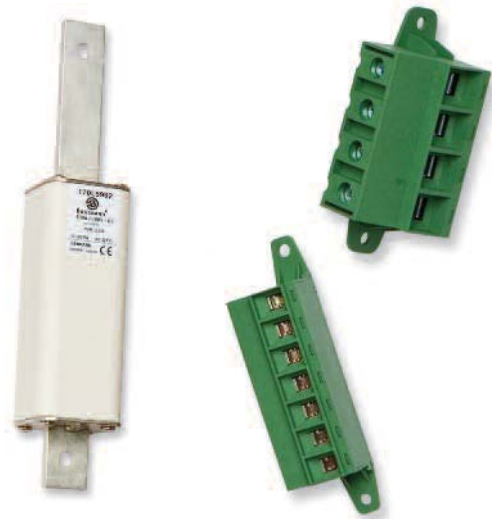

To Find Out More:

If you need a custom solution to a product problem, submit a Request for Quotation to your local authorized Bussmann distributor or sales representative.

Fuse Technology

Circuit Protection

The following is a basic introduction to overcurrent protection and fuse technology. In depth information on the selection and application of overcurrent protective devices is available in the Bussmann publication “Selecting Protective Devices” (SPD). This publication is available free of charge as a PDF download at www.cooperbussmann.com/spd.

Electrical distribution systems are often quite complicated. They cannot be absolutely fail-safe. Circuits are subject to destructive overcurrents. Harsh environments, general deterioration, accidental damage, damage from natural causes, excessive expansion, and/or overloading of the electrical distribution system are factors which contribute to the occurrence of such overcurrents. Reliable protective devices prevent or minimize costly damage to transformers, conductors, motors, and the other many components and loads that make up the complete distribution system. Reliable circuit protection is essential to avoid the severe monetary losses which can result from power blackouts and prolonged downtime of facilities. It is the need for reliable protection, safety, and freedom from fire hazards that has made the fuse a widely used protective device.

Overcurrents

An overcurrent is either an overload current or a short-circuit current. The overload current is an excessive current relative to normal operating current, but one which is confined to the normal conductive paths provided by the conductors and other components and loads of the distribution system. As the name implies, a short-circuit current is one which flows outside the normal conducting paths.

Overloads

Overloads are most often between one and six times the normal current level. Usually, they are caused by harmless temporary surge currents that occur when motors are started-up or transformers are energized. Such overload currents, or transients, are normal occurrences. Since they are of brief duration, any temperature rise is trivial and has no harmful effect on the circuit components. (It is important that protective devices do not react to them.)

Continuous overloads can result from defective motors (such as worn motor bearings), overloaded equipment, or too many loads on one circuit. Such sustained overloads are destructive and must be cut off by protective devices before they damage the distribution system or system loads. However, since they are of relatively low magnitude compared to short-circuit currents, removal of the overload current within minutes will generally prevent equipment damage. A sustained overload current results in overheating of conductors and other components and will cause deterioration of insulation, which may eventually result in severe damage and short-circuits if not interrupted.

Short-Circuits

Whereas overload currents occur at rather modest levels, the short-circuit or fault current can be many hundred times larger than the normal operating current. A high level fault may be

50,000A (or larger). If not cut off within a matter of a few thousandths of a second, damage and destruction can become rampant—there can be severe insulation damage, melting of conductors, vaporization of metal, ionization of gases, arcing, and fires. Simultaneously, high level short-circuit currents can develop huge magnetic-field stresses. The magnetic forces between bus bars and other conductors can be many hundreds of pounds per linear foot; even heavy bracing may not be adequate to keep them from being warped or distorted beyond repair.

Fuses

The fuse is a reliable overcurrent protective device. A “fusible” link or links encapsulated in a tube and connected to contact terminals comprise the fundamental elements of the basic fuse. Electrical resistance of the link is so low that it simply acts as a conductor. However, when destructive currents occur, the link very quickly melts and opens the circuit to protect conductors, and other circuit components and loads. Fuse characteristics are stable. Fuses do not require periodic maintenance or testing. Fuses have three unique performance characteristics:

1. *Modern fuses have an extremely “high interrupting rating”—can withstand very high fault currents without rupturing.*
2. *Properly applied, fuses prevent “blackouts.” Only the fuse nearest a fault opens without upstream fuses (feeders or mains) being affected—fuses thus provide “selective coordination.” (These terms are precisely defined in subsequent pages.)*
3. *Fuses provide optimum component protection by keeping fault currents to a low value...They are said to be “current limiting.”*

Voltage Rating

The voltage rating of a fuse must be at least equal to or greater than the circuit voltage. It can be higher but never lower. For instance, a 600V fuse can be used in a 208V circuit.

The voltage rating of a fuse is a function of its capability to open a circuit under an overcurrent condition. Specifically, the voltage rating determines the ability of the fuse to suppress the internal arcing that occurs after a fuse link melts and an arc is produced. If a fuse is used with a voltage rating lower than the circuit voltage, arc suppression will be impaired and, under some fault current conditions, the fuse may not clear the overcurrent safely. Special consideration is necessary for semiconductor fuse and medium voltage fuse applications, where a fuse of a certain voltage rating is used on a lower voltage circuit.

Amp Rating

Every fuse has a specific amp rating. In selecting the amp rating of a fuse, consideration must be given to the type of load and code requirements. The amp rating of a fuse normally should not exceed the current carrying capacity of the circuit. For instance, a continuous load current of 16 amperes typically requires a conductor rated to carry 20A and a 20A fuse is the largest that should be used. However, there are some specific circumstances in which the amp rating is permitted to be greater than the current carrying capacity of the circuit.

Fuse Technology

A typical example is the motor circuit; dual-element fuses generally are permitted to be sized up to 175% and non-time-delay fuses up to 300% of the motor full-load amps. As a rule, the amp rating of a fuse and switch combination should be selected at 125% of the continuous load current (this usually corresponds to the circuit capacity, which is also selected at 125% of the load current). There are exceptions, such as when the fuse-switch combination is approved for continuous operation in an assembly at 100% of its rating.

Interrupting Rating

A protective device must be able to withstand the destructive energy of short-circuit currents. If a fault current exceeds the capability of the protective device, the device may actually rupture, causing additional damage. Thus, it is important when applying a fuse or circuit breaker to use one which can sustain the largest potential short-circuit currents. The rating which defines the capacity of a protective device to maintain its integrity when reacting to fault currents is termed its “interrupting rating”. The interrupting rating of most branch-circuit, molded case, circuit breakers typically used in residential service entrance panels is 10,000A. Larger, more expensive circuit breakers may have interrupting ratings of 14,000A or higher. In contrast, most modern, current-limiting fuses have an interrupting rating of 200,000 or 300,000A and are commonly used to protect the lower rated circuit breakers. The National Electrical Code, Section 110-9, and §OSHA 29 CFR 1910.303(b)(4) require equipment intended to break current at fault levels to have an interrupting rating sufficient for the current that must be interrupted.

Selective Coordination – Prevention of Blackouts

Coordination is isolation of an overloaded or faulted circuit by the opening of only the nearest upstream protective device for a specific overcurrent value. When only the nearest upstream protective device of an overloaded or faulted circuit opens and larger upstream fuses remain closed for the full range of overcurrents on a system, the protective devices are “selectively” coordinated (they discriminate). Selective coordination of protective devices prevents unnecessary system power outages or blackouts caused by overcurrent conditions.

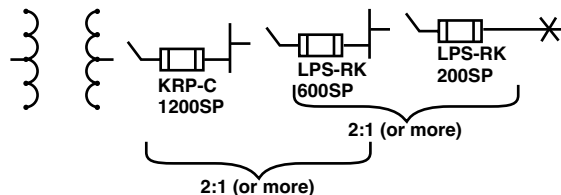

This diagram shows the minimum ratios of amp ratings of Low-Peak Yellow fuses that are required to provide “selective coordination” (discrimination) of upstream and downstream fuses.

It is a simple matter to selectively coordinate modern current-limiting fuses. By maintaining a minimum ratio of fuse-amp ratings between an upstream and downstream fuse, selective coordination is assured.

Current Limitation – Component Protection

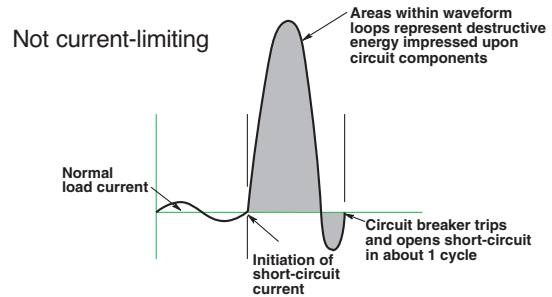

A non-current-limiting protective device, by permitting a short-circuit current to build up to its full value, can let an immense amount of destructive short-circuit heat energy through before opening the circuit.

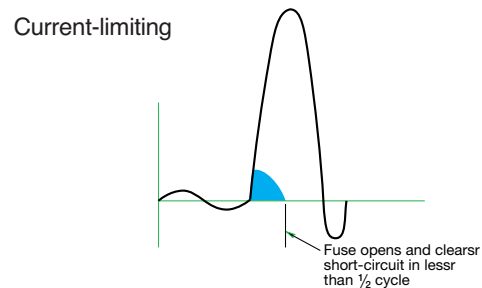

A current-limiting fuse has such a high speed of response that it cuts off a short-circuit long before it can build up to its full peak value, when the fault current is within the current-limiting range of a fuse.

If a protective device cuts off a short-circuit current in less than one-half cycle, before it reaches its total available (and highly destructive) value, the device is a “current-limiting” device. Most modern fuses are current-limiting. They restrict fault currents to such low values that a high degree of protection is given to circuit components against even very high short-circuit currents. They permit breakers with lower interrupting ratings to be used when series rated. They can reduce bracing of bus structures. They minimize the need of other components to have high short-circuit current “withstand” ratings. If not limited, short-circuit currents can reach levels of 30,000 or 40,000A or higher in the first half cycle (.008 seconds, 60Hz) after the start of a short-circuit. The heat that can be produced in circuit components by the immense energy of short-circuit currents can cause severe insulation damage or even explosion. At the same time, huge magnetic forces developed between conductors can crack insulators and distort and destroy bracing structures. Thus, it is important that a protective device limit fault currents before they reach their full potential level.

Fuse Technology

Operating Principles of Bussmann Fuses

The principles of operation of the modern, current-limiting fuses are covered in the following paragraphs.

Non-Time-Delay Fuses

The basic component of a fuse is the link. Depending upon the amp rating of the fuse, the single-element fuse may have one or more links. They are electrically connected to the end blades (or ferrules) (see Figure 1) and enclosed in a tube or cartridge surrounded by an arc quenching filler material. Bussmann Limitron™ and T-Tron™ fuses are both single-element fuses.

Under normal operation, when the fuse is operating at or near its amp rating, it simply functions as a conductor. However, as illustrated in Figure 2, if an overload current occurs and persists for more than a short interval of time, the temperature of the link eventually reaches a level which causes a restricted segment of the link to melt. As a result, a gap is formed and an electric arc established. However, as the arc causes the link metal to burn back, the gap becomes progressively larger. Electrical resistance of the arc quickly reaches such a high level that the arc cannot be sustained and is extinguished. The fuse will have then completely cut off all current flow in the circuit. Suppression or quenching of the arc is accelerated by the filler material. (See Figure 3.)

Single-element fuses of present day design have a very high speed of response to overcurrents. They provide excellent short-circuit component protection. However, temporary, harmless overloads or surge currents may cause nuisance openings unless these fuses are oversized. They are best used, therefore, in circuits not subject to heavy transient surge currents and the temporary over-load of circuits with inductive loads such as motors, transformers, solenoids, etc. Because single-element, fast-acting fuses such as Limitron and T-Tron fuses have a high speed of response to short-circuit currents, they are particularly suited for the series rating protection of circuit breakers with low interrupting ratings.

Whereas an overload current normally falls between one and six times normal current, short-circuit currents are quite high. The fuse may be subjected to short-circuit currents of 30,000 or 40kA or higher. Response of current limiting fuses to such currents is extremely fast. The restricted sections of the fuse link will simultaneously melt (within a matter of two or three-thousandths of a second in the event of a high-level fault current).

The high total resistance of the multiple arcs, together with the quenching effects of the filler particles, results in rapid arc suppression and clearing of the circuit. (Refer to Figures 4 & 5) Short-circuit current is cut off in less than a half-cycle, long before the short-circuit current can reach its full value (fuse operating in its current limiting range).



Figure 1. Cutaway view of typical single-element fuse.



Figure 2. Under sustained overload, a section of the link melts and an arc is established.



Figure 3. The "open" single-element fuse after opening a circuit overload.



Figure 4. When subjected to a short-circuit current, several sections of the fuse link melt almost instantly.



Figure 5. The "open" single-element fuse after opening a short circuit.

Fuse Technology

Bussmann Dual-Element Fuses

There are many advantages to using these fuses. Unlike single-element fuses, the Bussmann dual-element, time-delay fuses can be sized closer to provide both high performance short-circuit protection and reliable overload protection in circuits subject to temporary overloads and surge currents. For ac motor loads, a single-element fuse may need to be sized at 300% of an a.c. motor current in order to hold the starting current. However, dual-element, time delay fuses can be sized much closer to motor loads. For instance, it is generally possible to size Fusetron Dual-Element Fuses, FRS-R and FRN-R and Low-Peak™ Dual-Element Fuses, LPS-RK_SP and LPN-RK_SP, at 125% and 130% of motor full load current, respectively. Generally, the Low-Peak Dual-Element Fuses, LPJ_SP, and CUBEFuse™, TCF, can be sized at 150 to 175% of motor full load amps. This closer fuse sizing may provide many advantages such as: (1) smaller fuse and block, holder or disconnect amp rating and physical size, (2) lower cost due to lower amp rated devices and possibly smaller required panel space, (3) better short-circuit protection – less short-circuit current let-through energy, and (4) potential reduction in the arc-flash hazard.

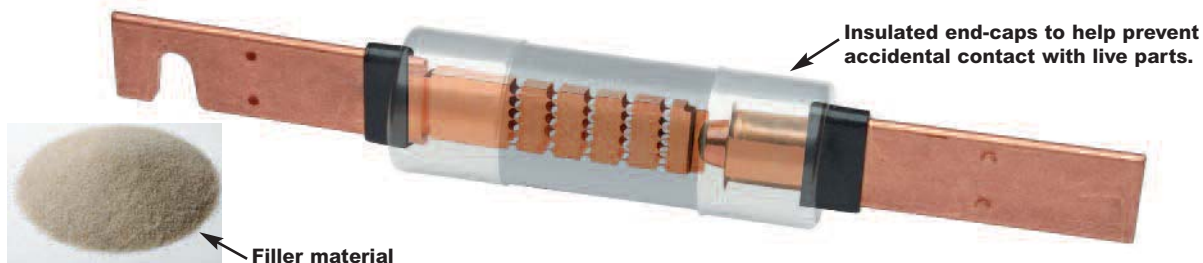

Figure 6. This is the LPS-RK100SP, a 100A, 600V Low-Peak, Class RK1, Dual-Element Fuse that has excellent time-delay, excellent current-limitation and a 300kA interrupting rating. Artistic liberty is taken to illustrate the internal portion of this fuse. The real fuse has a non-transparent tube and special small granular, arc-quenching material completely filling the internal space.

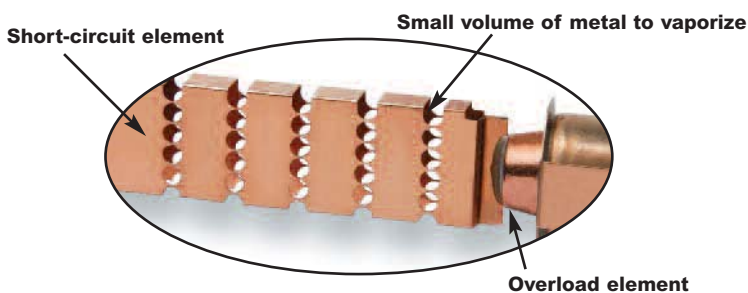

Figure 7. The true dual-element fuse has distinct and separate overload element and short-circuit element.

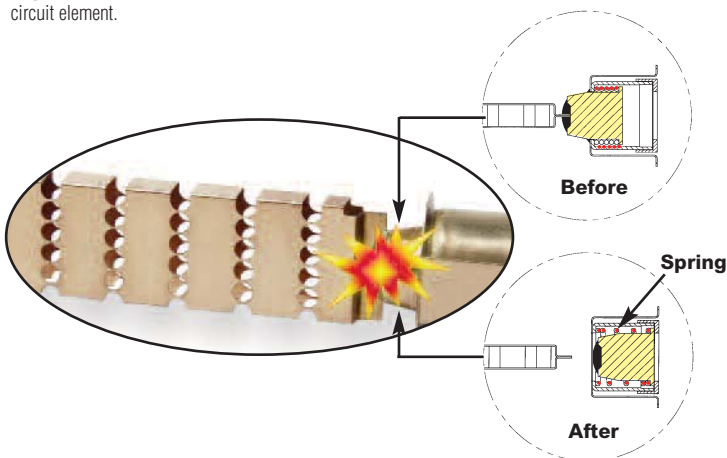

Figure 8. Overload operation: Under sustained overload conditions, the trigger spring fractures the calibrated fusing alloy and releases the “connector”. The insets represent a model of the overload element before and after. The calibrated fusing alloy connecting the short-circuit element to the overload element fractures at a specific temperature due to a persistent overload current. The coiled spring pushes the connector from the short-circuit element and the circuit is interrupted.

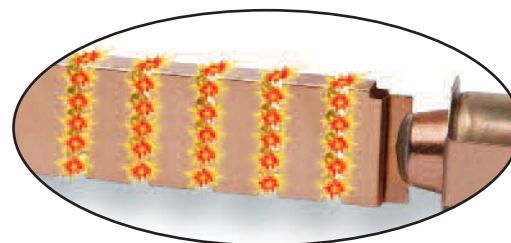

Figure 9. Short-circuit operation: Modern fuses are designed with minimum metal in the restricted portions which greatly enhance their ability to have excellent current-limiting characteristics – minimizing the short circuit let-through current. A short-circuit current causes the restricted portions of the short-circuit element to vaporize and arcing commences. The arcs burn back the element at the points of the arcing. Longer arcs result, which assist in reducing the current. Also, the special arc quenching filler material contributes to extinguishing the arcing current. Modern fuses have many restricted portions, which results in many small arlets – all working together to force the current to zero.

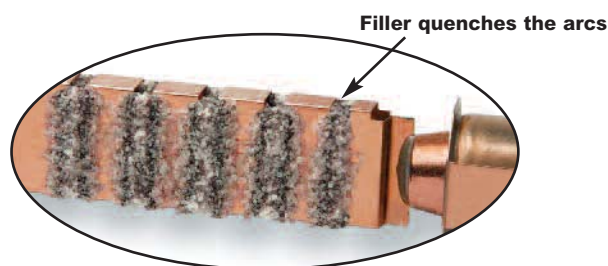

Figure 10. Short-circuit operation: The special small granular, arc-quenching material plays an important part in the interruption process. The filler assists in quenching the arcs; the filler material absorbs the thermal energy of the arcs, fuses together and creates an insulating barrier. This process helps in forcing the current to zero. Modern current-limiting fuses, under short-circuit conditions, can force the current to zero and complete the interruption within a few thousandths of a second.

When the short-circuit current is in the current-limiting range of a fuse, it is not possible for the full available short-circuit current to flow through the fuse – it’s a matter of physics. The small restricted portions of the short-circuit element quickly vaporize and the filler material assists in forcing the current to zero. The fuse is able to “limit” the short-circuit current.

Overcurrent protection must be reliable and sure. Whether it is the first day of the electrical system or thirty or more years later, it is important that overcurrent protective devices perform under overload or short-circuit conditions as intended. Modern current-limiting fuses operate by very simple, reliable principles.

Fuse Technology

Fuse Time-Current Curves

When a low level overcurrent occurs, a long interval of time will be required for a fuse to open (melt) and clear the fault. On the other hand, if the overcurrent is large, the fuse will open very quickly. The opening time is a function of the magnitude of the level of overcurrent. Overcurrent levels and the corresponding intervals of opening times are logarithmically plotted in graph form as shown to the right. Levels of overcurrent are scaled on the horizontal axis; time intervals on the vertical axis. The curve is thus called a “time-current” curve.

This particular plot reflects the characteristics of a 200A, 250V, Low-Peak™ dual-element fuse. Note that at the 1,000A overload level, the time interval which is required for the fuse to open is 10 seconds. Yet, at approximately the 2,200A overcurrent level, the opening (melt) time of a fuse is only 0.01 seconds. It is apparent that the time intervals become shorter as the overcurrent levels become larger. This relationship is termed an inverse time-to-current characteristic. Time-current curves are published or are available on most commonly used fuses showing “minimum melt,” “average melt” and/or “total clear” characteristics. Although upstream and downstream fuses are easily coordinated by adhering to simple amp ratios, these time-current curves permit close or critical analysis of coordination.

Better Motor Protection in Elevated Ambients

The derating of dual-element fuses based on increased ambient temperatures closely parallels the derating curve of motors in elevated ambient. This unique feature allows for optimum protection of motors, even in high temperatures.

Affect of ambient temperature on operating characteristics of Fusetron and Low-Peak dual-element fuses.

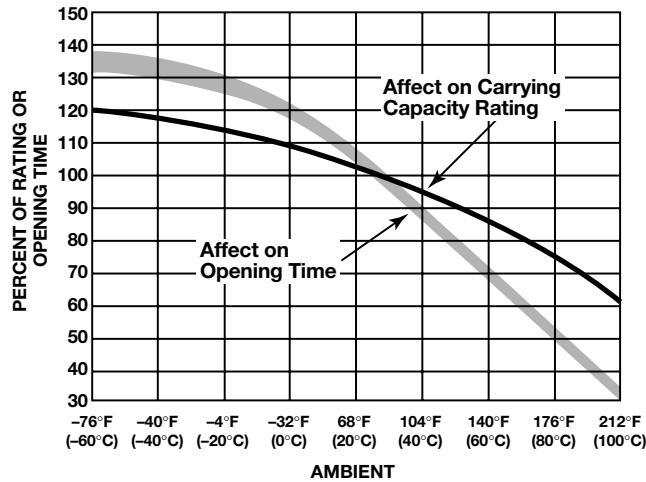

Below is a derating chart for single element fuses or non dual element fuses.

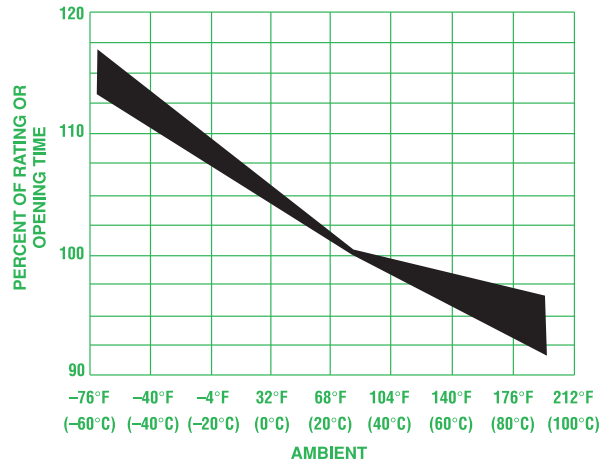

Ambient affect chart for non-dual-element fuses.

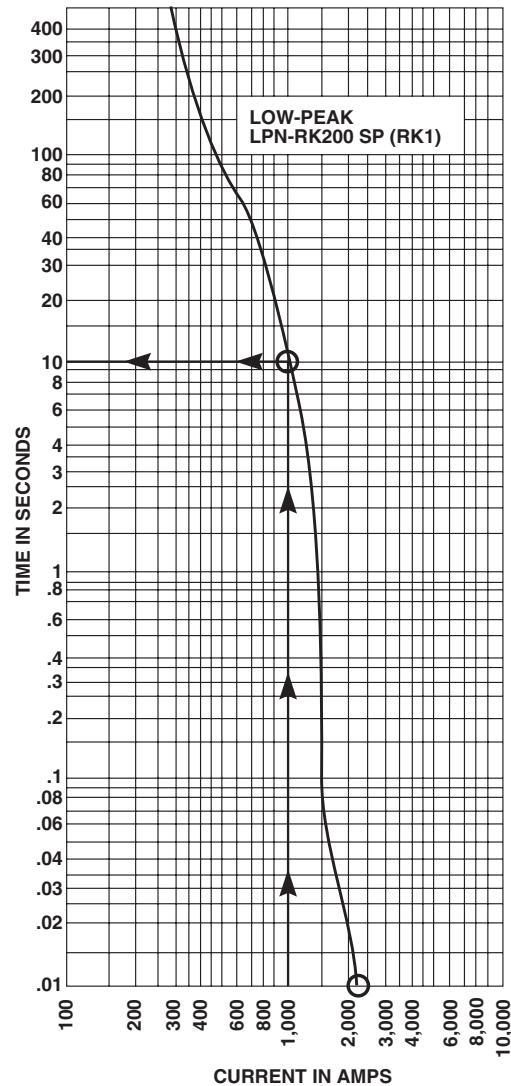

Fuse Technology

Better Protection Against Motor Single Phasing

When secondary single-phasing occurs, the current in the remaining phases increases to approximately 200% rated full load current. (Theoretically 173%, but change in efficiency and power factor make it about 200%.) When primary single-phasing occurs, unbalanced voltages occur on the motor circuit causing currents to rise to 115%, and 230% of normal running currents in delta-wye systems.

No overcurrent protective device sized only for motor branch circuit short-circuit, ground fault protection will provide single-phasing protection for 3-phase motors. Single-phasing causes are numerous including the utility system that supplies the service losing a phase. Single-phasing is not a serious concern for 3-phase motors when properly protected by three properly sized and calibrated overload protective devices. Many solid state motor controllers will sense and cause the motor controller to open for serious unbalanced voltage situations caused by single-phasing. FRN-R, FRS-R, LPN-R_SP and LPS-R_SP dual-element fuses sized for motor running overload protection will help to protect motors against the possible damages of single-phasing. In addition, additional unbalanced voltage protection can be incorporated into motor protection schemes, if desired. For more information refer to the Cooper Bussmann Selecting Protective Devices publication, section Voltage Unbalance & Single-Phasing.

Classes of Fuses

Safety is the industry mandate. However, proper selection, overall functional performance and reliability of a product are factors which are not within the basic scope of listing agency activities. In order to develop its safety test procedures, listing agencies develop basic performance and physical specifications or standards for a product. In the case of fuses, these standards have culminated in the establishment of distinct classes of low-voltage (600V or less) fuses; Classes RK1, RK5, G, L, T, J, H and CC being the more important.

The fact that a particular type of fuse has, for instance, a classification of RK1, does not signify that it has the identical function or performance characteristics as other RK1 fuses. In fact, the Limitron™ non-time-delay fuse and the Low-Peak dual-element, time-delay fuse are both classified as RK1. Substantial differences in these two RK1 fuses usually requires considerable difference in sizing. Dimensional specifications of each class of fuse does serve as a uniform standard.

Class R Fuses

Class R (“R” for rejection) fuses are high performance, 1/10 to 600A units, 250V and 600V, having a high degree of current limitation and a short-circuit interrupting rating of 200kA or 300kA (RMS Sym.). Bussmann Class R fuses include Class RK1 Low-Peak™ and Limitron™ fuses, and RK5 Fusetron fuses. They have replaced the K1 Low-Peak and Limitron fuses and K5 Fusetron fuses. These fuses are identical, with the exception of a modification in the mounting configuration called a “rejection feature.” This feature permits Class R fuses to be mounted in rejection type fuseclips. “R” type fuseclips prevent



older type Class H, ONE-TIME and RENEWABLE fuses from being installed. The use of Class R fuse holders is thus an important safeguard. The application of Class R fuses in such equipment as disconnect switches permits the equipment to have a high interrupting rating. NEC® 110-9 and §OSHA 29 CFR 1910.303(b)(4) require that protective devices have adequate capacity to interrupt short-circuit currents. Article 240-60(b) requires fuse holders for current-limiting fuses to reject non-current-limiting type fuses. In the above illustration, a grooved ring in one ferrule provides the rejection feature of the Class R fuse in contrast to the lower interrupting rating, non-rejection type.

Branch-Circuit Listed Fuses

Branch-circuit listed fuses are designed to prevent the installation of fuses that cannot provide a comparable level of protection to equipment.

The characteristics of Branch-circuit fuses are:

1. They must have a minimum interrupting rating of 10kA
2. They must have a minimum voltage rating of 125V.
3. They must be size rejecting such that a fuse of a lower voltage rating cannot be installed in the circuit.
4. They must be size rejecting such that a fuse with a current rating higher than the fuse holder rating cannot be installed.

Fuse Technology

Supplementary Overcurrent Protective Devices for use in Motor Control Circuits

Branch Circuit vs. Supplemental Overcurrent Protective Devices

Branch circuit overcurrent protective devices (OCPD) can be used everywhere OCPD are used, from protection of motors and motor circuits and group motor circuits, to protection of distribution and utilization equipment. Supplemental OCPD can only be used where proper protection is already being provided by a branch circuit device, by exception [i.e., 430.72(A)], or if protection is not required. Supplemental OCPD can often be used to protect motor control circuits but they cannot be used to protect motors or motor circuits. A very common misapplication is the use of a supplementary overcurrent protective device such as a UL 1077 mechanical overcurrent device for motor branch circuit short-circuit and ground fault protection. Supplemental OCPDs are incomplete in testing compared to devices that are evaluated for branch circuit protection. **THIS IS A SERIOUS MISAPPLICATION AND SAFETY CONCERN!!** Caution should be taken to assure that the proper overcurrent protective device is being used for the application at hand. Below is a description of popular supplementary overcurrent protective devices.

Most supplemental overcurrent protective devices have very low interrupting ratings. Just as any other overcurrent protective device, supplemental OCPDs must have an interrupting rating equal to or greater than the available short-circuit current.



Supplemental fuses as listed or recognized to the UL/CSA/ANCE Trinational 248-14 Standard

These are fuses that can have many voltages and interrupting ratings within the same case size. Examples of supplemental fuses are $1\frac{3}{32}$ " X $1\frac{1}{2}$ ", 5 x 20mm, and $\frac{1}{4}$ " x $1\frac{1}{4}$ " fuses. Interrupting ratings range from 35 to 100kA.

Reliability and Maintenance of Overcurrent Protective Devices

Whether the first day of the electrical system or years later, it is important that overcurrent protective devices perform under overload and fault conditions as intended.

Modern current-limiting fuses operate by very simple, reliable principles. Fuses do not have to be maintained. By their inherent design, fuses do not have elements or mechanisms to calibrate, adjust or lubricate. If and when fuses are called upon to open on an overcurrent, installing the same type and ampere rated fuses provides the circuit with new factory-calibrated protection. The original design integrity can be maintained throughout the life of the electrical system. One last point on fuse systems; the terminations, clips and disconnects should be maintained as necessary.

Motor Circuit Branch Circuit Protection

Motor Circuits – Choice of Overcurrent Protection

Motor circuits have unique characteristics and several functions, such as short-circuit protection, overload protection and automatic/ remote start/stop, that may be required. Sometimes the comment is made that users prefer circuit breakers because they can be reset. Let's examine the choice of either circuit breakers or current-limiting fuses for motor branch circuit protection.

In the case to be examined, fuses and circuit breakers (includes magnetic only circuit breakers which are called MCPs or motor circuit protectors) are sized with the intent to provide only short-circuit and ground fault protection for the motor branch circuit protection per 430.52. Other means, such as overload relays, provide the motor overload protection. Typical thermal magnetic circuit breakers can only be sized for motor branch circuit protection (typically 200% - 250% of motor current) because if they are sized closer, the motor starting current trips the circuit breaker's instantaneous mechanism. Magnetic only circuit breakers (MCPs) are intentionally not provided with overload capability; they only operate on short-circuit currents. There are some fuses such as the FRS-R and LPS-RK fuses that can be sized close enough for motor running overload protection or backup motor running protection. But for the discussion in this section, assume current-limiting fuses are sized only for motor short-circuit and ground fault protection.

It is important to note that in this protection level being discussed, a circuit breaker or fuses should only open if there is a fault on the motor circuit. A separate overload protective device, such as an overload relays, provides motor overload protection per 430.32. Here are some important considerations:

1. OSHA regulation 1910.334(b)(2) Use of Equipment states:

Reclosing circuits after protective device operation. After a circuit is deenergized by a circuit protective device, the circuit may not be manually reenergized until it has been determined that the equipment and circuit can be safely energized. The repetitive manual reclosing of circuit breakers or reenergizing circuits through replaced fuses is prohibited. NOTE: When it can be determined from the design of the circuit and the over-current devices involved that the automatic operation of a device was caused by an overload rather than a fault condition, no examination of the circuit or connected equipment is needed before the circuit is reenergized.

So the speed of reclosing a circuit breaker after a fault is not an advantage. The law requires that if the condition is a fault (that is the only reason the circuit breaker or fuses should open on a motor circuit), then the fault must be corrected prior to replacing fuses or resetting the circuit breaker.

2. The typical level of short-circuit protection for the motor starter provided by circuit breakers and MCPs is referred to as Type 1. This is because most circuit breakers are not current-limiting. So, for a loadside fault, the starter may sustain significant damage such as severe welding of contacts and rupturing of the heater elements. Or the heater/overload relay system may lose calibration. This is an acceptable level of performance per UL 508, which is the product standard for motor starters. Current-limiting fuses can be selected that can provide Type 2 "No Damage" short-circuit protection for motor starters.

Consequently, with circuit breaker protection, after a fault condition,

significant downtime and cost may be incurred in repairing or replacing the starter. With properly selected fuses for Type 2 protection, after the fault is repaired, only new fuses need to be inserted in the circuit; the starter does not have to be repaired or replaced.

3. *Circuit breakers must be periodically tested to verify they mechanical operate and electrically tested to verify they still are properly calibrated within specification. The circuit breaker manufacturers recommend this. Typically circuit breakers should be mechanically operated at least every year and electrically tested every 1 to 5 years, depending on the service conditions. Modern current-limiting fuses do not have to be maintained or electrically tested to verify they still will operate as intended. The terminations of both circuit breakers and fusible devices need to be periodically checked and maintained to prevent thermal damage. Plus fuse clips should be periodically inspected and if necessary maintained.*
4. *After a circuit breaker interrupts a fault, it may not be suitable for further service. UL 489, the product standard for molded case circuit breakers, only requires a circuit breaker to interrupt two short-circuit currents at its interrupting rating. Circuit breakers that are rated 100 amps or less do not have to operate after only one short-circuit operation under "bus bar" short-circuit conditions. If the fault current is high, circuit breaker manufacturers recommend that a circuit breaker should receive a thorough inspection with replacement, if necessary. How does one know a circuit breaker's service history or what level of fault current that a circuit breaker interrupts? With modern current-limiting fuses, if the fuse interrupts a fault, new factory calibrated fuses are installed in the circuit. The original level of superior short-circuit protection can be there for the life of the motor circuit.*
5. *After a fault, the electrician has to walk back to the storeroom to get new fuses; that is if spare fuses are not stored adjacent to the equipment. This does require some additional down time. However, if fuses opened under fault conditions, there is a fault condition that must be remedied. The electrician probably will be going back to the storeroom anyway for parts to repair the fault. If properly selected current-limiting fuses are used in the original circuit, the starter will not sustain any significant damage or loss of overload calibration.*

With circuit breaker protection on motor circuits, after a fault condition, it may be necessary to repair or replace the starter, so a trip to the storeroom may be necessary. And if the starter is not significantly damaged, it may still need to be tested to insure the let-through energy by the circuit breaker has not caused the loss of starter overload calibration. Also, the circuit breaker needs to be evaluated for suitability before placing it back into service. Who is qualified for that evaluation? How much time will that take?

In summary, resetability is not an important feature for motor branch circuit (short-circuit) protection and resetability of the branch circuit protective device is not a benefit for motor circuits. As a matter of fact, resetability of the motor branch circuit overcurrent protective device may encourage an unsafe practice. The function of motor branch circuit protection is fault protection: short-circuit and ground fault protection. Faults do not occur on a regular basis. But when a fault does occur, it is important to have the very best protection. The best motor branch circuit protection can be judged by (1) reliability - its ability to retain its calibration and speed of operation over its lifetime, (2) current-limiting protection - its ability to provide Type 2 "No Damage" protection to the motor starter, and (3) safety - its ability to meet a facility's safety needs. Modern current-limiting fuses are superior to circuit breakers for motor branch circuit protection.

Glossary

Ampere (Amp)

The measurement of intensity of rate of flow of electrons in an electric circuit. An ampere (amp) is the amount of current that will flow through a resistance of one ohm under a pressure of one volt. Ampere is often abbreviated as "A."

Amp Rating

The current-carrying capacity of a fuse. When a fuse is subjected to a current above its amp rating, it will open the circuit after a predetermined period of time.

Amp Squared Seconds, I²t

The measure of heat energy developed within a circuit during the fuse's clearing. It can be expressed as "melting I²t", "arcing I²t" or the sum of them as "Clearing I²t". "I" stands for effective let-through current (RMS), which is squared, and "t" stands for time of opening, in seconds.

Arcing I²t

Value of the I²t during the arcing time under specified conditions.

Arcing Time

The amount of time from the instant the fuse link has melted until the overcurrent is interrupted, or cleared.

Breaking Capacity

(See Interrupting Rating)

Cartridge Fuse

A fuse consisting of a current responsive element inside a fuse tube with terminals on both ends.

Class CC Fuses

600V, 200kA interrupting rating, branch circuit fuses with overall dimensions of $1\frac{3}{8}$ " x $1\frac{1}{2}$ ". Their design incorporates a rejection feature that allows them to be inserted into rejection fuse holders and fuse blocks that reject all lower voltage, lower interrupting rating $1\frac{3}{8}$ " x $1\frac{1}{2}$ " fuses. They are available from $\frac{1}{4}$ A through 30A.

Class G Fuses

480V, 100kA interrupting rating branch circuit fuses that are size rejecting to eliminate overfusing. The fuse diameter is $1\frac{3}{32}$ " while the length varies from $1\frac{1}{16}$ " to $2\frac{1}{4}$ ". These are available in ratings from 1A through 60A.

Class H Fuses

250V and 600V, 10kA interrupting rating branch circuit fuses that may be renewable or non-renewable. These are available in amp ratings of 1A through 600A.

Class J Fuses

These fuses are rated to interrupt a minimum of 200kA AC. They are labeled as "Current-Limiting," are rated for 600Vac, and are not interchangeable with other classes.

Class K Fuses

These are fuses listed as K-1, K-5, or K-9 fuses. Each subclass has designated I²t and I_p maximums. These are dimensionally the same as Class H fuses, and they can have interrupting ratings of 50kA, 100kA, or 200kA. These fuses are current-limiting. However, they are not marked "current-limiting" on their label since they do not have a rejection feature.

Class L Fuses

These fuses are rated for 601 through 6000A, and are rated to interrupt a minimum of 200kA AC. They are labeled "Current-Limiting" and are rated for 600Vac. They are intended to be bolted into their mountings and are not normally used in clips. Some Class L fuses have designed in time-delay features for all purpose use.

Class R Fuses

These are high performance fuses rated $\frac{1}{4}$ -600A in 250V and 600V ratings. All are marked "Current Limiting" on their label and all have a minimum of 200kA interrupting rating. They have identical outline dimensions with the Class H fuses but have a rejection feature which prevents the user from mounting a fuse of lesser capabilities (lower interrupting capacity) when used with special Class R Clips. Class R fuses will fit into either rejection or non-rejection clips.

Class T Fuses

An industry class of fuses in 300V and 600V ratings from 1A through 1200A. They are physically very small and can be applied where space is at a premium. They are fast-acting fuses with an interrupting rating of 200kA RMS.

Classes of Fuses

The industry has developed basic physical specifications and electrical performance requirements for fuses with voltage ratings of 600V or less. These are known as standards. If a type of fuse meets the requirements of a standard, it can fall into that class. Typical classes are K, RK1, RK5, G, L, H, T, CC, and J.

Clearing Time

The total time between the beginning of the overcurrent and the final opening of the circuit at rated voltage by an overcurrent protective device. Clearing time is the total of the melting time and the arcing time.

Current Limitation

A fuse operation relating to short circuits only. When a fuse operates in its current-limiting range, it will clear a short circuit in less than $\frac{1}{2}$ cycle. Also, it will limit the instantaneous peak let-through current to a value substantially less than that obtainable in the same circuit if that fuse were replaced with a solid conductor of equal impedance.

Glossary

Dual Element Fuse

Fuse with a special design that utilizes two individual elements in series inside the fuse tube. One element, the spring actuated trigger assembly, operates on overloads up to 5-6 times the fuse current rating. The other element, the short circuit section, operates on short circuits up to their interrupting rating.

Electrical Load

That part of the electrical system which actually uses the energy or does the work required.

Fast-Acting Fuse

A fuse which opens on overload and short circuits very quickly. This type of fuse is not designed to withstand temporary overload currents associated with some electrical loads.

Fuse

An overcurrent protective device with a fusible link that operates and opens the circuit on an overcurrent condition.

High Speed Fuses

Fuses with no intentional time-delay in the overload range and designed to open as quickly as possible in the short-circuit range. These fuses are often used to protect solid-state devices.

Inductive Load

An electrical load which pulls a large amount of current—an inrush current—when first energized. After a few cycles or seconds the current “settles down” to the full-load running current.

Interrupting Capacity

(See Interrupting Rating)

Interrupting Rating — IR (Breaking Capacity)

The rating which defines a fuse’s ability to *safely* interrupt and clear short circuits. This rating is much greater than the ampere rating of a fuse. The NEC® defines Interrupting Rating as “The highest current at rated voltage that an overcurrent protective device is intended to interrupt under standard test conditions.”

Melting I²t

Value of the I²t during the melting time of the fuse link under specified conditions.

Melting Time

The amount of time required to melt the fuse link during a specified overcurrent. (See Arcing Time and Clearing Time.)

“NEC®” Dimensions

These are dimensions once referenced in the National Electrical Code. They are common to Class H and K fuses and provide interchangeability between manufacturers for fuses and fusible equipment of given ampere and voltage ratings.

Ohm

The unit of measure for electric resistance. An ohm is the amount of resistance that will allow one ampere to flow under a pressure of one volt.

Ohm’s Law

The relationship between voltage, current, and resistance, expressed by the equation $E = IR$, where E is the voltage in volts, I is the current in amps, and R is the resistance in ohms.

One Time Fuses

Generic term used to describe a Class H non-renewable cartridge fuse, with a single element.

Overcurrent

A condition which exists on an electrical circuit when the normal load current is exceeded. Overcurrents take on two separate characteristics—overloads and short-circuits.

Overload

Can be classified as an overcurrent which exceeds the normal full load current of a circuit. Also characteristic of this type of overcurrent is that it does not leave the normal current carrying path of the circuit—that is, it flows from the source, through the conductors, through the load, back through the conductors, to the source again.

Peak Let-Through Current, I_p

The instantaneous value of peak current let-through by a current-limiting fuse, when it operates in its current-limiting range.

Renewable Fuse (600V & below)

A fuse in which the element, typically a zinc link, may be replaced after the fuse has opened, and then reused. Renewable fuses are made to Class H standards.

Resistive Load

An electrical load which is characteristic of not having any significant inrush current. When a resistive load is energized, the current rises instantly to its steady-state value, without first rising to a higher value.

RMS Current

The RMS (root-mean-square) value of any periodic current is equal to the value of the direct current which, flowing through a resistance, produces the same heating effect in the resistance as the periodic current does.

SCCR

See Short-Circuit Current Rating

Semiconductor Fuses

Fuses used to protect solid-state devices. See “High Speed Fuses.”

Short-Circuit

Can be classified as an overcurrent which exceeds the normal full load current of a circuit by a factor many times (tens, hundreds or thousands greater). Also characteristic of this type of overcurrent is that it leaves the normal current carrying path of the circuit—it takes a “short cut” around the load and back to the source.

Short-Circuit Current Rating (SCCR)

The maximum short-circuit current an electrical component can sustain without the occurrence of excessive damage when protected with an overcurrent protective device.

Short-Circuit Withstand Rating

Same definition as short-circuit current rating.

Glossary

Single-Phasing

That condition which occurs when one-phase of a three-phase system opens, either in a low voltage (secondary) or high voltage (primary) distribution system. Primary or secondary single-phasing can be caused by any number of events. This condition results in unbalanced currents in polyphase motors and unless protective measures are taken, causes overheating and failure.

Threshold Current

The symmetrical RMS available current at the threshold of the current-limiting range, where the fuse becomes current-limiting when tested to the industry standard. This value can be read off of a peak let-through chart where the fuse curve intersects the A-B line. A threshold ratio is the relationship of the threshold current to the fuse's continuous current rating.

Time-Delay Fuse

A fuse with a built-in delay that allows temporary and harmless inrush currents to pass without opening, but is so designed to open on sustained overloads and short circuits.

Total Clearing I²t

Total measure of heat energy developed within a circuit during the fuse's clearing of a fault current. Total Clearing I²t is the sum of the melting I²t and arcing I²t.

Voltage Rating

The maximum open circuit voltage in which a fuse can be used, yet safely interrupt an overcurrent. Exceeding the voltage rating of a fuse impairs its ability to clear an overload or short-circuit safely.

Withstand Rating

The maximum current that an unprotected electrical component can sustain for a specified period of time without the occurrence of extensive damage.

Out-of-Stock Substitution/Upgrades

Bussmann #	Upgrade #	Description	Data Sheet #
AGC-(AMP)	ABC-(AMP)	FAST-ACTING, ¼" X 1¼" FUSE	2001
AGC-V-(AMP)	ABC-V-(AMP)	FAST-ACTING, ¼" X 1¼" FUSE WITH LEADS	2001
AGU-(AMP)	LP-CC-(AMP)	FAST-ACTING, ½" X 1½" FUSE	2008
BAF-(AMP)	LP-CC-(AMP)	FAST-ACTING, ½" X 1½" FUSE	2011
BAN-(AMP)	LP-CC-(AMP)	FAST-ACTING, ½" X 1½" FUSE	2046
DCM-(AMP)	PVM-(AMP)	SOLAR USE - FAST-ACTING, ½" X 1½" FUSE	2153
DCM-(AMP)	KLM-(AMP)	INDUSTRIAL - FAST-ACTING, ½" X 1½" FUSE	2020
DLS-(AMP)	ECNR-(AMP)	TIME-DELAY, 250Vac, CLASS RK5	1315
DLS-(AMP)	ECSR-(AMP)	TIME-DELAY, 600Vac, CLASS RK5	1318
FNM-(AMP)	LP-CC-(AMP)	TIME-DELAY, ½" X 1½" FUSE	2028
FNQ-R-(AMP)	LP-CC-(AMP)*	TIME-DELAY, 500V, ½" X 1½" FUSE	1012
FNR-R-(AMP)	LPN-RK-(AMP)SP	TIME-DELAY, 250V, CLASS RK5 FUSES	1019/1020
FRS-R-(AMP)	LPS-RK-(AMP)SP	TIME-DELAY, 600V, CLASS RK5 FUSES	1017/1018
JKS-(AMP)	LPJ-(AMP)SP	FAST-ACTING, 600V, CLASS J FUSE	1026/1027
KLU-(AMP)	KRP-C-(AMP)SP	TIME-DELAY, CLASS L FUSE	1013
KTK-(AMP)	KTK-R-(AMP)	FAST-ACTING, 600V, ½" X 1½" FUSE	1011
KTK-R-(AMP)	LP-CC-(AMP)	FAST-ACTING, 600V, CLASS CC FUSE	1015
KTN-R-(AMP)	LPN-RK-(AMP)SP	FAST-ACTING, 250V, CLASS RK1 FUSE	1043
KTS-R-(AMP)	LPS-RK-(AMP)SP	FAST-ACTING, 600V, CLASS RK1 FUSE	1044
KTU-(AMP)	KPR-C-(AMP)SP	FAST-ACTING, 600V, CLASS L FUSE	1010
KWS-R-(AMP)	LPS-RK-(AMP)SP	FAST-ACTING, 600V, CLASS RK1 FUSE	1044
MDL-(AMP)	MDA-(AMP)	TIME-DELAY, ¼" X 1¼" FUSE	2004
MDL-V-(AMP)	MDA-V-(AMP)	TIME-DELAY, ¼" X 1¼" FUSE WITH LEADS	2004
MTH-(AMP)	ABC-(AMP)	FAST-ACTING, ¼" X 1¼" FUSE	
NON-(AMP)	LPN-RK-(AMP)SP	GENERAL PURPOSE, 250V, CLASS H FUSES	1030
NOS-(AMP)	LPS-RK-(AMP)SP	GENERAL PURPOSE, 600V, CLASS H FUSES	1030
REN-(AMP)	LPN-RK-(AMP)SP	250V RENEWABLE FUSELINK	1028
RES-(AMP)	LPS-RK-(AMP)SP	600V RENEWABLE FUSELINK	1028
SL-(AMP)	S-(AMP)	TIME-DELAY, 125V, PLUG FUSE	1033
TL-(AMP)	T-(AMP)	TIME-DELAY, 125V, PLUG FUSE	1035
W-(AMP)	TL-(AMP)	TIME-DELAY, 125V, PLUG FUSE	1035

*Not recommended for control transformer circuits.

Industrial Fuse Applications

Industrial Applications

1. Interior Lighting
2. Computer Power
3. Switchboards
4. Motor Control Center
5. Emergency Lighting
6. UPS Backup Power Supplies
7. Transformer/Emergency Generator
8. Forklift Battery Charging Station
9. HVAC Chillers/Blowers
10. Welding Circuits
11. Plant Lighting
12. Distribution Panels
13. Disconnect Switches
14. Programmable Logic Circuits
15. Conveyor System

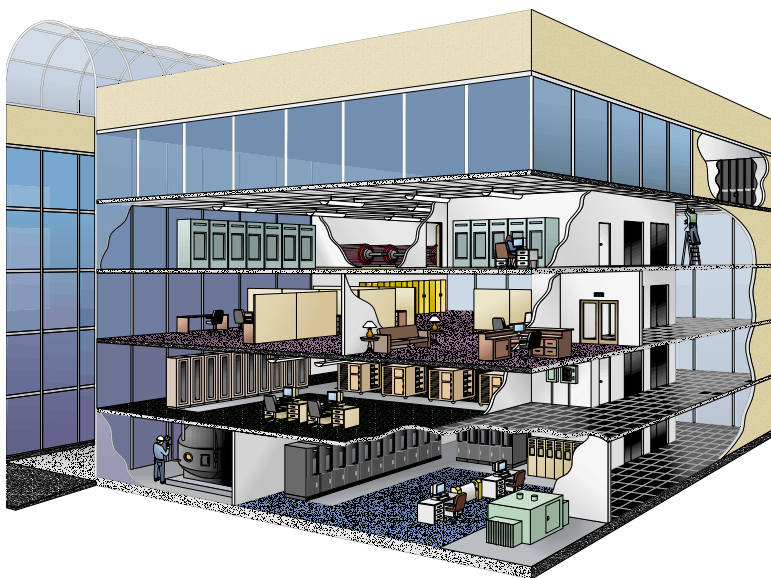
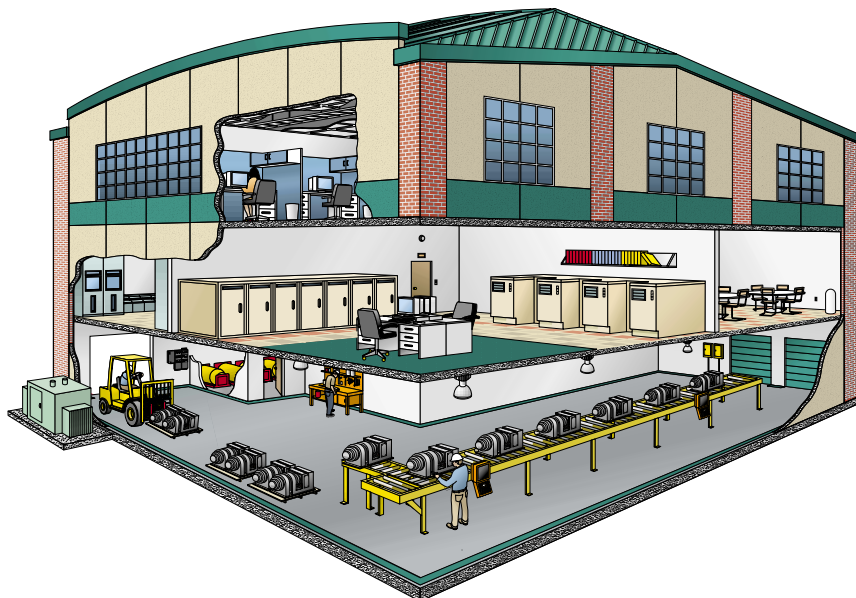

Commercial Applications

1. Interior Lighting
2. HVAC Blowers
3. Computer Power
4. Branch Circuits
5. Emergency Lighting
6. Load Centers
7. Disconnect/Distribution Panels
8. HVAC/Chillers
9. Switchboards/Motor Control Centers
10. UPS Backup Power Supplies
11. Elevator Control Centers
12. Transformer/Emergency Generator

Bussmann, the industry leader in critical circuit protection, power management and electrical safety offers an extensive selection of fuses and fuse blocks to meet precise overcurrent protection needs.

Whether it's glass tube, low voltage or high speed fuse ... or fuse blocks needed for an application, you can use this FuseFinder Quick Cross Reference Guide to find the Bussmann replacement. If you cannot find a cross, more extensive listings are available online at www.cooperbussmann.com/FuseFinder. Or contact our Application Engineers at FuseTech@cooperindustries.com.

Competitor Fuse Family	Bussmann	Competitor Fuse Family	Bussmann	Competitor Fuse Family	Bussmann
0481(AMP)	GMT-(AMP)A	413(AMP)	MDM-(AMP)	BDL(AMP)	MDL-(AMP)
211(AMP)	GDC-(AMP)	414(AMP)	ABS-(AMP)	BGC(AMP)	AGC-(AMP)
212(AMP)	GDB-(AMP)	417(AMP)	ABS-(AMP)	BGX(AMP)	AGX-(AMP)
213(AMP)	GDC-(AMP)	418(AMP)	TR/3216FF-(AMP)	BLF(AMP)	BAF-(AMP)
215(AMP)	S505-(AMP)	429(AMP)	3216FF(AMP)	BLN(AMP)	BAN-(AMP)
216(AMP)	GDA-(AMP)	431(AMP)	0603FA(AMP)	BLS(AMP)	BBS-(AMP)
217(AMP)	GDB-(AMP)	5140(AMP)	BAF-(AMP)	BMA(AMP)	GDA-(AMP)
218(AMP)	GDC-(AMP)	5170(AMP)	AGU-(AMP)	CBO(AMP) [4-160A]	HBO-(AMP)
221(AMP)	S505-V-(AMP)	523(AMP)	FNM-(AMP)	CCK(AMP) [1-300A]	ACK-(AMP)
226(AMP)	GDA-V-(AMP)	5HF(AMP)	GDA-(AMP)	CCL(AMP) [30-100A]	ACL-(AMP)
227(AMP)	GDB-V-(AMP)	5HFP(AMP)	GDA-V-(AMP)	CCLB(AMP) [20-250A]	KGJ-E-(AMP)
228(AMP)	GDC-V-(AMP)	5HT(AMP)	BK/S505-(AMP)A	CCLW(AMP) [1-300A]	KGJ-(AMP)
230(AMP)	BK/C515-(AMP)	5MF(AMP)	GMA-(AMP)	CCMR[1-30A Only]	LP-CC(AMP)
235(AMP)	GMA-(AMP)	5MFP(AMP)	GMA-V-(AMP)	CDNC(AMP)	CDN(AMP)
236(AMP)	GMA-V-(AMP)	5SF(AMP)	GDB-(AMP)	CDSC(AMP)	CDS(AMP)
238(AMP)	GMD-V-(AMP)	5ST(AMP)	GDC-(AMP)	CNL(AMP)	ANL-(AMP)
239(AMP)	GMD-(AMP)	6J(AMP)X	KTK-(AMP)	CNN(AMP)	ANN-(AMP)
251(AMP)	MCRW-(AMP)	6R(AMP)D	LPS-RK-(AMP)SP	DCT[1-15A]	PV-(AMP)A10F
252(AMP)	MCRW-(AMP)	702(AMP)	HVJ-(AMP)	E(AMP)FC	(AMP)FC
255(AMP) [1/16-5A]	MCRW-(AMP)	703(AMP)	HVL-(AMP)	E(AMP)FE	(AMP)FE
256(AMP)	MCRW-(AMP)	81200(AMP)ST	CBS-(AMP)	E(AMP)FET	(AMP)FET
257(AMP)	ATC-(AMP)	A70P(AMP)-1 or Type 1	FWP-(AMP)A14F	E(AMP)FM	(AMP)FM
275(AMP)	MCRW-(AMP)	A70P(AMP)-4 or Type 4	FWP-(AMP)A or B	E(AMP)FMM	(AMP)FMM
276(AMP)	MCRW-(AMP)	A70Q(AMP)-4 or Type 4	FWP-(AMP)A or B	E(AMP)LCT [6-20A]	(AMP)LCT
297(AMP)[AUTOMOTIVEFUSE]	ATM-(AMP)	A70QS(AMP)-14F	FWP-(AMP)A14F	E(AMP)LET [25-180A]	(AMP)LET
299(AMP)	MAX-(AMP)	A70QS(AMP)-22F	FWP-(AMP)A22F	E(AMP)LMMT [315-900A]	(AMP)LMMT
2AG220	BK/C517-(AMP)	A70QS[35-200]-4	FWP-(AMP)A or B	E(AMP)LMT [160-450A]	(AMP)LMT
2AG230	BK/C515-(AMP)	A70QS[225-400]-4 or 4K	FWP-(AMP)A or B	E100SF(AMP) [20-30A]	FWJ-(AMP)A14F
301(AMP)	AGA-(AMP)	A70QS[450-600]-4K	FWP-(AMP)A or B	E100S(AMP) [40-2000A]	FWJ-(AMP)
303(AMP)	AGW-(AMP)	A70QS[700-800]-4	FWP-(AMP)A or B	E15S(AMP) [35-3000A]	FWA-(AMP)A
307(AMP)	SFE-(AMP)	A50P(AMP)-1	FWH-(AMP)A14F	E15SF(AMP) [5, 10, 15, 20, 25, 30A]	FWA-(AMP)A10F
311(AMP)	AGC-(AMP)	A50P(AMP)-4	FWH-(AMP)A or B	E25S(AMP) [1000-2500A]	FWX-(AMP)AH
312(AMP)	AGC-(AMP)	A50QS(AMP)-4 or Type 4	FWH-(AMP)A or B	E25S(AMP) [35-800A]	FWX-(AMP)A
313(AMP)	MDL-(AMP)	A30QS(AMP)-1 or Type 1	FWX-(AMP)A14F	E25SF(AMP) [5-30A]	FWX-(AMP)14F
314(AMP)	ABC-(AMP)	A30QS[35-700]-4 or Type 4	FWX-(AMP)A	E50S(AMP)	FWH-(AMP)
315(AMP)	MDL-V-(AMP)	A30QS[1000-1200]-128	FWX-(AMP)AH	E50SF(AMP) [5-30A]	FWH-(AMP)14F
318(AMP)	AGC-V-(AMP)	A15QS[1-30]-2	FWA-(AMP)A10F	E70S(AMP)	FWP-(AMP)
322(AMP)	GBB-(AMP)	A15QS[35-60]-1	FWA-(AMP)A21F	ECK(AMP) [1-300A]	ACK-(AMP)
323(AMP)	MDA-(AMP)	A15QS[70-400]-4	FWA-(AMP)B	ECL(AMP) [30-100A]	ACL-(AMP)
324(AMP)	ABC-V-(AMP)	A2D(AMP)R	LPN-RK(AMP)SP	ECN(AMP)	FRN-R-(AMP)
325(AMP)	MDA-V-(AMP)	A2K(AMP)	KTN-R(AMP)	ECNR(AMP)	FRN-R-(AMP)
326(AMP)	MDA-(AMP)	A3T(AMP)	JUN(AMP)	ECS(AMP)	FRS-R-(AMP)
334(AMP)	GLD-(AMP)	A4BQ[225-600]	KRP-CL-(AMP)	ECSR(AMP)	FRS-R-(AMP)
336(AMP)	GBA-(AMP)	A4BQ[601-6000]	KRP-C-(AMP)SP	ELR(AMP)	GLR-(AMP)
361(AMP)	AGX-(AMP)	A4BT[601-4000]	KLU[601-4000]	ENLE(AMP)	ANL-(AMP)
362(AMP)	AGX-(AMP)	A4BY(AMP)	KLU(AMP)	ENNE(AMP)	ANN-(AMP)
3770(AMP)	SL-(AMP)	A4J(AMP)	JKS(AMP)	ERN(AMP)	REN-(AMP)
3780(AMP)	S-(AMP)	A6D(AMP)R	LPS-RK(AMP)SP	ERS(AMP)	RES-(AMP)
3785(AMP)	T-(AMP)	A6K(AMP)	KTS-R(AMP)	ESA(AMP)	S-(AMP)
3AB(AMP)	ABC-(AMP)	A6T(AMP)	JJS(AMP)	FA(AMP)	SA(AMP)
3ABP(AMP)	AGC-V-(AMP)	AG(AMP)	SC(AMP)	FI(AMP)	CGL-(AMP)
3AG(AMP)	AGC-(AMP)	AJT(AMP)	LPJ(AMP)SP	FIIC(AMP)	CGL-(AMP)
3AG311(AMP)	AGC-(AMP)	AM10/(AMP)	LP-CC-(AMP)	FIIM(AMP) [125-200A]	(AMP)M14CB
3AG312(AMP)	AGC-(AMP)	AOK(AMP)	ALS-(AMP)	FIIM(AMP) [80-100A]	(AMP)L09CB
3AG313(AMP)	MDL-(AMP)	ATDR(AMP)	LP-CC-(AMP)	FLA(AMP)	FNA-(AMP)
3AG315(AMP)	MDL-V-(AMP)	ATM(AMP)	KLM(AMP)	FLM(AMP)	FNM-(AMP)
3AG318(AMP)	AGC-V-(AMP)	ATMR(AMP)	KTK-R(AMP)	FLN(AMP)	FRN-R-(AMP)
3SB(AMP)	MDL-(AMP)	ATQ(AMP)	FNQ-(AMP)	FLNR(AMP)	FRN-R-(AMP)
3SBP(AMP)	MDL-V-(AMP)	ATQR(AMP)	FNQ-R-(AMP)	FLQ(AMP)	FNQ-(AMP)
401(AMP)	GMT-(AMP)A	BBC(AMP)	ABC-(AMP)	FLS(AMP)	FRS-R-(AMP)
411(AMP)	ABS-(AMP)	BDB(AMP)	GDB-(AMP)	FLSR(AMP)	FRS-R-(AMP)
412(AMP)	ABS-(AMP)	BDC(AMP)	GDC-(AMP)	GFN(AMP)	FNA-(AMP)

Competitor Fuse Family	Bussmann	Competitor Fuse Family	Bussmann	Competitor Fuse Blocks ^{1, 2, 3}	Bussmann
GGU(AMP)	AGU(AMP)	RF(AMP)	REN(AMP)	203(XX)	H25030-(X)CR*
GL10(AMP)	KTK-(AMP)	RFS(AMP)	RES(AMP)	206(XX)	H25060-(X)CR*
HCLR(AMP)	KTK-R-(AMP)	RLN(AMP)	REN-(AMP)	210(XX)	HM25100-(X)CR**
HCTR(AMP)	FNQ-R-(AMP)	RLS(AMP)	RES(AMP)	220(XX)	HM25200-(X)CR**
HSJ(AMP)	DFJ(AMP)	SAO(AMP)	SA-(AMP)	240(XX)	HM25400-(X)CR**
IDSR[6-60A Only]	FRS-R-(AMP)ID	SBS(AMP)	BBS-(AMP)	26(XX)	HM25600-(X)CR**
J(AMP)	JKS-(AMP)	SCL(AMP)	KTS-R-(AMP)	603(XX)	H60030-(X)CR*
JDL(AMP)	LPJ-(AMP)SP	SCLR(AMP)	KTS-R-(AMP)	606(XX)	H60060-(X)CR*
JFL(AMP)	JKS-(AMP)	SEC(AMP)	SC-(AMP)	610(XX)	HM60100-(X)CR**
JLLN(AMP)	JJN-(AMP)	SLC(AMP)	SC-(AMP)	620(XX)	HM60200-(X)CR**
JLLS(AMP)	JJS-(AMP)	SLO(AMP)	SL-(AMP)	640(XX)	HM60400-(X)CR**
JLS(AMP)	JKS-(AMP)	SOO(AMP)	S-(AMP)	66(XX)	HM60600-(X)CR**
JTD(AMP)	LPJ-(AMP)SP	TLO(AMP)	TL-(AMP)	203(XX)R	R25030-(X)CR*
KLA(AMP) [5, 10, 15, 20, 25, 30A]	FWA-(AMP)A10F	TOO(AMP)	T-(AMP)	206(XX)R	R25060-(X)CR*
KLB(AMP) [1-30A]	FWX-(AMP)A14F	TR(AMP)	FRN-R-(AMP)	210(XX)R	RM25100-(X)CR**
KL(AMP)	KAC-(AMP)	TRM(AMP)	FNM-(AMP)	220(XX)R	RM25200-(X)CR**
KLDR (AMP)	FNQ-R-(AMP)	TRS(AMP)	FRS-R(AMP)	240(XX)R	RM25400-(X)CR**
KLH(AMP) [1-30A]	FWH-(AMP)A14F	WOO(AMP)	W-(AMP)	26(XX)R	RM25600-(X)CR**
KLH(AMP) [225-600A]	FWH-(AMP)A			603(XX)R	R60030-(X)CR*
KLH(AMP) [35-200A]	FWH-(AMP)B			606(XX)R	R60060-(X)CR*
KLK(AMP)	KTK-(AMP)	Competitor Fuse Blocks ^{1, 2, 3}		610(XX)R	RM60100-(X)CR**
KLKR(AMP)	KTK-R-(AMP)	Bussmann		620(XX)R	RM60200-(X)CR**
KLLU(AMP)	KLU-(AMP)	LFJ60030(X) / (X)ID	J60030-(X)CR*	640(XX)R	RM60400-(X)CR**
KLMR(AMP)	LP-CC-(AMP)	LFJ60060(X) / (X)ID	J60060-(X)CR*	66(XX)R	RM60600-(X)CR**
KLNR(AMP)	KTN-R-(AMP)	LFJ60100(X) / (X)ID	JM60100-(X)CR**	US3J(X) / (X)I	CH30J(X) / (X)I
KLPC(AMP)	KRP-C-(AMP)SP	LFJ60200(X) / (X)ID	JM60200-(X)CR**	US6J(X) / (X)I	CH60J(X) / (X)I
KLSR(AMP)	KTS-R-(AMP)	LFJ60400(X) / (X)ID	JM60400-(X)CR**	USPV	CHPV
KLW(AMP)	FWA-(AMP)10F	LFJ60600(X) / (X)ID	JM60600-(X)CR**	USCC(X) / (X)I	CHCC(X)DU / (X)DIU
KON(AMP)	NON-(AMP)	LFR25030(X) / (X)ID	R25030-(X)CR*	USM(X) / (X)I	CHM(X)DU / CHM(X)DIU
KOS(AMP)	NOS-(AMP)	LFR25060(X) / (X)ID	R25060-(X)CR*	(R)6J30A(X)S	J60030-(X)CR*
L(AMP)TD	KRP-C-(AMP)SP	LFR25100(X) / (X)ID	RM25100-(X)CR**	(R)6J60A(X)B	J60060-(X)CR*
L15S(AMP) [1-30A]	FWA-(AMP)A10F	LFR25200(X) / (X)ID	RM25200-(X)CR**	R6J100A(X)B	JM60100-(X)CR**
L15S(AMP) [35-60A]	FWA-(AMP)A21F	LFR25400(X) / (X)ID	RM25400-(X)CR**	6J200A(X)BFBD	JM60200-(X)CR**
L15S(AMP) [70-400A]	FWA-(AMP)A	LFR25600(X) / (X)ID	RM25600-(X)CR**	6J400A(X)BFBD	JM60400-(X)CR**
L25S(AMP) [1-30A]	FWX-(AMP)A14F	LFR60030(X) / (X)ID	R60030-(X)CR*	6J600A(X)BFBD	JM60600-(X)CR**
L50S(AMP) [1-30A]	FWH-(AMP)A14F	LFR60060(X) / (X)ID	R60060-(X)CR*	R30A(X)(XX)	R25030-(X)CR*
L70S(AMP) [1-30A]	FWP-(AMP)A14F	LFR60100(X) / (X)ID	R60100-(X)CR**	R60A(X)(XX)	R25060-(X)CR*
LCU(AMP)	KTU-(AMP)	LFR60200(X) / (X)ID	RM60200-(X)CR**	R100A(X)B	RM25100-(X)CR**
LEN(AMP)	FRN-R-(AMP)	LFR60400(X) / (X)ID	RM60400-(X)CR**	R200A(X)BE	RM25200-(X)CR**
LENR(AMP)	LPN-RK-(AMP)SP	LFR60600(X) / (X)ID	RM60600-(X)CR**	R400A(X)B	RM25400-(X)CR**
LES(AMP)	FRS-R-(AMP)	LFH25030(X) / (X)ID	H25030-(X)CR*	R600A(X)B	RM25600-(X)CR**
LESR(AMP)	FRS-R-(AMP)	LFH25060(X) / (X)ID	H25060-(X)CR*	6R30A(X)(XX)	R60030-(X)CR*
LESRK(AMP)	LPS-RK-(AMP)SP	LFH25100(X) / (X)ID	HM25100-(X)CR**	6R60A(X)(XX)	R60060-(X)CR*
LGR(AMP)	GLR-(AMP)	LFH25200(X) / (X)ID	HM25200-(X)CR**	6R100A(X)B	RM60100-(X)CR**
LHR(AMP)	HLR(AMP)	LFH25400(X) / (X)ID	HM25400-(X)CR**	6R200A(X)BE	RM60200-(X)CR**
LKU(AMP)	KLU-(AMP)	LFH25600(X) / (X)ID	HM25600-(X)CR**	6R400A(X)B	RM60400-(X)CR**
LLNRK(AMP)	LPN-RK-(AMP)SP	LFH60030(X) / (X)ID	H60030-(X)CR*	6R600A(X)B	RM60600-(X)CR**
LLSRK(AMP)	LPS-RK-(AMP)SP	LFH60060(X) / (X)ID	H60060-(X)CR*	(R)F30A(X)(XX)	H25030-(X)CR*
MEN(AMP)	FNM-(AMP)	LFH60100(X) / (X)ID	HM60100-(X)CR**	(R)F60A(X)(XX)	H25060-(X)CR*
MEQ(AMP)	FNQ-(AMP)	LFH60200(X) / (X)ID	HM60200-(X)CR**	RF100A(X)B	HM25100-(X)CR**
MJS(AMP)	BK/C515-(AMP)	LFH60400(X) / (X)ID	HM60400-(X)CR**	F200A(X)BE	HM25200-(X)CR**
MOL(AMP)	BAF-(AMP)	LFH60600(X) / (X)ID	HM60600-(X)CR**	RF400A(X)B	HM25400-(X)CR**
MQ(AMP)	MCRW-(AMP)	LFPSJ30(X) / (X)ID	HM6030(X) / (X)I	F600A(X)B	HM25600-(X)CR**
NCL(AMP)	KTN-R-(AMP)	LFPSJ60(X) / (X)ID	CH30J(X) / (X)I	(R)6F30A(X)(XX)	H60030-(X)CR*
NCLR(AMP)	KTN-R-(AMP)		CH60J(X) / (X)I	(R)6F60A(X)(XX)	H60060-(X)CR*
NLN(AMP)	NON-(AMP)	LPHV	CHPV	R6F100A(X)B	HM60100-(X)CR**
NLS(AMP)	NOS-(AMP)	LPSC00(X) / (X)ID	CHCC(X)DU / (X)DIU	6F200A(X)BE	HM60200-(X)CR**
OT(AMP)	NON(AMP)	LPSM00(X) / (X)ID	CHM(X)DU / CHM(X)DIU	R6F400A(X)B	HM60400-(X)CR**
OTM(AMP)	BAF-(AMP)	6030(X)J	J60030-(X)CR*	6F600A(X)B	HM60600-(X)CR**
OTS(AMP)	NOS(AMP)	6060(X)J	J60060-(X)CR*	6SJ30A(X) / (X)I	CH30J(X) / (X)I
PICO	MCRW-(AMP)	610(XX)J	JM60100-(X)CR**	6SJ60A(X) / (X)I	CH60J(X) / (X)I
R224(AMP)	TR2/C518-(AMP)A	620(XX)J	JM60200-(X)CR**	6SC30A(X)-C / (X)I-C	CHCC(X)DU / (X)DIU
R230(AMP)	TR/C515-(AMP)A	640(XX)J	JM60400-(X)CR**	6SM30A(X)-C / (X)I-C	CHM(X)DU / CHM(X)DIU
R251(AMP)T1	TR/MCRW-(AMP)	66(XX)J	JM60600-(X)CR**		

* These Bussmann fuse blocks do not offer indication at this amperage, however a SAMI cover can be used to offer protection against accidental contact and open fuse indication.

** Finger-safe covers are available for this block along with optional open fuse indication.

1. Some competitor blocks are adder blocks and/or have multiple terminal offerings for Cu/Al or Cu only conductors. Bussmann blocks are not adder blocks below 100A, and all blocks are tin plated aluminum terminals to accommodate both Cu and Al conductors.

2. Wire ranges are not always the same. Please assure wire range is suitable for the application.

3. All blocks listed have a box lug for wire termination. Alternate connection types are available in the 30 and 60 amp range. If an alternate type is required, please see the appropriate Bussmann data sheet for part number ordering information.

Data Sheets are available online at www.cooperbussmann.com/DatasheetsEle. For technical assistance, contact the Bussmann Application Engineering Team. Call 636-527-1270 between 8:00 AM and 5:00 PM Central Time, or e-mail FuseTech@cooperindustries.com.

For customer assistance, call the Customer Satisfaction Team toll-free 855-BUSSMANN (855-287-7626) or e-mail BussCustSat@cooperindustries.com.



Easily Calculate Available Fault Current Anytime, Anywhere

FC² Mobile App Quickly Delivers Fault Current Calculations in the Palm of Your Hand

- Makes point-to-point calculations easy
- Calculate three-phase and single-phase faults
- Create and e-mail NEC[®] 110.24 compliant labels and one-line diagrams
- Fuse Sizing Guide assists with fuse and conductor sizing
- Works with or without a network connection
- Available for Apple and Android mobile devices
- FC² also available on-line in a web-based version

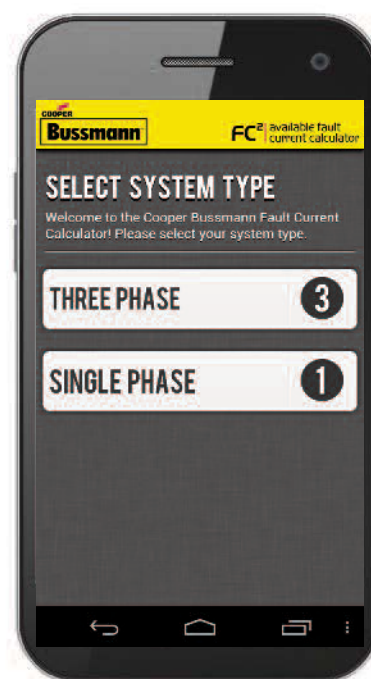

FC² available fault current calculator

One Tool for Easy Available Fault Current Calculations

How to Install:

- Use the QR Code with your device to download the mobile app



OR

- Go to the Android or Apple App store
- Search for “Fault Current Calculator” make sure to select the Bussmann FC² icon
- Click “install” and follow the instructions



How to Use:

1 Calculator – Calculate Available Fault Current

- Select either three-phase or single-phase
- Add components, calculate the system’s available fault current and review a one-line diagram
- E-mail one-line diagram at anytime

2 NEC® 110.24 Label – Helps Meet the Code

- Allows calculation of the maximum available fault current at the service equipment and provides date of calculation
- Create and e-mail a label once a calculation is complete
- Print and use label to post the maximum available fault current

3 User Guide – Helpful Tips

- Click “User Guide” to view helpful user tips
- Each page has explanations for performing calculations

4 Fuse Sizing Guide – For Main, Feeder and Branch Circuits

- Click “Fuse Sizing” and “VIEW FUSE SIZING DIAGRAM”
- Click each blue “HOT SPOT” link in the one-line diagram for fuse and conductor sizing information

5 Contact Us – Direct Contact to Industry Leading Support

- Click “Contact Us”
- For application inquiries, click “TECHNICAL SUPPORT”
- For all other questions, click “CUSTOMER SERVICE”
- The FC² app will automatically begin an e-mail to a Bussmann support representative

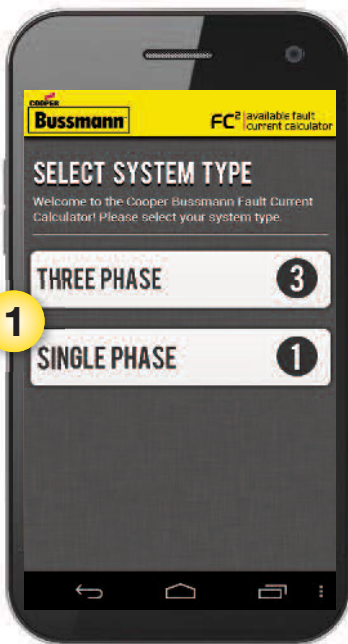

Index by Part Number

Catalog Number Index

Catalog Number	Page	Catalog Number	Page	Catalog Number	Page	Catalog Number	Page	Catalog Number	Page
_NZ01	255	1A1310	*	2608	*	3823	*	5623	*
_NZ02	255	1A1360	*	2610	*	3828	320	5672-	98
_BS	263	1A1478	*	2611	*	3833	*	5674-	98
_D125	255	1A1706-	436	2650	*	3835	321	5678	*
_D16	255	1A1837	*	2654	*	3835	326	5681-	97
_D27	255	1A1838	*	2698	*	3839	*	5682-	97
_D33	255	1A1853	*	270303	120	3959	*	5950	*
_LSC	263	1A1907-	96	2714	*	3998	*	5956-	98
NHG _ _ B	256-258	1A2294	*	2772	*	39E	*	5958	*
1025	*	1A3398-	96	2778	*	4121	*	5960-	98
11 Type	438	1A3399-	95	2795	*	4164	79	5961	*
11239	306	1A3400-	98	2834	*	4164-FR	79	5TPH	510
11240	306	1A3746	*	2837	*	4178	*	6125TD	*
11241	306	1A4533-	96	2838	*	4180	111	6374	*
11242	306	1A4534-	96	2839	*	4202	*	63A-DUMMY	*
11675-	329	1A4708	*	2860	*	4261	*	6415	*
11725-	329	1A4806	*	2989	*	4287	*	6417	*
11960	*	1A5018-	95	2992	*	4386	*	6418	*
13195	*	1A5600-	84	2A066	*	4393	320	6419	*
13926	*	1A5601-	95	2A8	*	4399	*	6420	*
14002-	331	1A5602-	95	2P25G	345	4402	*	64200	74
14004-	331	1A5603	*	3356	*	4405	319	6422	*
15087	436	1A5778	84	3375	*	4406	319	6424	*
15100-	432	1A5779	84	3411	*	4407	*	6427	*
15149	424	1A5780	84	3429	*	4408	*	64300	74
15188-3	362	1A5940	*	3434	*	4410	*	64913	*
15188-4	362	1A6049	*	3512	*	4412	*	64926	*
15242	*	1A8654	*	3513	*	4413	*	65372	*
15595	*	1B0048	*	3515	*	4421	321	65398	*
15600	*	1B0049	*	3519	*	4422	*	68100	*
15602	*	1BR021	*	3520	*	4423	*	68300	74
15660	*	1BR048	*	3521	*	4427	*	68600	74
15800	430	1BS1_ _ _	141, 213	3528	*	4428	*	7 Type	438
15900	*	1CIF	*	3531	*	4482	*	70 Series	436
15968	*	2004	*	3545	*	4512	*	74 Type	438
160_ _ _	329, 330	2081	*	3552	*	4513	*	75 Type	439
162_ _ _	329, 330	21010	*	3553	*	4514	*	76 Type	439
163_ _ _	327-328, 329, 330	2127	*	3554	*	4515	321	80 Type	439
165_ _ _	329, 330	2178	*	3555	*	4520	320	8414677	*
170E_ _ _ _	201-204, 207-211	2201	*	3556	*	4522	*	8588A81H	*
170F_ _ _ _	205-206	2245	*	3562	*	4525	*	9078A67G04	120
170H_ _ _ _	212-213	2322	*	3569	*	4528	111	9435	*
170L	*	24 Type	438	3571	*	4529	111	9483	*
170M_ _ _ _	145-199	2429	*	3572	*	4532	*	9732	*
170N	*	2430	*	3575	*	4535	*	9789	*
170R	*	2432	*	3576	*	4537	*	9834	*
170T	*	246B9949BG	*	3578	*	4561	*	9835	*
175GDMSJD	*	2487	*	3591	*	4567	*	9838	*
175GXQNJD	*	2499	319	3594	*	4574	319	9841	*
1976	*	25499	*	3595	*	4909	*	9843	*
1A0065	120	2601	*	3604	*	51215	*	A3354705	*
1A0835	*	2604	*	3723	321	51235	*	A3354710	120
1A1119-	96	2605	*	3742	321	5591-	98	A3354720	*
1A1120-	96	2607	*	3743	321	5592-	98	A3354730	120

* Not listed in this catalog. Call Cooper Bussmann Customer Satisfaction for more information. Toll-free phone: 855-287-7626 (855-BUSSMANN)

Catalog Number Index

Catalog Number	Page	Catalog Number	Page	Catalog Number	Page	Catalog Number	Page	Catalog Number	Page
A3354745	120	399, 402, 406, 408, 410		BSPH_WE	487-488, 491-492	C6344	*	DD	254
A404302	*	413-414, 419, 421, 423		BSPH_YPV	479-480	C7018	*	DDNS10	343
AAO	253	BAF	75	BSPH2A_D_LV	459-460	C7019	*	DDP30	338
ABC	91	BAN	*	BSPM_S2G	449-450	C7021-	376	DEO	253
ABCNA	108-109	BAO	253	BSPM_HLG	455-456	C7024-	377	DFJ	125
ABC-V	91	BB1P_	279-280	BSPM_S3G	451-452	CAV	108-109	DG100	340
ABGNA	109	BB3P_	279-280	BSPM_TN	467-468, 469-470	CAVH	108-109	DG150	340
ABS	*	BBS	77	BSPM_TNC	471-472	CBB	*	DG230	340
ABU	*	BBU-EFID	*	BSPM_WE	485-486	CBC	*	DG25	339
ABWNA	108	BC (fuse blocks)	305	487-488, 489-490, 491-492		CBF	*	DG35	339
AC	254	BC (fuses)	254	BSPM_WYG	453-454	CBP	*	DG60	339
ACB	*	BC_(separator)	259	BSPM_WYNG	455-456	CBS	*	DIA	*
ACF	*	BCA603	304	BSPM1A_D_LV	457-458	CBT	*	DIR_	388, 390, 392, 394
ACH	*	BCC	*	BSPM-DLG	453-454	CBU	*	396, 398, 402, 406, 408, 410	
ACK	*	BCF	*	BSPM-DLG	453-454	CCB	*	413-414	
ACL	*	BCPH2_PV	477-478	BSPM-DLG	453-454	CCG	*	DIS10	338
ACO	*	BD (fuses)	254	BSPM-DLG	453-454	CCP_	380-383	DKNSPS-	334,349
AD	254	BFW	*	BSPM-DLG	453-454	CCPB_	384-385	DKSPS_	335, 336, 343, 349
ADL	*	BG	305	BSPM-DLG	453-454	CCPHM_	381,383	DM20	337
ADLSJ	116	BGH	*	BSPM-DLG	453-454	CCSK-45	506	DM30	337
ADOSJ	116	BH- _ _ _ _	213	BSPM-DLG	453-454	CD	254	DM50	337
AF	*	BH_ _ xxx	141	BSPM-DLG	453-454	CD100	*	DP100	336
AFS	*	BH_ _ (fuseblocks)	306	BSPM-DLG	453-454	CD27	*	DP150	336
AFX	*	BM	305	BSPM-DLG	453-454	CDB	*	DP230	336
AGA	90	BMA603	304	BSPM-DLG	453-454	CDC	*	DP25	335, 338
AGC	91	BNQ21	365	BSPM-DLG	453-454	CDN	247	DP45	335
AGC-V	91	BOOR-508	413-414	BSPM-DLG	453-454	CDS	247	DP60	336
AGU	*	BPG_NPE	468	BSPM-DLG	453-454	CEO	253	DP60	336
AGW	90	BPG_NPEWE	486	BSPM-DLG	453-454	CFP_	510	DP60	336
AGX	90	BPH_D_LV	460	BSPM-DLG	453-454	CGL	248	DP60	336
AGX-V	*	BPH_YPV	478, 480	BSPM-DLG	453-454	CH10CL	*	DP60	336
AGY	*	BPM_IEC	468, 470, 472, 474	BSPM-DLG	453-454	CH10CM	*	DP60	336
AL-D	279	BPM_UL	450, 452, 454, 456	BSPM-DLG	453-454	CH14	277	DP60	336
ALS	*	BPM_WE	486, 488, 490, 492	BSPM-DLG	453-454	CH22	277	DP60	336
ALW	*	BPM_YPV	478, 480	BSPM-DLG	453-454	CH30J_	277, 281	DP60	336
AMG	*	BPMA_D_LV	458	BSPM-DLG	453-454	CH60J_	277, 281	DP60	336
AMI	*	BPP_SYPV	482	BSPM-DLG	453-454	CH8	274-277	DP60	336
AMWNA	108	BPS_IEC	462, 464, 466	BSPM-DLG	453-454	CHCC	274-277	DP60	336
ANL	79	BPS_NPEIEC	466	BSPM-DLG	453-454	CHM	274-277	DP60	336
ANN	79	BPSNPEIEC	470, 474	BSPM-DLG	453-454	CH-PLC	278	DP60	336
ASZ350B3	*	BPSNPEWE	488, 492	BSPM-DLG	453-454	CHPV	274-277	DP60	336
AT	*	BQE	365	BSPM-DLG	453-454	CIF	249	DP60	336
AT512 360		BQQ41	365	BSPM-DLG	453-454	CIH	251	DP60	336
ATC	82	BRKT_	349,353	BSPM-DLG	453-454	CIK	251	DP60	336
ATC-_ID	82	BRT	*	BSPM-DLG	453-454	CIL	251	DP60	336
ATC-FHID 82		BRW	*	BSPM-DLG	453-454	CJ	250	DP60	336
ATF	*	BSPD_DIN_	499-501	BSPM-DLG	453-454	CL1	222	DP60	336
ATM	82	BSPD48RJ45	497-498	BSPM-DLG	453-454	CM_CF	263	DP60	336
ATM-_ID	82	BSPD5BNCD_	493-494	BSPM-DLG	453-454	CP14002	*	DP60	336
ATM-_LP	82	BSPD5BNCSI	495-496	BSPM-DLG	453-454	CS_	259	DP60	336
ATM-FHID	83	BSPG_NPE	467-468	BSPM-DLG	453-454	CSC_	334, 335, 336, 337	DP60	336
B221	272	BSPH_TNS	473-474	BSPM-DLG	453-454	338,341,343,344,351,352		DP60	336
B222	272	BSPH_TT	469-470	BSPM-DLG	453-454	CT	218-219	DP60	336
BAC_	388, 391, 393, 395, 397	BSPH_TT	473-474	BSPM-DLG	453-454	CUG	*	DP60	336

* Not listed in this catalog. Call Cooper Bussmann Customer Satisfaction for more information. Toll-free phone: 855-287-7626 (855-BUSSMANN)

Catalog Number Index

Catalog Number	Page	Catalog Number	Page	Catalog Number	Page	Catalog Number	Page	Catalog Number	Page
ER12-_J3PB	418	FEH	259	GBA	78	HEF	*	HMR	*
ER12-_N3SB	420,422	FF	254	GBB	91	HEG	309	HN-1	*
ER12-800L3PB	418	FG	254	GBB-V	91	HEH	309	HN-5	*
ER3R-_J3PB	418	FHL	*	GBC	*	HEJ	310	HPC-D	318
ER3R-_N3SB	420, 422	FHN	*	GF	254	HET	310	HPD	317
ER3R-800L3PB	418	FL-	*	GFA	*	HEX	310	HPF	317
ER4-_J3JPB	418	FL11H_	117-119	GG	254	HEY	310	HPG	317
ER4-_N3SB	420, 422	FL11K_	117-119	GH	254	HEZ	310	HPL	*
ER4-800L3PB	418	FL11N	*	GKB	436	HFA	309	HPM	318
ER4P-_J3PB	418	FL11T_	117-119	GLD	78	HFB	308	HPS	317
ER4P-_N3SB	420, 422	FL12K_	117-119	GLN	*	HGA	*	HPS2	318
ER4P-800L3PB	418	FL1A5	*	GLP	263	HGB	*	HRE	309
ER4X-_J3PB	418	FL3H	*	GLQ	80	HGC	*	HRF	309
ER4X-_N3SB	420, 422	FL3K_	117-119	GLR	81	HHB	308	HRG	309
ER4X-800L3PB	418	FL3T_	117-119	GLX	*	HHC	82	HRH	309
ERK-28	507	FLB	*	GMA	89	HHD	82	HRI	309
ERS2	*	FLC_ 390, 392, 394, 396, 399	*	GMA-V	89	HHF	82	HRJ	309
ERS30	*	FLD	*	GMC	89	HHG	82	HRK	308
ESD	253	FLF	*	GMC-V	89	HHL	83	HSK	*
ET	218-219	FLH_ 390, 392, 394, 396, 399	*	GMD	89	HHM	83	HTB-	314-315
ETF	*	FLM	*	GMD-V	89	HHT	309	HTC-140M	95
F01A	*	FLN	*	GMF	81	HHX	83	HTC-15M	95
F02A	*	FLRM 390, 392, 394, 396, 399	*	GMQ	80	HIF	*	HTC-200M	95
F02B	*	FLS	*	GMT_	437	HJL	316	HTC-210M	95
F03A	*	FM	218, 221	GMW	*	HJM	*	HTC-30M	*
F03B	*	FM01A	*	GRF	81	HKA	*	HTC-35M	312
F09A	*	FM08A	*	GSK-260	506	HKL	316	HTC-40M	312
F09B	*	FM09A	*	GV_	284	HKP	313	HTC-45M	93
F10A	*	FM09B	*	H07C	252	HKQ	*	HTC-50M	93
F15A	*	FMM	218, 221	H12_		HKR	316	HTC-55M	312
F16A	*	FMX	*	388,390,392,394,396,398,408		HKT	316	HTC-70M	312
F520DDST	341	FNA	78	H25_	294-295	HKU	316	HVA	111
F520ST	341	FNM	76	H4X_		HKX	316	HVB	111
F520STLED	341	FNQ	76	388,390,392,394,396,398,402,4		HLD	316	HVJ	111
F520TOP	342	FNQ-R	24	06,408,410,413-414		HLQ	80	HVL	111
F60C	*	FNW	*	H60_	296-297	HLQ_	80	HVR	111
F61C	*	FP_	510	H79_		HLR	81	HVT	111
F62C	*	FPK_-3P	259	388,390,392,395,397,399,402		HLS	437	HVU	111
F63C	*	FRN-R	46	HAS-R	*	HLT	437	HVW	111
F64C	*	FRN-R-_ID	46	HBC	*	HM25100	289-293	HVX	111
F65C	*	FRS-R	47	HBH	94	HM25200	289-293	HWA	*
FA02	*	FRS-R-_ID	47	HBH-I	94	HM25400	289-293	IXL70F	*
FA2A	*	FT_	510	HBH-M	94	HM25600	289-293	J-_	511
FA4H	*	FTI	*	HBM	*	HM60100	289-293	J101/J	*
FBP	*	FTM	*	HBO	*	HM60200	289-293	J201/J	*
FC	*	FWA	126-129, 224-225	HBP-	*	HM60400	289-293	J301/J	*
FC_(fuse casing)	259	FWC	232-233	HBS-	*	HM60600	289-293	J60_	298
FCB	*	FWH	132-133, 228-231	HBV-I	94	HME	309	J70032	243
FCC	*	FWJ	139-140, 240-241	HBV-M	94	HMF	309	J70100	243
FCF	28-29	FWK	238-239	HBW-I	94	HMG	309	JB1	*
FCU	*	FWL	242	HBW-M	94	HMH	309	JCA	*
FDM	*	FWP	136-138, 234-237	HCM	*	HMI	309	JCD-	110
FE	218, 221	FWS	242	HEB	310-311	HMJ	309	JCG-	112
FEE	218, 221	FWX	130-131, 226-227	HEC	310	HMK	*	JCH-	112

* Not listed in this catalog. Call Cooper Bussmann Customer Satisfaction for more information. Toll-free phone: 855-287-7626 (855-BUSSMANN)

Catalog Number Index

Catalog Number	Page	Catalog Number	Page	Catalog Number	Page	Catalog Number	Page	Catalog Number	Page
JCI-	110	KBY	*	KQT	74	MCRW	*	NO.205	*
JCK-	112-114	KCF	74	KQV	74	MDA	92	NO.213	511
JCK-A-	112-114	KCH	74	KQW-M	*	MDA-V	92	NO.213-R 511	
JCK-B-	112-114	KCJ	74	KRP-C_SP	38-39	MDL	92	NO.216	511
JCL-	112-114	KCM	74	KRP-CL	39	MDL-V	92	NO.216-R	511
JCL-A-	112-114	KCM-B	74	KS-19392-L36	*	MDM	*	NO.220	508
JCL-B-	112-114	KCR	74	KT3	364	MDQ	92	NO.226	511
JCM	*	KCS	74	KT4	364	MDQ-V	92	NO.226-R	511
JCN	*	KCV	74	KTK	75	MFN	*	NO.242-R	511
JCP	*	KCY	74	KTK-R	25	MIC	78	NO.2621	511
JCQ-	110	KCZ	74	KTN-R	44	MIJ	*	NO.2621-R	511
JCR-A	112-114	KDA	74	KTN-S	*	MIN	78	NO.263	511
JCR-B-	112-114	KDB	74	KTS-R	45	MIS	79	NO.263-R	511
JCT-	110	KDC	74	KTS-S	*	MKB	*	NO.2641	511
JCU-	104	KDD	74	KTU	40	MMT	218, 220	NO.2641-R	511
JCW-	110	KDE	74	KU_(terminal blocks)	375	MSK-45	506	NO.2642	511
JCX-	103	KDF	74	KWN-R	*	MT	218, 220	NO.2661-R	511
JCY-	103	KDH	74	L09C	252	MT12	*	NO.2662-R	511
JCZ-	104	KDJ	74	L14C	252	MT12-1-2	358, 359, 360, 361 363, 364, 365	NO.2664-R	511
JDN	*	KDM	74	LAA	*	MTC6	358, 364	NO.270	508
JDZ-	104	KDP	74	LAC	*	MTMU	*	NO.36	507
JF1	*	KDR	74	LAG	*	MV055-	101	NO.4	509
JJN-	48	KDT	74	LAN	*	MV155-	102	NO.5	509
JJS-	49	KDU	74	LAR	*	N512	360	NO.6	509
JKS	36	KDY	74	LCT	215-216	NBB	*	NO.616	511
JM60100	289-293	KEF	*	LEF	*	NBC	*	NO.616-R	511
JM60200	289-293	KEM	*	LET	215-216	NBE	*	NO.626	511
JM60400	289-293	KER	*	LKB	*	NC3 361		NO.626-R	511
JM60600	289-293	KEW	74	LKC	*	ND-1260	*	NO.642-R	511
JN_	358, 359, 360, 361 362, 363, 364	KEX	74	LKN	*	NDN1	359	NO.663	511
JNDN3	358	KFH-A	74	LKS	*	NDN111 359		NO.663-R	511
JP600	299	KFM	74	LMMT	215, 217	NDN3 358		NO.7	509
JPA-3	*	KFT	74	LMT	215, 217	NDN63 358		NO.8	509
JSK-36	506	KFZ	74	LP-CC	23	NDND1	*	NON	37
JT	286-287	KGC	*	LPJ_SP	35	NDNF1-WH	322	NOS	37
JTN	286-287	KGJ	*	LPJ_SPI	35	NDNFD1-WH	322	NPL	*
JU	*	KGJ-A	*	LPN-RK_SP	41-43	NDNLFD1-WH	322	NRA Series	353, 358, 359 360, 361, 362, 363, 365
K07C	252	KGJ-E	*	LPN-RK_SPI	41-43	NDNV4 358		NSD	253
KAB	*	KGL	*	LPRK-28	507	NFA	*	NSE3	361
KAC	134	KGO-E	*	LPS-RK_SP	41-43	NFT2 360		NSS3	361
KAD	364	KGS	*	LPS-RK_SPI	41-43	NFT3 360		NTN-R_	511
KAD	*	KGS-A	*	LPT	*	NFTA Series	353, 358, 359 360, 361, 362, 363, 365	NTQ23	365
KAF	*	KGT	*	LUG1-_	398, 408	NI	263	NTS-R_	511
KAJ	*	KGX	*	LUG2-_	398, 408	NITD	253	NUE	*
KAL	*	KIG	74	LUG3-_	408	NNB	511	NXA	*
KAW	*	KIT-6POLE	413, 415	LUG5-_	402, 410	NNB-R	511	NXC	*
KAX	*	KJA	*	M09C	252	NNC	511	OIA	*
KAZ	79	KLC	*	MAI	222	NO.1	409	OJ	*
KBC	135	KLM	75	MAS	*	NO.100	*	OPM-1038	282-283
KBD	*	KLP	*	MAX-	83	NO.140	508	OPM-NG	284-285
KBJ	*	KLU	40	MAX-_ID	83	NO.2	509	OSD	253
KBR	*	KMH-C	*	MB-	52	NO.201	*	P-	51
KBT	*	KPF	74	MBO	*			P09C	252
		KQO	74	MC_ _ _	222				

* Not listed in this catalog. Call Cooper Bussmann Customer Satisfaction for more information. Toll-free phone: 855-287-7626 (855-BUSSMANN)

Catalog Number Index

Catalog Number	Page	Catalog Number	Page	Catalog Number	Page	Catalog Number	Page	Catalog Number	Page
P11C	252	RD100_	404-406, 420	SC	34	SSU	307	TP15914	428
P20S	344	RD1000_	404-405, 410	SCV15	*	SSW	307	TPA	429
P25G	345	RD100-3-SCCR	404-405, 408	SCV20	*	SSX	307	TPA-B	429
P30S	344	RD1200_	404-405, 410, 420	SCY	307	SSY	307	TPB	*
P65S	344	RD16_	412-414, 422	SD_-S	63, 67	STD	253	TPC	426
PCB	*	RD200_	404-405, 408, 420	SF25H	*	STI	*	TPCDS	426
PCC	*	RD25_	412-414, 422	SFB1030	*	STM	*	TPH	*
PCD	*	RD30_	404-406, 420	SFC-_	510	STY	307	TPHCS-_	433
PCF	*	RD40_	412-414, 422	SFD27	*	T-	51	TPJ	*
PCG	*	RD400_	404-405, 408, 420	SFE	*	T30_	300-301	TPL-_	434
PCH	*	RD60_	404-406, 420	SFR	*	T60_	302-303	TPM	427
PCI-	*	RD600_	404-405, 410, 420	SFR1	*	TB_-D	259	TPMDS	427
PCT	437	RD63_	412-414, 422	SH1-_	388	TB00_	259	TPN_	435
PDB_	324, 226	RD80_	412-414, 422	SH2-_	388	TB100-	366-367	TPS	430
PDBFS_	324-325	RD800_	404-405, 410, 420	SH4-_	406, 413-414	TB200-	368-369	TPSFH_	510
PLK3	364	RDF100_	387, 396, 418	SH5-_	390, 392, 394, 396	TB300-	370-371	TPW	*
PLU1	363	RDF200_	387, 398, 418		398, 408	TB345-	370-371	TPWDS	*
PLU3	362	RDF30_	387-390, 418	SH6-_	410	TB400-	374	TRF	*
PMP	268-269	RDF400_	387, 398, 418	SH7-_	402	TC	51	TSH_-	399, 402, 406, 409
POLE-_	413, 415	RDF60_	387, 392-394, 418	SH-GUIDE _	406, 408, 410	TCF	26-27	411, 413, 415, 419, 421, 423	
POLE98-_	406	RDF600_	387, 402, 418		413-414	TCF_RN	26-27	TVS_	504
PON	247	RDF800_	387, 402, 418	SKA	307	TCFH_N	32-33	TVSS-	*
PS	268-269	REG	*	SL-	50	TCFH_NW	32-33	TXLEJ	116
PS1RPLSW	*	REN	*	SL_	259	TCP	*	TXMEJ	116
PSU1	363	RES	*	SNL-7K	*	TDC	*	TXQEJ	116
PV-	60	RFL	*	SOU	307	TDC10	*	UHA	*
PV-_01XL	63	RK1SK-39	506	SOW	307	TDC11	*	UHC	*
PV-_01XL15	67-69	RK5SK-39	506	SOX	307	TDC180	*	UHJ	*
PV-_10_	60	RLA	*	SOY	307	TDC600	*	UHS	*
PV-_14F	61	RLC	*	SP_	259	TDLEJ	116	UHT	*
PV-_14LF	66	RYA	*	SPH50SP_	PN442-445	TDLSJ	116	UHW	*
PV-_1XL	63-64	RYC	*	SPH50SP_	PNG442-445	TDMEJ	116	ULR	*
PV-_2XL	63-64	S-	51	SPH50SP_	SN442-445	TDQSJ	116	VFNHA	115
PV-_2XL-15	67-69	S500	87	SPH50SP_	SNG442-445	TFC	*	VKNHA	115
PV-_3L	63-64	S500-V	87	SPH50SP_	WYG 442-445	TFF	*	W-	50
PV-_3L-15	67-69	S501	87	SPH50SP_	WYGN 442-445	TFL	*	WCF	30-31
PV-_NH1	62	S501-V	87	SPH50SP_	HLG 442-445	TFLSJ	116	WCF_RN	30-31
PVCF	57-58	S505	87	SPH50SP_DLG	442-445	TFMEJ	116	WDFHO	115
PVM	56	S505H	88	SPJ	*	TFQSJ	116	WDLSJ	115-116
PVS-R	59	S505H-V	88	SPOD_	502-503	TGH	*	WDOH6	115
PWR1PLP	279-280	S505-V	87	SPP	*	THLEJ	116	WDOSJ	116
PWR35MM	279-280	S506	88	SPP40SP_DLG	446-448	THMEJ	116	WER	438
PWR50MM	279-280	S506-V	88	SPP40SP_PN	446-448	TI_	222	WFFHO	115
QC202/J	*	S-8001	319	SPP40SP_SN	446-448	TIQ	*	WFLSJ	115-116
QC203/J	*	S-8002	319	SPP40SP_WYG	446-448	TJD	*	WFMSJ	115
Quik-Spec AC Safety Switch		S-8101	319	SRD	*	TKLEJ	116	WFNHO	115
	271	S-8102	319	SRT-A	*	TKMEJ	116	WFOH6	115
Quik-Spec Coordination		S-8201	319	SRU	307	TL-	50	WFOSJ	116
Panelboards	266-267	S-8202	219	SRU-BC	*	TM2_	334, 335, 336, 337	WGA	*
Quik-Spec DC Safety Switches		S-8203	319	SRW	307		338, 341, 343, 344, 345	WHA	*
	270	S-8301	319	SRX	307		354-357	WHN	*
R11C	252	SA-	52	SRY	307	TP158HC	431	WIE	*
R25_	294-295	SAMI-	288	SSD	253	TP15900	*	WJON6 115	
R60_	296-297	SB_	259	SSN	307	TP15900-4_429		WKB	*

* Not listed in this catalog. Call Cooper Bussmann Customer Satisfaction for more information. Toll-free phone: 855-287-7626 (855-BUSSMANN)

Catalog Number Index

Catalog Number	Page	Catalog Number	Page	Catalog Number	Page	Catalog Number	Page	Catalog Number	Page
WKFHO	115	WZX	*						
WKH	*	XL25X	*						
WKJ	*	XL50F	*						
WKK	*								
WKL	*								
WKLSJ	116								
WKMSJ	115-116								
WKNHO	115								
WKS	*								
WKU	*								
WKV	*								
WLF	*								
WMB	*								
WMM	*								
WMQ	*								
WPQ	*								
WQN	*								
WQP	*								
WSE	*								
WSH	*								
WSL	*								
WSM	*								
WSQ	*								
WST	*								
WSU	*								
WTJ	*								
WTK	*								
WTT	*								
WTZ	*								
WUE	*								
WUG	*								
WUH	*								
WUI	*								
WUQ	*								
WUR	*								
WUU	*								
WUV	*								
WUW	*								
WUY	*								
WVA	*								
WVQ	*								
WVR	*								
WWD	*								
WWE	*								
WWG	*								
WWI	*								
WWK	*								
WWU	*								
WWV	*								
WWX	*								
WYM	*								
WZC	*								
WZJ	*								
WZK	*								

* Not listed in this catalog. Call Cooper Bussmann Customer Satisfaction for more information. Toll-free phone: 855-287-7626 (855-BUSSMANN)

Sales Support & Manufacturing Facilities

North America

Bussmann Business Headquarters

114 Old State Road
Ellisville, Missouri 63021
Telephone: 636-527-3877
Fax: 800-544-2570
Email: fusebox@cooperindustries.com

Bussmann Mexico

Poniente 148 #933
Col. Industrial Vallejo
Azcapotzalco C.P. 02300,
Mexico D.F.
Telephone: +52-5587-0211 Ext.720
01-800-8-FUSEMX (387369)
Fax: +52-55-5567-1131
E-mail: ventasbussmannmexico@cooperindustries.com

Bussmann Transportation

10955 SW Avery St.
Tualatin, OR 97062
Telephone: 503-692-5360
Fax: 503-692-9091
E-mail: SurePower.Sales@cooperindustries.com

Bussmann Electronics

1225 F Broken Sound Parkway NW
Boca Raton, FL 33487
Telephone: 561-988-4100
Fax: 561-241-6640
E-mail: customerservice@cooperindustries.com

Asia

Cooper Electric (Shanghai) Co. Ltd.

955 Shengli Road Heqing Pudong, Shanghai 201201
China
Telephone: 8621-2899-3888
Fax: 8621-2899-3997

Bussmann India

Bussmann, India, Pvt. Ltd.
2, EVR Street,
Sedarpet Indl. Estate,
Pondicherry – 605 111
India
Telephone: 91-413-267-2005
Fax: 91-413-267-8182
E-mail: sales.india@cooperindustries.com

Europe

Cooper (UK) Ltd.

Melton Road
Burton-on-the-Wolds
Leicestershire LE12 5TH
England
Telephone: 44-1509-882737
Fax: 44-1509-882786
E-mail: bule.sales@cooperindustries.com

South America

Bussmann Brazil

Bussmann do Brasil Ltda.
Rodovia Santos Dumont, km 23
13.300-000, Caixa Postal 095
Itu Sao Paulo
Brazil
Telephone: 55-11-4024-8400
Fax: 55-11-40-24-8424

Bussmann Fuse Cross Reference & Low-Peak™ Upgrade

The left column represents Bussmann and competitors' part numbers. The right column represents the Bussmann upgrades.

The Bussmann fuse upgrade offers superior performance while reducing the number of SKUs that need to be in stock. Low-Peak™ fuses feature a high degree of current limitation, which will provide the best component protection and may reduce the arc flash hazard. Listings are alpha-numerical by fuse class and fuse catalog symbol.

This list is only a consolidated cross reference to some of our most common products. For a much more extensive database please consult the *Product Profiler* competitor cross-reference. Just visit www.cooperbussmann.com and click on the magnifying glass icon in the upper right corner.

Class CC and Midget	
Existing Fuse	Low-Peak™ Upgrade
A6Y (type 2B)	LP-CC
ABU	
AGU	
ATDR	
ATM	
ATMR	
ATQ	
BAF	
BAN	
BLF	
BLN	
CCMR	
CM	
CMF	
CNM	
CNQ	
CTK	
CTK-R	
FLM	
FLO	
FNM	
FNQ	
GGU	
HCLR	
KLK	
KLK-R	
KTK	
KTK-R	
MCL	
MEN	
MEQ	
MOF	
MOL	
OTM	
TRM	
6JX	LP-CC
*FNQ-R suggested on primary of control transformers.	
ATQR	
FNQ-R	FNQ-R
KLDR	



Class J	
Existing Fuse	Low-Peak™ Upgrade
A4J	LPJ_SP
AJT	
CJ	
CJS	
GF8B	
HRCXXJ	
J	
JA	
JCL	
JDL	
JFL	
JHC	
JKS	
JLS	
JTD	LPJ_SP



Class L	
Existing Fuse	Low-Peak™ Upgrade
A4BQ	KRP-C_SP
A4BT	
A4BY	
A4BY (type 55)	
CLASS L	
CLF	
CLL	
CLU	
HRC-L	
KLLU	
KLPC	
KLU	
KTU	
L	
LCL	
LCU	KRP-C_SP



250 Volt Class R	
Existing Fuse	Low-Peak™ Upgrade
A2D	LPN-RK_SP
A2D-R	
A2K	
A2K-R	
A2Y (type 1)	
AT-DE	
CHG	
CRN-R (type 3)	
CTN-R	
DEN	
DLN	
DLN-R	
ECN	
ECN-R	
ERN	
FLN	
FLN-R	
FRN	
FRN-R	
FTN-R	
GDN	
HAC-R	
HB	
KLN-R	
KON	
KTN-R	
LENRK	
LKN	
LLN-RK	
LON-RK	
NCLR	
NLN	
NON	
NRN	
OTN	
REN	
RFN	
RHN	
RLN	
TR	
655	
660	
10KOTN	
50KOTN	LPN-RK_SP



600 Volt Class R	
Existing Fuse	Low-Peak™ Upgrade
A6D	LPS-RK_SP
A6K-R	
A6X (type 1)	
ATS-DE	
CHR	
CTS-R	
DES	
DES-R	
DLS	
DLS-R	
ECS-R	
ERS	
FLS	
FLS-R	
FRS	
FRS-R	
FTS-R	
GDS	
HA	
KLS-R	
KOS	
KTS-R	
LES	
LES-R	
LES-RK	
LKS	
LLS-RK	
LOS-RK	
NLS	
NOS	
NRS	
OTS	
RES	
RFS	
RHS	
RLS	
SCLR	
TRS	
TRS-R	
656	
10KOTS	
50KOTS	LPS-RK_SP



The comparative catalog numbers shown were derived from the latest available published information from various manufacturers. Because competitors' products may differ from Bussmann products, it is recommended that each application be checked for required electrical and mechanical characteristics before substitutions are made. Bussmann is not responsible for misapplications of our products. Overcurrent protection is application dependent. Consult the latest catalogs and application literature, or contact our Application Engineering Department toll free at 855-287-7626 (855-BUSSMANN).

Customer Assistance

Customer Satisfaction Team

Available to answer questions regarding Bussmann products & services Monday-Friday, 7:00 a.m. – 6:00 p.m. Central Time. Contact:

- Toll-free phone: 855-287-7626 (855-BUSSMANN)
- Toll-free fax: 800-544-2570
- E-mail: busscustsat@cooperindustries.com

Emergency and After-Hours Orders

Next flight out or will call shipment for time-critical needs. Customers pay only standard product price, rush freight charges, & modest emergency service fee. Place these orders through the Customer Satisfaction Team during regular business hours. For after-hours, contact:

- After hours 314-995-1342

C3 – the Enhanced, Online Cooper Customer Center

Provides real time product availability, net pricing, order status & shipment tracking for: B-Line, Bussmann, Crouse-Hinds, Lighting, Power Systems & Wiring Devices. Call 877-995-5955 for log-in assistance. Available at:

- www.cooperc3.com

Application Engineering

Technical assistance is available to all customers. Application support is available Monday-Friday, 7:00 a.m. – 5:00 p.m. Central Time. Contact:

- Toll-free phone: 855-287-7626 (855-BUSSMANN)
- E-mail: fusetech@cooperindustries.com

Online Resources

Visit www.cooperbussmann.com for the following resources:

- Product search & cross-reference
- Product & technical materials
- Solutions centers for information on topical issues including arc flash, selective coordination & short-circuit current rating
- Technical tools, like our arc flash calculator
- Where to purchase Bussmann product

Eaton's Bussmann Business
PO Box 14460
St. Louis, MO 63178-44602
www.bussmann.com

Your authorized distributor is:

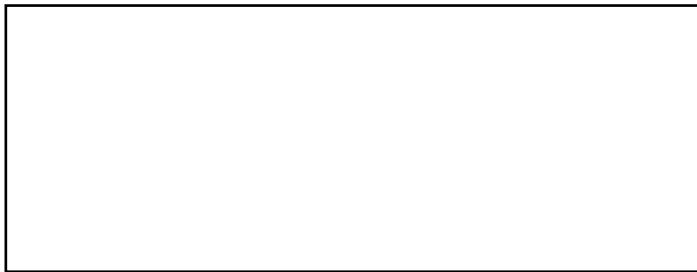

Eaton
1000 Eaton Boulevard
Cleveland, OH 44122
United States
Eaton.com

© 2013 Eaton
All Rights Reserved
Printed in USA
Publication No.1007
August 2013

Eaton is a registered trademark.

All other trademarks are property of their respective owners.