

LOC		DIST		REVISIONS			
P	LTR	DESCRIPTION		DATE	DWN	APVD	
	J	REVISED PER ECO-19-018195		20OCT2020	D.S	H.L	

NOTE:

- MATERIAL:
 HOUSING: PA9T, UL94 V-0, COLOR: (SEE TABLE).
 CONTACTS: BRASS.
 CAP: LCP UL94 V-0, COLOR :BLACK.
- FINISH:
 CONTACTS: 3.05um [120u"] MIN. MATTE-TIN.
 1.27um [50u"] MIN. NICKEL UNDERPLATED ALL OVER.
- WAVE SOLDER CAPABLE TO 265°C PER TEST SPEC.
 109-202, CONDITION B.
- NO TE LOGO AND DATE CODE ON THE PRODUCT WITH 4 POS.
- THE KEY IDENTIFIED WAS SHOWN ON PAGE 5.

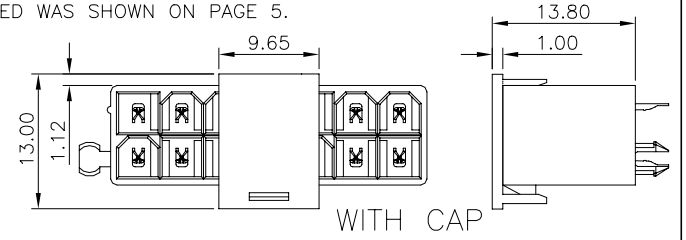
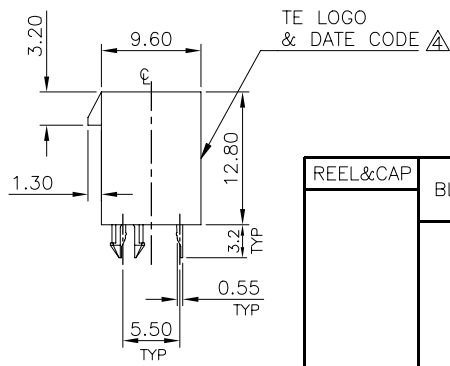
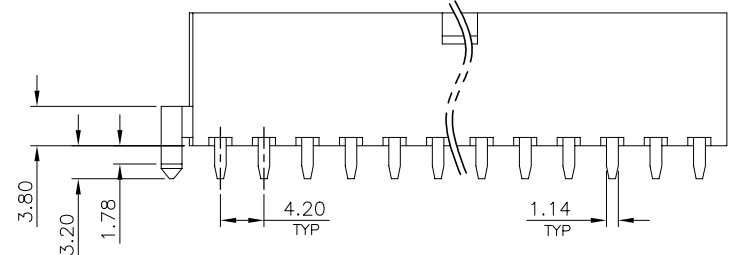
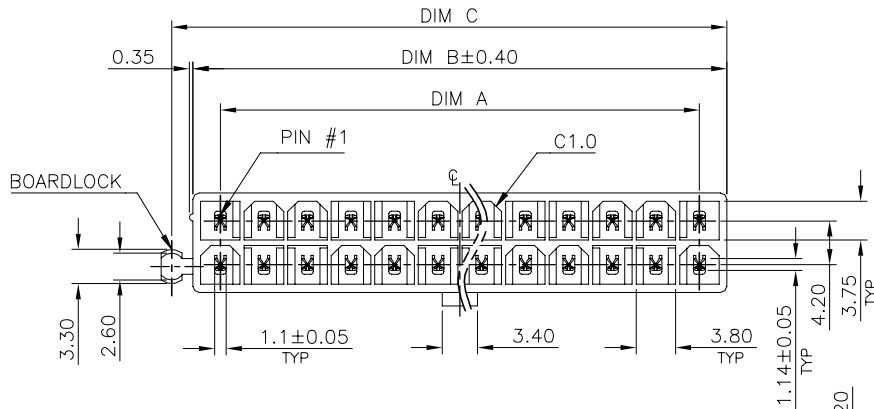

REEL&CAP	BLACK PA9T	3.11	25.2	30.5	32.55	14	6-1775099-9
TRAY	IVORY PA9T	1.52	8.4	13.7	15.75	6	6-1775099-6
		5.40	46.2	51.5	53.55	24	1-1775099-3
		1.13	4.2	9.5	11.55	4	1-1775099-2
		4.30	37.8	43.1	45.15	20	1-1775099-1
		3.90	33.6	38.9	40.95	18	1-1775099-0
		3.11	25.2	30.5	32.55	14	1775099-9
		2.71	21.0	26.3	28.35	12	1775099-8
		2.31	16.8	22.1	24.15	10	1775099-7
		1.52	8.4	13.7	15.75	6	1775099-6
		1.92	12.6	17.9	19.95	8	1775099-5
TRAY	IVORY PA9T	5.40	46.2	51.5	53.55	24	1775099-4
		1.13	4.2	9.5	11.55	4	1775099-3
TRAY	TRANSPARENCY PA9T	5.40	46.2	51.5	53.55	24	1775099-2
		1.13	4.2	9.5	11.55	4	1775099-1
PACKAGE	HSG COLOR & MATERIAL	WEIGHT	DIM A	DIM B	DIM C	POS.	PART NUMBER

SUPERSEDED TO 1-1775099-3
 SUPERSEDED TO 1-1775099-2
 OBSOLETE

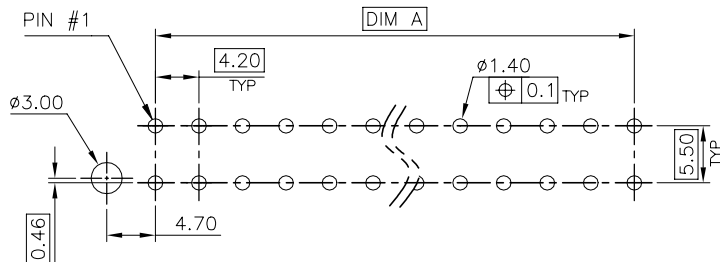

RECOMMENDED PCB LAYOUT
 TOLERANCE: ±0.05 T=1.6mm

ONE BOARDLOCK
 (LEFT)

THIS DRAWING IS A CONTROLLED DOCUMENT.

DIMENSIONS: mm	TOLERANCES UNLESS OTHERWISE SPECIFIED:	DWN B. HSING 15JUL2009	TE Connectivity ATX POWER CONNECTOR 4.2mm PITCH, VERTICAL, DIP TYPE
	0 PLG ± -	CHK S. CHIEN 15JUL2009	
	1 PLG ± 0.3	APVD W. KODAMA 15JUL2009	
	2 PLG ± 0.2	NAME	
MATERIAL SEE NOTE	FINISH SEE NOTE	PRODUCT SPEC 108-57560	SIZE A3 CAGE CODE 00779 C=1775099
		APPLICATION SPEC	DRAWING NO
		WEIGHT SEE TABLE	RESTRICTED TO
		CUSTOMER DRAWING	SCALE SHEET 1 OF 7 REV J

LOC		DIST		REVISIONS			
P	LTR	DESCRIPTION		DATE	DWN	APVD	
DW				SEE SHEET 1.			

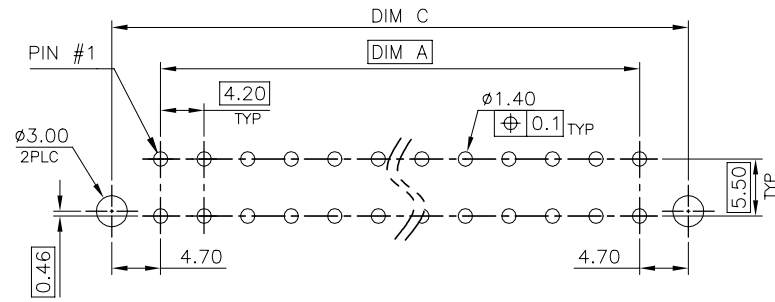
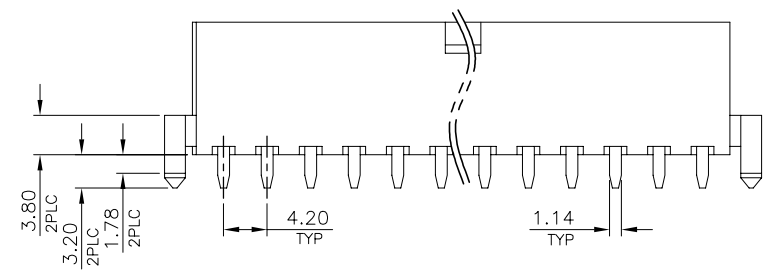
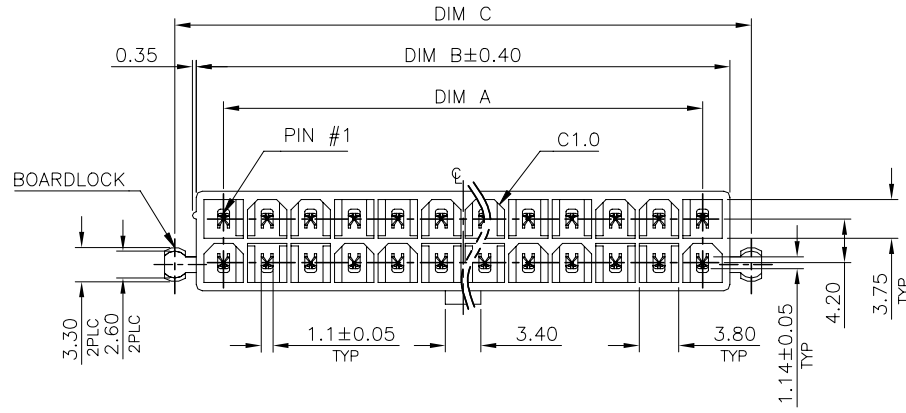

RECOMMENDED PCB LAYOUT
 TOLERANCE: ±0.05 T=1.6mm

- NOTE:
- MATERIAL:
HOUSING: PA9T, UL94 V-0, COLOR: (SEE TABLE).
CONTACTS: BRASS.
 - FINISH:
CONTACTS: 3.05um [120u"] MIN. MATTE-TIN.
1.27um [50u"] MIN. NICKEL UNDERPLATED ALL OVER.
 - WAVE SOLDER CAPABLE TO 265°C PER TEST SPEC.
109-202, CONDITION B.
 - NO TE LOGO AND DATE CODE ON THE PRODUCT WITH 4 POS.
 - THE KEY IDENTIFIED WAS SHOWN ON PAGE 5.
 - PACKING WITH TRAY.

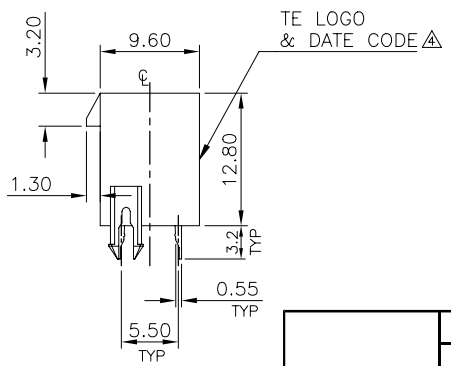

TWO BOARDLOCK

HSG COLOR & MATERIAL	WEIGHT	DIM A	DIM B	DIM C	POS.	PART NUMBER
IVORY PA9T	3.54	29.4	34.7	38.8	16	2-1775099-9
	5.43	46.2	51.5	55.6	24	2-1775099-8
	4.33	37.8	43.1	47.2	20	2-1775099-7
	3.93	33.6	38.9	43.0	18	2-1775099-6
	3.14	25.2	30.5	34.6	14	2-1775099-5
	2.74	21.0	26.3	30.4	12	2-1775099-4
	2.34	16.8	22.1	26.2	10	2-1775099-3
	1.95	12.6	17.9	22.0	8	2-1775099-2
	1.55	8.4	13.7	17.8	6	2-1775099-1
	1.16	4.2	9.5	13.6	4	2-1775099-0

THIS DRAWING IS A CONTROLLED DOCUMENT.

DIMENSIONS: mm	TOLERANCES UNLESS OTHERWISE SPECIFIED:	DWN	TE Connectivity		
	0 PLC ± -	CHK	NAME		
	1 PLC ± 0.3	APVD	ATX POWER CONNECTOR		
	2 PLC ± 0.2	PRODUCT SPEC	4.2mm PITCH, VERTICAL, DIP TYPE		
	3 PLC ± 0.15	APPLICATION SPEC	SIZE	CAGE CODE	DRAWING NO
MATERIAL	4 PLC ± -	WEIGHT	A3	00779	C=1775099
	ANGLES ± 3'	CUSTOMER DRAWING	RESTRICTED TO		
		SCALE	SHEET	2 OF 7	REV J

THIS DRAWING IS UNPUBLISHED. RELEASED FOR PUBLICATION
 © COPYRIGHT 2010 BY TYCO ELECTRONICS CORPORATION. ALL RIGHTS RESERVED.

LOC		DIST		REVISIONS			
P	LTR	DESCRIPTION		DATE	DWN	APVD	
SEE SHEET 1.							

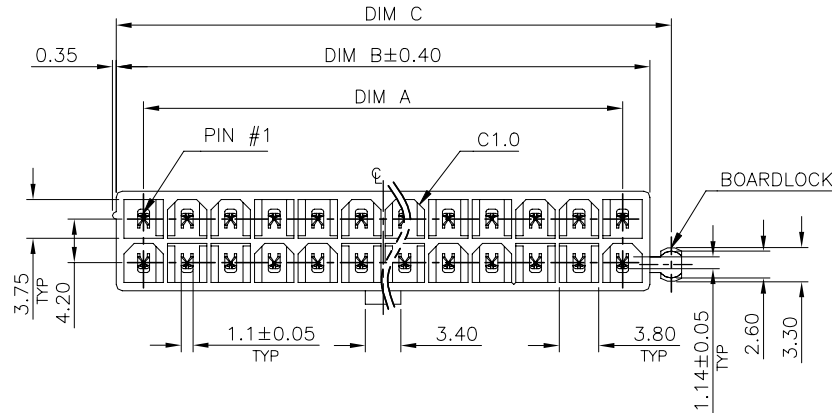

- NOTE:
- MATERIAL:
HOUSING: PA9T, UL94 V-0, COLOR: (SEE TABLE).
CONTACTS: BRASS.
 - FINISH:
CONTACTS: 3.05um [120u"] MIN. MATTE-TIN.
1.27um [50u"] MIN. NICKEL UNDERPLATED ALL OVER.
 - WAVE SOLDER CAPABLE TO 265°C PER TEST SPEC.
109-202, CONDITION B.
 - NO TE LOGO AND DATE CODE ON THE PRODUCT WITH 4 POS.
 - THE KEY IDENTIFIED WAS SHOWN ON PAGE 5.
 - PACKING WITH TRAY.

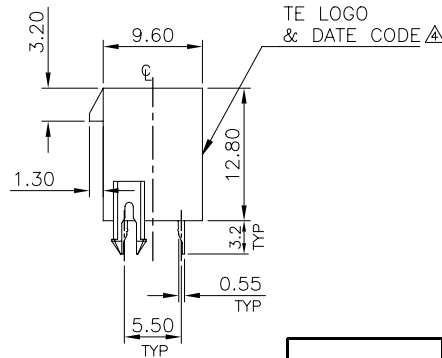
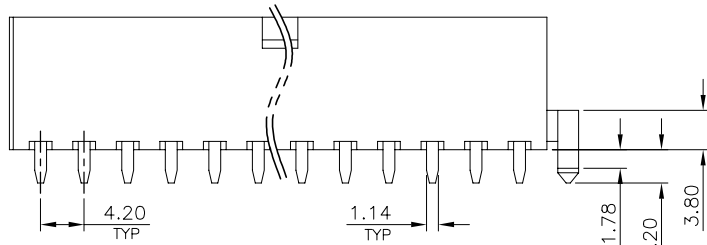

ONE BOARDLOCK (RIGHT)

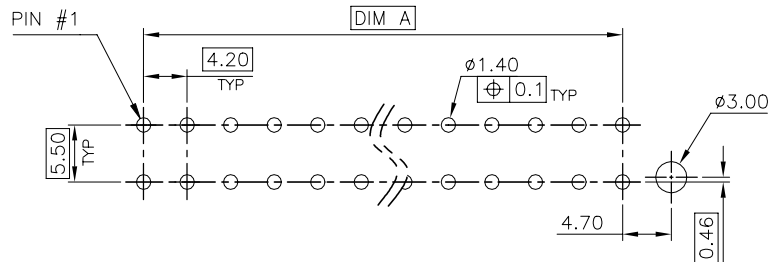

RECOMMENDED PCB LAYOUT
 TOLERANCE: ±0.05 T=1.6mm

IVORY PA9T	5.40	46.2	51.5	53.55	24	3-1775099-8
	4.30	37.8	43.1	45.15	20	3-1775099-7
	3.90	33.6	38.9	40.95	18	3-1775099-6
	3.11	25.2	30.5	32.55	14	3-1775099-5
	2.71	21.0	26.3	28.35	12	3-1775099-4
	2.31	16.8	22.1	24.15	10	3-1775099-3
	1.92	12.6	17.9	19.95	8	3-1775099-2
	1.52	8.4	13.7	15.75	6	3-1775099-1
1.13	4.2	9.5	11.55	4	3-1775099-0	
HSG COLOR & MATERIAL	WEIGHT	DIM A	DIM B	DIM C	POS.	PART NUMBER

THIS DRAWING IS A CONTROLLED DOCUMENT.

DIMENSIONS: mm	TOLERANCES UNLESS OTHERWISE SPECIFIED:	DWN	TE Connectivity			
0 PLC ± - 1 PLC ± 0.3 2 PLC ± 0.2 3 PLC ± 0.15 4 PLC ± - ANGLES ± 3°	FINISH	CHK	NAME			
MATERIAL		APVD	ATX POWER CONNECTOR 4.2mm PITCH, VERTICAL, DIP TYPE			
		PRODUCT SPEC	SIZE	CAGE CODE	DRAWING NO	RESTRICTED TO
		APPLICATION SPEC	A3	00779	C=1775099	
		WEIGHT	SEE TABLE			
		CUSTOMER DRAWING	SCALE	SHEET	3 OF 7	REV J

THIS DRAWING IS UNPUBLISHED. RELEASED FOR PUBLICATION
 © COPYRIGHT 2010 BY TYCO ELECTRONICS CORPORATION. ALL RIGHTS RESERVED.

LOC		DIST		REVISIONS			
P	LTR	DESCRIPTION		DATE	DWN	APVD	
DW				SEE SHEET 1.			

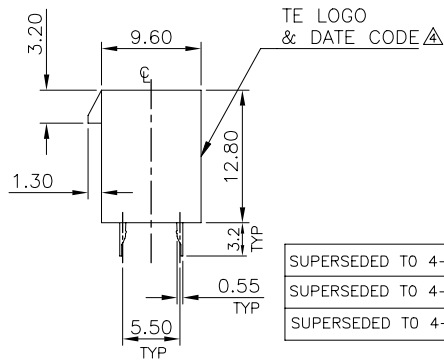
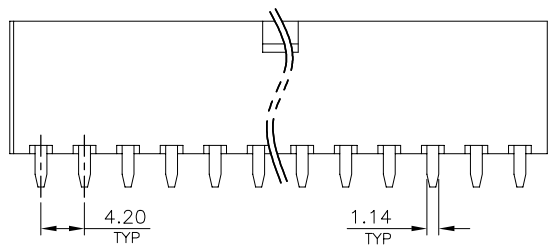
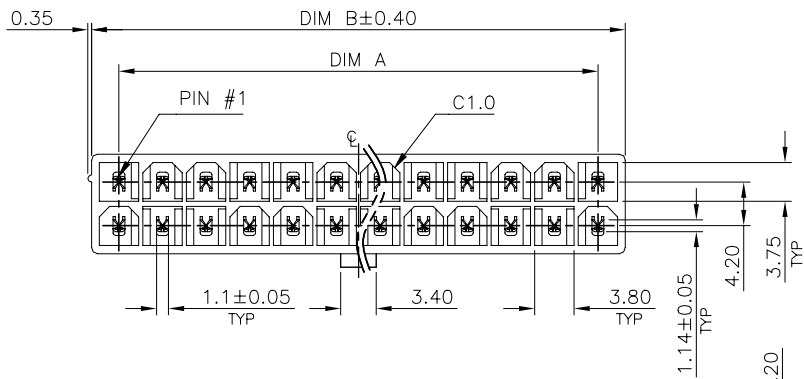

NO BOARDLOCK

- NOTE:
- MATERIAL:
HOUSING: PA9T, UL94 V-0, COLOR: (SEE TABLE).
CONTACTS: BRASS.
 - FINISH:
CONTACTS: 3.05um [120u"] MIN. MATTE-TIN.
1.27um [50u"] MIN. NICKEL UNDERPLATED ALL OVER.
 - WAVE SOLDER CAPABLE TO 265°C PER TEST SPEC.
109-202, CONDITION B.
 - NO TE LOGO AND DATE CODE ON THE PRODUCT WITH 4 POS.
 - THE KEY IDENTIFIED WAS SHOWN ON PAGE 5.
 - PACKING WITH TRAY.

SUPERSEDED TO 4-1775099-3	IVORY PA9T	2.28	16.8	22.1	10	5-1775099-3
SUPERSEDED TO 4-1775099-2		1.89	12.6	17.9	8	5-1775099-2
SUPERSEDED TO 4-1775099-1		1.49	8.4	13.7	6	5-1775099-1
IVORY PA9T	5.37	46.2	51.5	24	4-1775099-8	
	4.27	37.8	43.1	20	4-1775099-7	
	3.87	33.6	38.9	18	4-1775099-6	
	3.08	25.2	30.5	14	4-1775099-5	
	2.68	21.0	26.3	12	4-1775099-4	
	2.28	16.8	22.1	10	4-1775099-3	
	1.89	12.6	17.9	8	4-1775099-2	
	1.49	8.4	13.7	6	4-1775099-1	
	1.10	4.2	9.5	4	4-1775099-0	
	HSG COLOR & MATERIAL	WEIGHT	DIM A	DIM B	POS.	PART NUMBER

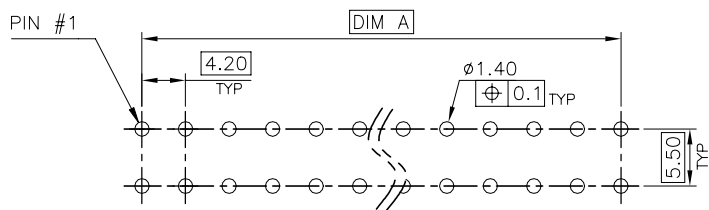

RECOMMENDED PCB LAYOUT
 TOLERANCE: ±0.05 T=1.6mm

THIS DRAWING IS A CONTROLLED DOCUMENT.

DIMENSIONS: mm	TOLERANCES UNLESS OTHERWISE SPECIFIED:	DWN	TE Connectivity		
0 PLC ± - 1 PLC ± 0.3 2 PLC ± 0.2 3 PLC ± 0.15 4 PLC ± - ANGLES ± 3°		CHK	NAME		
MATERIAL	FINISH	APVD	ATX POWER CONNECTOR 4.2mm PITCH, VERTICAL, DIP TYPE		
		PRODUCT SPEC	SIZE	CAGE CODE	DRAWING NO
		APPLICATION SPEC	A3	00779	C=1775099
		WEIGHT	RESTRICTED TO		
		CUSTOMER DRAWING	SCALE	SHEET	REV
				4 OF 7	J

THIS DRAWING IS UNPUBLISHED. RELEASED FOR PUBLICATION
 © COPYRIGHT 2010 BY TYCO ELECTRONICS CORPORATION. ALL RIGHTS RESERVED.

LOC		DIST		REVISIONS			
P	LTR	DESCRIPTION		DATE	DWN	APVD	
DW				SEE SHEET 1.			

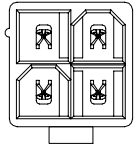

4 POS

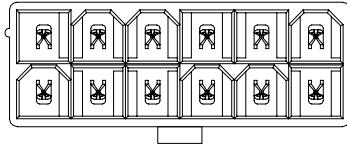

12 POS

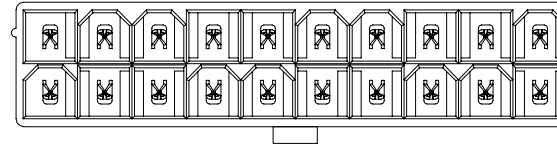

20 POS

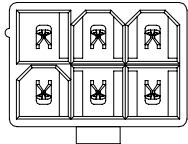

6 POS

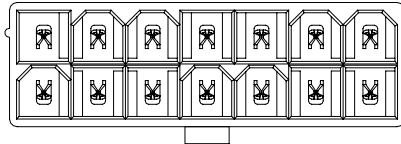

14 POS

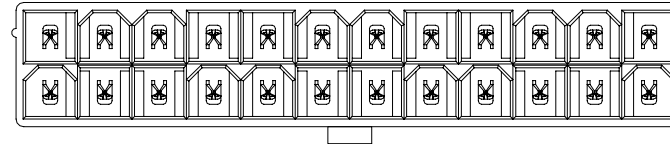

24 POS

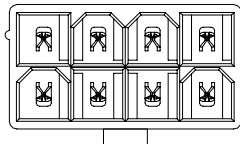

8 POS

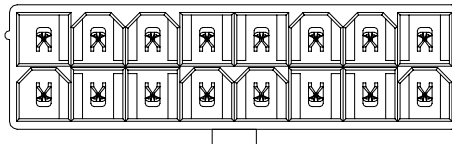

16 POS

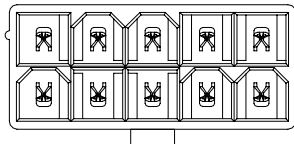

10 POS

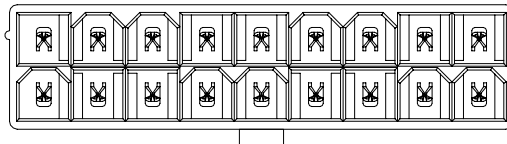

18 POS

KEY POSITION IDENTIFIED
(TOP VIEW)

THIS DRAWING IS A CONTROLLED DOCUMENT.		DWN	TE Connectivity	
DIMENSIONS: mm		CHK	NAME	
TOLERANCES UNLESS OTHERWISE SPECIFIED:		APVD	ATX POWER CONNECTOR 4.2mm PITCH, VERTICAL, DIP TYPE	
0 PLC ± -		PRODUCT SPEC	SIZE	RESTRICTED TO
1 PLC ± 0.3		APPLICATION SPEC	CAGE CODE	
2 PLC ± 0.2		WEIGHT	DRAWING NO	
3 PLC ± 0.15		CUSTOMER DRAWING	A3 00779	
4 PLC ± -		SCALE	C=1775099	
ANGLES ± 3'		SHEET	5 OF 7	REV J

THIS DRAWING IS UNPUBLISHED. RELEASED FOR PUBLICATION
 © COPYRIGHT 2010 BY TYCO ELECTRONICS CORPORATION. ALL RIGHTS RESERVED.

LOC		DIST		REVISIONS			
P	LTR	DESCRIPTION		DATE	DWN	APVD	
		SEE SHEET 1.					

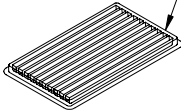
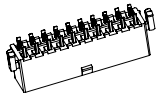
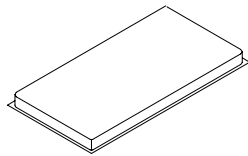

QUANTITY SEE TABLE

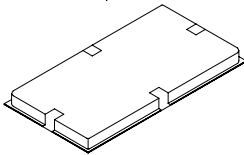

10 TRAY

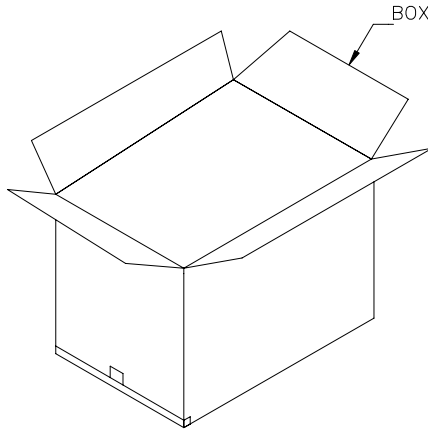
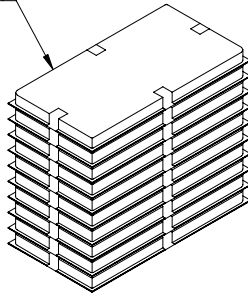

BOX

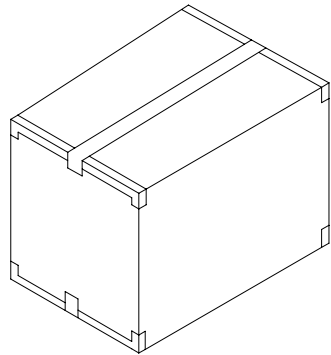

NOTES:

- 1. TRAY : PVC, SIZE: 330mm(L)X 265mm(W)X 22mm(H).
- 2. BOX : CORRUGATED, SIZE: 350mm(L)X 279mm(W)X 195mm(H).
- 3. QUANTITY: SEE TABLE.

GROSS WEIGHT	NET WEIGHT	PCS /TRAY	TRAYS /BOX	PCS /BOX	POS.	NO. OF BOARDLOCK
5.94	4.34	80	10	800	24	2
5.93	4.33	100	10	1000	20	
5.53	3.93	100	10	1000	18	
5.85	4.25	120	10	1200	16	
6.00	4.40	140	10	1400	14	
5.98	4.38	160	10	1600	12	
5.81	4.21	180	10	1800	10	
5.89	4.29	220	10	2200	8	
5.94	4.34	280	10	2800	6	
5.78	4.18	360	10	3600	4	
5.92	4.32	80	10	800	24	1
5.90	4.30	100	10	1000	20	
6.28	4.68	120	10	1200	18	
5.95	4.35	140	10	1400	14	
5.94	4.34	160	10	1600	12	
6.22	4.62	200	10	2000	10	
6.21	4.61	240	10	2400	8	
6.16	4.56	300	10	3000	6	
6.35	4.75	420	10	4200	4	
5.90	4.30	80	10	800	24	
5.87	4.27	100	10	1000	20	
6.24	4.64	120	10	1200	18	
5.91	4.31	140	10	1400	14	
6.42	4.82	180	10	1800	12	
6.16	4.56	200	10	2000	10	
6.51	4.91	260	10	2600	8	
6.67	5.07	340	10	3400	6	
6.88	5.28	480	10	4800	4	

THIS DRAWING IS A CONTROLLED DOCUMENT.

DIMENSIONS: mm		TOLERANCES UNLESS OTHERWISE SPECIFIED:	
		0 PLC	± -
		1 PLC	± 0.3
		2 PLC	± 0.2
		3 PLC	± 0.15
		4 PLC	± -
		ANGLES	± 3'
MATERIAL	FINISH		

DWN	-
CHK	-
APVD	-
PRODUCT SPEC	-
APPLICATION SPEC	-
WEIGHT	-
CUSTOMER DRAWING	-

STE TE Connectivity

ATX POWER CONNECTOR
4.2mm PITCH, VERTICAL, DIP TYPE

SIZE	CAGE CODE	DRAWING NO	RESTRICTED TO
A3	00779	C=1775099	

SCALE: - SHEET: 6 OF 7 REV: J

THIS DRAWING IS UNPUBLISHED. RELEASED FOR PUBLICATION
 © COPYRIGHT 2010 BY TYCO ELECTRONICS CORPORATION. ALL RIGHTS RESERVED.

LOC	DIST	REVISIONS					
DW		P	LTR	DESCRIPTION	DATE	DWN	APVD
				SEE SHEET 1.			

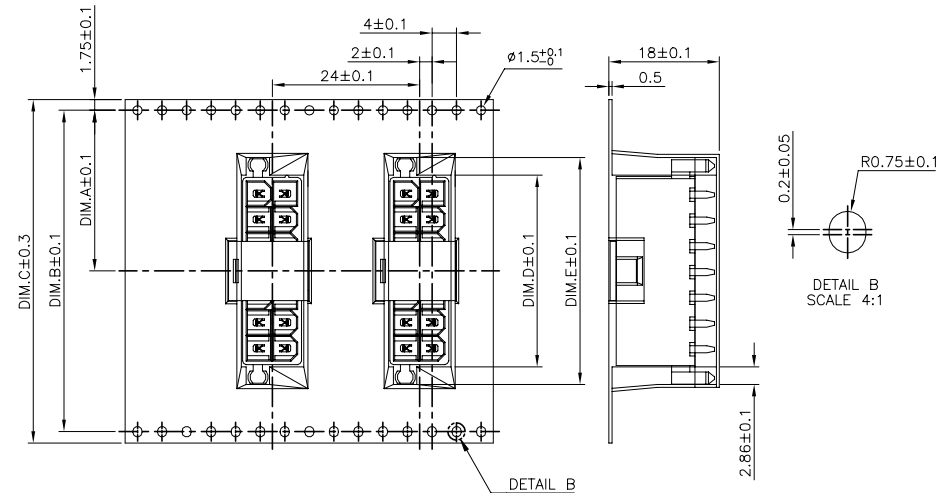
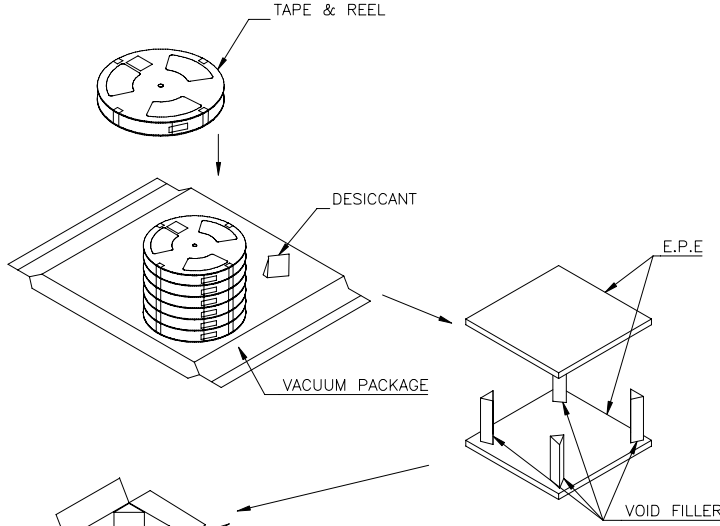
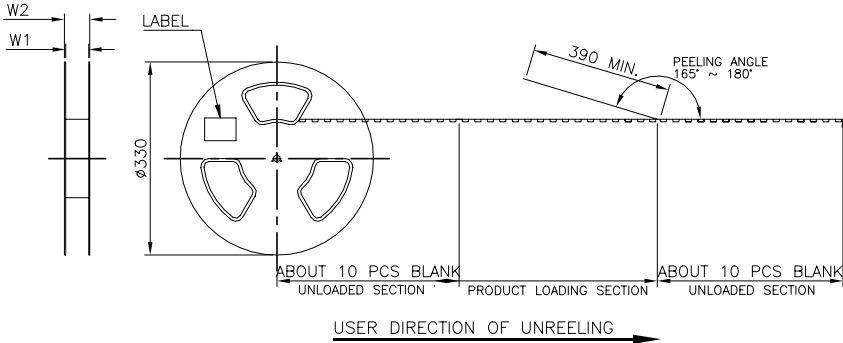

- NOTES:
- MATERIAL:
 BOX: FIBREBOARD, CORRUGATED, DOUBLE WALL.
 COVER TAPE: PET, TRANSPARENT COLOR.
 CARRIER TAPE: POLYSTYRENES, BLACK COLOR.
 REEL: POLYSTYRENES, BLUE COLOR.
 BAG: POLYETHYLENE.
 - PEELING STRENGTH: 0.1 ~ 1.3 N (10 ~ 130 GRAMS)
 - PEELING SPEED: 300 mm/min.
 - EACH BAG SHALL BE INCLUDED DESICCANT.

60.4	56.4	37.0	31.28	56.0	52.4	26.2	5.7 KG	2.40 KG	140	5	700	14	6-1775099-9
W2	W1	DIM. E	DIM. D	DIM. C	DIM. B	DIM. A	GROSS WEIGHT	NET WEIGHT	PCS/ REEL	REEL/ BOX	PCS/ BOX	POS.	PART NUMBER

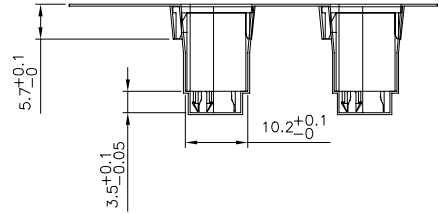

THIS DRAWING IS A CONTROLLED DOCUMENT.

DIMENSIONS: mm	TOLERANCES UNLESS OTHERWISE SPECIFIED: 0 PLC ± - 1 PLC ± 0.3 2 PLC ± 0.2 3 PLC ± 0.15 4 PLC ± - ANGLES ± 3'	DWN CHK APVD PRODUCT SPEC APPLICATION SPEC WEIGHT CUSTOMER DRAWING	NAME ATX POWER CONNECTOR 4.2mm PITCH, VERTICAL, DIP TYPE
MATERIAL	FINISH	SIZE A3	CAGE CODE 00779
		DRAWING NO C=1775099	RESTRICTED TO
		SCALE	SHEET 7 OF 7
		REV	J