

Data sheet | Item number: 2002-2971

Double-deck disconnect terminal block; with pivoting knife disconnect; same profile as double-deck, double-disconnect terminal block; L/L; for DIN-rail 35 x 15 and 35 x 7.5; 2.5 mm²; Push-in CAGE CLAMP®; 2,50 mm²; gray

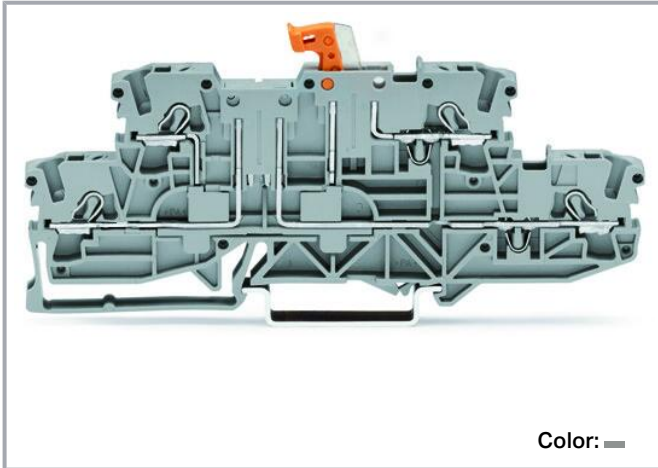

www.wago.com/2002-2971



Color: —

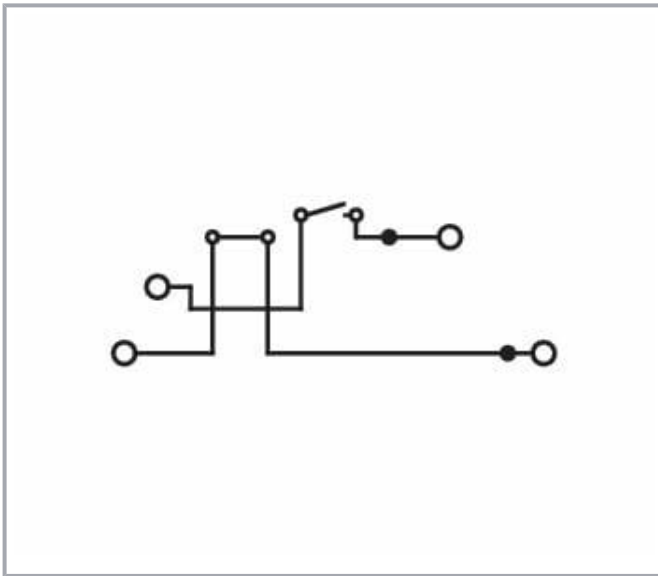
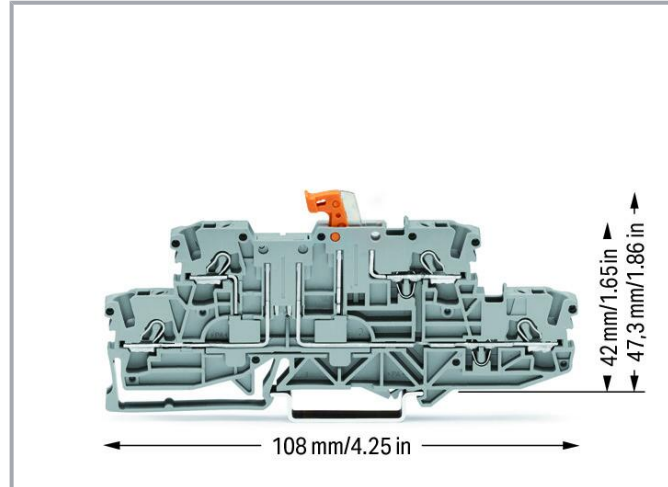

Data

Electrical data

Ratings per IEC/EN

Ratings per	IEC/EN 60947-7-1
Nominal voltage (III/3)	400 V

Subject to changes. Please also observe the further product documentation!

WAGO GmbH & Co. KG
Hansastr. 27
32423 Minden
Phone: +49571 887-0 | Fax: +49571 887-169
Email: info.de@wago.com | Web: www.wago.com

Do you have any questions about our products?
We are always happy to take your call at +49 (571) 887-44222.



Rated impulse voltage (III/3)	6 kV
Rated current	16 A
Legend (ratings)	(III / 3) $\hat{=}$ Overvoltage category III / Pollution degree 3

Ratings per UL 1059

Approvals per	UL 1059
Rated voltage UL (Use Group B)	300 V
Rated current UL (Use Group B)	15 A
Rated voltage UL (Use Group C)	300 V
Rated current UL (Use Group C)	15 A

Ratings per CSA

Approvals per	CSA 22.2 No 158
Rated voltage CSA (Use Group B)	300 V
Rated current CSA (Use Group B)	15 A
Rated voltage CSA (Use Group C)	150 V
Rated current CSA (Use Group C)	15 A
Rated voltage CSA (Use Group D)	300 V
Rated current CSA (Use Group D)	15 A

Ex information

Ratings per	ATEX: KIWA 17 ATEX 0030 U / IECEx: KIWA 17.0014U (Ex ec IIC Gc)
Rated voltage EN (Ex e II)	440 V
Rated current (Ex e II)	14 A

Power loss

Power loss, per pole (potential)	0.341 W
Rated current I_N for specified power loss	16 A
Resistance value for specified, current-dependent power loss	0.001 Ω

Connection data

Connection points	4
Total number of potentials	4
Number of levels	2
Number of jumper slots	2

Subject to changes. Please also observe the further product documentation!



Connection 1

Connection technology	Push-in CAGE CLAMP®
Actuation type	Operating tool
Connectable conductor materials	Copper
Nominal cross-section	2.5 mm ²
Solid conductor	0.25 ... 4 mm ² / 22 ... 12 AWG
Solid conductor; push-in termination	0.75 ... 4 mm ² / 18 ... 12 AWG
Fine-stranded conductor	0.25 ... 4 mm ² / 22 ... 12 AWG
Fine-stranded conductor; with insulated ferrule	0.25 ... 2.5 mm ² / 22 ... 14 AWG
Fine-stranded conductor; with ferrule; push-in termination	1 ... 2.5 mm ² / 18 ... 14 AWG
Note (conductor cross-section)	Depending on the conductor characteristic, a conductor with a smaller cross-section can also be inserted via push-in termination.
Strip length	10 ... 12 mm / 0.39 ... 0.47 inches
Wiring direction	Front-entry wiring

Physical data

Width	5.2 mm / 0.205 inches
Height	108 mm / 4.252 inches
Depth from upper-edge of DIN-rail	42 mm / 1.654 inches

Mechanical Data

Potential marking	L/L
Mounting type	DIN-35 rail
Marking level	Side marking

Material Data

Note (material data)	Information on material specifications can be found here
Color	gray
Material group	I
Insulation material	Polyamide (PA66)
Flammability class per UL94	V0
Fire load	0.311 MJ
Weight	17.4 g

Subject to changes. Please also observe the further product documentation!

Environmental requirements

Processing temperature	-35 ... +85 °C
Continuous operating temperature	-60 ... +105 °C

Commercial data





Product Group	22 (TOPJOB S)
eCl@ss 10.0	27-14-11-26
eCl@ss 9.0	27-14-11-26
ETIM 8.0	EC000902
ETIM 7.0	EC000902
PU (SPU)	50 pcs
Packaging type	box
Country of origin	CN
GTIN	4050821006817
Customs tariff number	85365080900

Environmental Product Compliance

RoHS Compliance Status	Compliant, No Exemption
------------------------	-------------------------

Approvals / Certificates

General approvals

Logo	Approval	Additional Approval Text	Certificate name
	CCA DEKRA Certification B.V.	EN 60947	71-120369
	CCA DEKRA Certification B.V.	EN 60947	NTR NL 7892
	CCC CNEX	GB/T 3836.3	2020312313000180 (Ex ec IIC Gc)
	CSA DEKRA Certification B.V.	C22.2 No. 158	1536069



Subject to changes. Please also observe the further product documentation!

	UL Underwriters Laboratories Inc.	UL 1059	E45172
--	--------------------------------------	---------	--------

Declarations of conformity and manufacturer's declarations

Logo	Approval	Additional Approval Text	Certificate name
	Railway WAGO GmbH & Co. KG	-	Railway Ready

Approvals for marine applications

Logo	Approval	Additional Approval Text	Certificate name
	ABS American Bureau of Shipping	EN 60947	20- HG1941090- PDA
	DNV GL Det Norske Veritas, Germanischer Lloyd	-	TAE00001V2

Approvals for hazardous areas

Logo	Approval	Additional Approval Text	Certificate name
	AEx Underwriters Laboratories Inc.	UL 60079	E185892 (AEx eb IIC resp. Ex eb IIC)
	ATEX KIWA Netherlands B.V.	EN 60079	KIWA 17ATEX0030 U
	CCC CNEX	GB/T 3836.3	2020312313000180 (Ex ec IIC Gc)
	IECEX KIWA Netherlands B.V.	EN 60079	IECEX KIWA 17.0014 U (Ex ec IIC Gc)

Subject to changes. Please also observe the further product documentation!

WAGO GmbH & Co. KG
Hansastr. 27
32423 Minden
Phone: +49571 887-0 | Fax: +49571 887-169
Email: info.de@wago.com | Web: www.wago.com

Do you have any questions about our products?
We are always happy to take your call at +49 (571) 887-44222.

Required accessories

End plate

End plate



Item no.: 2002-2991

End and intermediate plate; 1 mm thick; gray

www.wago.com/2002-2991



Item no.: 2002-2992

End and intermediate plate; 1 mm thick; orange

www.wago.com/2002-2992

Optional accessories

Insulation stop

Insulation stop



Item no.: 2002-171

Insulation stop; 0.25 - 0.5 mm²; 5 pieces/strip; light gray

www.wago.com/2002-171



Item no.: 2002-172

Insulation stop; 0.75 - 1 mm²; 5 pieces/strip; dark gray

www.wago.com/2002-172

Tool

Operating tool



Item no.: 210-658

Operating tool; Blade: 3.5 x 0.5 mm; with a partially insulated shaft; angled; short; multicoloured

www.wago.com/210-658



Item no.: 210-720

Operating tool; Blade: 3.5 x 0.5 mm; with a partially insulated shaft; multicoloured

www.wago.com/210-720

Protective warning marker

Cover



Item no.: 2002-115

Protective warning marker; for 5 terminal blocks; with high-voltage symbol, black; yellow

www.wago.com/2002-115

Testing and measuring

Testing accessories



Item no.: 2009-174

Test plug adapter; for 4 mm Ø test plugs; for testing TOPJOB®S rail-mounted terminal blocks; gray

www.wago.com/2009-174

Subject to changes. Please also observe the further product documentation!

WAGO GmbH & Co. KG

Hansastr. 27

32423 Minden

Phone: +49571 887-0 | Fax: +49571 887-169

Email: info.de@wago.com | Web: www.wago.com

Do you have any questions about our products?

We are always happy to take your call at +49 (571) 887-44222.



Item no.: 2009-182

Testing tap; for max. 2.5 mm²; tool-free connection for individual test wires 0.08 - 2.5 mm; gray

www.wago.com/2009-182



Item no.: 2002-511

Modular TOPJOB®S connector; modular; for jumper contact slot; 1-pole; 2,50 mm²; gray

www.wago.com/2002-511



Item no.: 2002-549

Spacer module; modular; e.g., for bridging commoned terminal blocks; gray

www.wago.com/2002-549



Item no.: 2002-552

Modular TOPJOB®S connector; modular; for jumper contact slot; 2-pole; 2,50 mm²; gray

www.wago.com/2002-552



Item no.: 2002-558

Modular TOPJOB®S connector; modular; for jumper contact slot; 8-pole; 2,50 mm²; gray

www.wago.com/2002-558



Item no.: 2002-559

Modular TOPJOB®S connector; modular; for jumper contact slot; 9-pole; 2,50 mm²; gray

www.wago.com/2002-559



Item no.: 2002-556

Modular TOPJOB®S connector; modular; for jumper contact slot; 6-pole; 2,50 mm²; gray

www.wago.com/2002-556



Item no.: 2002-553

Modular TOPJOB®S connector; modular; for jumper contact slot; 3-pole; 2,50 mm²; gray

www.wago.com/2002-553



Item no.: 2002-611

TOPJOB®S L-type test plug module; modular; 1-pole; 2,50 mm²; gray

www.wago.com/2002-611



Item no.: 2002-560

Modular TOPJOB®S connector; modular; for jumper contact slot; 10-pole; 2,50 mm²; gray

www.wago.com/2002-560



Item no.: 2002-554

Modular TOPJOB®S connector; modular; for jumper contact slot; 4-pole; 2,50 mm²; gray

www.wago.com/2002-554



Item no.: 2002-555

Modular TOPJOB®S connector; modular; for jumper contact slot; 5-pole; 2,50 mm²; gray

www.wago.com/2002-555



Item no.: 2002-557

Modular TOPJOB®S connector; modular; for jumper contact slot; 7-pole; 2,50 mm²; gray

www.wago.com/2002-557



Item no.: 2002-649

TOPJOB®S L-type spacer module; modular; e.g., for bridging commoned terminal blocks; gray

www.wago.com/2002-649



Item no.: 210-136

Test plug; 2 mm Ø; with 500 mm cable; red

www.wago.com/210-136

End plate

End plate



Item no.: 209-192

Separator for Ex e/Ex i applications; 3 mm thick; 125.5 mm wide; orange

www.wago.com/209-192

Subject to changes. Please also observe the further product documentation!

WAGO GmbH & Co. KG

Hansastr. 27

32423 Minden













Phone: +49571 887-0 | Fax: +49571 887-169

Email: info.de@wago.com | Web: www.wago.com













Do you have any questions about our products?

We are always happy to take your call at +49 (571) 887-44222.

Marking accessories

Marking strip		
	Item no.: 2009-110 Marking strips; for Smart Printer; on reel; not stretchable; plain; snap-on type; white	www.wago.com/2009-110
Marker carrier		
	Item no.: 2009-198 Adaptor; gray	www.wago.com/2009-198
	Item no.: 2002-160 Adaptor; gray	www.wago.com/2002-160
Marker		
	Item no.: 2009-115/000-002 WMB-Inline; for Smart Printer; 1500 pieces on roll; stretchable 5 - 5.2 mm; plain; snap-on type; yellow	www.wago.com/2009-115/000-002
	Item no.: 2009-115/000-007 WMB-Inline; for Smart Printer; 1500 pieces on roll; stretchable 5 - 5.2 mm; plain; snap-on type; gray	www.wago.com/2009-115/000-007
	Item no.: 2009-115/000-017 WMB-Inline; for Smart Printer; 1500 pieces on roll; stretchable 5 - 5.2 mm; plain; snap-on type; light green	www.wago.com/2009-115/000-017
	Item no.: 2009-115/000-023 WMB-Inline; for Smart Printer; 1500 pieces on roll; stretchable 5 - 5.2 mm; plain; snap-on type; green	www.wago.com/2009-115/000-023
	Item no.: 2009-115/000-024 WMB-Inline; for Smart Printer; 1500 pieces on roll; stretchable 5 - 5.2 mm; plain; snap-on type; violet	www.wago.com/2009-115/000-024
	Item no.: 2009-145/000-006 Mini-WSB Inline; for Smart Printer; 1700 pieces on roll; stretchable 5 - 5.2 mm; plain; snap-on type; blue	www.wago.com/2009-145/000-006
	Item no.: 2009-145 Mini-WSB Inline; for Smart Printer; 1700 pieces on roll; stretchable 5 - 5.2 mm; plain; snap-on type; white	www.wago.com/2009-145
	Item no.: 2009-145/000-002 Mini-WSB Inline; for Smart Printer; 1700 pieces on roll; stretchable 5 - 5.2 mm; plain; snap-on type; yellow	www.wago.com/2009-145/000-002
	Item no.: 2009-145/000-007 Mini-WSB Inline; for Smart Printer; 1700 pieces on roll; stretchable 5 - 5.2 mm; plain; snap-on type; gray	www.wago.com/2009-145/000-007

Subject to changes. Please also observe the further product documentation!

	Item no.: 2009-145/000-005 Mini-WSB Inline; for Smart Printer; 1700 pieces on roll; stretchable 5 - 5.2 mm; plain; snap-on type; red	www.wago.com/2009-145/000-005
	Item no.: 2009-145/000-012 Mini-WSB Inline; for Smart Printer; 1700 pieces on roll; stretchable 5 - 5.2 mm; plain; snap-on type; orange	www.wago.com/2009-145/000-012
	Item no.: 2009-145/000-023 Mini-WSB Inline; for Smart Printer; 1700 pieces on roll; stretchable 5 - 5.2 mm; plain; snap-on type; green	www.wago.com/2009-145/000-023
	Item no.: 2009-145/000-024 Mini-WSB Inline; for Smart Printer; 1700 pieces on roll; stretchable 5 - 5.2 mm; plain; snap-on type; violet	www.wago.com/2009-145/000-024
	Item no.: 2009-115 WMB-Inline; for Smart Printer; 1500 pieces on roll; stretchable 5 - 5.2 mm; plain; snap-on type; white	www.wago.com/2009-115
	Item no.: 248-501/000-006 Mini-WSB marking card; as card; not stretchable; plain; snap-on type; blue	www.wago.com/248-501/000-006
	Item no.: 248-501/000-007 Mini-WSB marking card; as card; not stretchable; plain; snap-on type; gray	www.wago.com/248-501/000-007
	Item no.: 248-501/000-002 Mini-WSB marking card; as card; not stretchable; plain; snap-on type; yellow	www.wago.com/248-501/000-002
	Item no.: 248-501/000-012 Mini-WSB marking card; as card; not stretchable; plain; snap-on type; orange	www.wago.com/248-501/000-012
	Item no.: 248-501 Mini-WSB marking card; as card; not stretchable; plain; snap-on type; white	www.wago.com/248-501
	Item no.: 248-501/000-017 Mini-WSB marking card; as card; not stretchable; plain; snap-on type; light green	www.wago.com/248-501/000-017
	Item no.: 248-501/000-005 Mini-WSB marking card; as card; not stretchable; plain; snap-on type; red	www.wago.com/248-501/000-005

Subject to changes. Please also observe the further product documentation!



Item no.: 248-501/000-024

Mini-WSB marking card; as card; not stretchable; plain; snap-on type; violet

www.wago.com/248-501/000-024



Item no.: 248-501/000-023

Mini-WSB marking card; as card; not stretchable; plain; snap-on type; green

www.wago.com/248-501/000-023



Item no.: 793-5501/000-007

WMB marking card; as card; for terminal block width 5 - 17.5 mm; stretchable 5 - 5.2 mm; plain; snap-on type; gray

www.wago.com/793-5501/000-007



Item no.: 793-5501/000-012

WMB marking card; as card; for terminal block width 5 - 17.5 mm; stretchable 5 - 5.2 mm; plain; snap-on type; orange

www.wago.com/793-5501/000-012



Item no.: 793-5501/000-014

WMB marking card; as card; for terminal block width 5 - 17.5 mm; stretchable 5 - 5.2 mm; plain; snap-on type; brown

www.wago.com/793-5501/000-014



Item no.: 793-5501/000-017

WMB marking card; as card; for terminal block width 5 - 17.5 mm; stretchable 5 - 5.2 mm; plain; snap-on type; light green

www.wago.com/793-5501/000-017



Item no.: 793-5501/000-023

WMB marking card; as card; for terminal block width 5 - 17.5 mm; stretchable 5 - 5.2 mm; plain; snap-on type; green

www.wago.com/793-5501/000-023



Item no.: 793-5501/000-024

WMB marking card; as card; for terminal block width 5 - 17.5 mm; stretchable 5 - 5.2 mm; plain; snap-on type; violet

www.wago.com/793-5501/000-024



Item no.: 793-5501/000-005

WMB marking card; as card; for terminal block width 5 - 17.5 mm; stretchable 5 - 5.2 mm; plain; snap-on type; red

www.wago.com/793-5501/000-005



Item no.: 793-5501/000-002

WMB marking card; as card; for terminal block width 5 - 17.5 mm; stretchable 5 - 5.2 mm; plain; snap-on type; yellow

www.wago.com/793-5501/000-002















Item no.: 793-5501/000-006







WMB marking card; as card; for terminal block width 5 - 17.5 mm; stretchable 5 - 5.2 mm; plain; snap-on type; blue

www.wago.com/793-5501/000-006

Subject to changes. Please also observe the further product documentation!

	Item no.: 793-5501 WMB marking card; as card; for terminal block width 5 - 17.5 mm; stretchable 5 - 5.2 mm; plain; snap-on type; white	www.wago.com/793-5501
	Item no.: 2009-115/000-012 WMB-Inline; for Smart Printer; 1500 pieces on roll; stretchable 5 - 5.2 mm; plain; snap-on type; orange	www.wago.com/2009-115/000-012
	Item no.: 2009-115/000-006 WMB-Inline; for Smart Printer; 1500 pieces on roll; stretchable 5 - 5.2 mm; plain; snap-on type; blue	www.wago.com/2009-115/000-006
	Item no.: 2009-115/000-005 WMB-Inline; for Smart Printer; 1500 pieces on roll; stretchable 5 - 5.2 mm; plain; snap-on type; red	www.wago.com/2009-115/000-005
Group marker carrier		
	Item no.: 2009-193 Group marker carrier; gray	www.wago.com/2009-193
	Item no.: 2009-192 Group marker carrier; gray	www.wago.com/2009-192
	Item no.: 2009-191 Group marker carrier; gray	www.wago.com/2009-191
Mounting		
Cover carrier		
	Item no.: 709-169 Cover carrier; Type 3; gray	www.wago.com/709-169
Cover		
	Item no.: 709-156 Cover; Type 3; suitable for cover carrier, type 3; 1 m long; transparent	www.wago.com/709-156
Carrier rail		
Mounting accessories		
	Item no.: 210-197 Steel carrier rail; 35 x 15 mm; 1.5 mm thick; 2 m long; slotted; similar to EN 60715; silver-colored	www.wago.com/210-197
	Item no.: 210-198 Copper carrier rail; 35 x 15 mm; 2.3 mm thick; 2 m long; unslotted; according to EN 60715; copper-colored	www.wago.com/210-198
	Item no.: 210-504 Steel carrier rail; 35 x 7.5 mm; 1 mm thick; 2 m long; slotted; galvanized; according to EN 60715; silver-colored	www.wago.com/210-504
	Item no.: 210-505 Steel carrier rail; 35 x 7.5 mm; 1 mm thick; 2 m long; unslotted; galvanized; according to EN 60715; silver-colored	www.wago.com/210-505



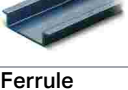









Subject to changes. Please also observe the further product documentation!

	Item no.: 210-506 Steel carrier rail; 35 x 15 mm; 1.5 mm thick; 2 m long; unslotted; galvanized; similar to EN 60715; silver-colored	www.wago.com/210-506
	Item no.: 210-508 Steel carrier rail; 35 x 15 mm; 1.5 mm thick; 2 m long; slotted; galvanized; similar to EN 60715; silver-colored	www.wago.com/210-508
	Item no.: 210-113 Steel carrier rail; 35 x 7.5 mm; 1 mm thick; 2 m long; unslotted; according to EN 60715; silver-colored	www.wago.com/210-113
	Item no.: 210-118 Steel carrier rail; 35 x 15 mm; 2.3 mm thick; 2 m long; unslotted; according to EN 60715; silver-colored	www.wago.com/210-118
	Item no.: 210-112 Steel carrier rail; 35 x 7.5 mm; 1 mm thick; 2 m long; slotted; according to EN 60715; "Hole width 25 mm; silver-colored	www.wago.com/210-112
	Item no.: 210-114 Steel carrier rail; 35 x 15 mm; 1.5 mm thick; 2 m long; unslotted; similar to EN 60715; silver-colored	www.wago.com/210-114
	Item no.: 210-115 Steel carrier rail; 35 x 7.5 mm; 1 mm thick; 2 m long; slotted; according to EN 60715; "Hole width 18 mm; silver-colored	www.wago.com/210-115
	Item no.: 210-196 Aluminum carrier rail; 35 x 8.2 mm; 1.6 mm thick; 2 m long; unslotted; similar to EN 60715; silver-colored	www.wago.com/210-196

Ferrule

Ferrule		
	Item no.: 216-241 Ferrule; Sleeve for 0.5 mm ² / 20 AWG; insulated; electro-tin plated; electrolytic copper; gastight crimped; acc. to DIN 46228, Part 4/09.90; white	www.wago.com/216-241
	Item no.: 216-242 Ferrule; Sleeve for 0.75 mm ² / 18 AWG; insulated; electro-tin plated; electrolytic copper; gastight crimped; acc. to DIN 46228, Part 4/09.90; gray	www.wago.com/216-242
	Item no.: 216-243 Ferrule; Sleeve for 1 mm ² / AWG 18; insulated; electro-tin plated; electrolytic copper; gastight crimped; acc. to DIN 46228, Part 4/09.90; red	www.wago.com/216-243
	Item no.: 216-244 Ferrule; Sleeve for 1.5 mm ² / AWG 16; insulated; electro-tin plated; electrolytic copper; gastight crimped; acc. to DIN 46228, Part 4/09.90; black	www.wago.com/216-244
	Item no.: 216-263 Ferrule; Sleeve for 1 mm ² / AWG 18; insulated; electro-tin plated; electrolytic copper; gastight crimped; acc. to DIN 46228, Part 4/09.90; red	www.wago.com/216-263
	Item no.: 216-246 Ferrule; Sleeve for 2.5 mm ² / AWG 14; insulated; electro-tin plated; electrolytic copper; gastight crimped; acc. to DIN 46228, Part 4/09.90; blue	www.wago.com/216-246
	Item no.: 216-266 Ferrule; Sleeve for 2.5 mm ² / AWG 14; insulated; electro-tin plated; electrolytic copper; gastight crimped; acc. to DIN 46228, Part 4/09.90; blue	www.wago.com/216-266

Subject to changes. Please also observe the further product documentation!

	Item no.: 216-264 Ferrule; Sleeve for 1.5 mm ² / AWG 16; insulated; electro-tin plated; electrolytic copper; gastight crimped; acc. to DIN 46228, Part 4/09.90; black	www.wago.com/216-264
	Item no.: 216-262 Ferrule; Sleeve for 0.75 mm ² / 18 AWG; insulated; electro-tin plated; electrolytic copper; gastight crimped; acc. to DIN 46228, Part 4/09.90; gray	www.wago.com/216-262
Jumpers		
Jumper		
	Item no.: 210-123 Wire commoning chain; insulated; blue	www.wago.com/210-123
	Item no.: 2002-402 Jumper; 2-way; insulated; light gray	www.wago.com/2002-402
	Item no.: 2002-402/000-005 Jumper; 2-way; insulated; red	www.wago.com/2002-402/000-005
	Item no.: 2002-400 Continuous jumper; 2-way; insulated; light gray	www.wago.com/2002-400
	Item no.: 2002-403 Jumper; 3-way; insulated; light gray	www.wago.com/2002-403
	Item no.: 2002-404/000-005 Jumper; 4-way; insulated; red	www.wago.com/2002-404/000-005
	Item no.: 2002-403/000-006 Jumper; 3-way; insulated; blue	www.wago.com/2002-403/000-006
	Item no.: 2002-404/000-006 Jumper; 4-way; insulated; blue	www.wago.com/2002-404/000-006
	Item no.: 2002-403/000-005 Jumper; 3-way; insulated; red	www.wago.com/2002-403/000-005
	Item no.: 2002-405/000-005 Jumper; 5-way; insulated; red	www.wago.com/2002-405/000-005
	Item no.: 2002-402/000-006 Jumper; 2-way; insulated; blue	www.wago.com/2002-402/000-006

Subject to changes. Please also observe the further product documentation!



Item no.: 2002-405/000-006
Jumper; 5-way; insulated; blue

www.wago.com/2002-405/000-006



Item no.: 2002-404
Jumper; 4-way; insulated; light gray

www.wago.com/2002-404



Item no.: 2002-406/000-006
Jumper; 6-way; insulated; blue

www.wago.com/2002-406/000-006



Item no.: 2002-406/000-005
Jumper; 6-way; insulated; red

www.wago.com/2002-406/000-005



Item no.: 2002-406/020-000
Delta jumper; insulated; light gray

www.wago.com/2002-406/020-000



Item no.: 2002-405
Jumper; 5-way; insulated; light gray

www.wago.com/2002-405



Item no.: 2002-407/000-005
Jumper; 7-way; insulated; red

www.wago.com/2002-407/000-005



Item no.: 2002-408
Jumper; 8-way; insulated; light gray

www.wago.com/2002-408



Item no.: 2002-408/000-006
Jumper; 8-way; insulated; blue

www.wago.com/2002-408/000-006



Item no.: 2002-405/011-000
Star point jumper; 3-way; insulated; light gray

www.wago.com/2002-405/011-000



Item no.: 2002-407/000-006
Jumper; 7-way; insulated; blue















www.wago.com/2002-407/000-006



















Item no.: 2002-408/000-005
Jumper; 8-way; insulated; red

www.wago.com/2002-408/000-005













Subject to changes. Please also observe the further product documentation!

	Item no.: 2002-407 Jumper; 7-way; insulated; light gray	www.wago.com/2002-407
	Item no.: 2002-406 Jumper; 6-way; insulated; light gray	www.wago.com/2002-406
	Item no.: 2002-410/000-005 Jumper; 10-way; insulated; red	www.wago.com/2002-410/000-005
	Item no.: 2002-410/000-006 Jumper; 10-way; insulated; blue	www.wago.com/2002-410/000-006
	Item no.: 2002-410 Jumper; 10-way; insulated; light gray	www.wago.com/2002-410
	Item no.: 2002-409/000-006 Jumper; 9-way; insulated; blue	www.wago.com/2002-409/000-006
	Item no.: 2002-409/000-005 Jumper; 9-way; insulated; red	www.wago.com/2002-409/000-005
	Item no.: 2002-409 Jumper; 9-way; insulated; light gray	www.wago.com/2002-409
	Item no.: 2002-423/000-006 Continuous jumper; from 1 to 3; insulated; blue	www.wago.com/2002-423/000-006
	Item no.: 2002-423 Continuous jumper; from 1 to 3; insulated; light gray	www.wago.com/2002-423
	Item no.: 2002-433 Jumper; from 1 to 3; insulated; light gray	www.wago.com/2002-433
	Item no.: 2002-434 Jumper; from 1 to 4; insulated; light gray	www.wago.com/2002-434
	Item no.: 2002-423/000-005 Continuous jumper; from 1 to 3; insulated; red	www.wago.com/2002-423/000-005
	Item no.: 2002-435	www.wago.com/2002-435

Subject to changes. Please also observe the further product documentation!

	Jumper; from 1 to 5; insulated; light gray	
	Item no.: 2002-436 Jumper; from 1 to 6; insulated; light gray	www.wago.com/2002-436
	Item no.: 2002-437 Jumper; from 1 to 7; insulated; light gray	www.wago.com/2002-437
	Item no.: 2002-438 Jumper; from 1 to 8; insulated; light gray	www.wago.com/2002-438
	Item no.: 2002-439 Jumper; from 1 to 9; insulated; light gray	www.wago.com/2002-439
	Item no.: 2002-440 Jumper; from 1 to 10; insulated; light gray	www.wago.com/2002-440
	Item no.: 2002-472 Staggered jumper; 2-way; insulated; light gray	www.wago.com/2002-472
	Item no.: 2002-473 Staggered jumper; 3-way; insulated; light gray	www.wago.com/2002-473
	Item no.: 2002-475/011-000 Staggered jumper; 3-way; insulated; light gray	www.wago.com/2002-475/011-000
	Item no.: 2002-475 Staggered jumper; 5-way; insulated; light gray	www.wago.com/2002-475
	Item no.: 2002-476 Staggered jumper; 6-way; insulated; light gray	www.wago.com/2002-476
	Item no.: 2002-474 Staggered jumper; 4-way; insulated; light gray	www.wago.com/2002-474
	Item no.: 2002-477 Staggered jumper; 7-way; insulated; light gray	www.wago.com/2002-477
	Item no.: 2002-473/011-000 Staggered jumper; 2-way; from 1 to 3; insulated; light gray	www.wago.com/2002-473/011-000
	Item no.: 2002-479 Staggered jumper; 9-way; insulated; light gray	www.wago.com/2002-479
	Item no.: 2002-478 Staggered jumper; 8-way; insulated; light gray	www.wago.com/2002-478
	Item no.: 2002-479/011-000 Staggered jumper; insulated; light gray	www.wago.com/2002-479/011-000

Subject to changes. Please also observe the further product documentation!

	Item no.: 2002-480 Staggered jumper; 10-way; insulated; light gray	www.wago.com/2002-480
	Item no.: 2002-477/011-000 Staggered jumper; insulated; light gray	www.wago.com/2002-477/011-000
	Item no.: 2002-481/011-000 Staggered jumper; insulated; light gray	www.wago.com/2002-481/011-000
	Item no.: 2002-481 Staggered jumper; 11-way; insulated; light gray	www.wago.com/2002-481
	Item no.: 2002-482 Staggered jumper; 12-way; insulated; light gray	www.wago.com/2002-482
	Item no.: 210-103 Wire commoning chain; insulated; black	www.wago.com/210-103
	Item no.: 2002-424/000-006 Continuous jumper; from 1 to 4; insulated; blue	www.wago.com/2002-424/000-006
Push-in type wire jumper		
Jumper		
	Item no.: 2009-412 Push-in type wire jumper; insulated; 60 mm long; black	www.wago.com/2009-412
	Item no.: 2009-414 Push-in type wire jumper; 1.5 mm ² ; insulated; 110 mm long; black	www.wago.com/2009-414
	Item no.: 2009-416 Push-in type wire jumper; 1.5 mm ² ; insulated; 250 mm long; black	www.wago.com/2009-416
	Item no.: 2009-414/000-005 Push-in type wire jumper; 1.5 mm ² ; insulated; 110 mm long; black	www.wago.com/2009-414/000-005
	Item no.: 2009-414/000-006 Push-in type wire jumper; insulated; 110 mm long; black	www.wago.com/2009-414/000-006

Downloads
Documentation

Bid Text

2002-2971	2019 Apr 18	xml	Download
-----------	-------------	-----	----------

Subject to changes. Please also observe the further product documentation!

WAGO GmbH & Co. KG
 Hansastr. 27
 32423 Minden
 Phone: +49571 887-0 | Fax: +49571 887-169
 Email: info.de@wago.com | Web: www.wago.com

Do you have any questions about our products?
 We are always happy to take your call at +49 (571) 887-44222.



X81 - Datei			4.1 kB	
2002-2971		2019 Apr 18	docx	Download
docx - Datei			15.6 kB	

Additional Information

Technical Section			pdf	Download
Technical explanations			2.2 MB	

CAD/CAE-Data

CAD data

2D/3D Models 2002-2971			URL	Download
------------------------	--	--	-----	----------

CAE data

EPLAN Data Portal 2002-2971			URL	Download
-----------------------------	--	--	-----	----------

ZUKEN Portal 2002-2971			URL	Download
------------------------	--	--	-----	----------

WSCAD Universe 2002-2971			URL	Download
--------------------------	--	--	-----	----------

Environmental Product Compliance

Compliance Search

Environmental Product Compliance 2002-2971			URL	Download
--	--	--	-----	----------

Double-deck disconnect terminal block; with pivoting knife disconnect; same profile as double-deck, double-disconnect terminal block; L/L; for DIN-rail 35 x 15 and 35 x 7.5; 2.5 mm²; Push-in CAGE CLAMP®; 2,50 mm²; gray

Installation Notes

Subject to changes. Please also observe the further product documentation!

WAGO GmbH & Co. KG
 Hansastr. 27
 32423 Minden
 Phone: +49571 887-0 | Fax: +49571 887-169
 Email: info.de@wago.com | Web: www.wago.com

Do you have any questions about our products?
 We are always happy to take your call at +49 (571) 887-44222.

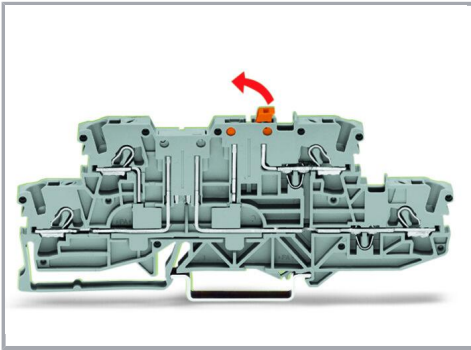

Double-deck disconnect terminal block
(2002-2971)

Opening a knife disconnect.

Testing

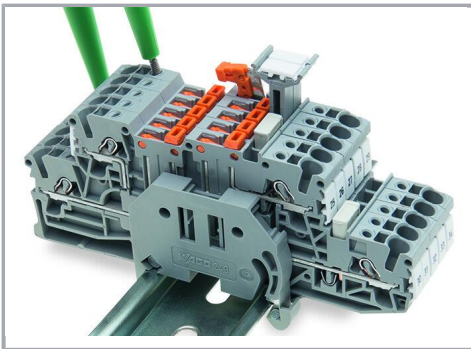

Testing with voltage tester.

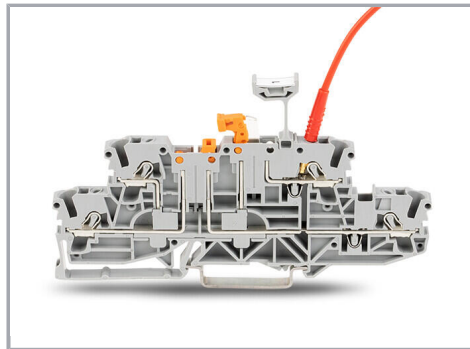

Double-deck, double-disconnect terminal
block (2002-2951) with group marker carrier
(2002-160) accommodated in a jumper
contact slot and test plug (210-136)

Marking

Subject to changes. Please also observe the further product documentation!

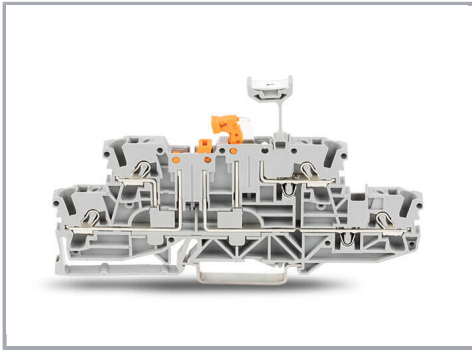

Double-deck, double-disconnect terminal block (2002-2951) with group marker carrier (2002-160) accommodated in jumper contact slot

Product family

TOPJOB® S

TOPJOB® S: In various industrial applications and modern building installations, WAGO's wide and versatile range of rail-mount terminal blocks provides more than just reliable electrical connections.

[Show all products from the family](#)

Subject to changes. Please also observe the further product documentation!