

Data sheet | Item number: 890-874

Plug for PCBs; straight; 4-pole; Cod. B; light green

www.wago.com/890-874



Color: 

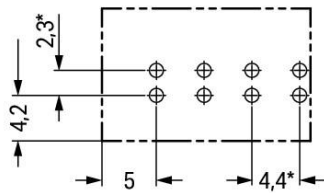
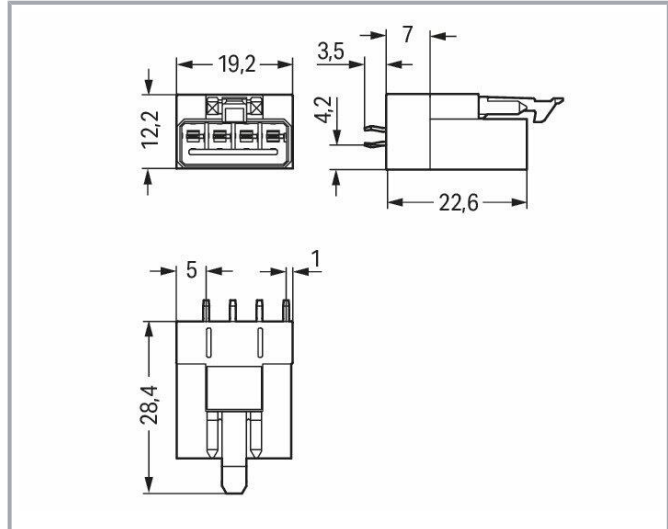

* ± 0.05 mm

Drilled hole diameter: 1.3^{+0.1} mm

Subject to changes. Please also observe the further product documentation!

WAGO GmbH & Co. KG

Hansastr. 27

32423 Minden

Phone: +49571 887-0 | Fax: +49571 887-169

Email: info.de@wago.com | Web: www.wago.com

Do you have any questions about our products?

We are always happy to take your call at +49 (571) 887-44222.



Item description

Male connector/plug *WINSTA*® MINI rated current 16 A

WAGO offers various connection technology solutions for connecting devices, for example, the *WINSTA*® MINI male connector/plug. Our remarkable number of pluggable PCB connectors with various insertion directions and operating variants offers you the right solution for your application at any time. The coding options reduce installation errors, allowing fast, secure wiring of all components. B coding enables the *WINSTA*® MINI pcb connectors to be used for control in applications in automation, mechanical engineering and robotics. *WINSTA*® MINI satisfies the demand for miniaturisation. Our smallest pluggable connection system is very good for lights, for example, since as a result of LED technology; due to complex systems, these offer much less space for the connection technology.

Lower costs through fast commissioning and elimination of service expenses – solutions from *WINSTA*® MINI

The *WINSTA*® Pluggable Connection System is ideally tailored to the very strict requirements of building installation. It makes electrical installation pluggable, and therefore more efficient, more reliable, and error-free. Use of this pre-assembled system reduces assembly times and errors during installation at the construction site. Now you can also reduce installation expenses without compromising quality and safety: The *WINSTA*® MINI pcb connector with protection against mismatching reduces the need for servicing and prevents unnecessary downtime.

- protection against mismatching eliminates errors
- consistent IP40 protection
- for automation controllers
- quick replacement of defective units during ongoing operation

Data

Notes

Variants:

Other pole markings

Other versions (or variants) can be requested from WAGO Sales or configured at <https://configurator.wago.com/>.

Electrical data

Ratings per IEC/EN

Ratings per	IEC/EN 60664-1
Nominal voltage (III/3)	250 V
Rated impulse voltage (III/3)	4 kV

Subject to changes. Please also observe the further product documentation!

WAGO GmbH & Co. KG
Hansastr. 27
32423 Minden
Phone: +49571 887-0 | Fax: +49571 887-169
Email: info.de@wago.com | Web: www.wago.com

Do you have any questions about our products?
We are always happy to take your call at +49 (571) 887-44222.



Rated current	16 A
Note (rated current)	13 A for 3-pole load 10 A for 4-pole load
Legend (ratings)	(III / 3) $\hat{=}$ Overvoltage category III / Pollution degree 3

Ratings per UL 1977

Note for the US market	Some versions may also be used for current interruption in accordance with the UL certificate in select applications with currents below 5 A and voltages up to 600 V. For further information, please contact your local sales office.
Rated voltage (UL 1977)	600 V
Rated current UL 1977	12 A

General

Note on contact resistance	approx. 1 m Ω of contact resistance approx. 0.25 m Ω contact transition plug/socket
----------------------------	------------------------------------------------------------------------------------------------------

Connection data

Total number of potentials	4
Number of levels	1

Connection 1

Pole number	4
-------------	---

Physical data

Pin spacing	4.4 mm / 0.173 inches
Width	19.2 mm / 0.756 inches
Height	31.9 mm / 1.256 inches
Height from the surface	28.4 mm / 1.118 inches
Depth	12.2 mm / 0.48 inches
Solder pin length	3.5 mm
Solder pin dimensions	1 x 0.8 mm
Drilled hole diameter with tolerance	1.3 ^(+0.1) mm

Mechanical Data

Application	Control technology
-------------	--------------------

Subject to changes. Please also observe the further product documentation!



Coding	B
Variable coding	No
Marking	4 3 2 1
Potential marking	4 3 2 1
Mating force of a plug-in connection	approx. 20 ... 70 N (depending on pole number)
Retention force of a plug-in connection	Locked: > 80 N
Unmating force of a plug-in connection	Unlocked: approx. 20 ... 70 N (depending on pole number)
Number of mating cycles	200, without resistive load 100, with resistive load $I_N = 16$ A, tested (1.5 mm ²)
Design	straight

Plug-in connection

Contact type (pluggable connector)	Male connector/plug
Connector (connection type)	for PCB
Mismating protection	Yes
Note on mismating protection	All <i>WINSTA</i> [®] components are 100% protected against mismating when: a.) plugging different numbers of poles b.) plugging while rotated 180 c.) plugging while laterally staggered d.) plugging one pole
Mating direction to the PCB	90 °
Locking lever	yes
Locking of plug-in connection	locking lever
Note on locking system	All connectors for mounted installations (snap-in versions for lighting fixtures or devices, all types of PCB and distribution connectors) are factory-equipped with locking levers to ensure plugs and sockets are securely locked. Additional locking levers are only required for flying leads (plug/socket).

PCB contact

PCB contact	THT
Solder pin arrangement	2 in-line solder pins/pole
Number of solder pins per potential	2

Subject to changes. Please also observe the further product documentation!



Material Data

Note (material data)

Information on material specifications can be found here

Color	light green
Cover color	gray
Material group	I
Insulation material	Polyamide (PA66)
Flammability class per UL94	V0
Clamping spring material	Chrome-nickel spring steel (CrNi)
Contact material	Copper or copper alloy; surface-treated
Contact plating	Tin
Fire load	0.077 MJ
Weight	4 g

Environmental requirements

Processing temperature	-5 ... +40 °C
Continuous operating temperature	-35 ... +85 °C
Note on continuous operating temperature	Insulating parts for temperatures ≤ 105 °C

Commercial data

Product Group	20 (Winsta)
eCl@ss 10.0	27-44-06-05
eCl@ss 9.0	27-44-06-05
ETIM 8.0	EC002560
ETIM 7.0	EC002560
PU (SPU)	50 pcs
Packaging type	box
Country of origin	PL
GTIN	4050821696131
Customs tariff number	85366990990

Environmental Product Compliance

RoHS Compliance Status	Compliant, No Exemption
------------------------	-------------------------



Approvals / Certificates

Subject to changes. Please also observe the further product documentation!



WAGO GmbH & Co. KG
 Hansastr. 27
 32423 Minden
 Phone: +49571 887-0 | Fax: +49571 887-169
 Email: info.de@wago.com | Web: www.wago.com

Do you have any questions about our products?
 We are always happy to take your call at +49 (571) 887-44222.



General approvals

Logo	Approval	Additional Approval Text	Certificate name
	CB DEKRA Certification B.V.	IEC 61984	NL-64351
	CB DEKRA Certification B.V.	EN 61984	71-112993
	cURus Underwriters Laboratories Inc.	UL 1977	E45171
	KEMA/KEUR DEKRA Certification B.V.	EN 60320	2148952.04

Declarations of conformity and manufacturer's declarations

Logo	Approval	Additional Approval Text	Certificate name
	EU-Declaration of Conformity WAGO GmbH & Co. KG	-	-
	UK-Declaration of Conformity WAGO GmbH & Co. KG	-	-

Approvals for marine applications

Logo	Approval	Additional Approval Text	Certificate name
	DNV GL Det Norske Veritas, Germanischer Lloyd	-	TAE00001Z6
	LR Lloyds Register	EN 61535	08/20047 (E2)

Subject to changes. Please also observe the further product documentation!

Counterpart



Item no.890-264

Socket; 4-pole; Cod. B; 1,50 mm²; light green

www.wago.com/890-264



Item no.891-8994/005-105

pre-assembled interconnecting cable; Eca; Socket/plug; 4-pole; Cod. B; Control cable 4 x 1.0 mm²; 1 m; 1,00 mm²; light green

www.wago.com/891-8994/005-105



Item no.891-8994/105-105

pre-assembled connecting cable; Eca; Socket/open-ended; 4-pole; Cod. B; Control cable 4 x 1.0 mm²; 1 m; 1,00 mm²; light green

www.wago.com/891-8994/105-105

Downloads

CAD/CAE-Data

CAD data

2D/3D Models 890-874

URL

Download

PCB Design

Symbol and Footprint 890-874

URL

Download

CAx data for your PCB design, consisting of "schematic symbols and PCB footprints", allow easy integration of the WAGO component into your development environment.

Supported formats:

- Accel EDA 14 & 15
- Altium 6 to current version
- Cadence Allegro
- DesignSpark
- Eagle Libraries
- KiCad
- Mentor Graphics BoardStation
- Mentor Graphics Design Architect
- Mentor Graphics Design Expedition 99 and 2000
- OrCAD 9.X PCB and Capture
- PADS PowerPCB 3, 3.5, 4.X, and 5.X
- PADS PowerPCB and PowerLogic 3.0
- PCAD 2000, 2001, 2002, 2004, and 2006
- Pulsonix 8.5 or newer
- STL
- 3D STEP

Subject to changes. Please also observe the further product documentation!

WAGO GmbH & Co. KG

Hansastr. 27

32423 Minden

Phone: +49571 887-0 | Fax: +49571 887-169

Email: info.de@wago.com | Web: www.wago.com

Do you have any questions about our products?

We are always happy to take your call at +49 (571) 887-44222.



- TARGET 3001!
- View Logic ViewDraw
- Quadcept
- Zuken CadStar 3 and 4
- Zuken CR-5000 and CR-8000

PCB Component Libraries (EDA), PCB CAD Library Ultra Librarian

CAE data

ZUKEN Portal 890-874	URL	Download
----------------------	---------------------	--------------------------

Environmental Product Compliance

Compliance Search

Environmental Product Compliance 890-874 Plug for PCBs; straight; 4-pole; Cod. B; light green	URL	Download
--------------------------------------------------------------------------------------------------	---------------------	--------------------------

Installation Notes

Product family

WINSTA® MINI

[Show all products from the family](#)

Subject to changes. Please also observe the further product documentation!