

# XT230A1FAL2

Telemecanique Capacitive proximity sensors  
XT, cylindrical M30, plastic, Sn 15 mm, cable 2  
m



## Main

Range of Product	Telemecanique Capacitive proximity sensors XT
Sensor Type	Capacitive proximity sensor
Product Specific Application	Detection of insulated or conductive materials
Sensor name	XT2
Sensor design	Cylindrical M30
Size	74.5 mm
Body type	Fixed
Detector flush mounting acceptance	Non flush mountable
Material	Plastic
Enclosure Material	Plastic
Type of output signal	Discrete
Wiring Technique	2-wire
[Sn] nominal sensing distance	0.59 in (15 mm)
Discrete output function	1 NO
Output circuit type	AC
Electrical connection	Cable
Cable length	6.56 ft (2 m)
[Us] rated supply voltage	24...240 V AC 50...60 Hz
Maximum delay response	30 ms
IP degree of protection	IP67 double insulation conforming to IEC 60529

## Complementary

ISO thread	M30 x 1.5
Detection face	Frontal
[Sa] assured operating distance	0.00...0.43 in (0...11 mm)
Adjustment zone	0.00...0.67 in (0...17 mm)
Differential travel	< 1...20 % Sr
Repeat accuracy	< 5 % Sr
Wire insulation material	PVC
Status LED	Output state indication 1 LED yellow)
Supply voltage limits	20...265 V AC
Switching frequency	<= 25 Hz
Maximum voltage drop	<10 V closed)
Current consumption	< 4 mA
Maximum delay first up	200 ms
Maximum delay recovery	30 ms
Maximum switching current	300 mA
Marking	CE
Setting-up	Sensitivity by potentiometer
Threaded length	1.91 in (48.5 mm)
Length	2.93 in (74.5 mm)
Net Weight	0.60 lb(US) (0.27 kg)

## Environment

Standards	EN/IEC 60947-5-2
Product Certifications	cULus
Ambient air temperature for operation	14...140 °F (-10...60 °C)
Vibration resistance	10 gn 1 mm 10...55 Hz)IEC 60068-2-6
Shock resistance	30 gn 11 ms IEC 60068-2-27
Resistance to electrostatic discharge	4 KV contact IEC 61000-4-2 8 kV air IEC 61000-4-2
Resistance to electromagnetic fields	2.74 V/m (3 V/m) IEC 61000-4-3
Resistance to fast transients	2 kV IEC 61000-4-4

## Ordering and shipping details

Category	22490 - SENSORS-ULTRASONIC (XX5,6)
Discount Schedule	DS2
GTIN	3389119026017
Nbr. of units in pkg.	1
Package weight(Lbs)	5.36 oz (152 g)
Returnability	Yes
Country of origin	CN

## Packing Units

Unit Type of Package 1	PCE
Package 1 Height	0.98 in (2.5 cm)
Package 1 width	8.27 in (21 cm)
Package 1 Length	5.91 in (15 cm)
Unit Type of Package 2	S02
Number of Units in Package 2	30
Package 2 Weight	11.06 lb(US) (5.018 kg)
Package 2 Height	5.91 in (15 cm)
Package 2 width	11.81 in (30 cm)
Package 2 Length	15.75 in (40 cm)

## Offer Sustainability

California proposition 65	WARNING: This product can expose you to chemicals including: Diisononyl phthalate (DINP), which is known to the State of California to cause cancer, and Di-isodecyl phthalate (DIDP), which is known to the State of California to cause birth defects or other reproductive harm. For more information go to <a href="http://www.P65Warnings.ca.gov">www.P65Warnings.ca.gov</a>
REACH Regulation	<a href="#">REACH Declaration</a>
REACH free of SVHC	Yes
EU RoHS Directive	Pro-active compliance (Product out of EU RoHS legal scope) <a href="#">EU RoHS Declaration</a>
Toxic heavy metal free	Yes
Mercury free	Yes
RoHS exemption information	<a href="#">Yes</a>

## Contractual warranty

Warranty	18 months
----------	-----------

Dimensions

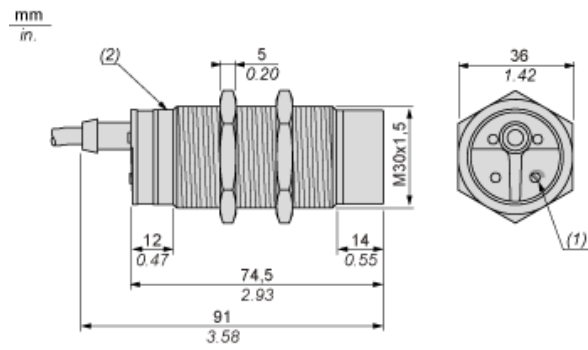

- (1) Adjustment potentiometer
- (2) LED

## Setting-up

### Minimum Mounting Distances (mm)

Side by side

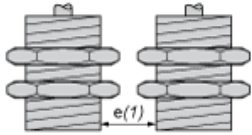

$e(1) \geq 60$

$\geq$

Face to face

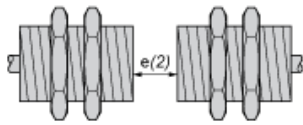

$e(2) \geq 90$

$\geq$

Facing a metal object

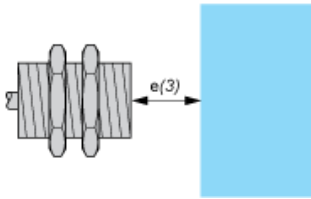

$e(3) \geq 45$

$\geq$

Mounted in support

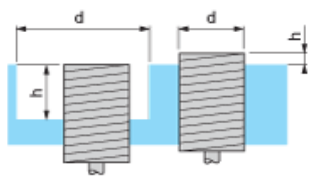

$d \geq 90$

$h \geq 30$

Fixing nut tightening torque: 8 N.m

## Adjustment

### Sensitivity Adjustment

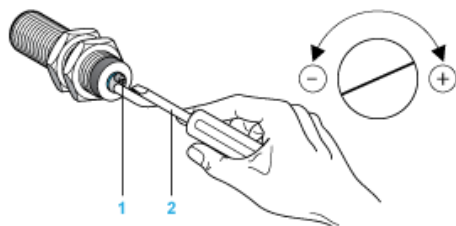

(1) Adjustment potentiometer

(2) Screwdriver (included with sensor)

---

## Wiring Diagram

---

### Pre-cabled

2-wire AC NO Output

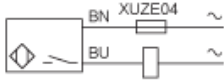

(BU) Blue  
(BN) Brown