

**PLUG MATED TO R/A RECEPTACLE
MATED PROFILE**

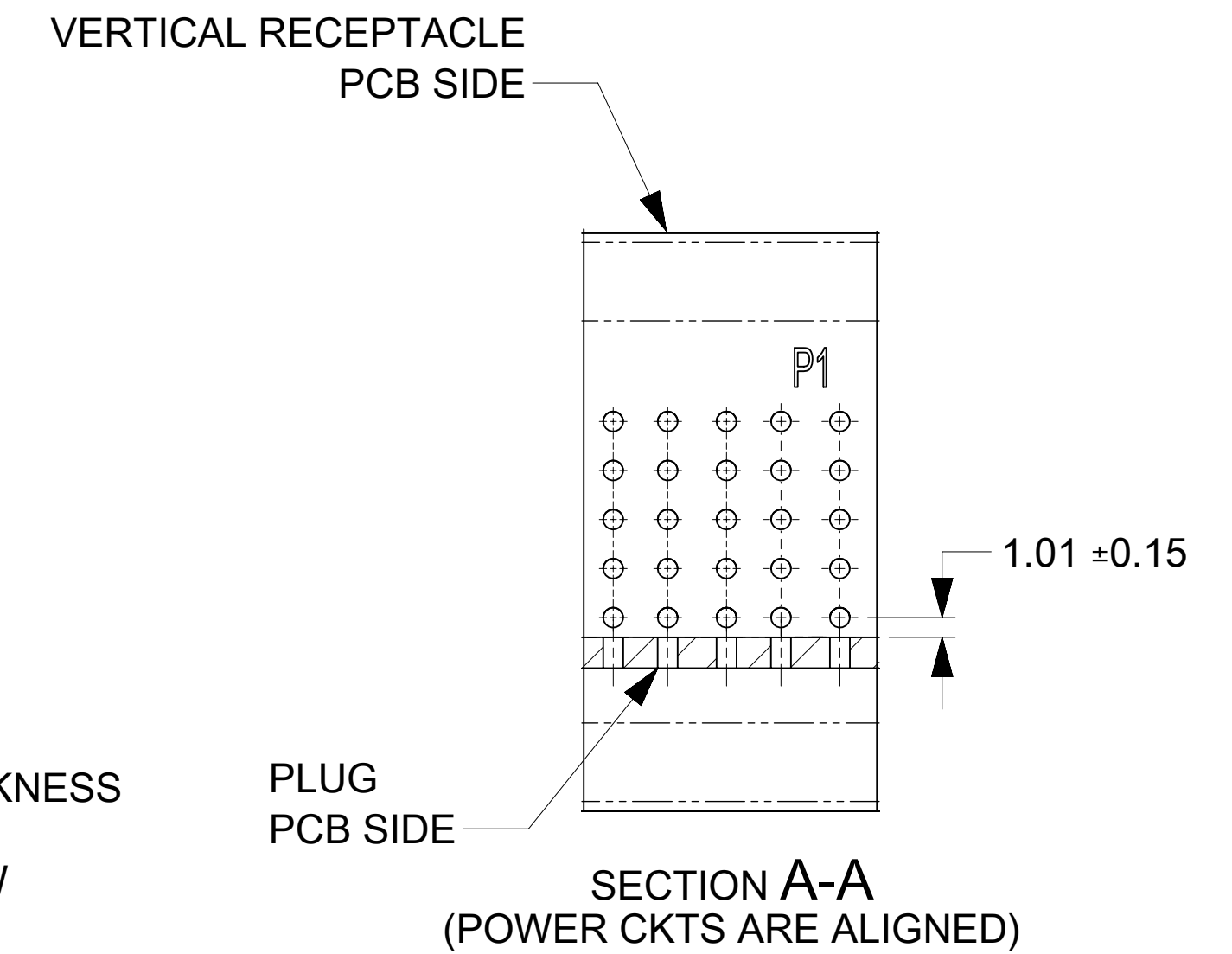

**PLUG MATED TO VERTICAL RECEPTACLE
MATED PROFILE**

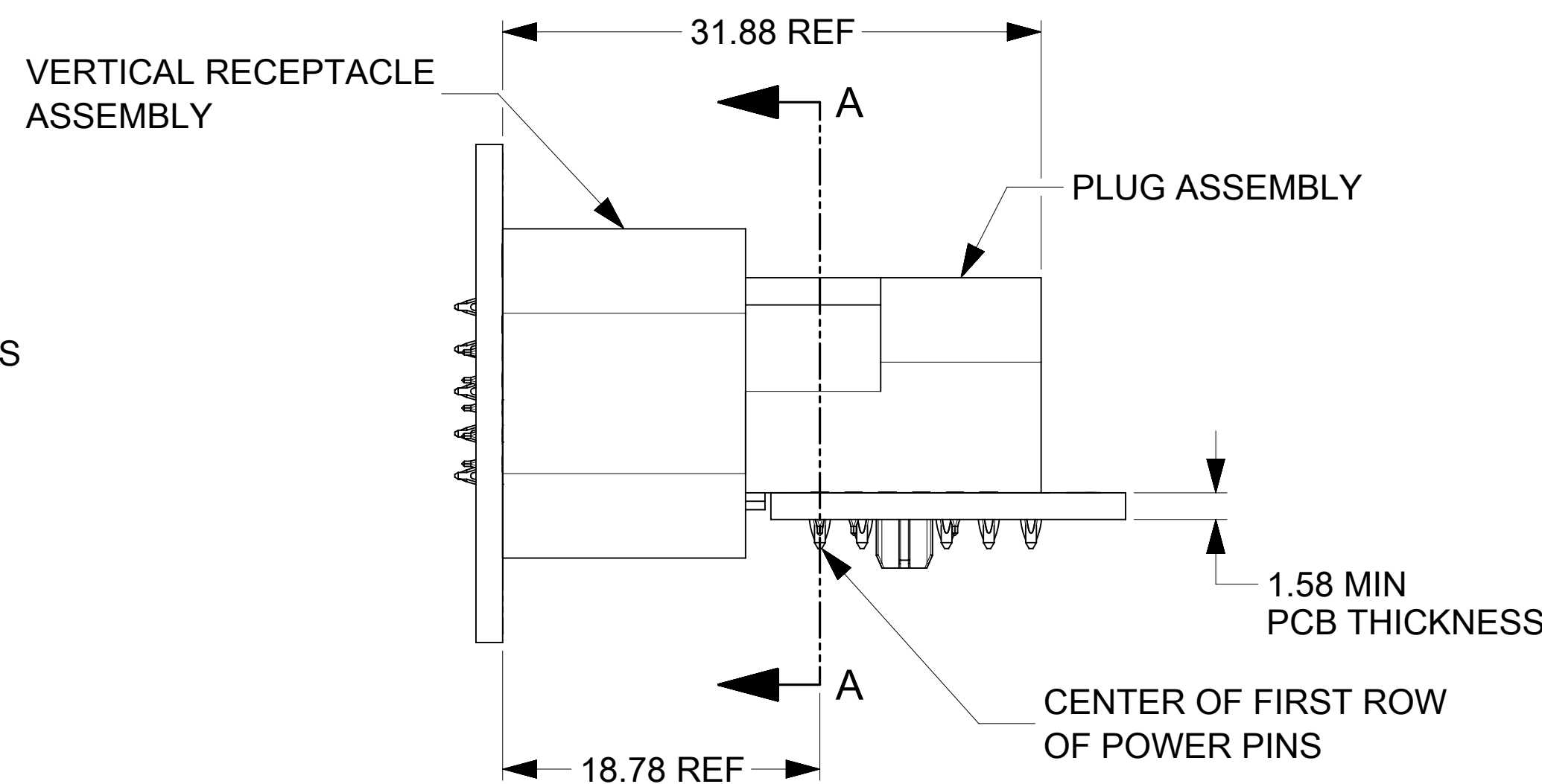
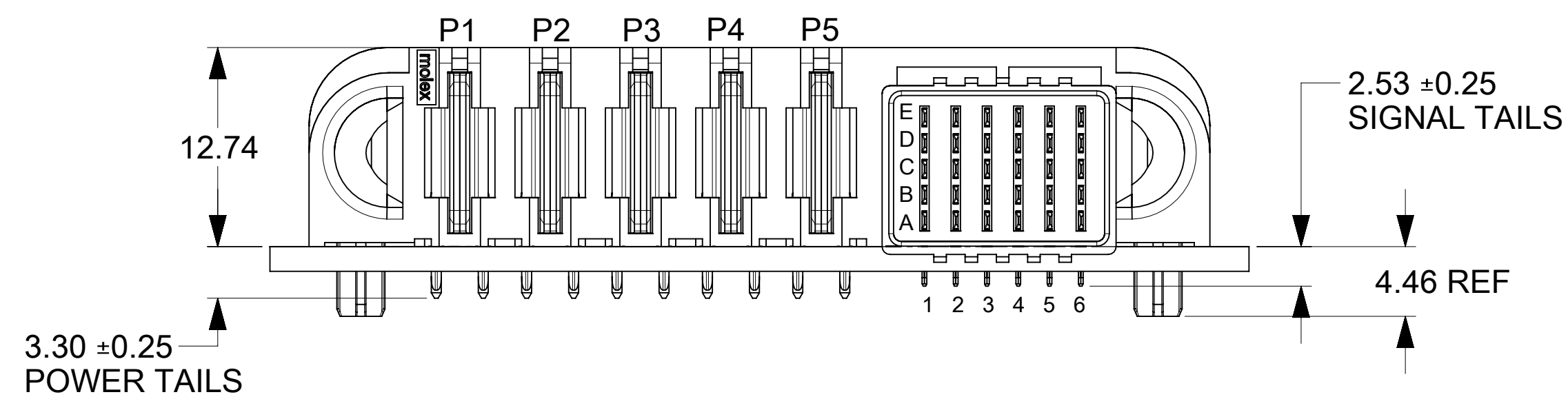
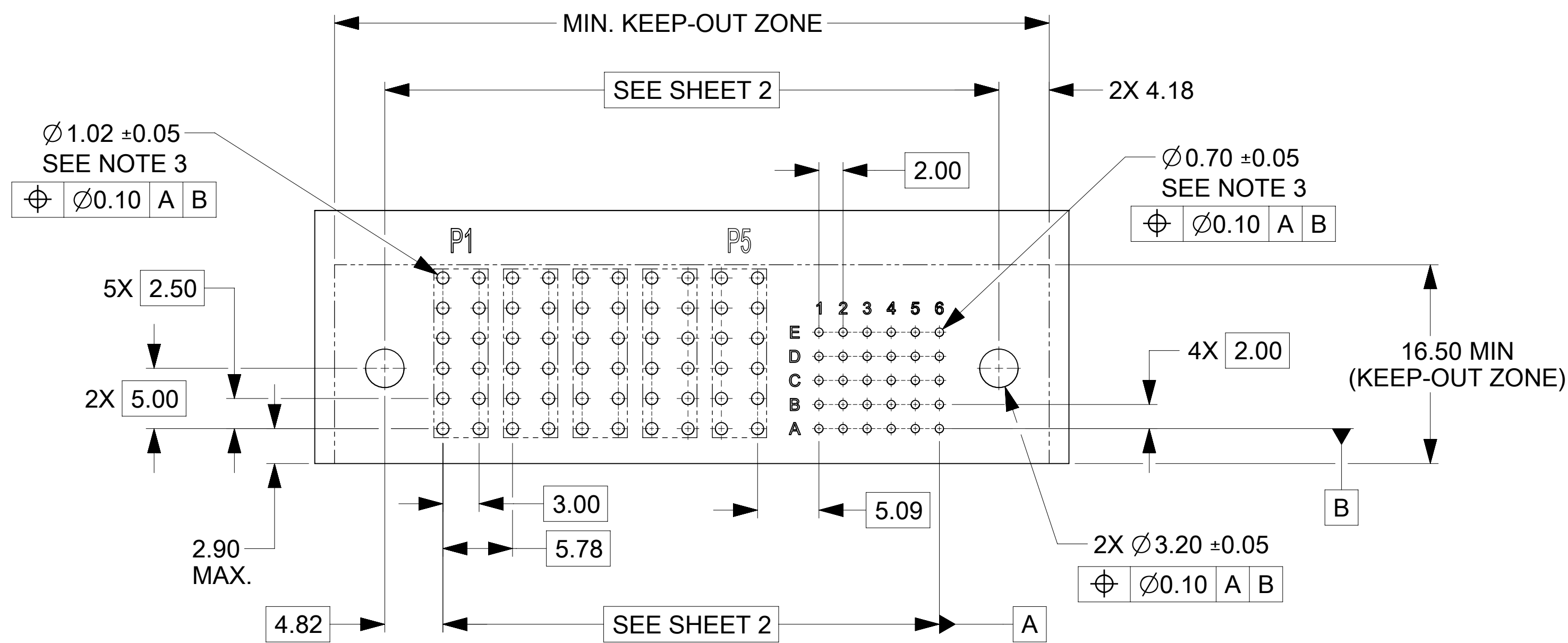

NOTES:

- MATERIAL:**
 -HOUSINGS: LCP UL94, V-0, COLOR : BLACK
 -TERMINALS: HIGH CONDUCTIVITY COPPER ALLOY
 -PLATING: 1.27 μm (50 μin) NICKEL OVERALL WITH
 2.54 μm (100 μin) SELECTIVE TIN ON TAILS AND
 0.762 μm (30 μin) SELECTIVE GOLD ON CONTACT AREA
- PACKAGING:** ASSEMBLIES TO BE TRAY PACKED PER PACKAGING SPEC: 2141130010-PK.
- PLATED THRU HOLE SIZE,** REFER TO PRODUCT SPEC. FOR DETAILS.
- PRODUCT SPEC:** 2141130000-PS.
- PRODUCT TO MEET RoHS REQUIREMENTS.**
- PLUG ASSEMBLY MATES TO MOLEX RECEPTACLES** 219563XXXX-SD AND 219564XXXX-SD, SEE DRAWINGS FOR DETAILS.
- TAIL DESIGN: COMPLIANT PIN.**
- POWER TERMINALS AND SIGNALS ARE LUBRICATED.**
- APPLICATION SPECIFICATION: 2141130000-AS (FOR COMPLIANT TAILS ONLY).**

THIS DRAWING CONTAINS INFORMATION THAT IS PROPRIETARY TO MOLEX ELECTRONIC TECHNOLOGIES, LLC AND SHOULD NOT BE USED WITHOUT WRITTEN PERMISSION									
DIMENSION UNITS		SCALE		CURRENT REV DESC:					
mm		3:1							
GENERAL TOLERANCES (UNLESS SPECIFIED)									
ANGULAR TOL		± °		EC NO: 745288					
4 PLACES		±		DRWN: LZABJANOVSKI		2023/03/09			
3 PLACES		±		CHK'D: JAYK1		2023/04/10			
2 PLACES		± 0.25		APPR: JAYK1		2023/04/10			
1 PLACE		± 0.3		INITIAL REVISION:					
0 PLACES		±		DRWN: LZABJANOVSKI		2022/03/14			
				APPR: BPISZCZOR		2022/08/04			
DRAFT WHERE APPLICABLE MUST REMAIN WITHIN DIMENSIONS				THIRD ANGLE PROJECTION		DRAWING		SERIES	
				D-SIZE		219562			
				MATERIAL NUMBER		CUSTOMER		SHEET NUMBER	
				SEE CHART				1 OF 2	

RECOMMENDED PCB LAYOUT AND KEEP-OUT ZONE



GUARDIAN HD RA PLUG RIGHT SIGNAL WITH POWER PF

PRODUCT CUSTOMER DRAWING

DOCUMENT NUMBER	DOC TYPE	DOC PART	REVISION
2195629001-SD	PSD	000	A1

PART NUMBER	CONFIGURATION	QUANTITY PER CARTON (DU)
219562-0011	G+1P+15S+G	135

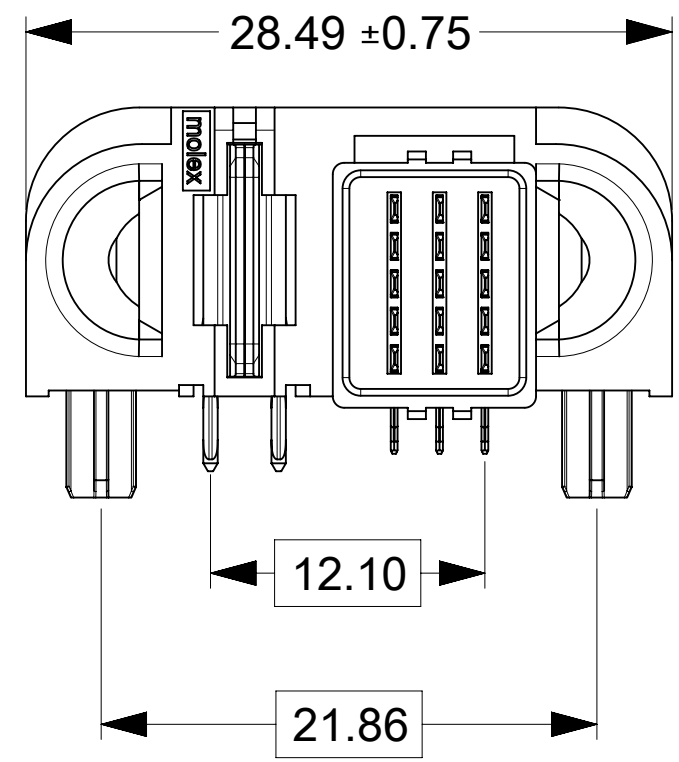

PART NUMBER	CONFIGURATION	QUANTITY PER CARTON (DU)
219562-0012	G+2P+15S+G	105

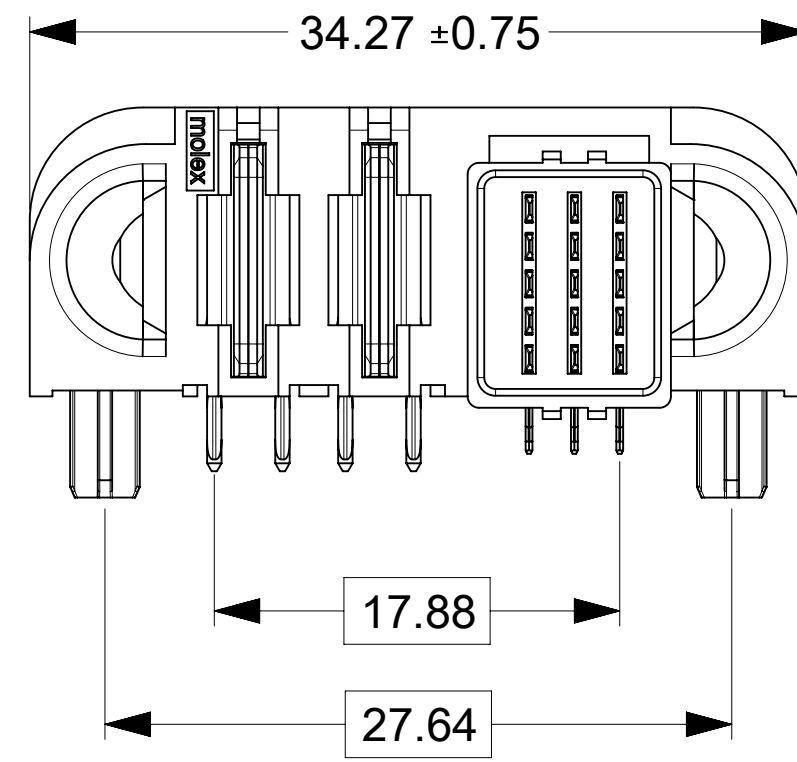

PART NUMBER	CONFIGURATION	QUANTITY PER CARTON (DU)
219562-0013	G+3P+15S+G	90

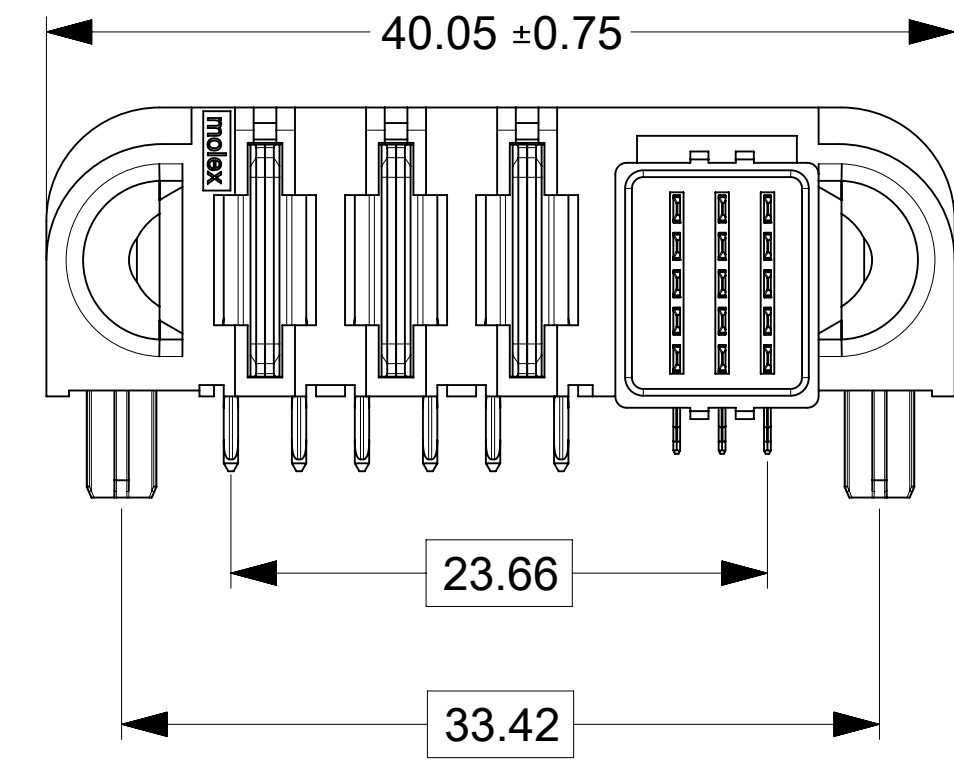

PART NUMBER	CONFIGURATION	QUANTITY PER CARTON (DU)
219562-0014	G+4P+15S+G	75

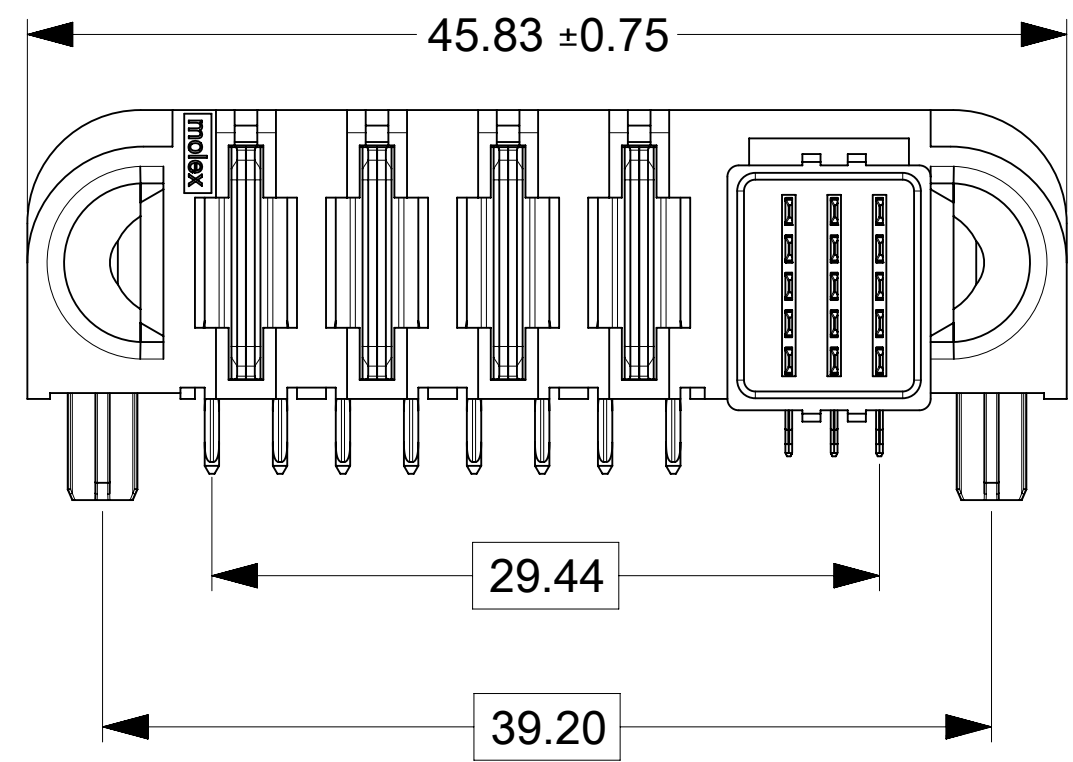

PART NUMBER	CONFIGURATION	QUANTITY PER CARTON (DU)
219562-0015	G+5P+15S+G	75

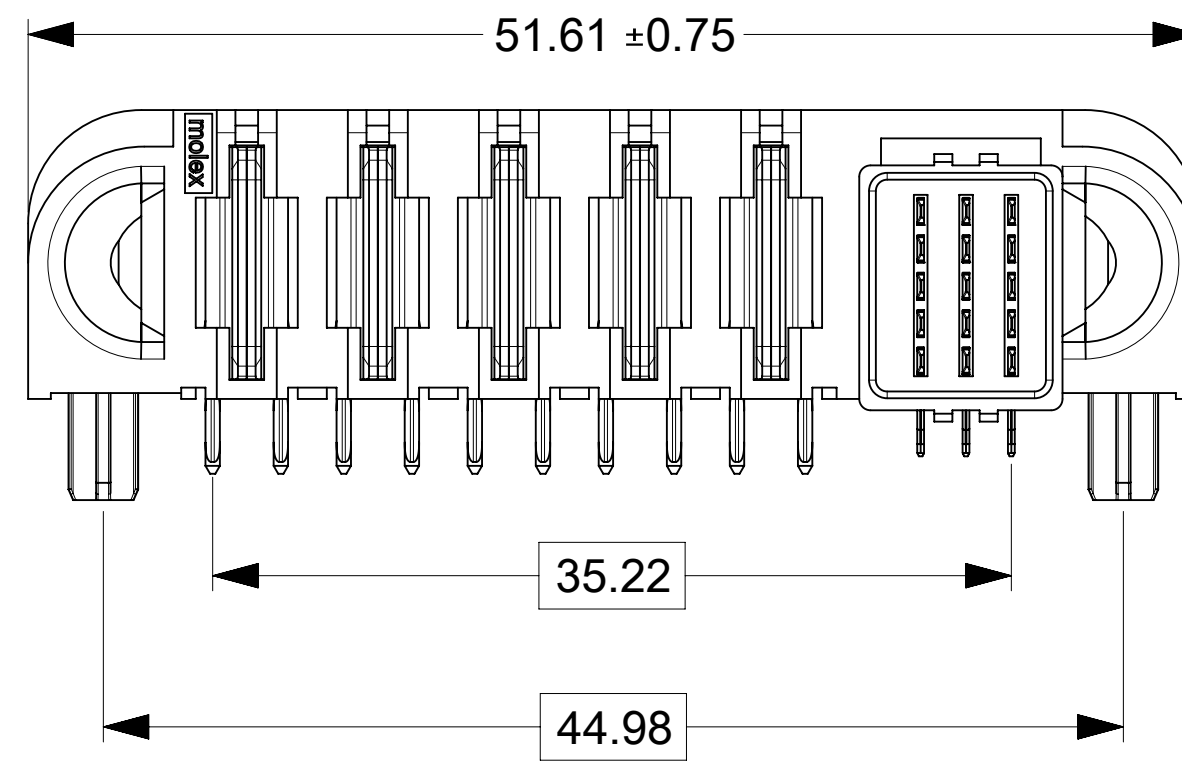

PART NUMBER	CONFIGURATION	QUANTITY PER CARTON (DU)
219562-0016	G+1P+30S+G	105

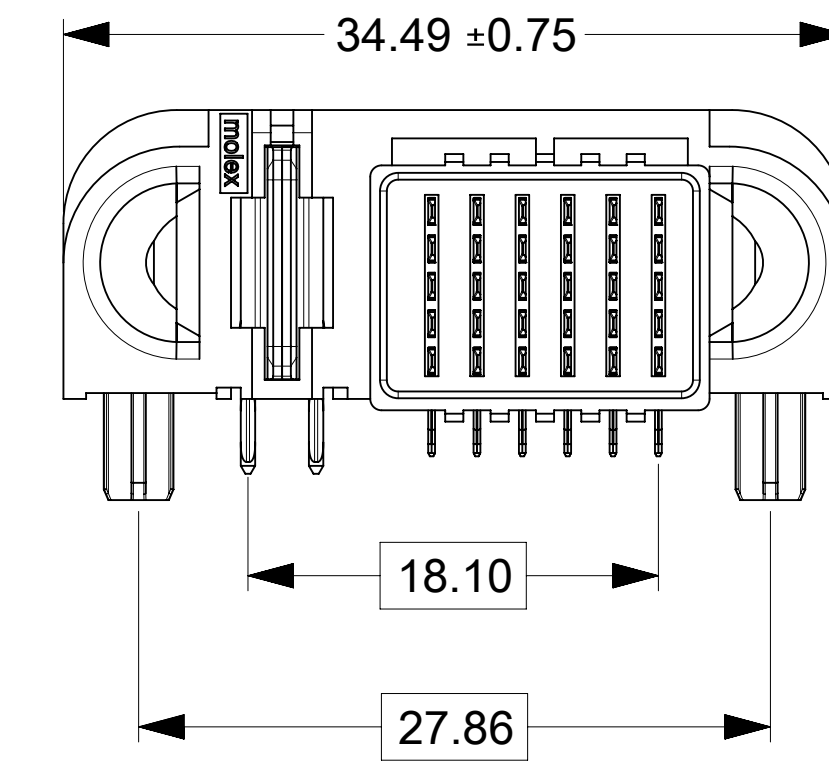

PART NUMBER	CONFIGURATION	QUANTITY PER CARTON (DU)
219562-0017	G+2P+30S+G	90

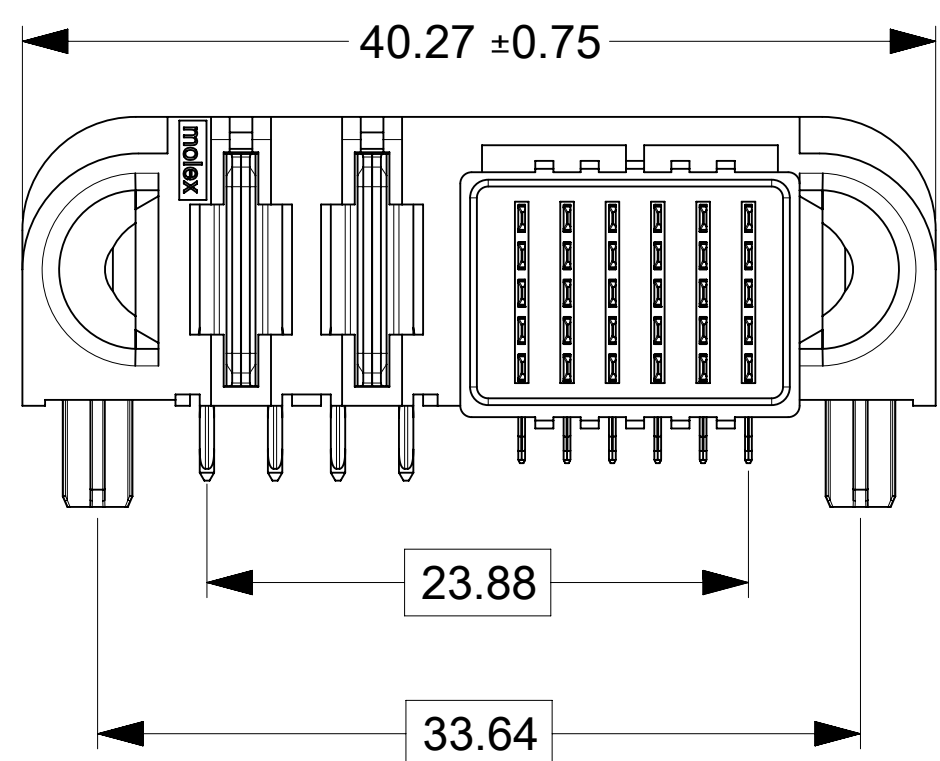

PART NUMBER	CONFIGURATION	QUANTITY PER CARTON (DU)
219562-0018	G+3P+30S+G	75

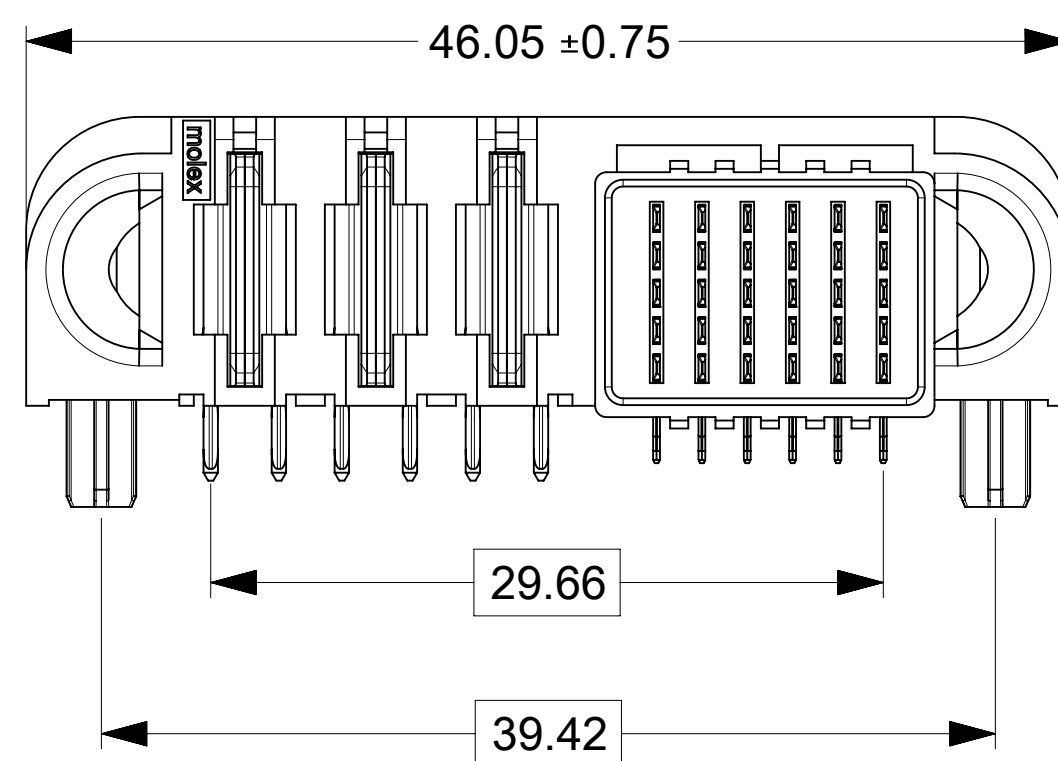

PART NUMBER	CONFIGURATION	QUANTITY PER CARTON (DU)
219562-0019	G+4P+30S+G	75

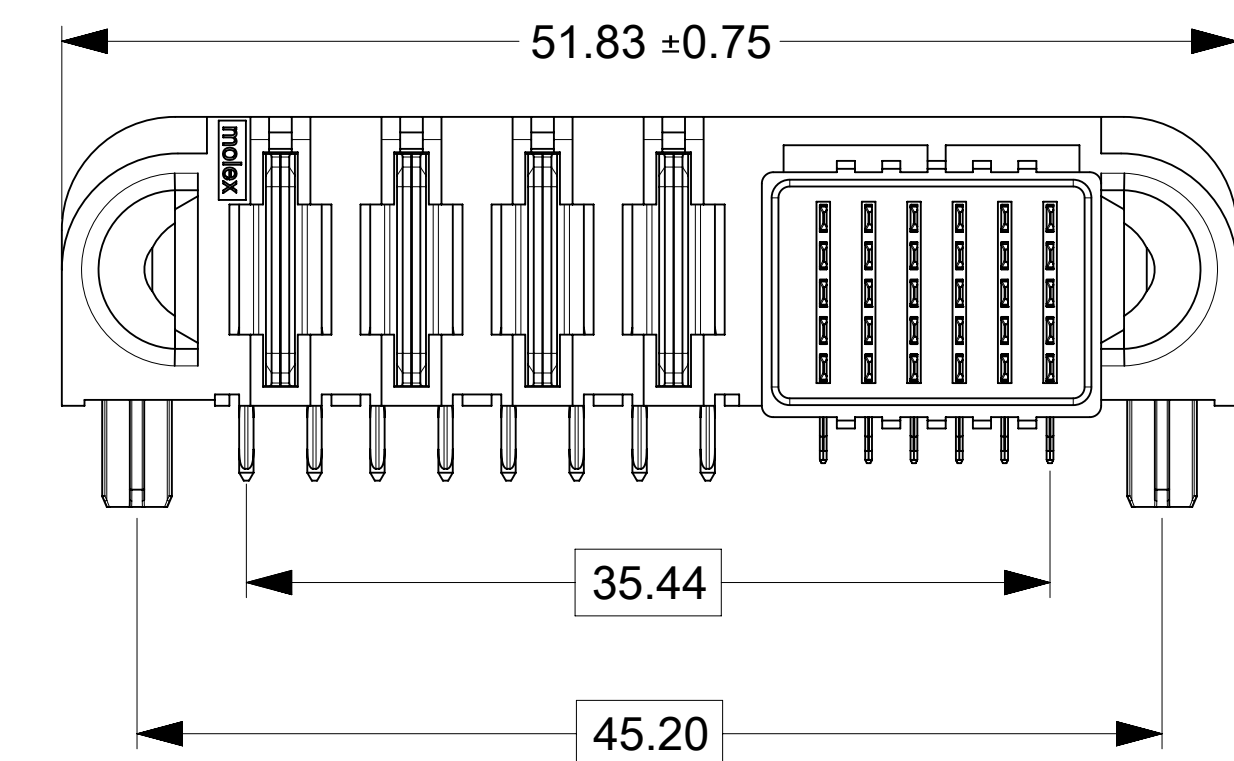

PART NUMBER	CONFIGURATION	QUANTITY PER CARTON (DU)
219562-0020	G+5P+30S+G	60

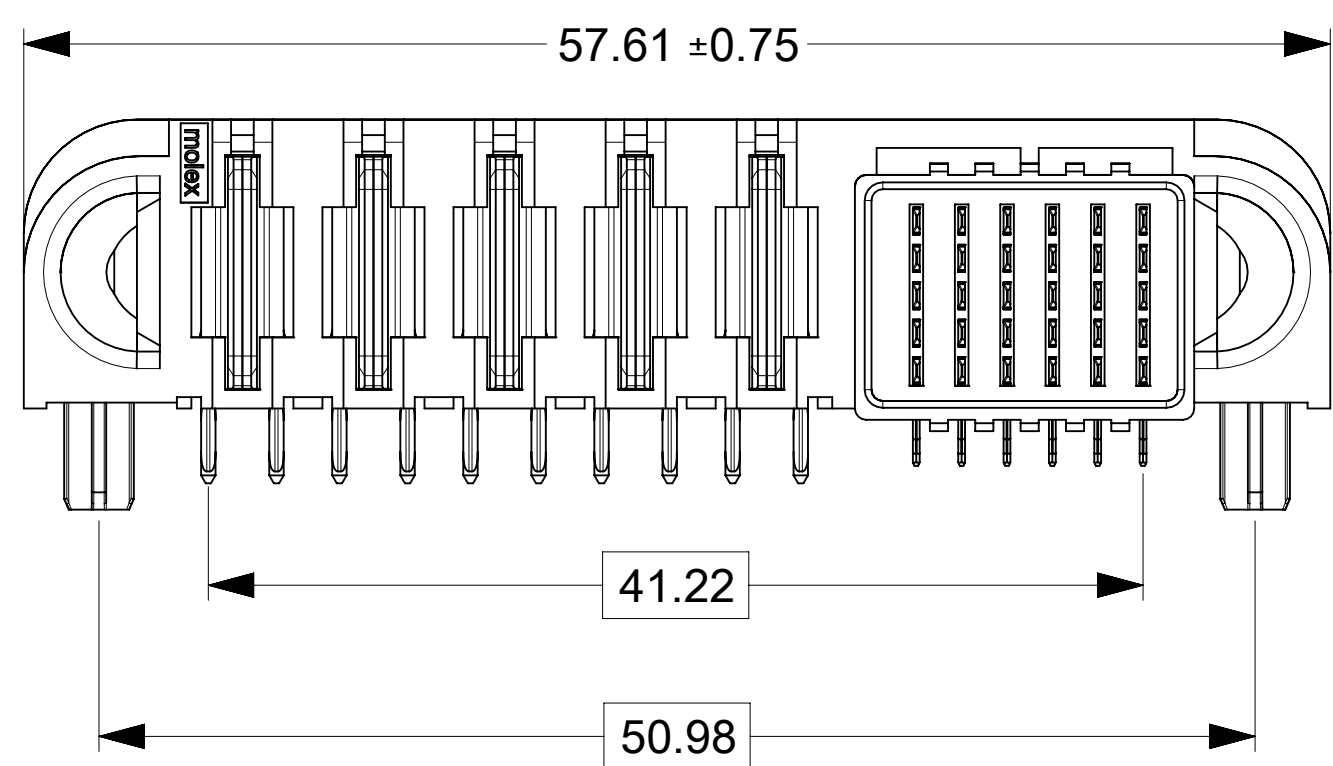

THIS DRAWING CONTAINS INFORMATION THAT IS PROPRIETARY TO MOLEX ELECTRONIC TECHNOLOGIES, LLC AND SHOULD NOT BE USED WITHOUT WRITTEN PERMISSION

DIMENSION UNITS	SCALE	CURRENT REV DESC:
mm	3:1	
GENERAL TOLERANCES (UNLESS SPECIFIED)		
ANGULAR TOL	±	°
4 PLACES	±	
3 PLACES	±	
2 PLACES	±	0.25
1 PLACE	±	0.3
0 PLACES	±	
DRAFT WHERE APPLICABLE MUST REMAIN WITHIN DIMENSIONS		
THIRD ANGLE PROJECTION	DRAWING	SERIES
	D-SIZE	219562

EC NO: 745288		
DRWN: LZABJANOVSKI	2023/03/09	
CHK'D: JAYK1	2023/04/10	
APPR: JAYK1	2023/04/10	
INITIAL REVISION:		
DRWN: LZABJANOVSKI	2022/03/14	
APPR: BPISZCZOR	2022/08/04	

DOCUMENT NUMBER			DOC TYPE	DOC PART	REVISION
2195629001-SD			PSD	000	A1
MATERIAL NUMBER		CUSTOMER		SHEET NUMBER	
SEE CHART				2 OF 2	

molex

GUARDIAN HD RA PLUG RIGHT SIGNAL WITH POWER PF

PRODUCT CUSTOMER DRAWING