

EVK-M8U

Evaluation Kit

User Guide



Abstract

This document describes the structure and use of the EVK-M8U evaluation kit and provides information for evaluating and testing u-blox M8 Untethered Dead Reckoning (UDR) positioning technology.

Document Information

| | | |
|-------------------------------|----------------|------------|
| Title | EVK-M8U | |
| Subtitle | Evaluation Kit | |
| Document type | User Guide | |
| Document number | UBX-15023994 | |
| Revision and date | R05 | 2-Nov-2018 |
| Disclosure restriction | | |

European Union regulatory compliance

EVK-M8U complies with all relevant requirements for RED 2014/53/EU. The EVK-M8U Declaration of Conformity (DoC) is available at www.u-blox.com within Support > Product resources > Conformity Declaration.

This document applies to the following products:

| Product name | Type number | Hardware version | ROM/FLASH version | PCN reference |
|---------------------|--------------------|-------------------------|--------------------------|----------------------|
| EVK-M8U | EVK-M8U-0-00 | D | Flash FW 3.01 UDR 1.21 | N/A |

u-blox or third parties may hold intellectual property rights in the products, names, logos and designs included in this document. Copying, reproduction, modification or disclosure to third parties of this document or any part thereof is only permitted with the express written permission of u-blox.

The information contained herein is provided "as is" and u-blox assumes no liability for its use. No warranty, either express or implied, is given, including but not limited to, with respect to the accuracy, correctness, reliability and fitness for a particular purpose of the information. This document may be revised by u-blox at any time without notice. For the most recent documents, visit www.u-blox.com.

Copyright © u-blox AG.

Contents

| | |
|--|-----------|
| Document Information | 2 |
| Contents | 3 |
| 1 Product description | 5 |
| 1.1 Overview..... | 5 |
| 1.2 Kit includes..... | 5 |
| 1.3 Evaluation software..... | 5 |
| 1.4 System requirements | 5 |
| 2 Specifications | 6 |
| 2.1 Safety precautions | 6 |
| 3 Device description | 7 |
| 3.1 Interface connection and measurement..... | 7 |
| 3.2 Active antenna..... | 7 |
| 3.3 Evaluation unit..... | 7 |
| 3.3.1 Antenna connector..... | 7 |
| 3.3.2 USB..... | 8 |
| 3.3.3 UART | 8 |
| 3.3.4 RST button..... | 8 |
| 3.3.5 Safe boot button..... | 8 |
| 3.3.6 Slide Switch | 8 |
| 3.3.7 Front test connector | 9 |
| 3.3.8 LED..... | 10 |
| 3.3.9 Backup battery..... | 10 |
| 3.3.10 GNSS configuration | 10 |
| 4 Setting up | 11 |
| 4.1 EVK-M8U installation..... | 11 |
| 4.1.1 Mounting the GNSS antenna..... | 11 |
| 4.1.2 Mounting the EVK-M8U..... | 11 |
| 4.1.3 Connecting the cables | 12 |
| 4.2 Recommended configuration | 12 |
| 4.2.1 Serial port default configuration | 12 |
| 4.2.2 UDR receiver operation..... | 12 |
| 4.3 Accelerated initialization and calibration procedure | 14 |
| 5 Test drives | 15 |
| 6 Measuring tracking current | 16 |
| 7 Block diagram | 17 |
| 8 Board layout | 18 |
| 9 Schematic | 20 |
| 10 Battery replacement | 21 |
| 11 Troubleshooting | 22 |
| 12 Common evaluation pitfalls | 24 |

| | |
|--------------------------------|-----------|
| Related documents | 26 |
| Revision history | 26 |
| Contact..... | 27 |

1 Product description

1.1 Overview

The EVK-M8U evaluation kit simplifies the evaluation of the high performance u-blox M8 Untethered Dead Reckoning positioning products. The built-in USB interface provides both power supply and high-speed data transfer, and eliminates the need for an external power supply. The u-blox evaluation kits are compact, and their user-friendly interface and power supply make them ideally suited for use in laboratories, vehicles and outdoor locations. Furthermore, they can be used with a PDA or a notebook PC, making them the perfect companion through all stages of design-in projects.

| Evaluation Kit | Description | Suitable for |
|----------------|--|------------------|
| EVK-M8U | u-blox M8 Evaluation Kit, 3D UDR with on-board sensors | NEO-M8U, EVA-M8E |

Table 1: List of products supported by EVK-M8U evaluation kit

1.2 Kit includes

- Evaluation unit
- USB cable
- Active GPS / GLONASS / BeiDou antenna with 3 m cable
- Quick Start card

1.3 Evaluation software

The u-center software installation package for the EVK can be downloaded from the Web: www.u-blox.com/en/evaluation-software-and-tools. Once the zip file is downloaded and unzipped, unzip the file in the Tools folder and double-click the extracted exe file. The software components will be installed on your system and placed under the “u-blox” folder in the “Start → Programs” menu.

The u-center application is an interactive tool for configuration, testing, visualization and data analysis of GNSS receivers. It provides useful assistance during all phases of a system integration project. The latest version of the u-center should be used.

1.4 System requirements

- PC with USB interface
- Operating system: Windows Vista onwards (x86 and x64 versions)
- USB drivers are provided in the evaluation kit installation software

2 Specifications

| Parameter | Specification |
|-------------------------------------|--|
| Serial Interfaces | 1 USB V2.0 |
| | 1 RS232, max. baud rate 921.6 kBd |
| | DB9 +/- 12 V level |
| | 14 pin – 3.3 V logic |
| | 1 DDC (I2C compatible) max. 400 kHz |
| | 1 SPI – clock signal max.5.5 MHz – SPI DATA max. 1 Mbit/s |
| Dimensions | 105 x 64 x 26 mm |
| Power Supply | 5V via USB or external powered via extra power supply pin 14 (V5_IN) and common supply/interface ground pin 13 (GND) |
| Normal Operating temperature | -40 °C to +65 °C |

Table 2: EVK-M8U specifications

2.1 Safety precautions

EVK-M8U must be supplied by an external limited power source in compliance with clause 2.5 of the standard IEC 60950-1. In addition to an external limited power source, only separated or Safety Extra-Low Voltage (SELV) circuits are to be connected to the evaluation kit, including interfaces and antennas.

 For more information about SELV circuits, see section 2.2 in the IEC 60950-1 [5] safety standard.

 **CAUTION!** IN THE UNLIKELY EVENT OF A FAILURE IN THE INTERNAL PROTECTION CIRCUITRY THERE IS A RISK OF AN EXPLOSION WHEN CHARGING FULLY OR PARTIALLY DISCHARGED BATTERIES. REPLACE THE BATTERY IF IT NO LONGER HAS SUFFICIENT CHARGE FOR UNIT OPERATION. CHECK THE BATTERY BEFORE USING IF THE DEVICE HAS NOT BEEN OPERATED FOR AN EXTENDED PERIOD OF TIME.

3 Device description

3.1 Interface connection and measurement

For connecting the EVK to a PC, use a standard SUBD-9 cable and the included USB cable. The use of RS232 and external power supply is optional. USB provides both power and a communications channel.

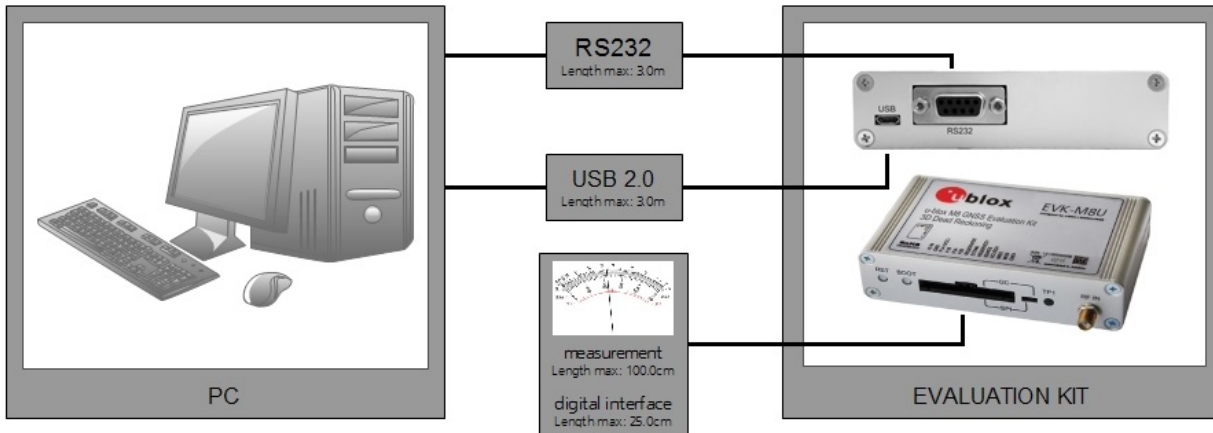

Figure 1: Connecting the unit for power supply and communication

3.2 Active antenna

The EVK-M8U evaluation kit includes a GPS / GLONASS / BeiDou antenna with a 3 m cable. It is possible to connect various active and passive GNSS antennas to the evaluation unit with SMA connectors.

The recommended maximum antenna supply current for active antennas is 30 mA.

3.3 Evaluation unit

Figure 2 shows the front and the rear panel of the EVK-M8U evaluation unit.



Figure 2: EVK-M8U evaluation unit – front and rear panels

3.3.1 Antenna connector

An SMA female jack is available on the front side (see Figure 2) of the evaluation unit for connecting an active or passive antenna. The EVK provides a DC supply at the RF input of 3.3 V for active antennas. The maximum supported antenna current is 30 mA; internal protection limits the maximum short circuit current to 60 mA.

To avoid the damage of RF input caused by ESD or electrical overstress, and to seek maximum consistency and repeatability of performance independently of the RF component used, the EVK-M8U has an onboard LNA.

- The connector is only to be used with a GNSS antenna or simulator. Do not connect this equipment to cable distribution systems.

3.3.2 USB

A USB V2.0 compatible serial port is featured for data communication and power supply.

3.3.3 UART

The evaluation unit includes an RS232 DCE port for serial communication that is compatible with PC serial ports.

Connect using a straight RS232 serial cable with male and female connectors to the DTE port on your PC. The maximum cable length is 3.0 meters. To configure the RS232 port, use the CFG-PRT command in the u-center application. The maximum operating baud rate is 921.6 kBd.

If you are using a USB to RS232 adaptor cable, you can connect it directly to the evaluation kit's RS232 port.

The 9-pin D-SUB female connector is assigned as listed in Table 3:

| Pin No. | Assignment |
|---------|--|
| 1 | not connected |
| 2 | TXD, GNSS Transmit Data, serial data to DTE |
| 3 | RXD, GNSS Receive Data, serial data from DTE |
| 4 | not connected |
| 5 | GND |
| 6 | not connected |
| 7-9 | not connected |

Table 3: SUB-D9 connector pin descriptions for the EVK-M8U

3.3.4 RST button

The RST button on the front panel resets the unit. To avoid an inadvertent reset, the button is recessed.

3.3.5 Safe boot button

This is used to set the unit in safe boot mode. In this mode, the receiver executes only the minimal functionality, such as updating new firmware into the SQI flash. In order to set the receiver in safe boot mode, follow these steps.

- Press the BOOT button and keep holding it down
- Press the RST button
- First release the RST button
- Then release the BOOT button
- If the UART interface needs to be used, the training sequence must be sent to the receiver. The training sequence is a transmission of two bytes 0x55 55 at the baud rate of 9600 Bd. You must wait for at least 100 milliseconds before the interface is ready to accept commands.

3.3.6 Slide Switch

Use the slide switch on the front panel to choose between the I²C (and UART) and SPI communication ports. You will need to reset the unit by pressing the RST button when the slide switch has been changed.

1. I²C: With this selection, the EVK operates with the UART (RS232 DB9 – rear panel or the 3.3 V level TxD (MISO), RxD (MOSI) at the front panel). Also the communication via 3.3 V DDC interface (I²C) is selected.
2. SPI: With this selection, the EVK operates only with the SPI interface. The RS232 (DB9) is switched off.

 For more information about specification and usage of SPI interface, see the *NEO-M8U Data Sheet* [1] and the *NEO-M8U Hardware Integration Manual* [2].

3.3.7 Front test connector

This 14-pin connector provides access to additional functionality to the EVK via various interface pins. The connector also enables measurement of the current used by the EVK. For accurate measurements, it is recommended to use a cable of at most 1 meter in length.

When connecting the 3.3 V digital interfaces, SPI and DDC to your application, a cable length less than 25 cm is recommended.

We recommend using the ACE-AM-0 mating connector or equivalent. The ACE-AM-0, which has ESD-protected pins, is available at our online shop:

<https://shop-emea.u-blox.com/en/eur/3~330~EMEA/Evaluation-kits-tools/Accessories/Cables-books>.

| Pin No. | Pin name | I/O | Level | Description |
|---------|------------|-----|-----------------|---|
| 14 | V5_IN | I | 4.75 V – 5.25 V | Power input – can be used instead of USB |
| 13 | GND | I | - | Common ground pin for case-work, power and serial interface connections |
| 12 | P1A (VCC) | O | 3.3 V | Regulated power output/monitor – max. current supply 100 mA 1Ω 1% resistor for over-all current measurement to pin 11 (P1B) <i>NOTE: this supply powers the active antenna, additional LNA, LED and UART interface buffers directly</i> |
| 11 | P1B | O | | Second connection for module current measurement (see Figure 18) |
| 10 | P2A | O | 3.0 V | Battery output (unloaded) 100 Ω 1% resistor for battery backup current measurement to pin 9 (P2B) <i>NOTE: There is a current protection to 3 mA. See circuit in Figure 21 (D2, D4, R29)</i> |
| 9 | P2B | O | | Second junction for battery backup current measurement |
| 8 | RESERVED0 | - | - | Not connected |
| 7 | EXTIN0 | I | 3.3 V | External interrupt input |
| 6 | RESERVED1 | - | - | Not connected |
| 5 | SDA / CS | I/O | 3.3 V | If slide switch on I2C, then the DDC interface is selected; Function: data input / output If slide switch on SPI, then the SPI interface is selected; chip select input – LOW ACTIVE |
| 4 | SCL / SCK | I/O | 3.3 V | Clock input / output |
| 3 | TxD / MISO | I/O | 3.3 V | If slide switch on I2C, then the DDC interface is selected / UART TxD (3.3V Level) If slide switch on SPI, then the SPI interface is selected; Master in Slave out (MISO) |
| 2 | RxD / MOSI | I/O | 3.3 V | If slide switch on I2C, then the DDC interface is selected / UART RxD (3.3V Level) If slide switch on SPI, then the SPI interface is selected; Master out Slave in (MOSI) |
| 1 | GND | I | - | Common ground pin |

Table 4: Connector pin descriptions for the EVK-M8U (pins numbered from right to left on the front panel)

 THE EVK CASE-WORK IS CONNECTED TO THE COMMON SUPPLY/INTERFACE GROUND PIN (PIN 13). Contact u-blox technical support for assistance if required.

3.3.8 LED

On the front panel of the unit, a single blue LED may be configured to follow the receiver time pulse signal using the UBX-CFG-TP5 message. The time pulse may be configured so that the LED starts flashing at one pulse per second during a valid GNSS fix. If there is no GNSS fix, the LED will only light, without flashing. The time pulse is enabled by default in the EVK-M8U.

3.3.9 Backup battery

There is a backup battery in the evaluation unit. This is necessary to store calibration and navigation information between operations and to enable immediate start-up in DR mode and fast acquisition of GNSS signals. It is a RENATA 3.0 V Li / MnO₂ battery of the type CR2450. The battery has a rated capacity of 540 mAh. The battery operating temperature range is -40 °C to +85 °C.

In case the built-in backup battery runs low or empty after a long storage period, purchase the above describe battery for replacement (refer to section 10 for battery replacement guidelines).

 CAUTION! RISK OF EXPLOSION IF BATTERY IS REPLACED BY AN INCORRECT TYPE. DISPOSE OF USED BATTERIES ACCORDING TO THE INSTRUCTIONS!

3.3.10 GNSS configuration

The EVK-M8U supports GPS, Galileo, QZSS, GLONASS, and BeiDou.

The GNSS to be used can be configured on u-center (View → Messages View then UBX-CFG-GNSS). For more information, refer to the *u-center User Guide* [4], and the *u-blox 8/M8 Receiver Description including Protocol Specification* [3].

4 Setting up

4.1 EVK-M8U installation

The EVK-M8U ships with an active GPS / GLONASS / BeiDou magnetic mount antenna with a 3 m cable.



The following sections describe the steps required to complete the EVK-M8U hardware installation.

4.1.1 Mounting the GNSS antenna

Attach the antenna to the car; for best performance attach it on the roof as shown in Figure 3. Bring the antenna cable in through the window or door. Be careful not to damage the antenna cable.

4.1.2 Mounting the EVK-M8U

The EVK-M8U should be firmly attached to the car body so as to avoid any movement or vibration with respect to the car body. The EVK should not be attached to any 'live' (unsprung) part of the vehicle's suspension. Often it is enough to use strong double sided tape or Velcro tape glued to the bottom of the EVK-M8U casing. If necessary, mounting brackets may be attached using the end-plate retaining bolts (M3). The EVK must be secured against any change in position and particularly its orientation with respect to the vehicle frame.

-  The EVK case-work, antenna and USB connectors are linked internally to the common supply/interface ground (pin 13).
-  Dead-reckoning performance will be seriously impaired by errors or changes in the orientation of the EVK.

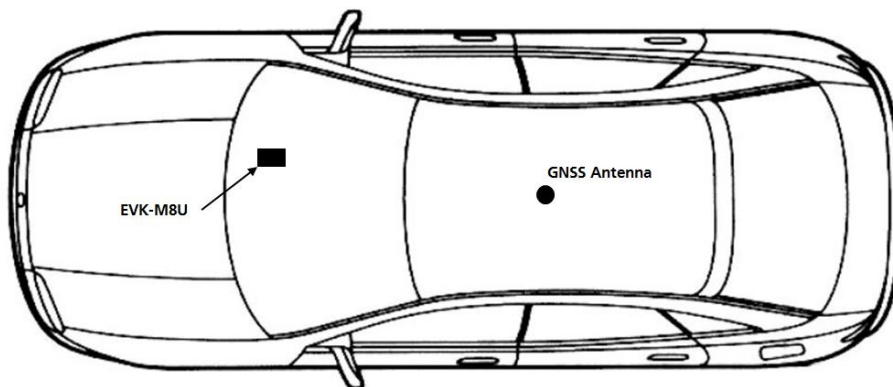

Figure 33: Example installation of the GNSS antenna and the EVK-M8U

4.1.3 Connecting the cables

Unless using USB alone, we recommend using the ACE-AM-0 mating connector (available from the u-blox online shop) because it locks securely to the front test connector. You will need to solder the necessary I/O cables to signal sources and outputs as specified in Table 5.

1. Connect the finalized cable to the front connector of EVK-M8U.
2. Connect the unit to a PC running Microsoft Windows by
 - 2.1. USB: Connect via USB port or
 - 2.2. UART: Connect via RS232. Set the slide switch to I2C or
 - 2.3. SPI/I²C compliant DDC: Connect corresponding pins (see Table 4 for pin description). Set the slide switch accordingly to SPI or I²C.
3. Press the RST button after changing the SPI/I²C switch.
4. The device may be powered either via USB or from a 5 V supply via the V5_IN input on the front.
5. Connect the RF cable of the GNSS antenna to the RF_IN connector.
6. Start the u-center GNSS Evaluation Software and select the corresponding COM port and baud rate.
7. Refer to the *u-center User Guide* [4] for more information.

4.2 Recommended configuration

For optimum navigation performance, the recommended navigation rate configuration is as follows:

The default DR/GNSS-fused navigation solution update rate of 1 Hz is recommended. You can set the navigation update rate with the message UBX-CFG-RATE. (In this mode, navigation rates up to 30 Hz are also available from the UBX-HNR-PVT message.)

4.2.1 Serial port default configuration

| Parameter | Description | Remark |
|---------------------|----------------------------------|----------------------------------|
| UART Port 1, Input | UBX and NMEA protocol at 9600 Bd | |
| UART Port 1, Output | UBX and NMEA protocol at 9600 Bd | Only NMEA messages are activated |
| USB, Input | UBX and NMEA protocol | |
| USB, Output | UBX and NMEA protocol | Only NMEA messages are activated |

Table 5: Default configuration

4.2.2 UDR receiver operation

By default, the EVK-M8U is ready to operate in UDR navigation mode.

 The statuses of different modes of the UDR receiver are output in the UBX-ESF-STATUS message.

4.2.2.1 Initialization mode

The purpose of the Initialization phase is to estimate all unknown parameters which are required for achieving fusion. In this case, the required sensor calibration status shows NOT CALIBRATED (see Figure 4). Note that the initialization phase requires good GNSS signals conditions as well as periods during which the vehicle is stationary and when it is moving (including turns). Once all of the required initialization steps are achieved, fusion mode is triggered and the calibration phase begins.

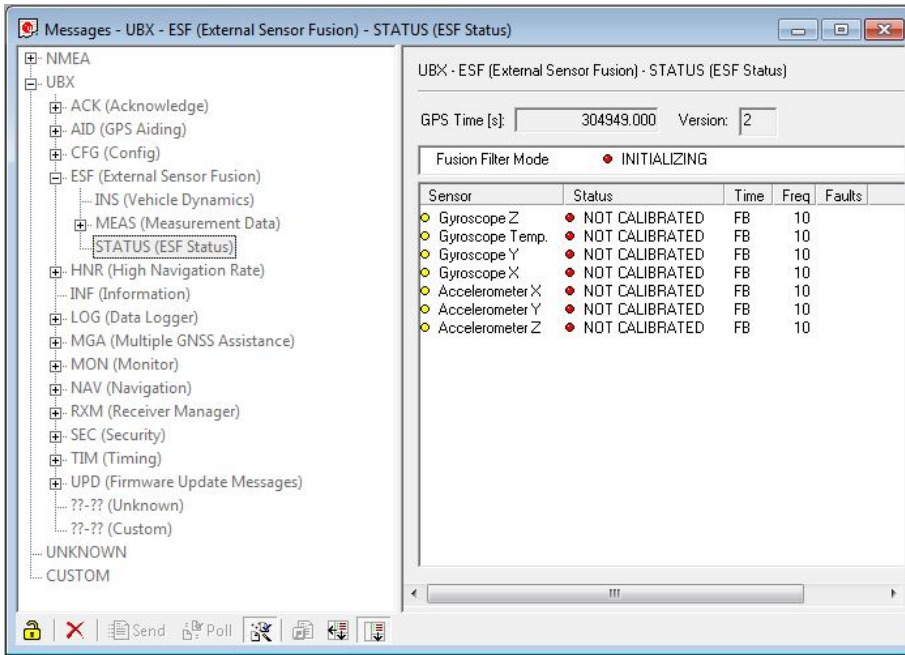

Figure 4: Screenshot of u-center showing the INITIALIZING mode in UBX-ESF-STATUS message

4.2.2.2 Fusion mode

Once the initialization phase is achieved, the receiver enters navigation mode and starts to compute combined GNSS/Dead-reckoning fixes and to calibrate the sensor required for computing the fused navigation solution. The sensor calibration status outputs CALIBRATING (see Figure 5).

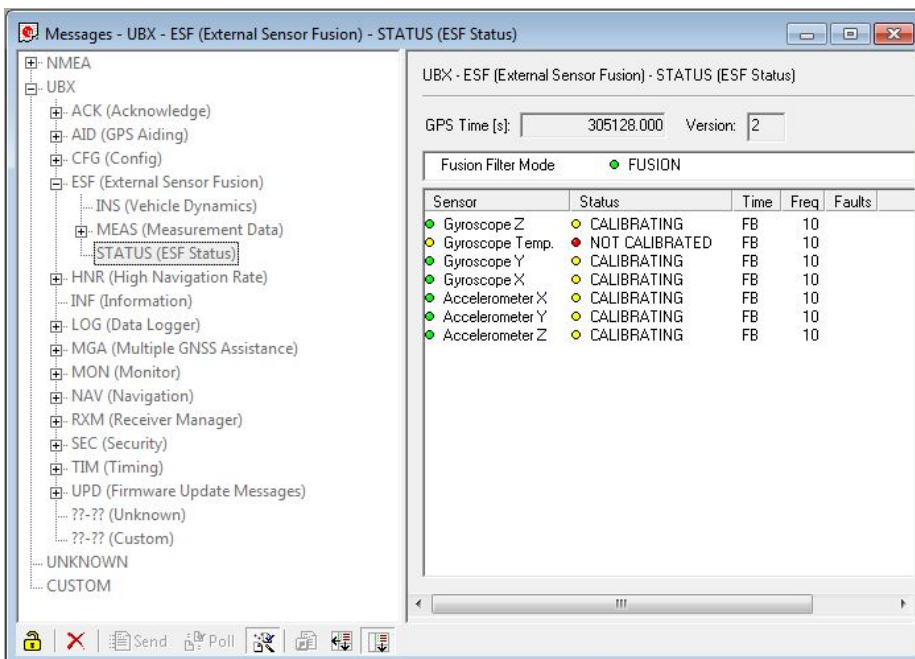

Figure 5: Screenshot of u-center showing the FUSION mode in UBX-ESF-STATUS message

As soon as the calibration has reached a status where optimal fusion performance can be expected, the sensor calibration status are flagged as CALIBRATED (see Figure 6).

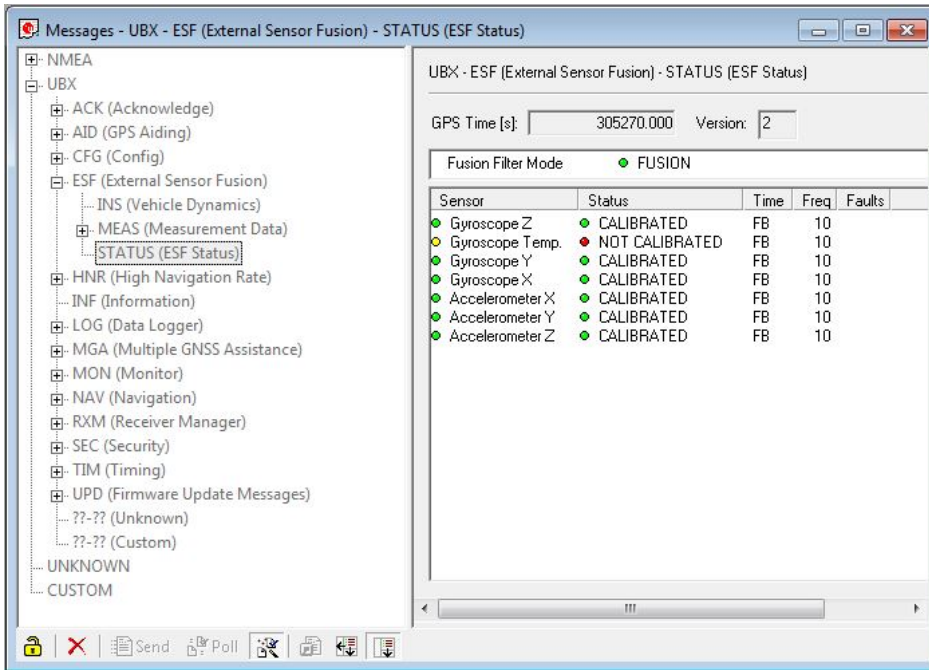



Figure 6: Screenshot of the u-center application showing the sensor calibration status as CALIBRATED

4.3 Accelerated initialization and calibration procedure

This section describes how to perform fast initialization and calibration of the UDR receiver for the purpose of evaluation.

The duration of the initialization phase mostly depends on the quality of the GNSS signals and the dynamics encountered by the vehicle. An open and flat area, such as an empty open-sky parking area, provides suitable good conditions. The initialization and calibration drive should contain phases where the car is stopped for a few minutes (with the engine running), phases where the car is making ordinary left and right turns, and phases where its speed is above 30 km/h under good GNSS reception conditions.

-  Note that the calibration status of some used sensors might fall back to CALIBRATING if the receiver is operated in challenging conditions. In such a case, fused navigation solution uncertainty increases until optimal conditions are observed again for re-calibrating the sensors.
-  For more information, see the *u-blox 8 / M8 Receiver Description including Protocol Specification* [3].

5 Test drives

Before testing can be done, make sure that the initialization and calibration have been completed according to chapter 4.

We recommend recording and archiving the data of your test drives. You can enable additional debug messages by clicking the Debug button, and then clicking the Record button (see Figure 7). When prompted to poll for configuration, click “Yes” (see Figure 8).

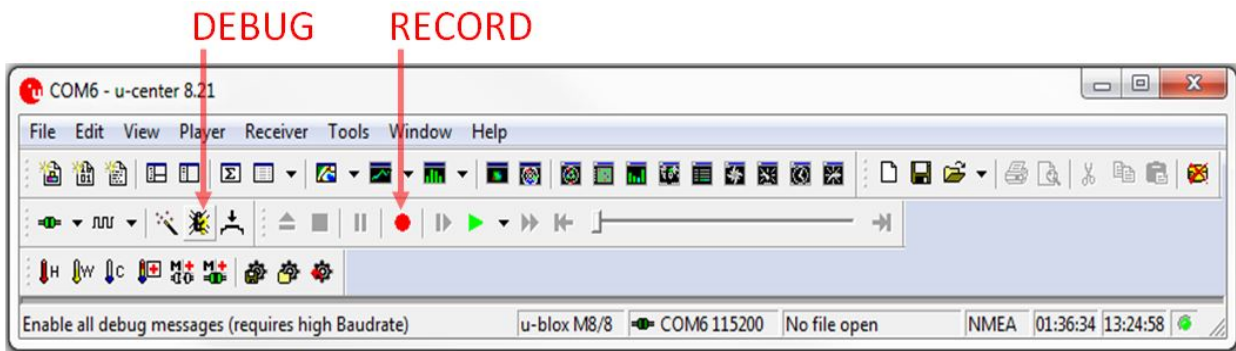

Figure 7: The Debug and Record buttons are used for extra messages and debugging / post-analysis

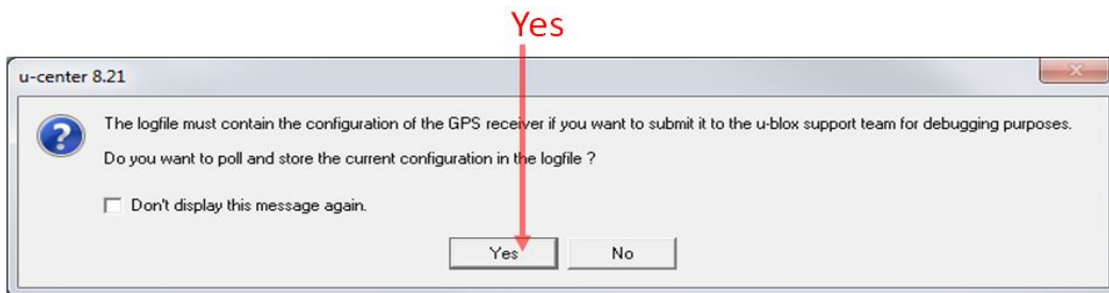



Figure 8: Allow polling and storing of the receiver configuration into a log file

6 Measuring tracking current

To measure the NEO-M8U module tracking current with the EVK-M8U, follow these steps:

1. Connect a mean reading voltmeter across P1A (VCC) and P1B of the front connector (see Figure 9).
2. Wait 12 minutes to download all of the GNSS orbital data, or download all the Aiding Data via the AssistNow Online service.
3. Read the voltage (and average if necessary) on the voltmeter and convert to current (1 mV corresponds to 1 mA).
4. Perform the test with good signals and clear sky views to ensure that the receiver can acquire the satellite signals.

 The NEO-M8U module current measurement includes its internal SQI flash, inertial sensor, and any current delivered to SPI or I²C interface loads.

For more details, see the circuit in Figure 12.

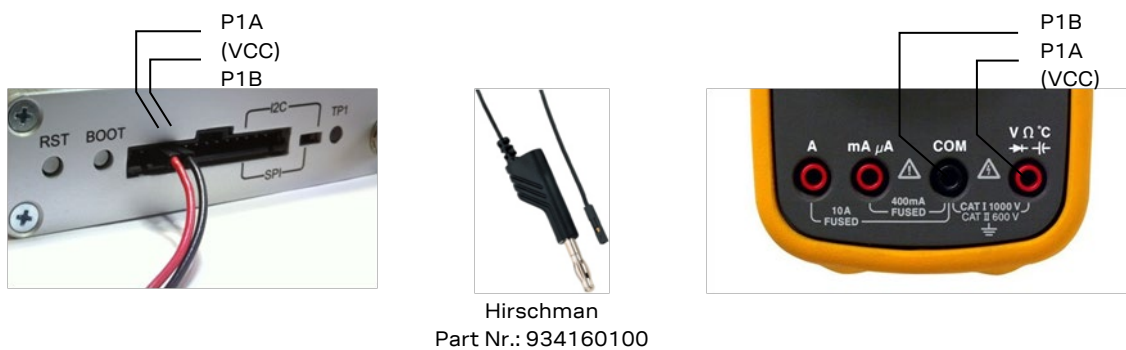

Figure 9: Example – tracking current measurement

7 Block diagram

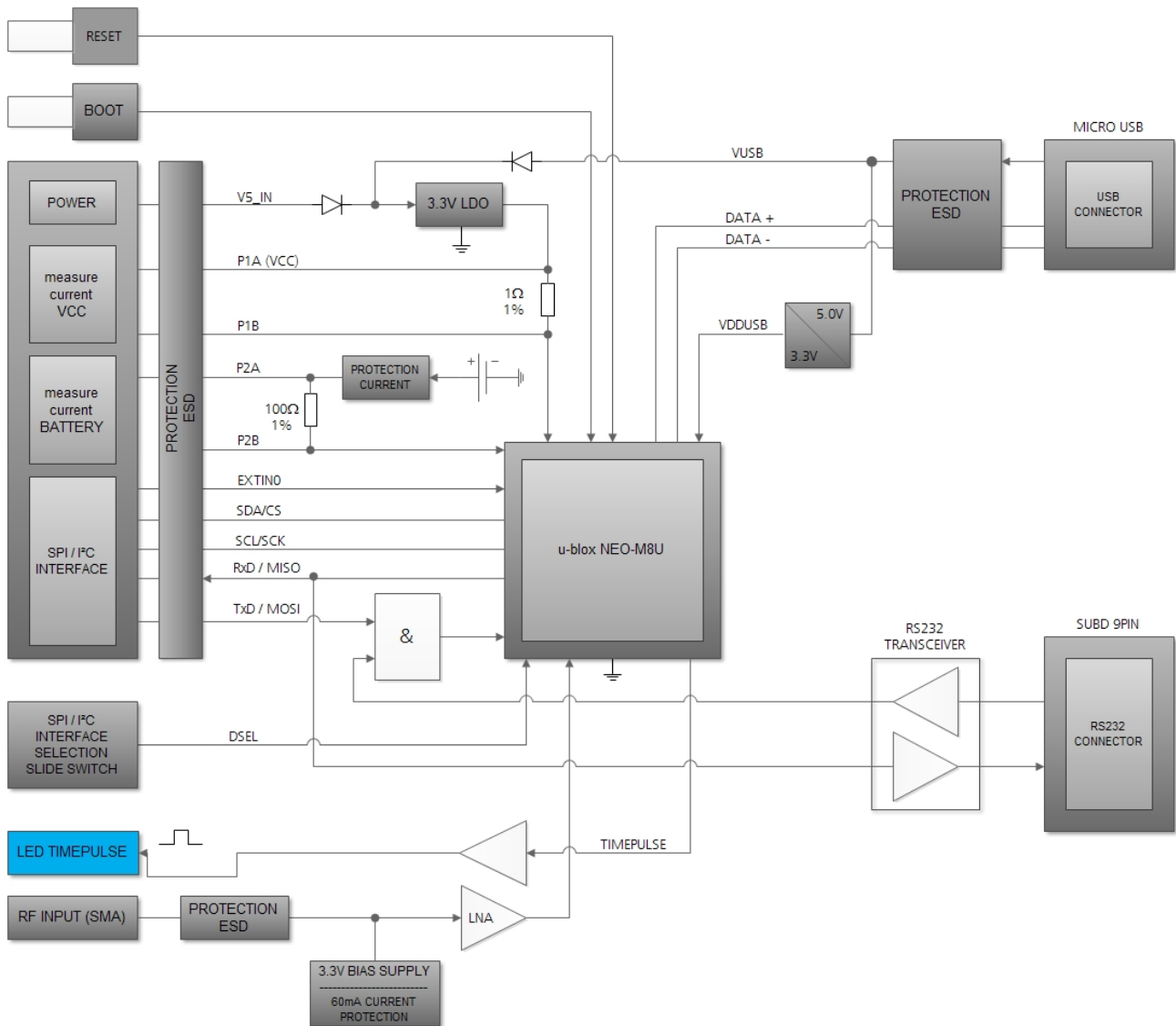

Figure 10: EVK-M8U block diagram

| PART | DESCRIPTION |
|-----------------------------|---|
| A1 | GNSS RECEIVER -40/+85C |
| BT1 | BATTERY HOLDER RENATA CR2450N 3V |
| C1 C11 C13 C22 | CAP CER X5R 0603 1U0 10% 6.3V |
| C10 C14 C16 C19 C2 C6 C7 C8 | CAP CER X7R 0603 100N 10% 10V |
| C12 C9 | CAP CER X7R 0603 10N 10% 25V |
| C20 | CAP CER COG 0402 1P8 +/-0.1P 25V |
| C21 | CAP CER COG 0402 22P 5% 25V |
| C23 | CAP CER COG 0402 47P 5% 25V |
| C24 | CAP CER X5R 0402 100N 10% 10V |
| C25 C3 | CAP CER X5R 1210 10U 10% 10V |
| C4 | CAP CER X7R 0603 1N0 10% 25V |
| C5 | CAP CER X7R 0402 1N0 10% 16V |
| D1 D2 D4 D5 | SURFACE MOUNT SCHOTTKY BARRIER RECTIFIER SS14 1A -55/+125C |
| D3 R18 R20 R21 R22 R23 | ESD PROTECTION FOR HIGH SPEED LINES, TYCO, 0.25PF, PESD0402-140 -55/+125C |
| DS1 | LED OSRAM HYPER MINI TOPLED LB M673-L1N2-35 BLUE 0.02A |
| FB1 | FERRITE BEAD MURATA BLM15HD 0402 1000R@100MHZ |
| J1 | CON USB RECEPTACLE MICRO B TYPE SMD – MOLEX 47346-0001 – TID60001597 30V 1A |
| J2 | CON SMA SMD STRAIGHT JACK 11.4MM HEIGHT WITHOUT WASHER AND NUT |
| J3 | 9 POLE SUBD CONNECTOR FEMALE |
| J4 | 14PIN 90° 2.54MM PITCH DISCONNECTABLE CRIMP CONNECTOR -40/+85C |
| L1 | IND MURATA LQW15A 0402 8N7 3% 0.54A -55/+125C |
| L2 | IND MURATA LQW15A 0402 120N 5% 0.64A -55/+125C |
| Q1 | MBT3906DW1T1G DUAL GENERAL PURPOSE TRANSISTOR 0.2A 0.15W -40/+125C |
| R1 | RES THICK FILM CHIP 1206 10R 5% 0.25W |
| R10 | RES THICK FILM CHIP 0402 220R 5% 0.1W |
| R11 R2 R6 | RES THICK FILM CHIP 0603 100R 5% 0.1W |
| R12 | RES THICK FILM CHIP 0402 2K2 5% 0.1W |
| R13 R24 R27 | RES THICK FILM CHIP 0603 100K 5% 0.1W |
| R14 R15 R19 R3 R8 | VARISTOR BOURNS MLE SERIES CG0402MLE-18G 18V |
| R29 | RES THICK FILM CHIP 0603 1K0 5% 0.1W |
| R47 R48 R49 R50 | RES THICK FILM CHIP 0402 0R 0 0.1W |
| R4 R5 | RES THICK FILM CHIP 0603 22R 5% 0.1W -55/+125C |
| R7 | RES THICK FILM CHIP 0603 1R0 5% 0.1W |
| S1 S2 | SWITCH SPST ON 1POL TYCO -40/+85C |
| S3 | 2 WAY SUB-MINIATURE SLIDE SWITCH SMD JS SERIES – SPDT -40/+85C |
| U1 | USB DATA LINE PROTECTION ST USBLC6-2SC6 SOT23-6 |
| U2 U4 | LOW DROPOUT REGULATOR LINEAR LT1962 MS8 3.3V 0.3A |
| U3 U9 | TINY LOGIC UHS BUFFER OE_N ACTIVE LOW FAIRCHILD NC7SZ125 SC70 |
| U5 | LOW NOISE AMPLIFIER GAAS MMIC 1.575 GHZ 1.5V-3.6V JRC EPFFP6-A2 3.6V -40/+85C |
| U6 | RS-232 TRANSCEIVER 1MBIT 3-5,5VOLT TRSF3223 – VQFN20 5.5V -40/+85C |
| U7 | TINY LOGIC ULP-A 2-INPUT AND GATE 1.45X1.0 6-LEAD MICROPAC -40/+85C |

Table 6: EVK-M8U component list

9 Schematic

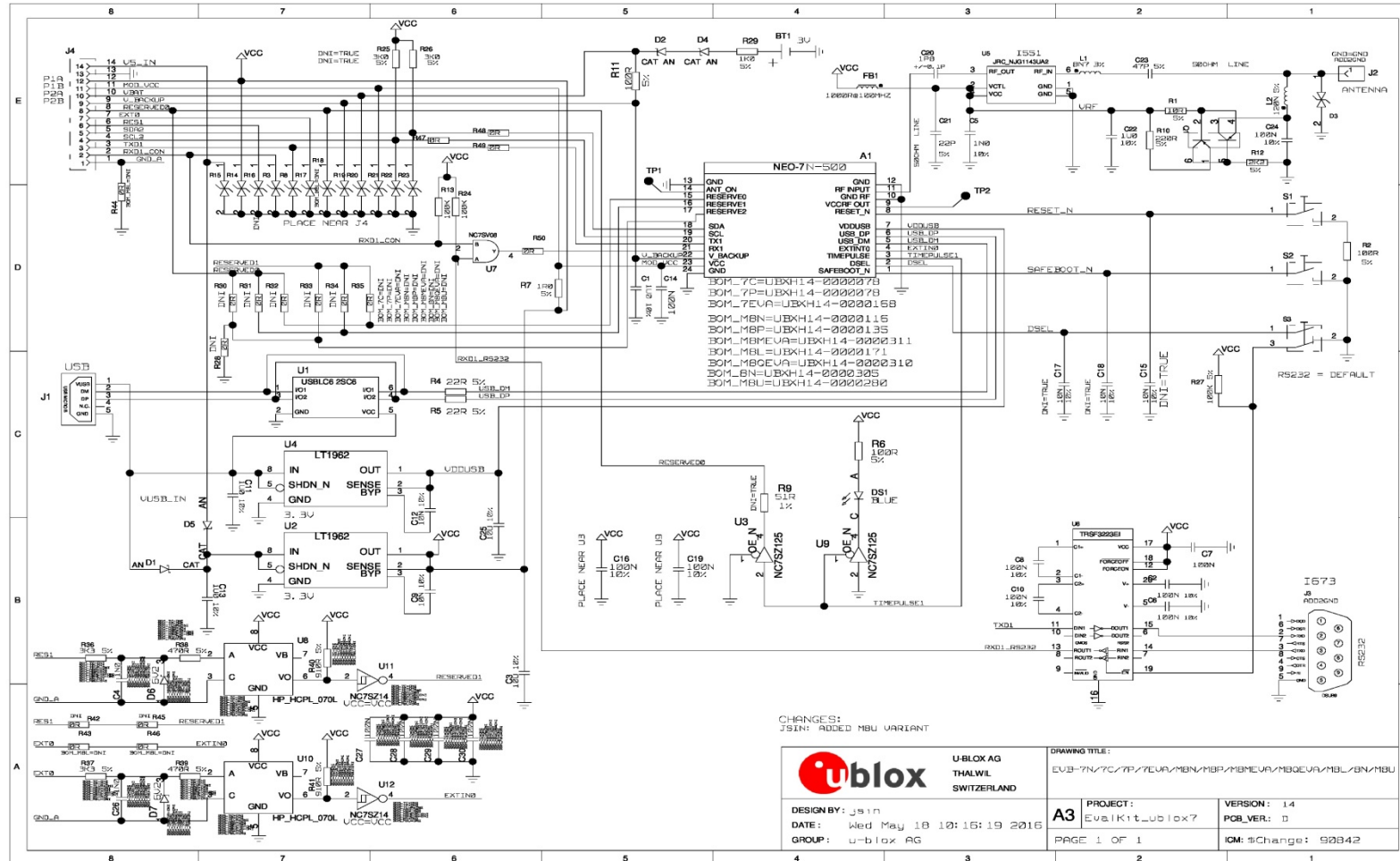

Figure 12: Schematic EVK-M8U: DNI=TRUE in the schematic means: Component not installed

10 Battery replacement

To replace the battery (indicated as component 5 in Figure 13), open the unit (unscrew the four screws on the front panel).

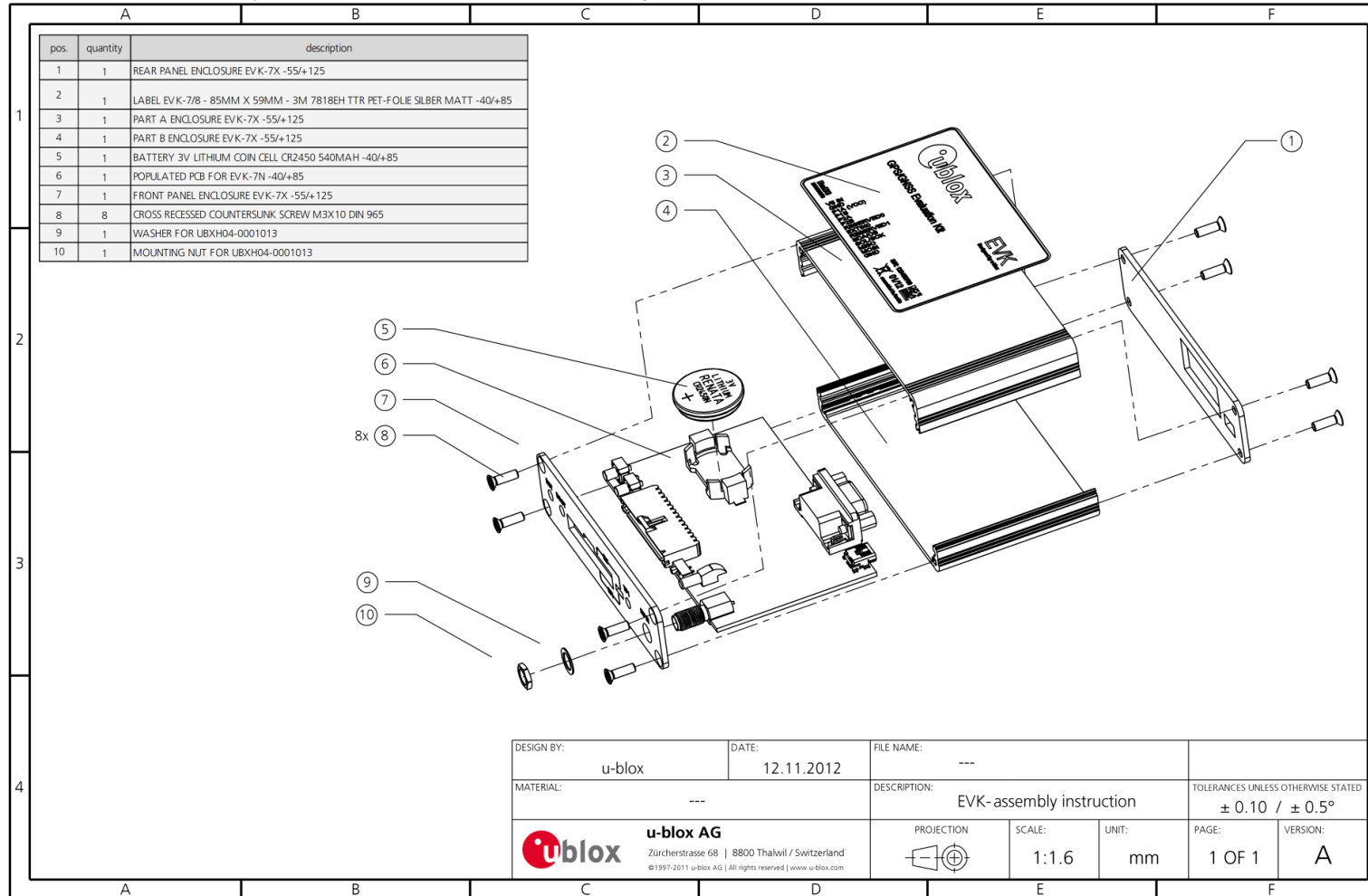

Figure 13: EVK-M8U battery location

11 Troubleshooting

My application (e.g. u-center) does not receive anything

Make sure that the USB cable is properly connected to the evaluation unit and the PC and USB drivers are installed correctly. By default, the evaluation unit outputs NMEA protocol on Serial Port 1 at 9600 Bd and on the USB.

My application (e.g. u-center) does not receive all messages

When using UART, make sure the baud rate is sufficient. If the baud rate is insufficient, GNSS receivers based on u-blox M8 GNSS technology will skip excessive messages. Some serial port cards/adapters (i.e. USB to RS232 converter) frequently generate errors. If a communication error occurs while u-center receives a message, the message will be discarded.

My application (e.g. u-center) loses the connection to the GNSS receiver

The u-blox M8 positioning technology and u-center have an autobauding feature. If frequent communication errors occur (e.g. due to problems with the serial port), the connection may be lost. This happens because u-center and the GNSS receiver both autonomously try to adjust the baud rate. Do not enable the u-center autobauding feature if the GNSS receiver has the autobauding flag enabled.

The COM port does not send any messages

Be sure that the slide switch at the front panel is set to I2C and not SPI. In SPI modem the RS232 pins on the DB9 connector are switched off and the Rx/D and Tx/D output at the front panel are used for SPI (MISO, MOSI).

 After changing the slide switch, always reset the EVK, otherwise the change will not take effect.

Some COM ports are not shown in the port list of my application (e.g. u-center)

Only the COM ports that are available on your computer will show up in the COM port drop down list. If a COM port is gray, another application running on this computer is using it.

The position is inaccurate by a few dozen meters

The u-blox M8 GNSS technology starts up with the WGS84 standard GNSS datum. If your application expects a different datum, you'll most likely find the positions to be off by a few dozen meters. Don't forget to check the calibration of the u-center map files.

The position is inaccurate by hundreds of meters

Position drift may also occur when almanac navigation is enabled. The satellite orbit information retrieved from an almanac is much less accurate than the information retrieved from the ephemeris. With an almanac-only solution, the position will only have an accuracy of a few kilometers but it may start up faster or still navigate in areas with obscured visibility when the ephemeris from one or several satellites have not yet been received. The almanac information is NOT used for calculating a position if valid ephemeris information is available, regardless of the setting of this flag.

In the NMEA protocol, position solutions with high deviation (e.g. due to enabling almanac navigation) can be filtered with the Position Accuracy Mask. The UBX protocol does not directly support this since it provides a position accuracy estimation, which allows the user to filter the position according to his requirements. However, the "Position within Limits" flag of the UBX-NAV-STATUS message indicates if the configured thresholds (i.e. P Accuracy Mask and PDOP) are exceeded.

TTFB times at start-up are much longer than specified

At start-up (after the first position fix), the GNSS receiver performs an RTC calibration to have an accurate internal time source. A calibrated RTC is required to achieve the minimal start-up time.

Before shutting down the receiver externally, check the status in MON-HW in the field “Real Time Clock Status”. Do not shut down the receiver if the RTC is not calibrated.

The EVK-M8U does not meet the TTFF specification

Make sure the antenna has a good sky view. An obstructed view leads to prolonged start-up times. In a well-designed system, the average of the C/No ratio of high elevation satellites should be in the range from 40 dBHz to about 50 dBHz. With a standard off-the-shelf active antenna, 47 dBHz should easily be achieved. Low C/No values will lead to prolonged start-up times.

The EVK-M8U does not preserve the configuration in case of reset

The u-blox M8 GNSS technology uses a slightly different concept than most other GNSS receivers do. Settings are initially stored to volatile memory. In order to save them permanently, it is necessary to send a second command. This allows for testing new settings and being able to revert to the old settings by resetting the receiver if the new settings aren't good. This provides safety, as it is no longer possible to accidentally program a bad configuration (e.g. disabling the main communication port).

The EVK-M8U does not work properly when connected with a GNSS simulator

When using an EVK together with a GNSS simulator, pay attention to correct handling of the EVK. A GNSS receiver is designed for real-life use, i.e. time is always moving forward. By using a GNSS simulator, the user can change scenarios, which enables jumping backwards in time. This can have serious side effects on the performance of GNSS receivers.

Solve this by configuring the GPS week roll-over to 1200 (as shown in Figure 14), which corresponds to Jan 2003. Then issue the Cold Start command before every simulator test to avoid receiver confusion due to time jumps.

12 Common evaluation pitfalls

- A parameter may have the same name but a different definition. GNSS receivers may have a similar size, price and power consumption, but can still have different functionalities (e.g. no support for passive antennas, different temperature operating ranges). Also, the definitions of hot, warm, and cold start times may differ between suppliers.
- Verify design-critical parameters; do not base a decision on unconfirmed numbers from datasheets.
- Try to use identical or at least similar settings when comparing the GNSS performance of different receivers.
- Data which have not been recorded at the same time and the same place should not be compared. The satellite constellation, the number of visible satellites and the sky view might have been different.
- Do not compare momentary measurements. GNSS is a non-deterministic system. The satellite constellation changes constantly. Atmospheric effects (i.e. dawn and dusk) have an impact on signal travel time. The position of the GNSS receiver is typically not the same between two tests. Comparative tests should therefore be conducted in parallel by using one antenna and a signal splitter; statistical tests shall be run for 24 hours.
- Monitor the Carrier-To-Noise-Ratio. The average C/No ratio of the high elevation satellites should be between 40 dBHz and about 50 dBHz. A low C/No ratio will result in a prolonged TTFF and more position drift.
- When comparing receivers side by side, make sure that all receivers have the same signal levels. The best way to achieve this is by using a signal splitter. Comparing results measured with different antenna types (with different sensitivities) may lead to incorrect conclusions.
- Try to feed the same signal to all receivers in parallel (i.e. through a splitter); the receivers won't have the same sky view otherwise. Even small differences can have an impact on their accuracy. One additional satellite can lead to a lower DOP and less position drift.
- When doing reacquisition tests, cover the antenna in order to block the sky view. Do not unplug the antenna since the u-blox M8 positioning technology continuously performs noise calibration on idle channels.

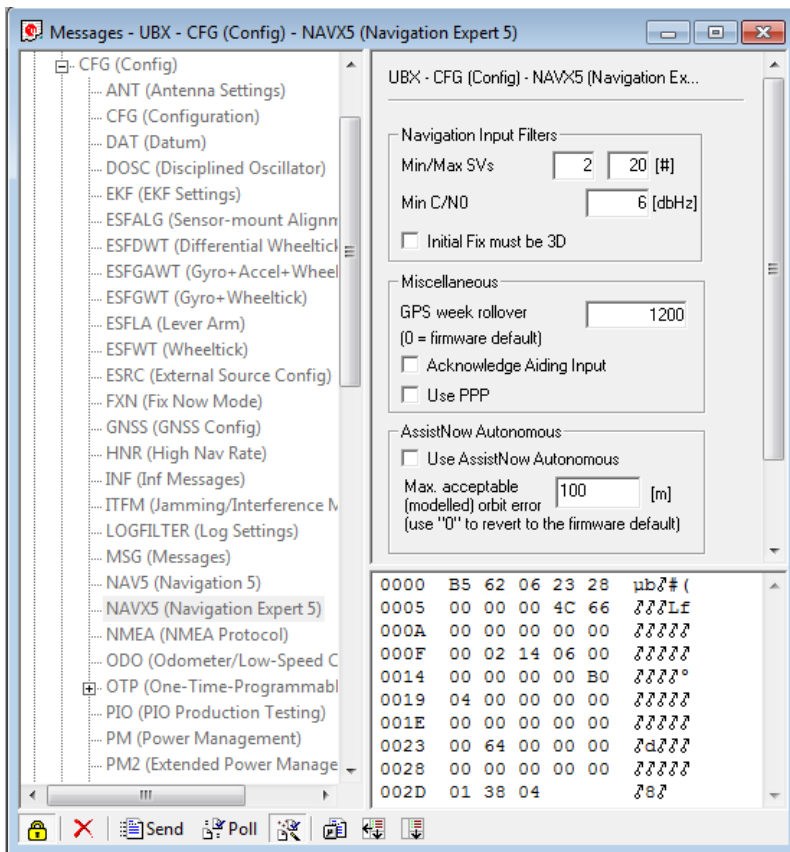

Figure 14: Configuration instruction for using the EVK with a GNSS simulator

Power Save Mode and USB

For communication in Power Save Mode, use the RS232.

EVK-M8U receives GPS and GLONASS

Use latest version of u-center. Message UBX-CFG-GNSS allows switching on and off the supported GNSS.

Related documents

- [1] NEO-M8U Data Sheet, Doc. No. UBX-15015679
- [2] NEO-M8U Hardware Integration Manual, Doc. No. UBX-15016700
- [3] u-blox 8 / M8 Receiver Description including Protocol Specification, Doc. No. UBX-13003221
- [4] u-center User Guide, Doc. No. UBX-13005250
- [5] Information technology equipment – Safety Standard IEC 60950-1
<https://webstore.iec.ch/publication/4024>

 For regular updates to u-blox documentation and to receive product change notifications, register on our homepage (www.u-blox.com).

Revision history

| Revision | Date | Name | Status / Comments |
|----------|--------------|------|--|
| R01 | 25-May-2016 | njaf | Advance information |
| R02 | 11-July-2016 | njaf | Early Product Information |
| R03 | 08-Jan-2018 | njaf | Added information on RED DoC in European Union regulatory compliance (page 2). Added section 2.1 (Safety Precautions). Removed extra backup battery from EVK content in section 1.2. |
| R04 | 20-Apr-2018 | ssid | Updated the firmware version to UDR 1.20 |
| R05 | 02-Nov-2018 | ssid | Updated the firmware version to UDR 1.21 |

Contact

For complete contact information, visit us at www.u-blox.com.

u-blox Offices

North, Central and South America

u-blox America, Inc.

Phone: +1 703 483 3180
E-mail: info_us@u-blox.com

Regional Office West Coast:

Phone: +1 408 573 3640
E-mail: info_us@u-blox.com

Technical Support:

Phone: +1 703 483 3185
E-mail: support@u-blox.com

Headquarters

Europe, Middle East, Africa

u-blox AG

Phone: +41 44 722 74 44
E-mail: info@u-blox.com
Support: support@u-blox.com

Documentation Feedback

E-mail: docsupport@u-blox.com

Asia, Australia, Pacific

u-blox Singapore Pte. Ltd.

Phone: +65 6734 3811
E-mail: info_ap@u-blox.com
Support: support_ap@u-blox.com

Regional Office Australia:

Phone: +61 2 8448 2016
E-mail: info_anz@u-blox.com
Support: support_ap@u-blox.com

Regional Office China (Beijing):

Phone: +86 10 68 133 545
E-mail: info_cn@u-blox.com
Support: support_cn@u-blox.com

Regional Office China (Chongqing):

Phone: +86 23 6815 1588
E-mail: info_cn@u-blox.com
Support: support_cn@u-blox.com

Regional Office China (Shanghai):

Phone: +86 21 6090 4832
E-mail: info_cn@u-blox.com
Support: support_cn@u-blox.com

Regional Office China (Shenzhen):

Phone: +86 755 8627 1083
E-mail: info_cn@u-blox.com
Support: support_cn@u-blox.com

Regional Office India:

Phone: +91 80 405 092 00
E-mail: info_in@u-blox.com
Support: support_in@u-blox.com

Regional Office Japan (Osaka):

Phone: +81 6 6941 3660
E-mail: info_jp@u-blox.com
Support: support_jp@u-blox.com

Regional Office Japan (Tokyo):

Phone: +81 3 5775 3850
E-mail: info_jp@u-blox.com
Support: support_jp@u-blox.com

Regional Office Korea:

Phone: +82 2 542 0861
E-mail: info_kr@u-blox.com
Support: support_kr@u-blox.com

Regional Office Taiwan:

Phone: +886 2 2657 1090
E-mail: info_tw@u-blox.com
Support: support_tw@u-blox.com