

## DS28E83

## DeepCover Radiation Resistant 1-Wire Authenticator

### General Description

The DS28E83 is a radiation-resistant secure authenticator that provides a core set of cryptographic tools derived from integrated asymmetric (ECC-P256) and symmetric (SHA-256) security functions. In addition to the security services provided by the hardware implemented crypto engines, the device integrates a FIPS-compatible true random number generator (TRNG), 10Kb of secured OTP, one configurable GPIO, and a unique 64-bit ROM identification number (ROM ID).

The ECC public/private key capabilities operate from the NIST defined P-256 curve and include FIPS 186-compliant ECDSA signature generation and verification to support a bidirectional asymmetric key authentication model. The SHA-256 secret key capabilities are compliant with FIPS 180 and are flexibly used either in conjunction with ECDSA operations or independently for multiple HMAC functions.

The GPIO pin can be operated under command control and include configurability supporting authenticated and nonauthenticated operation, including an ECDSA-based cryptorobust mode to support secure boot of a host processor.

DeepCover® embedded security solutions cloak sensitive data under multiple layers of advanced security to provide the most secure key storage possible. To protect against device-level security attacks, invasive and noninvasive countermeasures are implemented including active die shield, encrypted storage of keys, and algorithmic methods.

### Applications

- Medical Consumables Secure Authentication
- Medical Tools/Accessories Identification and Calibration
- Accessory and Peripheral Secure Authentication
- Secure Storage of Cryptographic Keys for Host Controllers
- Secure Boot or Download of Firmware and/or System Parameters

*DeepCover® is a registered trademark of Maxim Integrated Products, Inc.*

### Benefits and Features

- High Radiation Resistance Allows User-Programmable Manufacturing or Calibration Data Before Medical Sterilization
  - Resistant Up to 75kGy (kiloGray) of Radiation
  - One Time Programmable (OTP) 10kb of User Data, Keys, and Certificates
- ECC-P256 Compute Engine
  - FIPS 186 ECDSA P256 Signature and Verification
  - ECDH Key Exchange for Session Key Establishment
  - ECDSA Authenticated R/W of Configurable Memory
- SHA-256 Compute Engine
  - FIPS 180 MAC for Secure Download/Boot
  - FIPS 198 HMAC for Bidirectional Authentication and Optional GPIO Control
- SHA-256 OTP (One-Time Pad) Encrypted R/W of Configurable Memory Through ECDH Established Key
- One GPIO Pin with Optional Authentication Control
  - Open-Drain, 4mA/0.4V
  - Optional SHA-256 or ECDSA Authenticated On/Off and State Read
  - Optional ECDSA Certificate to Set On/Off After Multiblock Hash for Secure Download
- TRNG with NIST SP 800-90B Compliant Entropy Source with Function to Read Out
- Optional Chip Generated Pr/Pu Key Pairs for ECC Operations or Secrets for SHA256 Functions
- Unique and Unalterable Factory Programmed 64-Bit Identification Number (ROM ID)
  - Optional Input Data Component to Crypto and Key Operations
- Advanced 1-Wire Protocol Minimizes Interface to Just Single Contact
- Operating Range: 3.3V ±10%, 0°C to +50°C
- ±8kV HBM ESD Protection of 1-Wire IO Pin
- 6-Pin, 3mm x 3mm TDFN

[Ordering Information](#) appears at end of data sheet.

Simplified Block Diagram

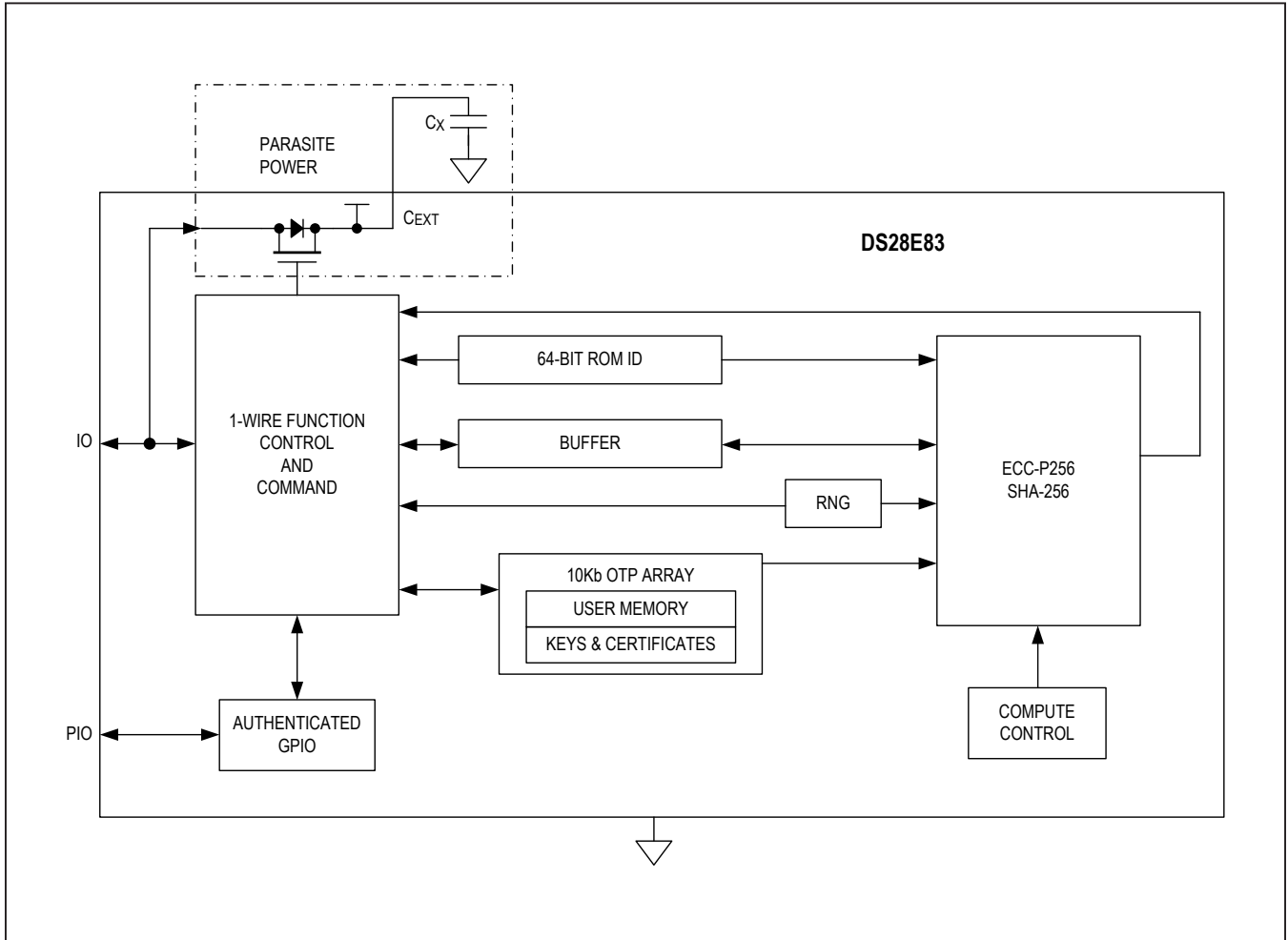

### Absolute Maximum Ratings

Voltage Range on Any Pin Relative to GND ..... -0.5V to 4.0V      Operating Temperature Range.....0°C to 50°C  
Maximum Current into Any Pin..... -20mA to +20mA      Lead Temperature (soldering, 10s) ..... +300°C

*Stresses beyond those listed under "Absolute Maximum Ratings" may cause permanent damage to the device. These are stress ratings only, and functional operation of the device at these or any other conditions beyond those indicated in the operational sections of the specifications is not implied. Exposure to absolute maximum rating conditions for extended periods may affect device reliability.*

### Package Information

#### 6 TDFN

Package Code	T633+2
Outline Number	<a href="#">21-0137</a>
Land Pattern Number	<a href="#">90-0058</a>
<b>Thermal Resistance, Single-Layer Board:</b>	
Junction to Ambient ( $\theta_{JA}$ )	55°C/W
Junction to Case ( $\theta_{JC}$ )	9°C/W
<b>Thermal Resistance, Four-Layer Board:</b>	
Junction to Ambient ( $\theta_{JA}$ )	42°C/W
Junction to Case ( $\theta_{JC}$ )	9°C/W

For the latest package outline information and land patterns (footprints), go to [www.maximintegrated.com/packages](http://www.maximintegrated.com/packages). Note that a "+", "#", or "-" in the package code indicates RoHS status only. Package drawings may show a different suffix character, but the drawing pertains to the package regardless of RoHS status.

Package thermal resistances were obtained using the method described in JEDEC specification JESD51-7, using a four-layer board. For detailed information on package thermal considerations, refer to [www.maximintegrated.com/thermal-tutorial](http://www.maximintegrated.com/thermal-tutorial).

### Electrical Characteristics

(Limits are 100% tested at  $T_A = +25^\circ\text{C}$ . Limits over the operating temperature range and relevant supply voltage range are guaranteed by design and characterization. Specifications marked GBD are guaranteed by design and not production tested. Specifications to the minimum and maximum operating temperature are guaranteed by design and are not production tested.)

PARAMETER	SYMBOL	CONDITIONS	MIN	TYP	MAX	UNITS
<b>IO PIN: GENERAL DATA</b>						
1-Wire Pullup Voltage	$V_{PUP}$	(Note 1)	2.97	3.3	3.63	V
1-Wire Pullup Resistance	$R_{PUP}$	(Notes 1, 2)			1000	$\Omega$
Input Capacitance	$C_{IO}$	(Note 3)		$0.1 + C_X$		nF
Capacitor External	$C_X$	(Note 1)	399.5	470	540.5	nF
Input Load Current	$I_L$	IO pin at $V_{PUP}$	Pre-radiation	40	360	$\mu\text{A}$
			Post-radiation	120		
High-to-Low Switching Threshold	$V_{TL}$	(Notes 4, 5, 6)		$0.65 \times V_{PUP}$		V
Input Low Voltage	$V_{IL}$	(Notes 4, 7)			$0.10 \times V_{PUP}$	V
Low-to-High Switching Threshold	$V_{TH}$	(Notes 4, 5, 8)		$0.75 \times V_{PUP}$		V
Switching Hysteresis	$V_{HY}$	(Notes 4, 5, 9)		0.3		V
Output Low Voltage	$V_{OL}$	$I_{OL} = 4\text{mA}$ (Note 10)			0.4	V

### Electrical Characteristics (continued)

(Limits are 100% tested at  $T_A = +25^\circ\text{C}$ . Limits over the operating temperature range and relevant supply voltage range are guaranteed by design and characterization. Specifications marked GBD are guaranteed by design and not production tested. Specifications to the minimum and maximum operating temperature are guaranteed by design and are not production tested.)

PARAMETER	SYMBOL	CONDITIONS	MIN	TYP	MAX	UNITS
<b>IO PIN: 1-Wire Interface</b>						
Recovery Time (Notes 1, 11, 12)	$t_{\text{REC}}$	Standard speed, Pre-radiation, $R_{\text{PUP}} = 1000\Omega$		25		$\mu\text{s}$
			Directly prior to reset pulse	100		
		Standard speed, Post-radiation, $R_{\text{PUP}} = 1000\Omega$ (Note 22)		50		
			Directly prior to reset pulse	1500		
Overdrive speed, $R_{\text{PUP}} = 1000\Omega$		10				
	Directly prior to reset pulse	100				
Rising-Edge Hold-off (Notes 4, 13)	$t_{\text{REH}}$	Applies to standard speed only		1		$\mu\text{s}$
Time Slot Duration (Notes 1, 14)	$t_{\text{SLOT}}$	Standard speed	Pre-radiation	85		$\mu\text{s}$
			Post-radiation (Note 22)	110		
		Overdrive speed		16		
<b>IO PIN: 1-Wire RESET, PRESENCE-DETECT CYCLE</b>						
Reset Low Time (Note 1)	$t_{\text{RSTL}}$	Standard speed	480		640	$\mu\text{s}$
		Overdrive speed	48		80	
Reset High Time (Note 1)	$t_{\text{RSTH}}$	Standard speed	480			$\mu\text{s}$
		Overdrive speed	48			
Presence Detect High Time	$t_{\text{PDH}}$	Standard speed	15		60	$\mu\text{s}$
		Overdrive speed	2		6	
Presence Detect Low Time	$t_{\text{PDL}}$	Standard speed	60		240	$\mu\text{s}$
		Overdrive speed	8		24	
Presence Detect Fall Time (Notes 4, 15)	$t_{\text{FPD}}$	Standard speed		1.25		$\mu\text{s}$
		Overdrive speed		0.15		
Presence-Detect Sample Time (Notes 1, 16)	$t_{\text{MSP}}$	Standard speed	65		75	$\mu\text{s}$
		Overdrive speed	7		10	
<b>IO PIN: 1-Wire WRITE</b>						
Write-Zero Low Time (Notes 1, 17)	$t_{\text{W0L}}$	Standard speed	60		120	$\mu\text{s}$
		Overdrive speed	6		15.5	
Write-One Low Time (Notes 1, 17)	$t_{\text{W1L}}$	Standard speed	0.25		15	$\mu\text{s}$
		Overdrive speed	0.25		2	
<b>IO PIN: 1-Wire READ</b>						
Read Low Time (Notes 1, 18)	$t_{\text{RL}}$	Standard speed	0.25		$15 - \delta$	$\mu\text{s}$
		Overdrive speed	0.25		$2 - \delta$	
Read Sample Time (Note 1, 18)	$t_{\text{MSR}}$	Standard speed	$t_{\text{RL}} + \delta$		15	$\mu\text{s}$
		Overdrive speed	$t_{\text{RL}} + \delta$		2	

## Electrical Characteristics (continued)

(Limits are 100% tested at  $T_A = +25^\circ\text{C}$ . Limits over the operating temperature range and relevant supply voltage range are guaranteed by design and characterization. Specifications marked GBD are guaranteed by design and not production tested. Specifications to the minimum and maximum operating temperature are guaranteed by design and are not production tested.)

PARAMETER	SYMBOL	CONDITIONS	MIN	TYP	MAX	UNITS
<b>GPIO PIN</b>						
GPIO Output Low	$PIOV_{OL}$	$PIOI_{OL} = 4\text{mA}$ (Note 10)			0.4	V
GPIO Input Low	$PIOV_{IL}$		-0.3	$0.15 \times V_{PUP}$		V
GPIO Master Sample	$PIOV_{IH}$		$0.70 \times V_{PUP}$		$V_{PUP} + 0.3$	V
GPIO Switching Hysteresis	$PIOV_{HY}$			0.3		V
GPIO Leakage Current	$PIOI_L$		-10		+10	$\mu\text{A}$
<b>STRONG PULLUP OPERATION</b>						
Strong Pullup Current	$I_{SPU}$	(Note 19)		11	15	mA
Strong Pullup Voltage	$V_{SPU}$	(Note 19)	2.8			V
Read Memory	$t_{RM}$				2	ms
Write Memory	$t_{WM}$				100	ms
Write State	$t_{WS}$				15	ms
Computation Time (HMAC)	$t_{CMP}$				4	ms
Generate ECC Key Pair	$t_{GKP}$				350	ms
Generate ECDSA Signature	$t_{GES}$				80	ms
Verify ECDSA Signature or Compute ECDH Time	$t_{VES}$				160	ms
TRNG Generation	$t_{RNG}$				40	ms
TRNG On-Demand Check	$t_{ODC}$				65	ms
<b>OTP</b>						
OTP Write Temperature	$T_{OPTW}$				50	$^\circ\text{C}$
Data Retention	$t_{DR}$	$T_A = +85^\circ\text{C}$ (Note 21)	10			Years
<b>POWER</b>						
Power-Up Time	$t_{OSCWUP}$	(Notes 1, 20)	2			ms

**Note 1:** System requirement.

**Note 2:** Maximum allowable pullup resistance is a function of the number of 1-Wire devices in the system and 1-Wire recovery times. The specified value here applies to systems with only one device and with the minimum 1-Wire recovery times.

**Note 3:** Value represents the internal parasite capacitance when  $V_{PUP}$  is first applied. Once the parasite capacitance is charged, it does not affect normal communication. Typically, during normal communication, the internal parasite capacitance is effectively  $\sim 100\text{pF}$ .

**Note 4:** Guaranteed by design and/or characterization only. Not production tested.

**Note 5:**  $V_{TL}$ ,  $V_{TH}$ , and  $V_{HY}$  are functions of the internal supply voltage, which is a function of  $V_{PUP}$ ,  $R_{PUP}$ , 1-Wire timing, and capacitive loading on IO. Lower  $V_{PUP}$ , higher  $R_{PUP}$ , shorter  $t_{REC}$ , and heavier capacitive loading all lead to lower values of  $V_{TL}$ ,  $V_{TH}$ , and  $V_{HY}$ .

**Note 6:** Voltage below which, during a falling edge on IO, a logic-zero is detected.

**Note 7:** The voltage on IO must be less than or equal to  $V_{ILMAX}$  at all times the master is driving IO to a logic-zero level.

**Note 8:** Voltage above which, during a rising edge on IO, a logic-one is detected.

**Note 9:** After  $V_{TH}$  is crossed during a rising edge on IO, the voltage on IO must drop by at least  $V_{HY}$  to be detected as logic-zero.

**Note 10:** The I-V characteristic is linear for voltages less than 1V.

**Note 11:** Applies to a single device attached to a 1-Wire line.

**Note 12:**  $t_{REC}$  min covers operation at worst-case temperature  $V_{PUP}$ ,  $R_{PUP}$ ,  $C_X$ ,  $t_{RSTL}$ ,  $t_{WOL}$ , and  $t_{RL}$ .  $t_{RECMIN}$  can be significantly reduced under less extreme conditions. Contact the factory for more information.

**Note 13:** The earliest recognition of a negative edge is possible at  $t_{REH}$  after  $V_{TH}$  has been previously reached.

**Note 14:** Defines maximum possible bit rate. Equal to  $1/(t_{WOLMIN} + t_{RECMIN})$ .

## Electrical Characteristics (continued)

(Limits are 100% tested at  $T_A = +25^\circ\text{C}$ . Limits over the operating temperature range and relevant supply voltage range are guaranteed by design and characterization. Specifications marked GBD are guaranteed by design and not production tested. Specifications to the minimum and maximum operating temperature are guaranteed by design and are not production tested.)

**Note 15:** Time from  $V_{(IO)} = 80\%$  of  $V_{PUP}$  and  $V_{(IO)} = 20\%$  of  $V_{PUP}$  at the negative edge on IO at the beginning of the presence detect pulse.

**Note 16:** Interval after  $t_{RSTL}$  during which a bus master can read a logic 0 on IO if there is a DS28E83 present.

**Note 17:**  $\epsilon$  in Figure 4 represents the time required for the pullup circuitry to pull the voltage on IO up from  $V_{IL}$  to  $V_{TH}$ .

**Note 18:**  $\delta$  in Figure 4 represents the time required for the pullup circuitry to pull the voltage on IO up from  $V_{IL}$  to the input-high threshold of the bus master.

**Note 19:**  $I_{SPU}$  is the current drawn from IO during a strong pullup (SPU) operation. The pullup circuit on IO during the SPU operation should be such that the voltage at IO is greater than or equal to  $V_{SPUMIN}$ . A low-impedance bypass of  $R_{PUP}$  activated during the SPU operation is the recommended way to meet this requirement.

**Note 20:** 1-Wire communication should not take place for at least  $t_{OSCWUP}$  after  $V_{PUP}$  reaches  $V_{PUP}$  min.

**Note 21:** Data retention is tested in compliance with JESD47G. No elevated gamma radiation level.

**Note 22:** Post radiation increases leakage current and requires long recovery times as noted.

## Pin Configuration

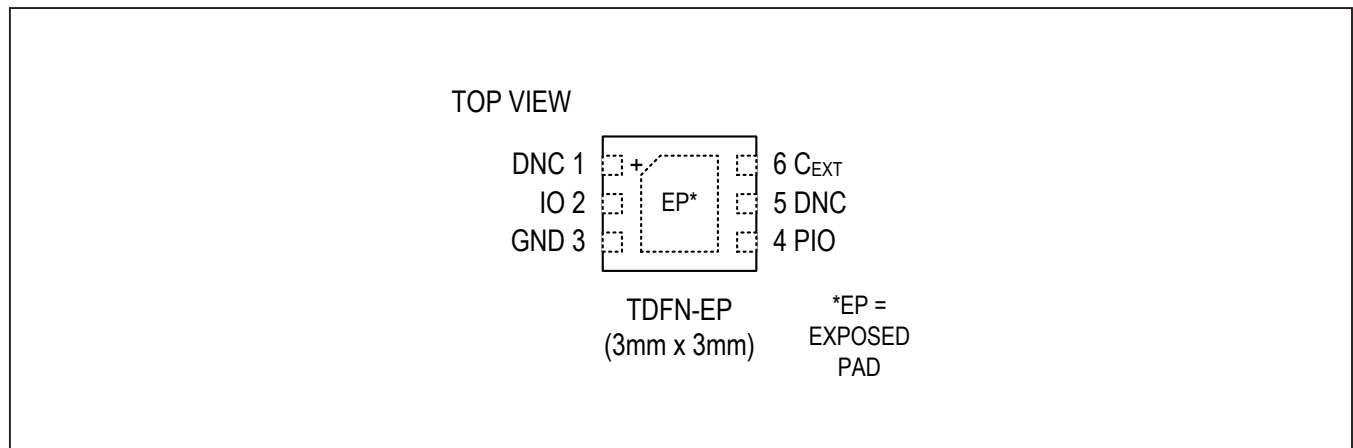

## Pin Description

PIN	NAME	FUNCTION
1, 5	DNC	Do Not Connect
2	IO	1-Wire IO
3	GND	Ground
4	PIO	General-Purpose IO
6	$C_{EXT}$	Input for External Capacitor
—	—	Exposed Pad (TDFN Only). Solder evenly to the board's ground plane for proper operation. Refer to Application Note 3273: <i>Exposed Pads: A Brief Introduction</i> for additional information.

**Detailed Description**

The DS28E83 is the first secure authenticator to integrate high radiation resistance. It provides a core set of cryptographic tools derived from integrated asymmetric (ECC-P256) and symmetric (SHA-256) security functions. In addition to the security services provided by the hardware implemented crypto engines, the device integrates a FIPS true random number generator (TRNG), 10Kb of secured OTP, one pin of configurable GPIO, and a unique 64-bit ROM identification number (ROM ID).

**Function Commands**

After a 1-Wire reset/presence cycle and ROM function command sequence is successful, a command start can be accepted and then followed by a device function command. In general, these commands follow the state flow diagram (Figure 1). Within this diagram, the data transfer is verified when writing and reading by a CRC of 16-bit type (CRC-16). The CRC-16 is computed as described in Application Note 27: *Understanding and Using Cyclic Redundancy Checks with Maxim 1-Wire and iButton Products*.

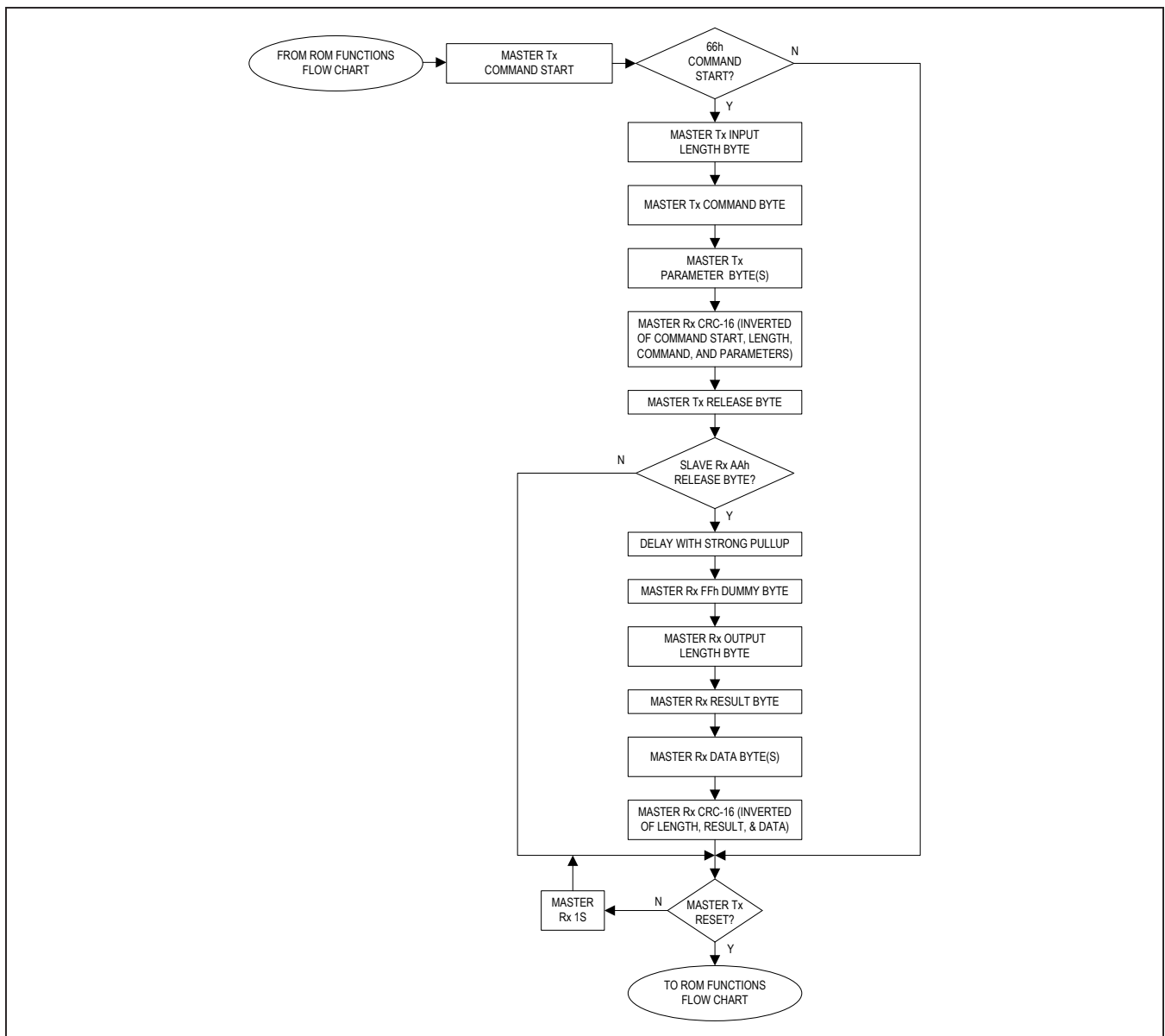

Figure 1. Device Function Flow Chart

**1-Wire Bus System**

The 1-Wire bus is a system that has a single bus master and one or more slaves. In all instances, the DS28E83 is a slave device. The bus master is typically a microcontroller. The discussion of this bus system is broken down into three topics: hardware configuration, transaction sequence, and 1-Wire signaling (signal types and timing). The 1-Wire protocol defines bus transactions in terms of the bus state during specific time slots that are initiated on the falling edge of sync pulses from the bus master.

**Hardware Configuration**

The 1-Wire bus has only a single line by definition; it is important that each device on the bus can drive it at the appropriate time. To facilitate this, each device attached to the 1-Wire bus must have open-drain or three-state outputs. The 1-Wire port of the DS28E83 is open drain with an internal circuit equivalent.

A multidrop bus consists of a 1-Wire bus with multiple slaves attached. The DS28E83 supports both a standard and overdrive communication speed of 11.7kbps (max) and 62.5kbps (max), respectively. The value of the pullup resistor primarily depends on the network size and load conditions. The DS28E83 requires a pullup resistor of 1kΩ (max) at any speed.

The idle state for the 1-Wire bus is high. If for any reason a transaction needs to be suspended, the bus must be left in the idle state if the transaction is to resume. If this does not occur and the bus is left low for more than 16μs (overdrive speed) or more than 120μs (standard speed), one or more devices on the bus could be reset.

**Transaction Sequence**

The protocol for accessing the DS28E83 through the 1-Wire port is as follows:

- Initialization
- ROM Function command
- Device Function command
- Transaction/data

**Initialization**

All transactions on the 1-Wire bus begin with an initialization sequence. The initialization sequence consists of a reset pulse transmitted by the bus master followed by presence pulse(s) transmitted by the slave(s). The presence pulse lets the bus master know that the DS28E83 is on the bus and is ready to operate. For more details, see the *1-Wire Signaling and Timing* section.

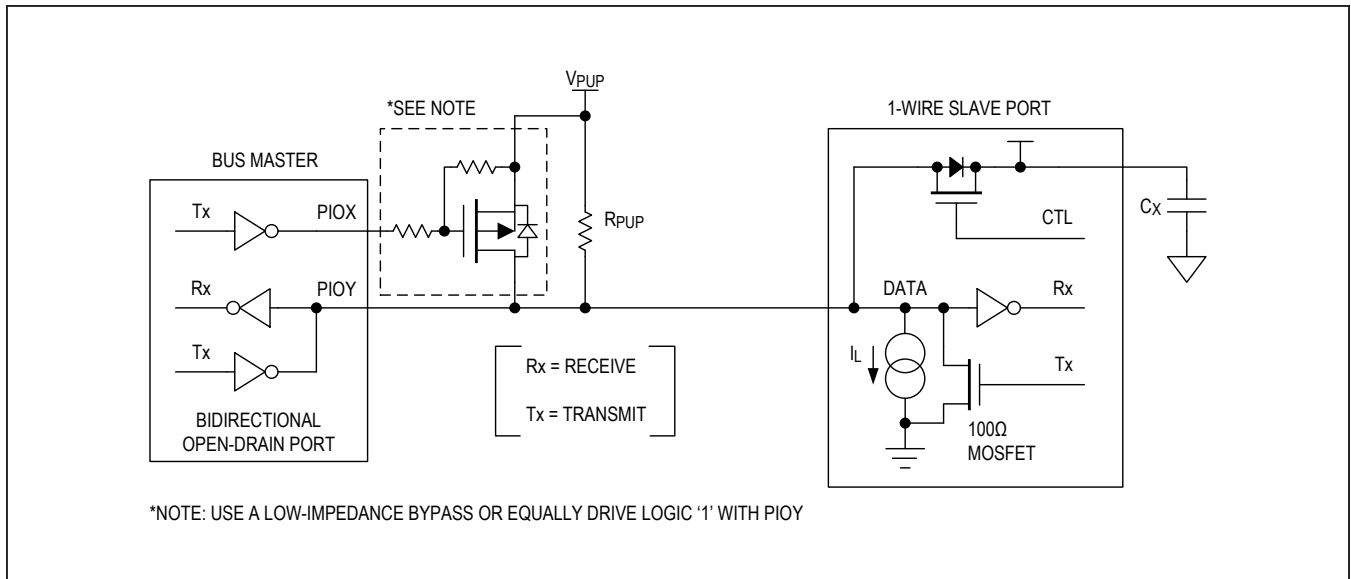

Figure 2. Hardware Configuration



**1-Wire Signaling and Timing**

The DS28E83 requires strict protocols to ensure data integrity. The protocol consists of four types of signaling on one line: reset sequence with reset pulse and presence pulse, write-zero, write-one, and read-data. Except for the presence pulse, the bus master initiates all falling edges. The DS28E83 can communicate at two speeds: standard and overdrive. If not explicitly set into the overdrive mode, the DS28E83 communicates at standard speed. While in overdrive mode, the fast timing applies to all waveforms.

To get from idle to active, the voltage on the 1-Wire line needs to fall from  $V_{PUP}$  below the threshold  $V_{TL}$ . To get from active to idle, the voltage needs to rise from  $V_{ILMAX}$  past the threshold  $V_{TH}$ . The time it takes for the voltage to make this rise is seen in Figure 3 as  $\epsilon$ , and its duration depends on the pullup resistor ( $R_{PUP}$ ) used and the capacitance of the 1-Wire network attached. The voltage  $V_{ILMAX}$  is relevant for the DS28E83 when determining a logical level, not triggering any events.

Figure 3 shows the initialization sequence required to begin any communication with the DS28E83. A reset pulse followed by a presence pulse indicates that the DS28E83 is ready to receive data, given the correct ROM and device

function command. If the bus master uses slew-rate control on the falling edge, it must pull down the line for  $t_{RSTL} + t_f$  to compensate for the edge. A  $t_{RSTL}$  duration of  $480\mu s$  or longer exits the overdrive mode, returning the device to standard speed. If the DS28E83 is in overdrive mode and  $t_{RSTL}$  is no longer than  $80\mu s$ , the device remains in overdrive mode. If the device is in overdrive mode and  $t_{RSTL}$  is between  $80\mu s$  and  $480\mu s$ , the device resets, but the communication speed is undetermined.

After the bus master has released the line, it goes into receive mode. Now the 1-Wire bus is pulled to  $V_{PUP}$  through the pullup resistor or, in the case of a special driver chip, through the active circuitry. When the threshold  $V_{TH}$  is crossed, the DS28E83 waits for  $t_{PDH}$  and then transmits a presence pulse by pulling the line low for  $t_{PDL}$ . To detect a presence pulse, the master must test the logical state of the 1-Wire line at  $t_{MSP}$ .

The  $t_{RSTH}$  window must be at least the sum of  $t_{PDHMAX}$ ,  $t_{PDLMAX}$ , and  $t_{RECMIN}$ . Immediately after  $t_{RSTH}$  is expired, the DS28E83 is ready for data communication. In a mixed population network,  $t_{RSTH}$  should be extended to minimum  $480\mu s$  at standard speed and  $48\mu s$  at overdrive speed to accommodate other 1-Wire devices.

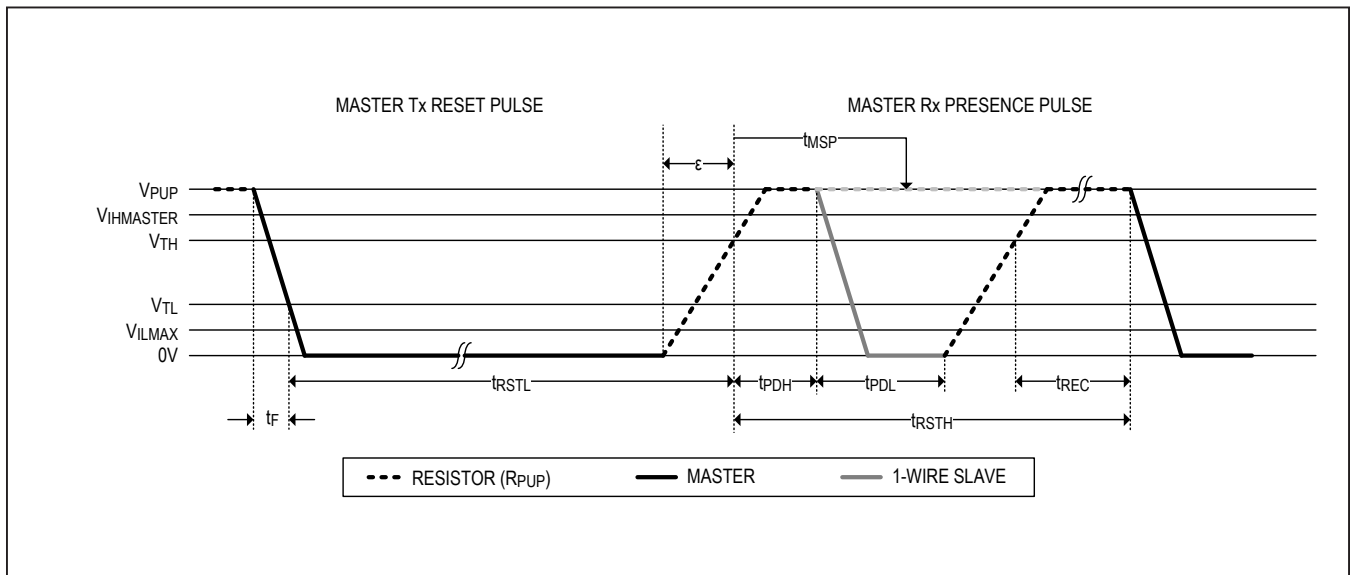

Figure 3. Initialization Procedure: Reset and Presence Pulse

### Read/Write Time Slots

Data communication with the DS28E83 takes place in time slots that carry a single bit each. Write time slots transport data from bus master to slave. Read time slots transfer data from slave to master. [Figure 4](#) illustrates the definitions of the write and read time slots.

All communication begins with the master pulling the data line low. As the voltage on the 1-Wire line falls below the threshold  $V_{TL}$ , the DS28E83 starts its internal timing generator that determines when the data line is sampled during a write time slot and how long data is valid during a read time slot.

### Master-to-Slave

For a write-one time slot, the voltage on the data line must have crossed the  $V_{TH}$  threshold before the write-one low time  $t_{W1LMAX}$  is expired. For a write-zero time slot, the voltage on the data line must stay below the  $V_{TH}$  threshold until the write-zero low time  $t_{W0LMIN}$  is expired. For the most reliable communication, the voltage on the data line should not exceed  $V_{ILMAX}$  during the entire  $t_{W0L}$  or  $t_{W1L}$  window. After the  $V_{TH}$  threshold has been crossed, the DS28E83 needs a recovery time  $t_{REC}$  before it is ready for the next time slot.

### Slave-to-Master

A read-data time slot begins like a write-one time slot. The voltage on the data line must remain below  $V_{TL}$  until the read low time  $t_{RL}$  is expired. During the  $t_{RL}$  window, when responding with a 0, the DS28E83 starts pulling the data line low; its internal timing generator determines when this pulldown ends and the voltage starts rising again. When responding with a 1, the DS28E83 does not hold the data line low at all, and the voltage starts rising as soon as  $t_{RL}$  is over.

The sum of  $t_{RL} + \delta$  (rise time) on one side and the internal timing generator of the DS28E83 on the other side define the master sampling window ( $t_{MSRMIN}$  to  $t_{MSRMAX}$ ), in which the master must perform a read from the data line. For the most reliable communication,  $t_{RL}$  should be as short as permissible, and the master should read close to but no later than  $t_{MSRMAX}$ . After reading from the data line, the master must wait until  $t_{SLOT}$  is expired. This guarantees sufficient recovery time  $t_{REC}$  for the DS28E83 to get ready for the next time slot. Note that  $t_{REC}$  specified herein applies only to a single DS28E83 attached to a 1-Wire line. For multidevice configurations,  $t_{REC}$  must be extended to accommodate the additional 1-Wire device input capacitance. Alternatively, an interface that performs active pullup during the 1-Wire recovery time such as the special 1-Wire line drivers can be used.

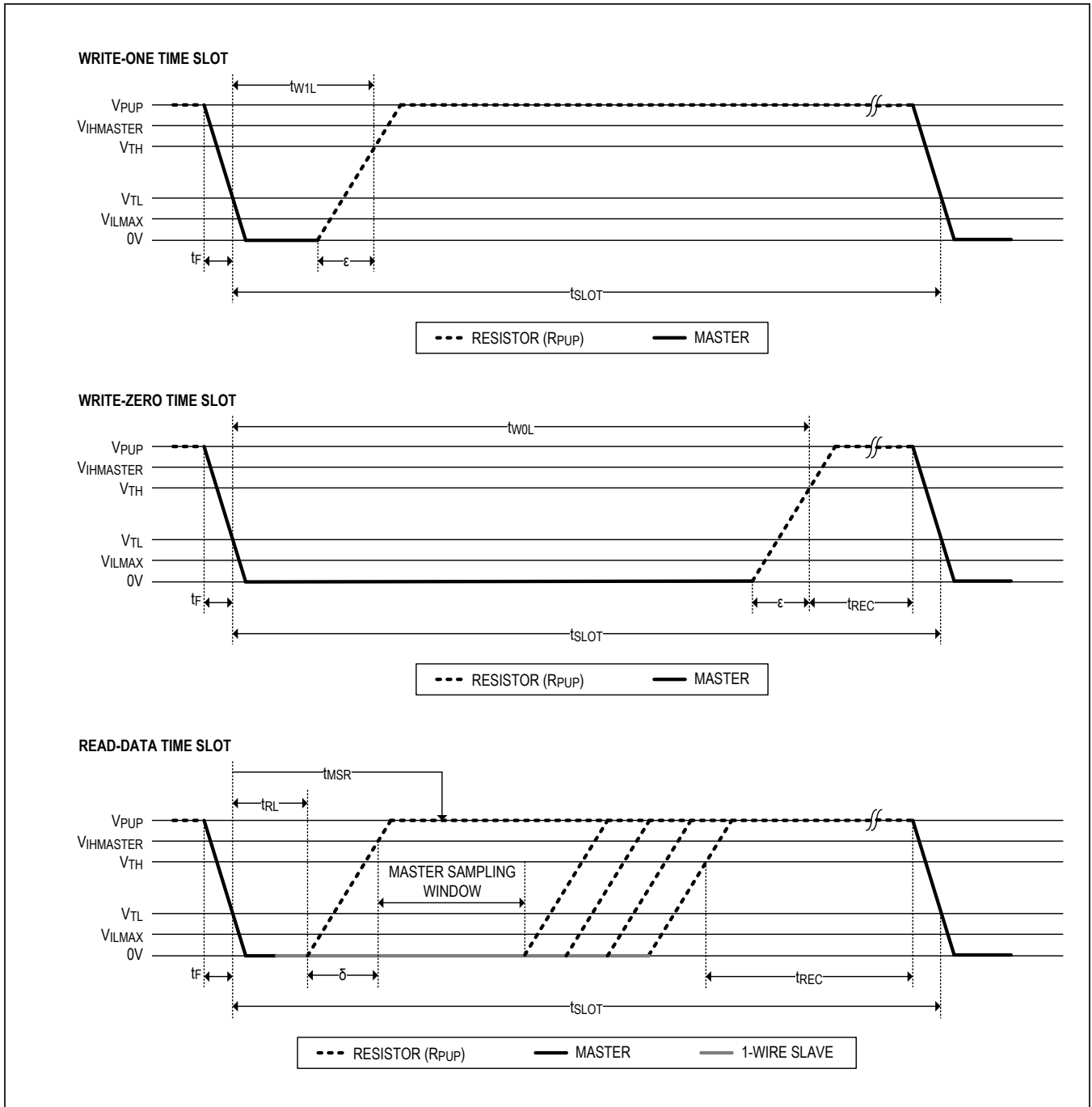

Figure 4. Read/Write Timing Diagrams

### 1-Wire ROM Commands

Once the bus master has detected a presence, it can issue one of the seven ROM function commands that the DS28E83 supports. All ROM function commands are 8 bits long. For operational details, see the flowchart description in [Figure 5](#) and [Figure 6](#). A descriptive list of these ROM function commands follows in the subsequent sections.

#### Read ROM[33h]

The Read ROM command allows the bus master to read the DS28E83's 8-bit family code, unique 48-bit serial number, and 8-bit CRC. This command can only be used if there is a single slave on the bus. If more than one slave is present on the bus, a data collision occurs when all slaves try to transmit at the same time (open drain produces a wired-AND result). The resultant family code and 48-bit serial number result in a mismatch of the CRC.

#### Match ROM[55h]

The Match ROM command, followed by a 64-bit ROM sequence, allows the bus master to address a specific DS28E83 on a multidrop bus. Only the DS28E83 that exactly matches the 64-bit ROM sequence responds to the subsequent device function command. All other slaves wait for a reset pulse. This command can be used with a single device or multiple devices on the bus.

#### Search ROM[F0h]

When a system is initially brought up, the bus master might not know the number of devices on the 1-Wire bus or their ROM ID numbers. By taking advantage of the wired-AND property of the bus, the master can use a process of elimination to identify the ID of all slave devices. For each bit in the ID number, starting with the least significant bit, the bus master issues a triplet of time slots. On the first slot, each slave device participating in the search outputs the true value of its ID number bit. On the second slot, each slave device participating in the search outputs the complemented value of its ID number bit. On the third slot, the master writes the true value of the bit to be selected. All slave devices that do not match the bit written by the master stop participating in the search. If both of the read bits are zero, the master knows that slave devices exist with both states of the bit. By choosing which state to write, the bus master branches in the search tree. After one complete pass, the bus master knows the ROM ID number of a single device. Additional passes identify the ID numbers of the remaining devices. Refer to Application Note 187: *1-Wire Search Algorithm* for a detailed discussion, including an example.

#### Skip ROM [CCh]

This command can save time in a single-drop bus system by allowing the bus master to access the device functions without providing the 64-bit ROM ID. If more than one slave is present on the bus and, for example, a read command is issued following the Skip ROM command, data collision occurs on the bus as multiple slaves transmit simultaneously (open-drain pulldowns produce a wired-AND result).

#### Resume [A5h]

To maximize the data throughput in a multidrop environment, the Resume command is available. This command checks the status of the RC bit and, if it is set, directly transfers control to the device function commands, similar to a Skip ROM command. The only way to set the RC bit is through successfully executing the Match ROM, Search ROM, or Overdrive-Match ROM command. Once the RC bit is set, the device can repeatedly be accessed through the Resume command. Accessing another device on the bus clears the RC bit, preventing two or more devices from simultaneously responding to the Resume command.

#### Overdrive-Skip ROM [3Ch]

On a single-drop bus this command can save time by allowing the bus master to access the device functions without providing the 64-bit ROM ID. Unlike the normal Skip ROM command, the Overdrive-Skip ROM command sets the DS28E83 into the overdrive mode ( $OD = 1$ ). All communication following this command must occur at overdrive speed until a reset pulse of minimum 480 $\mu$ s duration resets all devices on the bus to standard speed ( $OD = 0$ ).

When issued on a multidrop bus, this command sets all overdrive-supporting devices into overdrive mode. To subsequently address a specific overdrive-supporting device, a reset pulse at overdrive speed must be issued followed by a Match ROM or Search ROM command sequence. This speeds up the time for the search process. If more than one slave supporting overdrive is present on the bus and the Overdrive-Skip ROM command is followed by a read command, data collision occurs on the bus as multiple slaves transmit simultaneously (open-drain pulldowns produce a wired-AND result).

#### Overdrive-Match ROM [69h]

The Overdrive-Match ROM command followed by a 64-bit ROM sequence transmitted at overdrive speed allows the bus master to address a specific DS28E83 on a multidrop bus and to simultaneously set it in overdrive mode. Only the DS28E83 that exactly matches the 64-bit ROM

sequence responds to the subsequent device function command. Slaves already in overdrive mode from a previous Overdrive-Skip ROM or successful Overdrive-Match ROM command remain in overdrive mode. All overdrive-

capable slaves return to standard speed at the next reset pulse of minimum 480µs duration. The Overdrive-Match ROM command can be used with a single device or multiple devices on the bus.

**ROM Command Flow**

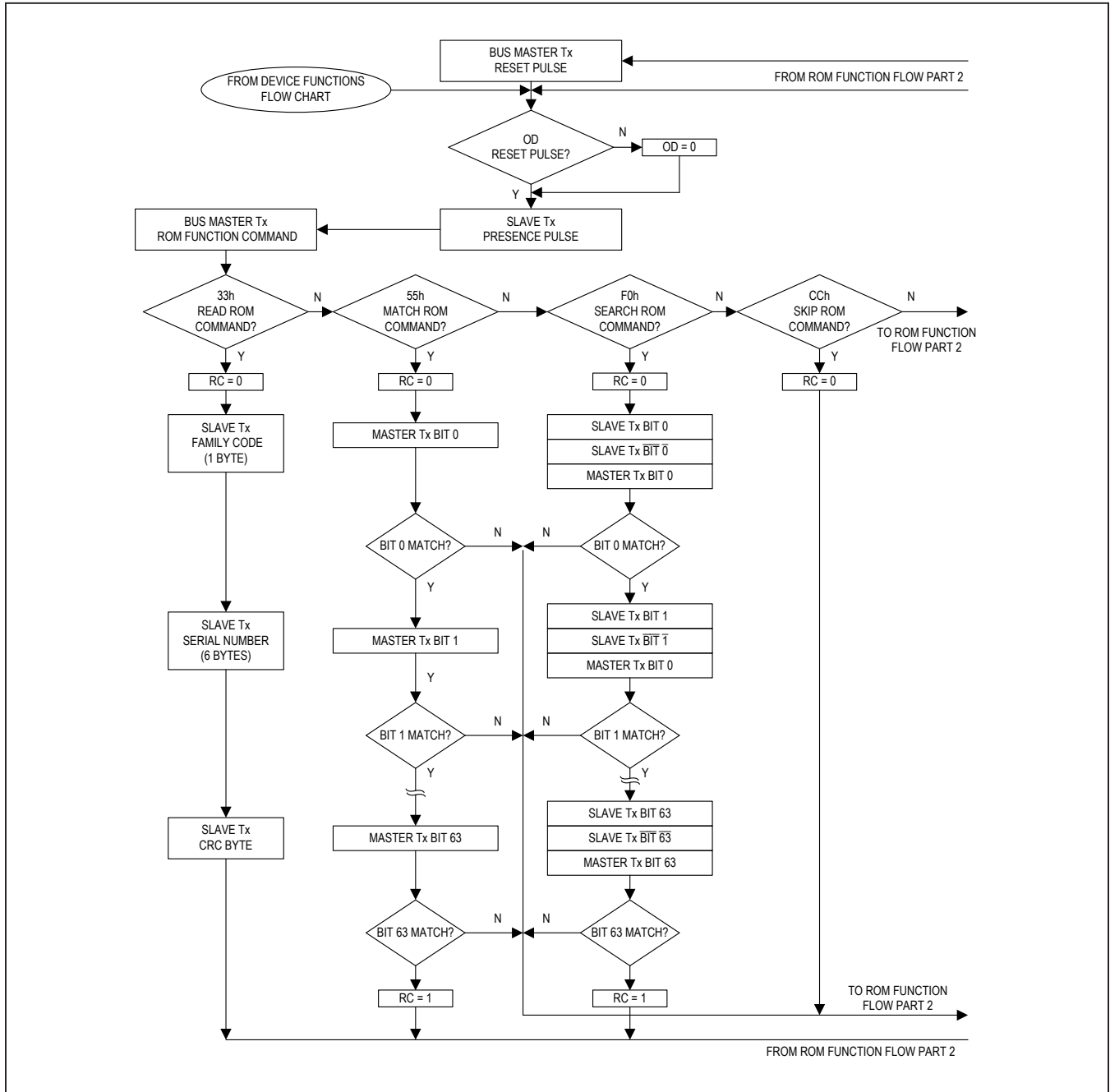

Figure 5. ROM Function Flow (Part 1)

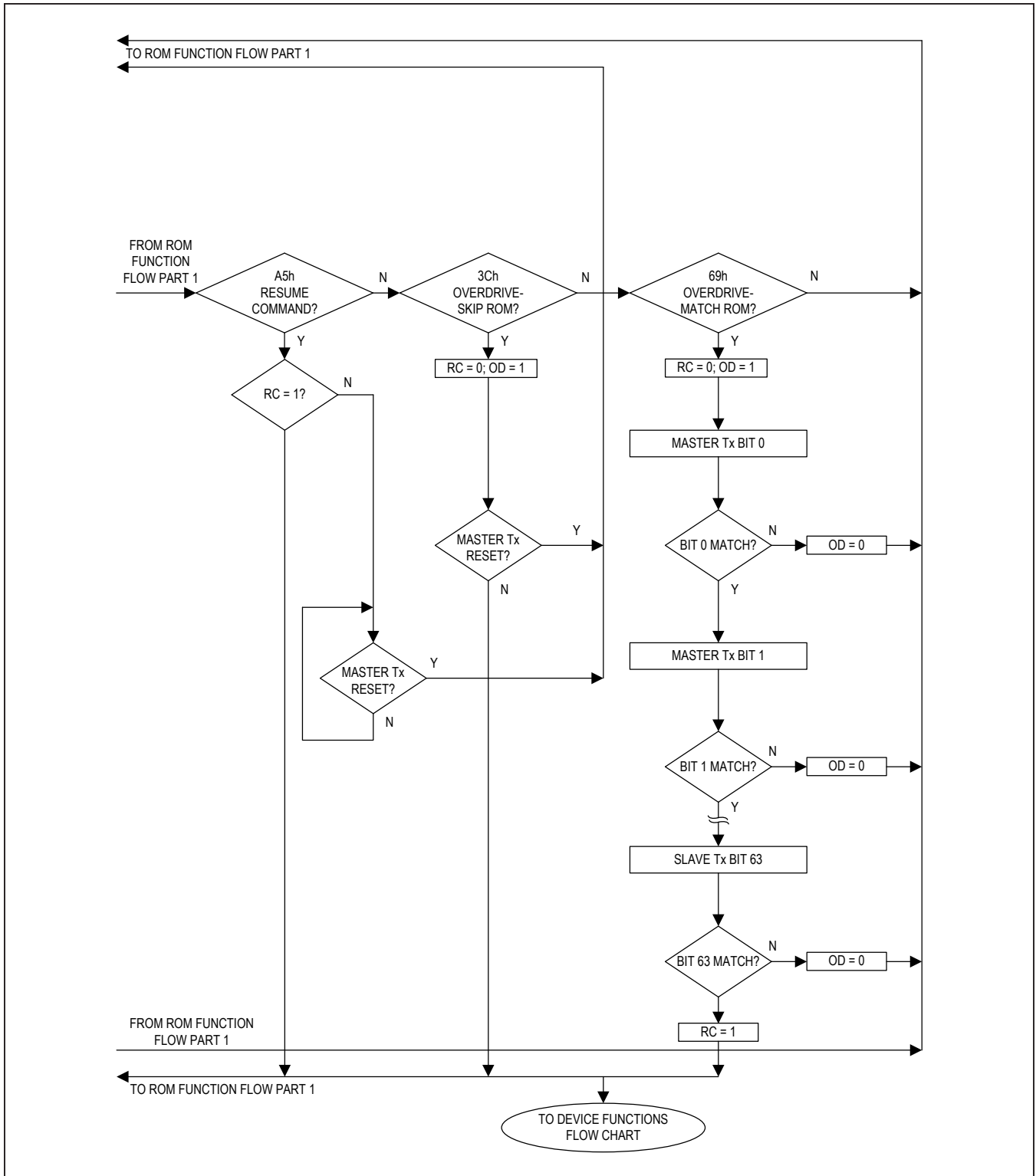

Figure 6. ROM Function (Part 2)

### Improved Network Behavior (Switch-Point Hysteresis)

In a 1-Wire environment, line termination is possible only during transients controlled by the bus master (1-Wire driver). 1-Wire networks, therefore, are susceptible to noise of various origins. Depending on the physical size and topology of the network, reflections from end points and branch points can add up or cancel each other to some extent. Such reflections are visible as glitches or ringing on the 1-Wire communication line. Noise coupled onto the 1-Wire line from external sources can also result in signal glitching. A glitch during the rising edge of a time slot can cause a slave device to lose synchronization with the master and, consequently, result in a Search ROM command coming to a dead end or cause a device-specific function command to abort. For better performance in network applications, the DS28E83 uses a 1-Wire front-end that is less sensitive to noise.

The DS28E83's 1-Wire front end has the following features:

- The falling edge of the presence pulse has a controlled slew rate to reduce ringing. The slew rate control is specified by  $t_{FPD}$ .
- There is a hysteresis at the low-to-high switching threshold  $V_{TH}$ . If a negative glitch crosses  $V_{TH}$ , but does not go below  $V_{TH} - V_{HY}$ , it is not recognized (Figure 7, Case A). The hysteresis is effective at any 1-Wire speed.
- There is a time window specified by the rising edge hold-off time  $t_{REH}$  during which glitches are ignored, even if they extend below the  $V_{TH} - V_{HY}$  threshold (Figure 7, Case B,  $t_{GL} < t_{REH}$ ). Deep voltage drops or glitches that appear late after crossing the  $V_{TH}$  threshold and extend beyond the  $t_{REH}$  window cannot be filtered out and are taken as the beginning of a new time slot (Figure 7, Case C,  $t_{GL} \geq t_{REH}$ ).

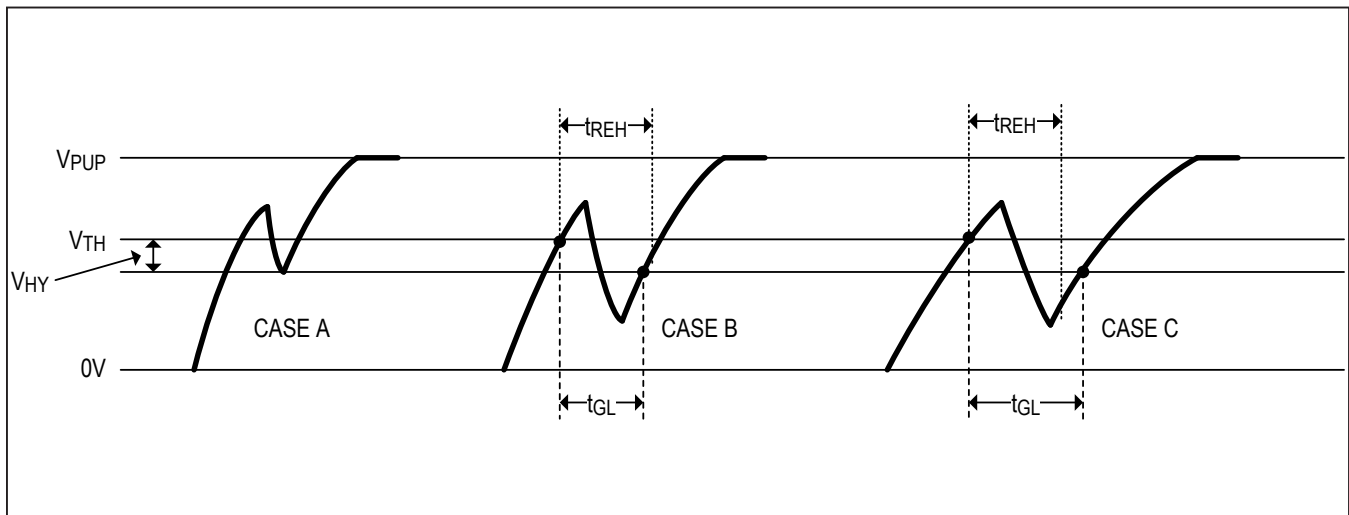
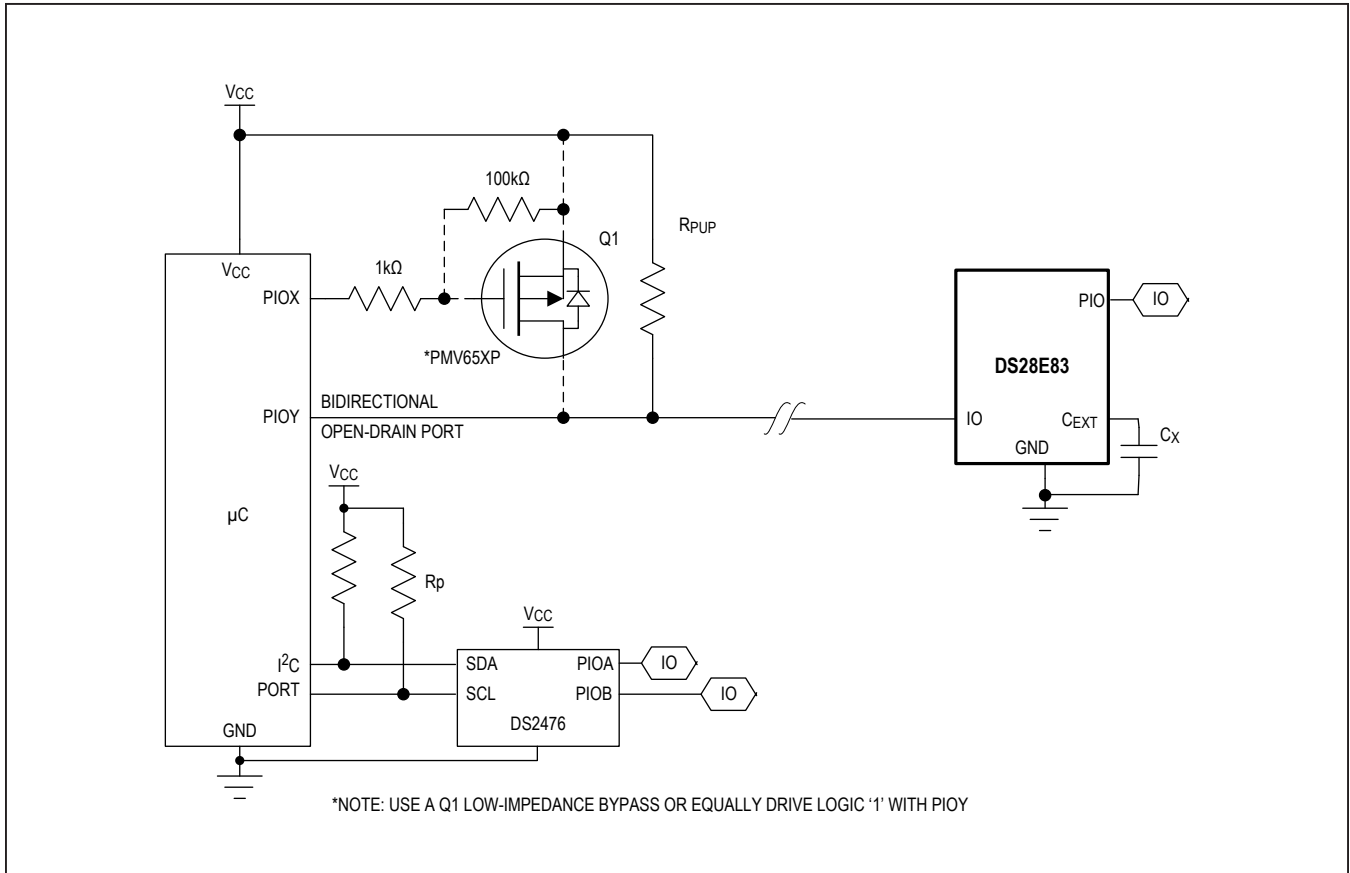

Figure 7. Noise Suppression Scheme

Typical Application Circuit



Ordering Information

PART	TEMP RANGE	PIN-PACKAGE
DS28E83Q+T	0°C to +50°C	6 TDFN-EP (2.5k pcs reel)

+Denotes a lead(Pb)-free/RoHS-compliant package.

T = Tape and reel.



## Revision History

REVISION NUMBER	REVISION DATE	DESCRIPTION	PAGES CHANGED
0	3/18	Initial release	—
0.1		Added Security User Guide button	1

For pricing, delivery, and ordering information, please contact Maxim Direct at 1-888-629-4642, or visit Maxim Integrated's website at [www.maximintegrated.com](http://www.maximintegrated.com).

*Maxim Integrated cannot assume responsibility for use of any circuitry other than circuitry entirely embodied in a Maxim Integrated product. No circuit patent licenses are implied. Maxim Integrated reserves the right to change the circuitry and specifications without notice at any time. The parametric values (min and max limits) shown in the Electrical Characteristics table are guaranteed. Other parametric values quoted in this data sheet are provided for guidance.*